

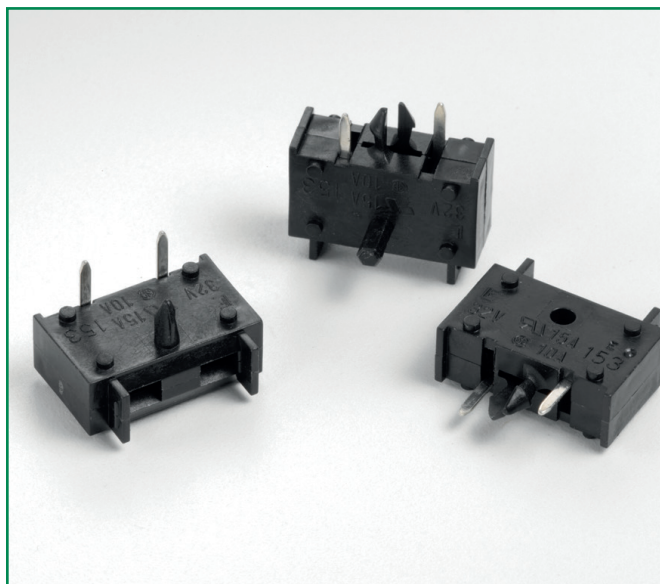

THE DATASHEET OF
01530032Z



PCB MOUNT FUSE HOLDER FOR MINI® STYLE BLADE FUSE



Specifications

Max Voltage Rating:	32V
Max Current Rating:	UL: 20A UR: 15A CSA: 10A
Approvals:	UL Listed UL Recognized CSA Certified (File: 007316_0_000)
Body Material:	Thermoplastic UL 94-V0, heat-resistant
Clip Material:	Copper alloy, Tin-plated finish

Description

The MINI® Fuse PCB Fuse Holders bring the reliability and availability of the plug-in 32V MINI® Fuse to the circuit board. Vertical and horizontal mounting of units is offered. The Fuse Holder has “standoffs” to accommodate board washing and incorporates a unique “board lock” anchor to maintain a firm mechanical bond to the PCB.

Dimensions on page 2

Ordering Information

PART NUMBER	VOLTAGE	AMPERAGE			PACKAGE SIZE	DESCRIPTION
		UL	UR	CSA		
01530007LXN	32V		15A	10A	50	Horizontal Mount
01530007Z		20A	15A	10A	500	
01530008LXN			15A	10A	50	Single Vertical Mount (or End Unit)
01530008Z		20A	15A	10A	500	
01530009LXN			15A	10A	50	Stackable Vertical Mount
01530009Z		20A	15A	10A	500	

PCB MOUNT FUSE HOLDER FOR MINI® STYLE BLADE FUSE

01530007_

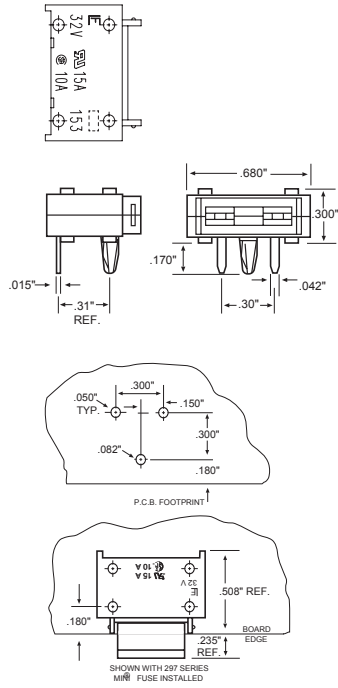

01530008_

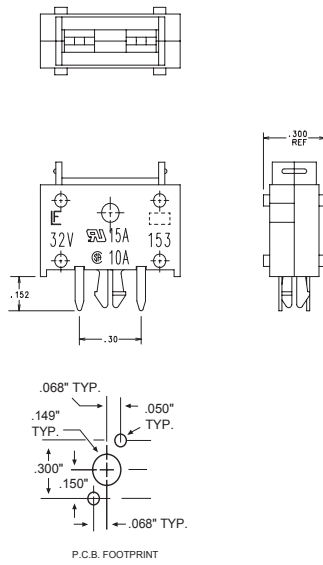

01530009_

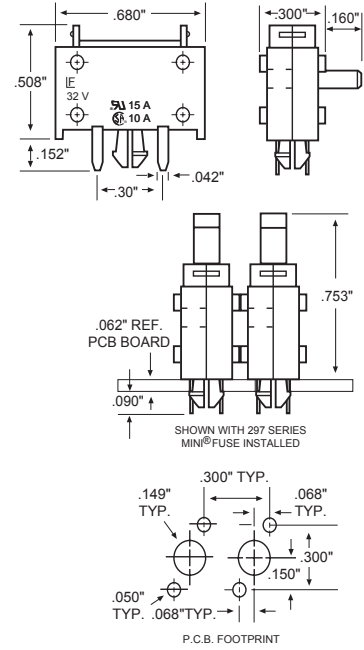

01530031_

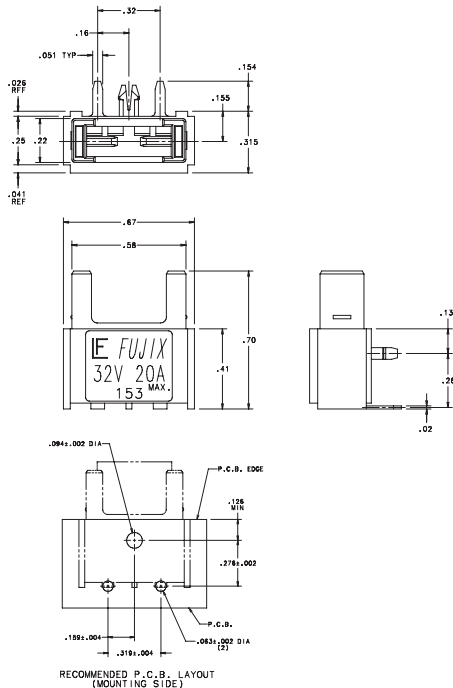

01530032_

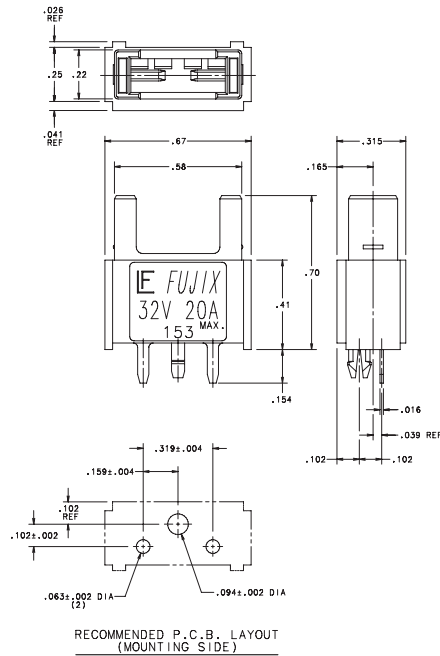

01530033_

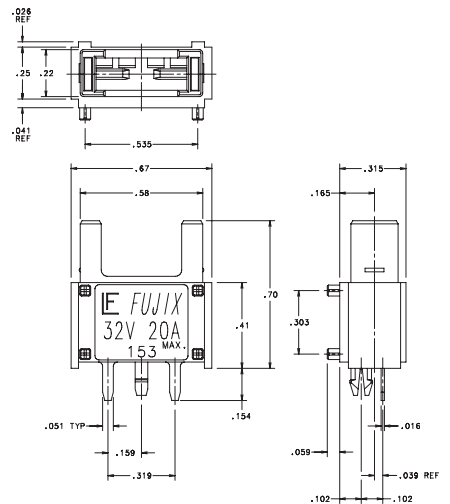

Looking for pricing, stock, or lifecycle information?

Click below to explore more details on WIN SOURCE:

 [View 01530032Z on WIN SOURCE](#)

 [Littelfuse Inc. Information](#)

Optimize Your Supply Chain with WIN SOURCE Solutions

-  Global Sourcing Solution
-  Obsolete Management
-  Cost Control Management
-  Shortage Management
-  Alternative Solution
-  Excess Inventory Management