



**THE DATASHEET OF  
DG412DY-T1**





# Precision Monolithic Quad SPST CMOS Analog Switches

## FEATURES

- 44-V Supply Max Rating
- $\pm 15$ -V Analog Signal Range
- On-Resistance— $r_{DS(on)}$ : 25  $\Omega$
- Fast Switching— $t_{ON}$ : 110 ns
- Ultra Low Power— $P_D$ : 0.35  $\mu$ W
- TTL, CMOS Compatible
- Single Supply Capability

## BENEFITS

- Widest Dynamic Range
- Low Signal Errors and Distortion
- Break-Before-Make Switching Action
- Simple Interfacing

## APPLICATIONS

- Precision Automatic Test Equipment
- Precision Data Acquisition
- Communication Systems
- Battery Powered Systems
- Computer Peripherals

## DESCRIPTION

The DG411 series of monolithic quad analog switches was designed to provide high speed, low error switching of precision analog signals. Combining low power (0.35  $\mu$ W) with high speed ( $t_{ON}$ : 110 ns), the DG411 family is ideally suited for portable and battery powered industrial and military applications.

Each switch conducts equally well in both directions when on, and blocks input voltages up to the supply levels when off.

The DG411 and DG412 respond to opposite control logic as shown in the Truth Table. The DG413 has two normally open and two normally closed switches.

To achieve high-voltage ratings and superior switching performance, the DG411 series was built on Vishay Siliconix's high voltage silicon gate process. An epitaxial layer prevents latchup.

## FUNCTIONAL BLOCK DIAGRAM AND PIN CONFIGURATION

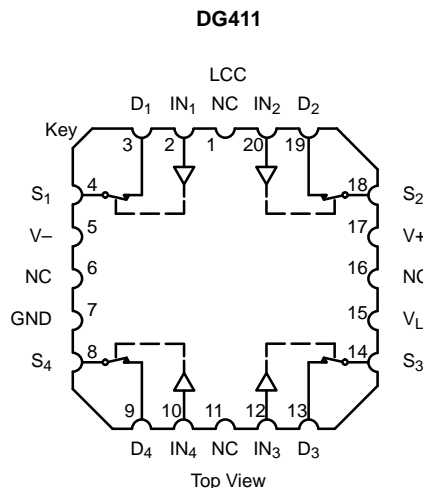
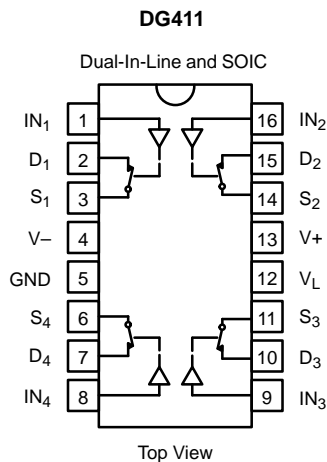

TRUTH TABLE		
Logic	DG411	DG412
0	ON	OFF
1	OFF	ON

Logic "0"  $\leq 0.8$  V  
Logic "1"  $\geq 2.4$  V

### FUNCTIONAL BLOCK DIAGRAM AND PIN CONFIGURATION

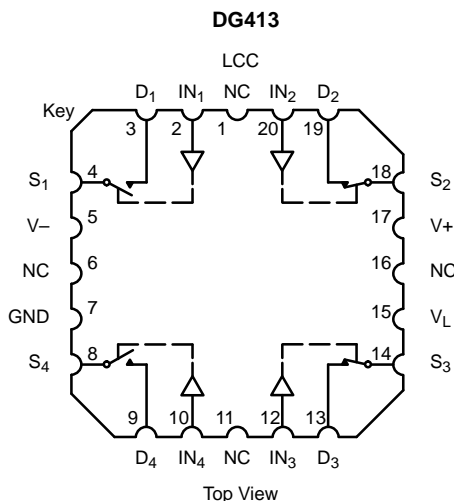
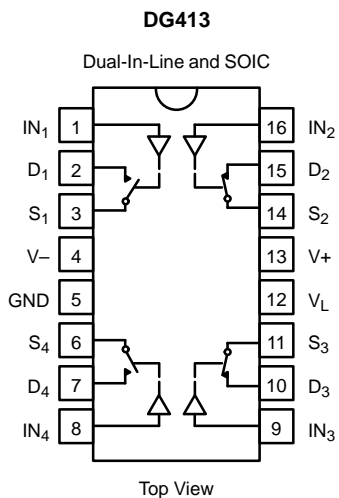

TRUTH TABLE		
Logic	SW <sub>1</sub> , SW <sub>4</sub>	SW <sub>2</sub> , SW <sub>3</sub>
0	OFF	ON
1	ON	OFF

Logic "0" ≤ 0.8 V  
Logic "1" ≥ 2.4 V

ORDERING INFORMATION		
Temp Range	Package	Part Number
<b>DG411/412</b>		
-40 to 85°C	16-Pin Plastic DIP	DG411DJ
		DG412DJ
-40 to 85°C	16-Pin Narrow SOIC	DG411DY
		DG412DY
-55 to 125°C	16-Pin CerDIP	DG411AK, DG411AK/883, 5962-9073101MEA
		DG412AK, DG412AK/883, 5962-9073102MEA
	LCC-20	DG411AZ/883, 5962-9073101M2A
		5962-9073102M2A
<b>DG413</b>		
-40 to 85°C	16-Pin Plastic DIP	DG413DJ
	16-Pin Narrow SOIC	DG413DY
-55 to 125°C	16-Pin CerDIP	DG413AK, DG413AK/883, 5962-9073103MEA
	LCC-20	5962-9073103M2A

### ABSOLUTE MAXIMUM RATINGS

V+ to V-	44 V
GND to V-	25 V
V <sub>L</sub>	(GND -0.3 V) to (V+) +0.3 V
Digital Inputs <sup>a</sup> , V <sub>S</sub> , V <sub>D</sub>	(V-) -2 V to (V+) +2 V or 30 mA, whichever occurs first
Continuous Current (Any Terminal)	30 mA
Peak Current, S or D (Pulsed 1 ms, 10% Duty Cycle)	100 mA
Storage Temperature (AK, AZ Suffix)	-65 to 150°C
(DJ, DY Suffix)	-65 to 125°C

Power Dissipation (Package) <sup>b</sup>	
16-Pin Plastic DIP <sup>c</sup>	470 mW
16-Pin Narrow SOIC <sup>d</sup>	600 mW
16-Pin CerDIP <sup>e</sup>	900 mW
LCC-20 <sup>e</sup>	900 mW

#### Notes:

- Signals on S<sub>X</sub>, D<sub>X</sub>, or IN<sub>X</sub> exceeding V+ or V- will be clamped by internal diodes. Limit forward diode current to maximum current ratings.
- All leads welded or soldered to PC Board.
- Derate 6 mW/°C above 25°C
- Derate 7.6 mW/°C above 75°C
- Derate 12 mW/°C above 75°C



SPECIFICATIONS <sup>a</sup>									
Parameter	Symbol	Test Conditions Unless Specified  V <sub>+</sub> = 15 V, V <sub>-</sub> = -15 V V <sub>L</sub> = 5 V, V <sub>IN</sub> = 2.4 V, 0.8 V <sup>f</sup>	Temp <sup>b</sup>	Typ <sup>c</sup>	A Suffix -55 to 125°C		D Suffix -40 to 85°C		Unit
					Min <sup>d</sup>	Max <sup>d</sup>	Min <sup>d</sup>	Max <sup>d</sup>	
<b>Analog Switch</b>									
Analog Signal Range <sup>e</sup>	V <sub>ANALOG</sub>		Full		-15	15	-15	15	V
Drain-Source On-Resistance	r <sub>DS(on)</sub>	V <sub>+</sub> = 13.5 V, V <sub>-</sub> = -13.5 V I <sub>S</sub> = -10 mA, V <sub>D</sub> = ± 8.5 V	Room Full	25		35 45		35 45	Ω
Switch Off Leakage Current	I <sub>S(off)</sub>	V <sub>+</sub> = 16.5 V, V <sub>-</sub> = -16.5 V V <sub>D</sub> = ± 15.5 V, V <sub>S</sub> = ∓ 15.5 V	Room Full	± 0.1	-0.25 -20	0.25 20	-0.25 -5	0.25 5	nA
	I <sub>D(off)</sub>		Room Full	± 0.1	-0.25 -20	0.25 20	-0.25 -5	0.25 5	
Channel On Leakage Current	I <sub>D(on)</sub>	V <sub>+</sub> = 16.5 V, V <sub>-</sub> = -16.5 V V <sub>S</sub> = V <sub>D</sub> = ± 15.5 V	Room Full	± 0.1	-0.4 -40	0.4 40	-0.4 -10	0.4 10	
<b>Digital Control</b>									
Input Current, V <sub>IN</sub> Low	I <sub>IL</sub>	V <sub>IN</sub> Under Test = 0.8 V	Full	0.005	-0.5	0.5	-0.5	0.5	μA
Input Current, V <sub>IN</sub> High	I <sub>IH</sub>	V <sub>IN</sub> Under Test = 2.4 V	Full	0.005	-0.5	0.5	-0.5	0.5	
<b>Dynamic Characteristics</b>									
Turn-On Time	t <sub>ON</sub>	R <sub>L</sub> = 300 Ω, C <sub>L</sub> = 35 pF V <sub>S</sub> = ± 10 V See Figure 2	Room Full	110		175 240		175 220	ns
Turn-Off Time	t <sub>OFF</sub>		Room Full	100		145 160		145 160	
Break-Before-Make Time Delay	t <sub>D</sub>	DG413 Only, V <sub>S</sub> = 10 V R <sub>L</sub> = 300 Ω, C <sub>L</sub> = 35 pF	Room	25					
Charge Injection	Q	V <sub>g</sub> = 0 V, R <sub>g</sub> = 0 Ω, C <sub>L</sub> = 10 nF	Room	5					pC
Off Isolation <sup>e</sup>	OIRR	R <sub>L</sub> = 50 Ω, C <sub>L</sub> = 5 pF, f = 1 MHz	Room	68					dB
Channel-to-Channel Cross-talk <sup>e</sup>	X <sub>TALK</sub>		Room	85					
Source Off Capacitance <sup>e</sup>	C <sub>S(off)</sub>	f = 1 MHz	Room	9					pF
Drain Off Capacitance <sup>e</sup>	C <sub>D(off)</sub>		Room	9					
Channel On Capacitance <sup>e</sup>	C <sub>D(on)</sub>		Room	35					
<b>Power Supplies</b>									
Positive Supply Current	I <sub>+</sub>	V <sub>+</sub> = 16.5 V, V <sub>-</sub> = -16.5 V V <sub>IN</sub> = 0 or 5 V	Room Full	0.0001		1 5		1 5	μA
Negative Supply Current	I <sub>-</sub>		Room Full	-0.0001	-1 -5		-1 -5		
Logic Supply Current	I <sub>L</sub>		Room Full	0.0001		1 5		1 5	
Ground Current	I <sub>GND</sub>		Room Full	-0.0001	-1 -5		-1 -5		



### SPECIFICATIONS<sup>a</sup> FOR UNIPOLAR SUPPLIES

Parameter	Symbol	Test Conditions Unless Specified $V_+ = 12\text{ V}, V_- = 0\text{ V}$ $V_L = 5\text{ V}, V_{IN} = 2.4\text{ V}, 0.8\text{ V}^f$	Temp <sup>b</sup>	Typ <sup>c</sup>	A Suffix -55 to 125°C		D Suffix -40 to 85°C		Unit
					Min <sup>d</sup>	Max <sup>d</sup>	Min <sup>d</sup>	Max <sup>d</sup>	
<b>Analog Switch</b>									
Analog Signal Range <sup>e</sup>	$V_{ANALOG}$		Full			12		12	V
Drain-Source On-Resistance	$r_{DS(on)}$	$V_+ = 10.8\text{ V}, I_S = -10\text{ mA}$ $V_D = 3\text{ V}, 8\text{ V}$	Room Full	40		80 100		80 100	$\Omega$
<b>Dynamic Characteristics</b>									
Turn-On Time	$t_{ON}$	$R_L = 300\ \Omega, C_L = 35\text{ pF}$ $V_S = 8\text{ V}, \text{ See Figure 2}$	Room Hot	175		250 400		250 315	ns
Turn-Off Time	$t_{OFF}$		Room Hot	95		125 140		125 140	
Break-Before-Make Time Delay	$t_D$	DG413 Only, $V_S = 8\text{ V}$ , $R_L = 300\ \Omega, C_L = 35\text{ pF}$	Room	25					
Charge Injection	Q	$V_g = 6\text{ V}, R_g = 0\ \Omega, C_L = 10\text{ nF}$	Room	25					pC
<b>Power Supplies</b>									
Positive Supply Current	$I_+$	$V_+ = 13.5\text{ V}, V_{IN} = 0\text{ or }5\text{ V}$	Room Hot	0.0001		1 5		1 5	$\mu\text{A}$
Negative Supply Current	$I_-$		Room Hot	-0.0001	-1 -5		-1 -5		
Logic Supply Current	$I_L$		Room Hot	0.0001		1 5		1 5	
Ground Current	$I_{GND}$		Room Hot	-0.0001	-1 -5		-1 -5		

**Notes:**

- Refer to PROCESS OPTION FLOWCHART.
- Room = 25°C, Full = as determined by the operating temperature suffix.
- Typical values are for DESIGN AID ONLY, not guaranteed nor subject to production testing.
- The algebraic convention whereby the most negative value is a minimum and the most positive a maximum, is used in this data sheet.
- Guaranteed by design, not subject to production test.
- $V_{IN}$  = input voltage to perform proper function.

### TYPICAL CHARACTERISTICS (25°C UNLESS NOTED)

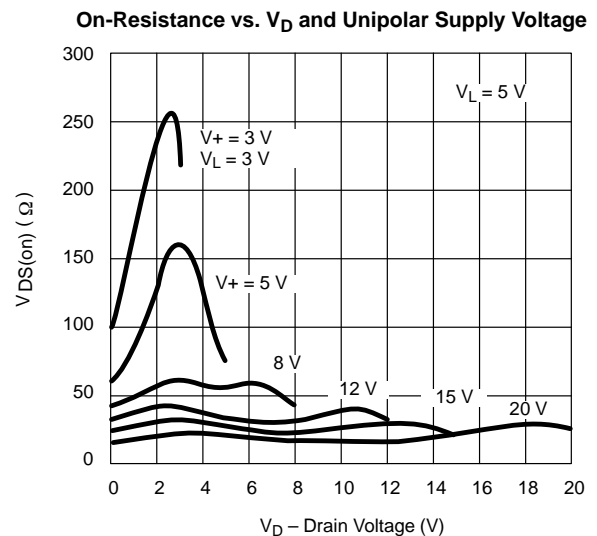
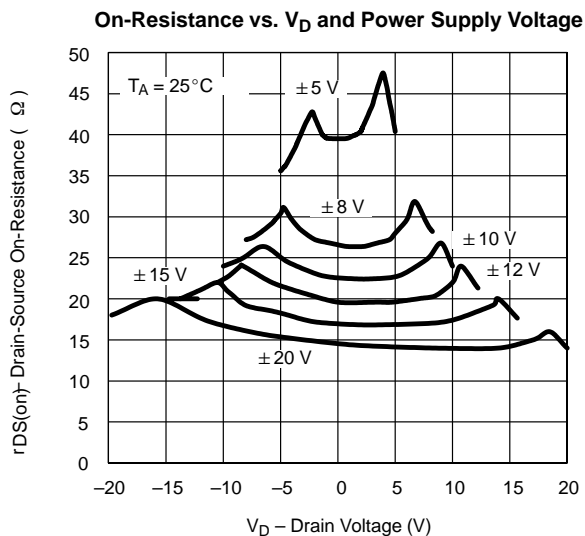

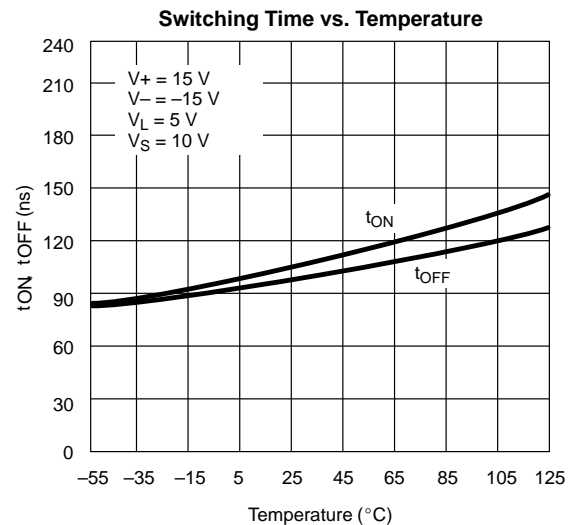
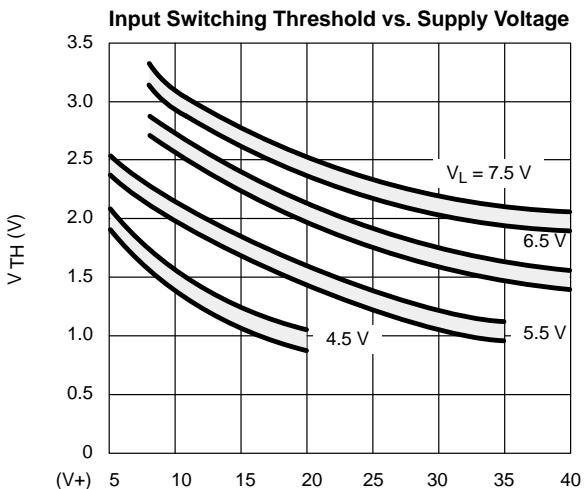
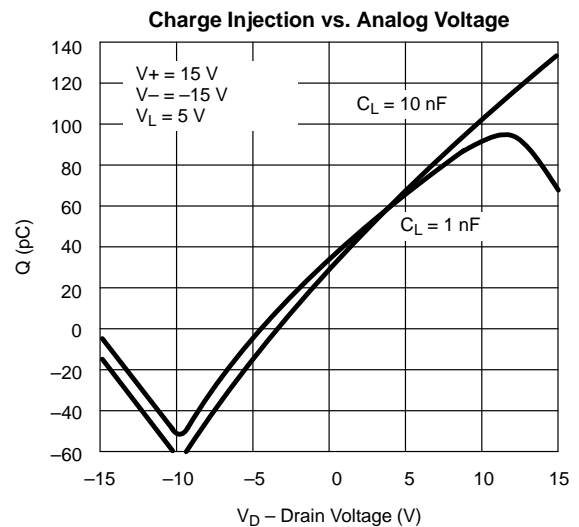
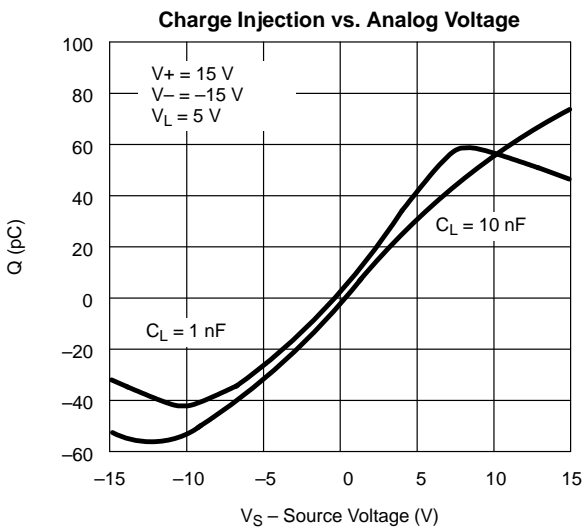
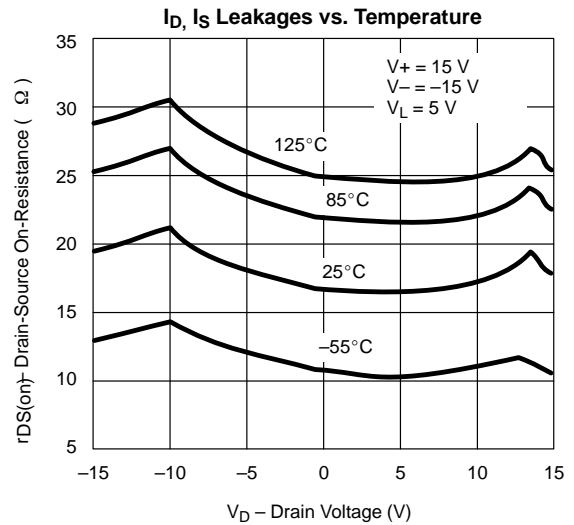
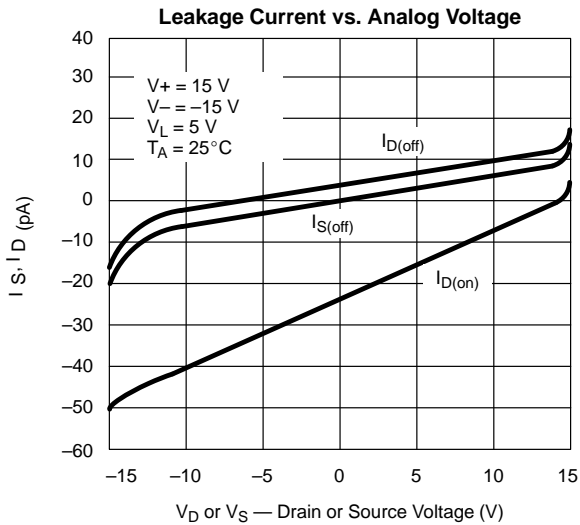
**TYPICAL CHARACTERISTICS (25°C UNLESS NOTED)**

**TYPICAL CHARACTERISTICS (25°C UNLESS NOTED)**

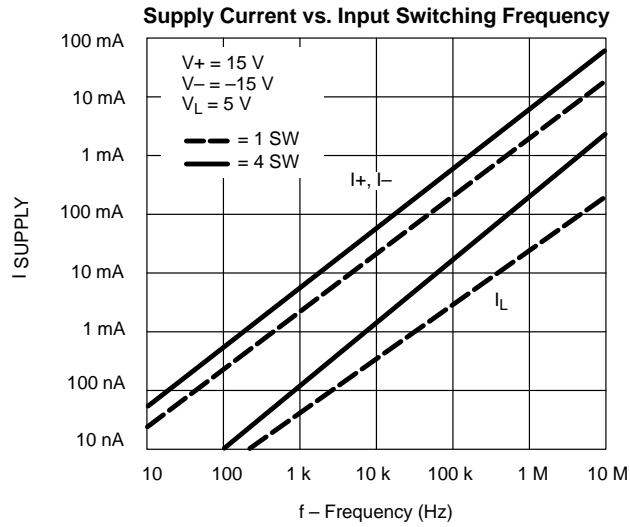

**SCHEMATIC DIAGRAM (TYPICAL CHANNEL)**

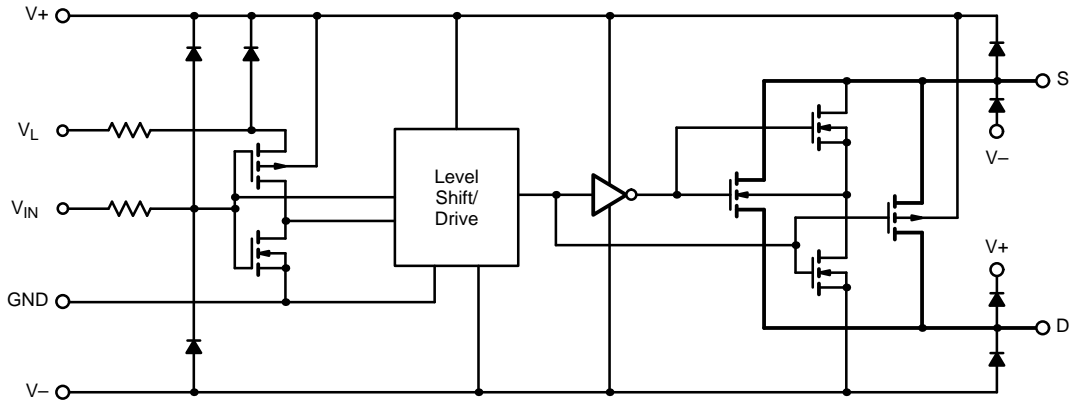
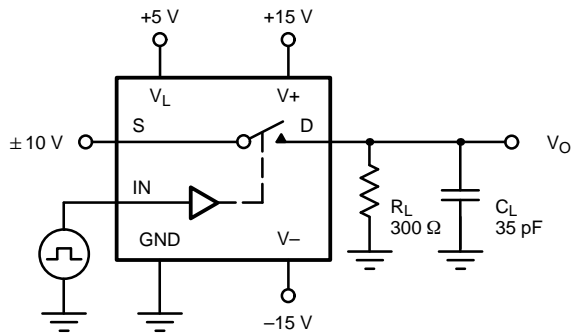

FIGURE 1.

**TEST CIRCUITS**



$C_L$  (includes fixture and stray capacitance)

$$V_O = V_S \frac{R_L}{R_L + r_{DS(on)}}$$

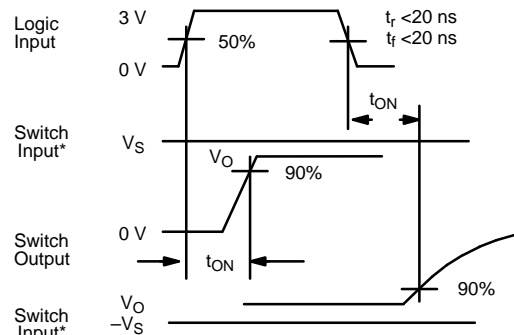

\* $V_S = 10\text{ V}$  for  $t_{ON}$ ,  $V_S = -10\text{ V}$  for  $t_{OFF}$

Note: Logic input waveform is inverted for switches that have the opposite logic sense control

FIGURE 2. Switching Time

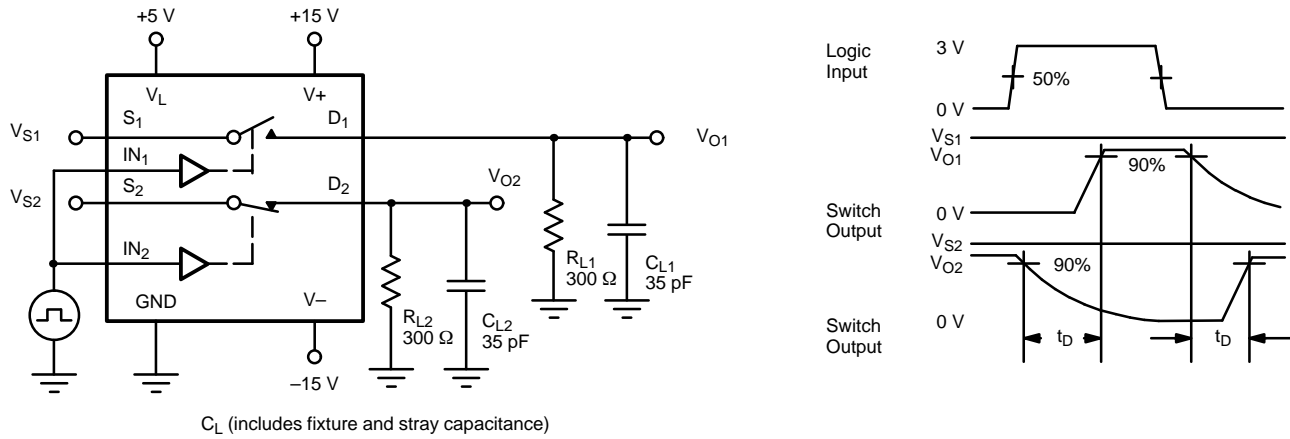
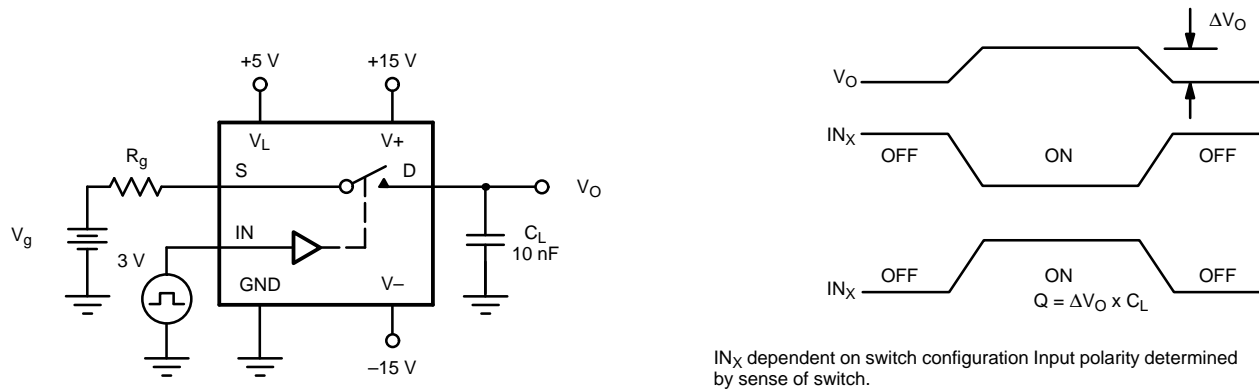
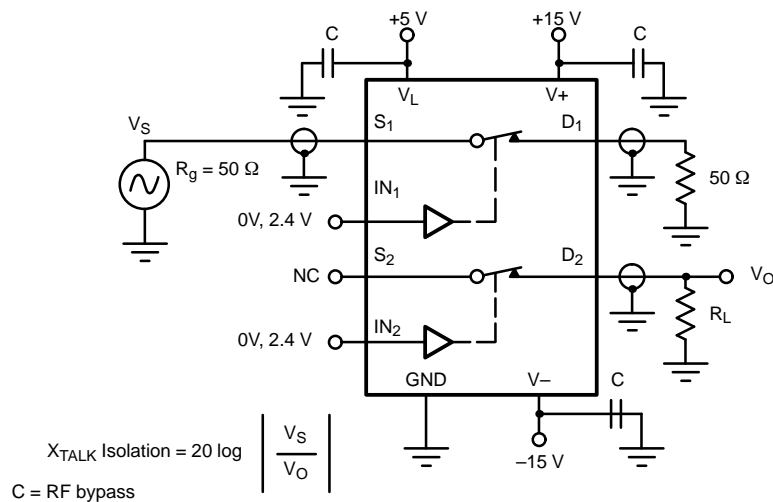
**TEST CIRCUITS**

**FIGURE 3. Break-Before-Make (DG413)**

**FIGURE 4. Charge Injection**

**FIGURE 5. Crosstalk**

**TEST CIRCUITS**

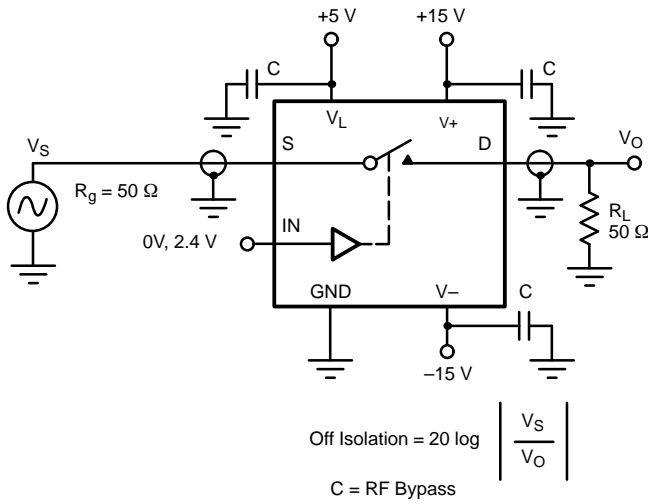

FIGURE 6. Off Isolation

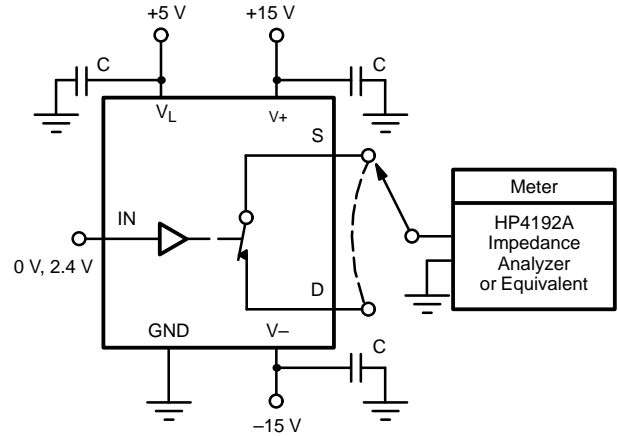

FIGURE 7. Source/Drain Capacitances

**APPLICATIONS**

**Single Supply Operation:**

The DG411/412/413 can be operated with unipolar supplies from 5 V to 44 V. These devices are characterized and tested for unipolar supply operation at 12 V to facilitate the majority of applications. In single supply operation, V+ is tied to VL and V- is tied to 0 V. See Input Switching Threshold vs. Supply Voltage curve for VL versus input threshold requirements.

**Summing Amplifier**

When driving a high impedance, high capacitance load such as shown in Figure 8, where the inputs to the summing amplifier have some noise filtering, it is necessary to have shunt switches for rapid discharge of the filter capacitor, thus preventing offsets from occurring at the output.

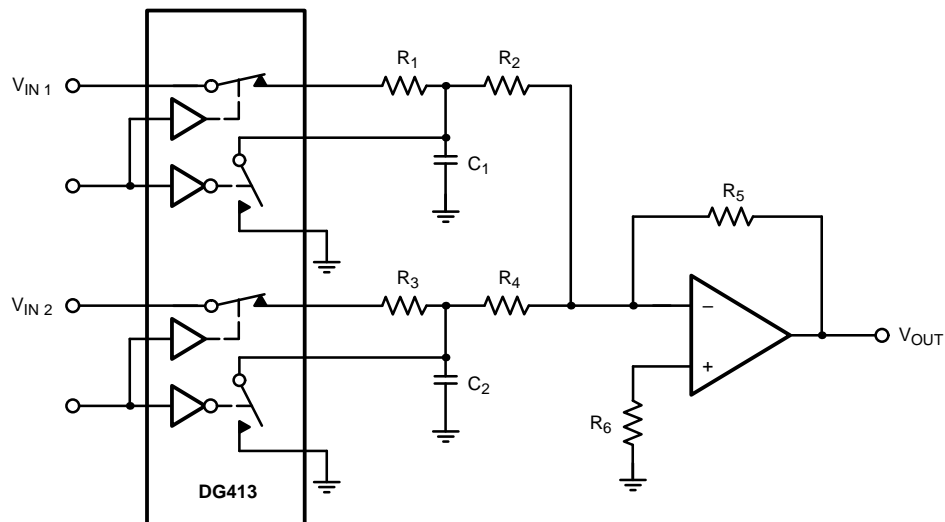

FIGURE 8. Summing Amplifier



## Notice

Specifications of the products displayed herein are subject to change without notice. Vishay Intertechnology, Inc., or anyone on its behalf, assumes no responsibility or liability for any errors or inaccuracies.

Information contained herein is intended to provide a product description only. No license, express or implied, by estoppel or otherwise, to any intellectual property rights is granted by this document. Except as provided in Vishay's terms and conditions of sale for such products, Vishay assumes no liability whatsoever, and disclaims any express or implied warranty, relating to sale and/or use of Vishay products including liability or warranties relating to fitness for a particular purpose, merchantability, or infringement of any patent, copyright, or other intellectual property right.

The products shown herein are not designed for use in medical, life-saving, or life-sustaining applications. Customers using or selling these products for use in such applications do so at their own risk and agree to fully indemnify Vishay for any damages resulting from such improper use or sale.

## Looking for pricing, stock, or lifecycle information?

Click below to explore more details on WIN SOURCE:

 [View DG412DY-T1 on WIN SOURCE](#)

 [Vishay Information](#)

## Optimize Your Supply Chain with WIN SOURCE Solutions

-  Global Sourcing Solution
-  Obsolete Management
-  Cost Control Management
-  Shortage Management
-  Alternative Solution
-  Excess Inventory Management