

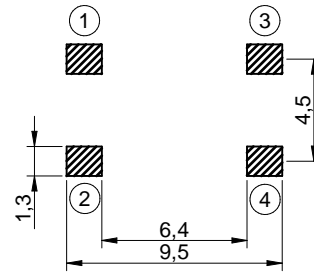

THE DATASHEET OF
430182043816

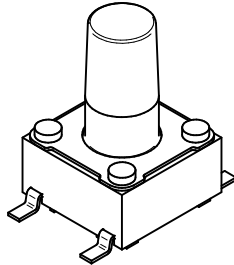

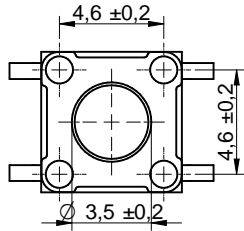
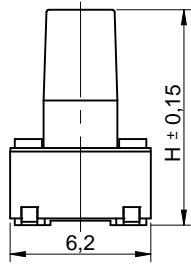
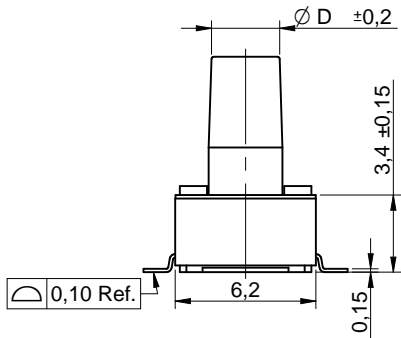
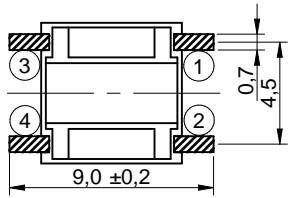

P.C.B. MOUNTING PLAN

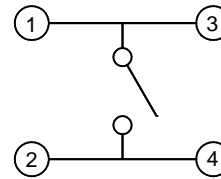

SCHEMATIC

TECHNICAL CHARACTERISTICS

SPECIFICATION

- >Rating: 50mA, 12VDC
- >Contact Resistance: Initial: 100mOHM max. After Life Test: 20HM max.
- >Insulation Resistance: min. 100MOHM at 500VDC
- >Dielectric Strength: 250VAC for 1 minute
- >Stroke: 0.25 ± 0.15mm
- >Bounce: 10ms max.

MATERIAL

- >Cover: Stainless Steel
- >Stem: LCP UL 94V-0
- >Frame: LCP UL 94V-0, color Black
- >Contact: Stainless Steel with silver
- >Terminal: Brass with silver plating

SOLDERING INFORMATION

- >Terminal in SMD version
- >Reflow soldering according to JEDEC J-STD 020 Hot Air
- >Hand soldering under 350°C for 3 sec. max

ENVIRONMENTAL

- >Storage condition: -40°C ~ +85°C
- >Operation condition: -40°C ~ +85°C
- >Compliance: Lead Free, ROHS, Reach

PACKAGING INFORMATION

>Tape & Reel

PN	Force	Color of Stem	Life cycle	-043		-050		-070		-080		-095		-130	
				H	Ø D	H	Ø D	H	Ø D	H	Ø D	H	Ø D	H	Ø D
430 182 xxx 816	160g ± 50gf	Black	1.000.000	4.3	3.5	5.0	3.5	7.0	3.0	8.0	3.0	9.5	3.0	13.0	3.0
430 152 xxx 826	260g ± 50gf	White	200.000												
430 152 xxx 836	360g ± 50gf	Salmon	200.000												

Scale - 3:1

This electronic component is designed and developed with the intention for use in general electronics equipments.

Before incorporating the components into any equipments in the field such as aerospace, aviation, nuclear control, submarine, transportation, (automotive control, train control, ship control), transportation signal, disaster prevention, medical, public information network etc. where higher safety and reliability are especially required or if there is possibility of direct damage or injury to human body, Würth Elektronik must be asked for a written approval.

In addition, even electronic component in general electronic equipments, when used in electrical circuits that require high safety, reliability functions or performance, the sufficient reliability evaluation-check for the safety must be performed before by the user before usage.

				GENERAL TOLERANCE .x = +/- 0,2 .xx = +/- 0,15		Basic material	
				Date	Name	DESCRIPTION	
e	remove Contact cladding	14-10-30	DaF	Drawn 09-09-15	Jelisarow	WS-TASV 6x6mm Tact Switch, SMD version	
d	revised MatchCode	14-07-24	AL				
c	Bounce 10ms max.	14-04-11	DaF			Scale 3:1	Position
b	new values in chart	12-09-13	WJ		Würth Elektronik eiCan		SIZE
a	warning text	11-10-28	WJ		Drawing.- No. 4301x2xxx8x6		A4
REV	FILE	DATE	BY	EDV NO	4301x2xxx8x6.dft		System :Solid Edge V20

Looking for pricing, stock, or lifecycle information?

Click below to explore more details on WIN SOURCE:

 [View 430182043816 on WIN SOURCE](#)

 [Wurth Electronics Inc Information](#)

Optimize Your Supply Chain with WIN SOURCE Solutions

-  Global Sourcing Solution
-  Obsolete Management
-  Cost Control Management
-  Shortage Management
-  Alternative Solution
-  Excess Inventory Management