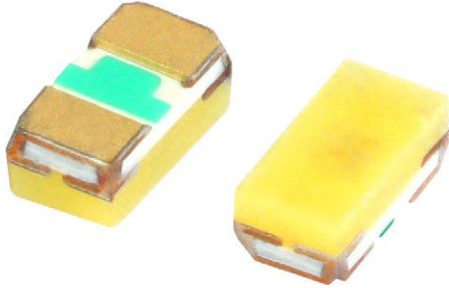




**THE DATASHEET OF
VLMW1500-GS08**



Ultrabright 0402 ChipLED



DESCRIPTION

The new 0402 ChipLED series has been designed in the smallest SMD package. This innovative 0402 ChipLED technology opens the way to

- Smaller products of higher performance
- More design-in flexibility
- Enhanced applications

The 0402 LED is an obvious solution for small-scale products that are expected to work reliably in an arduous environment.

This package is filled with a mixture of epoxy and yellow converter.

The yellow converter converts the blue emission partially to yellow, which mixes with the remaining blue to give white.

PRODUCT GROUP AND PACKAGE DATA

- Product group: LED
- Package: SMD 0402 ChipLED
- Product series: standard
- Angle of half intensity: $\pm 65^\circ$

FEATURES

- High efficient InGaN technology
- Super thin ChipLED with exceptional brightness 1.0 mm x 0.5 mm x 0.35 mm (L x W x H)
- High reliability, PCB based
- Temperature range -30°C to $+80^\circ\text{C}$
- Chromaticity coordinates categorized according to CIE 1931 per packing unit
- Typical color temperature 7000 K
- EIA standard package
- Compatible to IR reflow soldering
- Available on 7" diameter reel
- Preconditioning according to JEDEC® level 2a
- ESD-sensitive device
- Material categorization: for definitions of compliance please see www.vishay.com/doc?99912



APPLICATIONS

- Telecommunication: indicator and backlighting in telephone and fax
- Backlighting for audio and video equipment
- Backlighting in office equipment
- Indoor and outdoor message boards
- Flat backlight for LCDs, switches, and symbols

PARTS TABLE														
PART	COLOR	LUMINOUS INTENSITY (mcd)			at I _F (mA)	COORDINATE (x, y)			at I _F (mA)	FORWARD VOLTAGE (V)			at I _F (mA)	TECHNOLOGY
		MIN.	TYP.	MAX.		MIN.	TYP.	MAX.		MIN.	TYP.	MAX.		
VLMW1500-GS08	White	45	90	180	5	-	0.304, 0.300	-	5	2.65	2.90	3.05	5	InGaN / yellow converter
VLMW1501-GS08	White	71	90	180	5	-	0.294, 0.286	-	5	2.65	2.90	3.05	5	InGaN / yellow converter
VLMW1502-GS08	White	71	90	180	5	-	0.314, 0.315	-	5	2.65	2.90	3.05	5	InGaN / yellow converter
VLMW1503-GS08	White	71	90	180	5	-	0.304, 0.300	-	5	2.65	2.90	3.05	5	InGaN / yellow converter



ABSOLUTE MAXIMUM RATINGS ($T_{amb} = 25\text{ }^{\circ}\text{C}$, unless otherwise specified)				
VLMW15..				
PARAMETER	TEST CONDITION	SYMBOL	VALUE	UNIT
DC forward current	$T_{amb} \leq 25\text{ }^{\circ}\text{C}$	I_F	20	mA
Surge forward current	$t_p \leq 10\text{ }\mu\text{s}$	I_{FSM}	0.1	A
Power dissipation		P_V	70	mW
Operating temperature range		T_{amb}	-30 to +80	$^{\circ}\text{C}$
Storage temperature range		T_{stg}	-55 to +105	$^{\circ}\text{C}$
Thermal resistance junction/ambient		R_{thJA}	550	K/W

OPTICAL AND ELECTRICAL CHARACTERISTICS ($T_{amb} = 25\text{ }^{\circ}\text{C}$, unless otherwise specified)							
VLMW15.., WHITE							
PARAMETER	TEST CONDITION	TYPE	SYMBOL	MIN.	TYP.	MAX.	UNIT
Luminous intensity	$I_F = 5\text{ mA}$	VLMW1500	I_V	45	90	180	mcd
		VLMW1501	I_V	71	90	180	mcd
		VLMW1502	I_V	71	90	180	mcd
		VLMW1503	I_V	71	90	180	mcd
Chromatically coordinate x acc. to CIE 1931	$I_F = 5\text{ mA}$	VLMW1500, VLMW1503	x	-	0.304	-	
Chromatically coordinate y acc. to CIE 1931	$I_F = 5\text{ mA}$	VLMW1500, VLMW1503	y	-	0.300	-	
Chromatically coordinate x acc. to CIE 1931	$I_F = 5\text{ mA}$	VLMW1501	x	-	0.294	-	
Chromatically coordinate y acc. to CIE 1931	$I_F = 5\text{ mA}$		y	-	0.286	-	
Chromatically coordinate x acc. to CIE 1931	$I_F = 5\text{ mA}$	VLMW1502	x	-	0.314	-	
Chromatically coordinate y acc. to CIE 1931	$I_F = 5\text{ mA}$		y	-	0.315	-	
Angle of half intensity	$I_F = 5\text{ mA}$		ϕ	-	± 65	-	$^{\circ}$
Forward voltage	$I_F = 5\text{ mA}$		V_F	2.65	2.90	3.05	V
Reverse current ⁽¹⁾	$V_R = 5\text{ V}$		I_R	-	10	-	μA

Note

⁽¹⁾ Driving the LED in reverse direction is suitable for short term application

LUMINOUS INTENSITY CLASSIFICATION		
GROUP	LUMINOUS INTENSITY (mcd) at 5 mA	
	MIN.	MAX.
P	45	71
Q	71	112
R	112	180

Note

- Luminous intensity is tested at a current pulse duration of 25 ms and an accuracy of $\pm 15\%$. The above type numbers represent the order groups which include only a few brightness groups. Only one group will be shipped on each reel (there will be no mixing of two groups on each reel). In order to ensure availability, single brightness groups will not be orderable. In a similar manner for colors where wavelength groups are measured and binned, single wavelength groups will be shipped in any one reel. In order to ensure availability, single wavelength groups will not be orderable.

FORWARD VOLTAGE CLASSIFICATION		
GROUP	FORWARD VOLTAGE (V)	
	MIN.	MAX.
V2	2.65	2.75
V3	2.75	2.85
V4	2.85	2.95
V5	2.95	3.05

Note

- Forward voltage is measured with a tolerance of $\pm 0.1\text{ V}$.

TYPE	CC GROUP
VLMW1500, VLMW1503	S1 to S6
VLMW1501	S1 to S4
VLMW1502	S3 to S6

CHROMATICITY COORDINATED GROUPS FOR WHITE SMD LED					
	X		Y		
S1	0.274	0.226	S4	0.294	0.286
	0.274	0.258		0.294	0.319
	0.294	0.286		0.314	0.347
	0.294	0.254		0.314	0.315
S2	0.274	0.258	S5	0.314	0.282
	0.274	0.291		0.314	0.315
	0.294	0.319		0.334	0.343
	0.294	0.286		0.334	0.311
S3	0.294	0.254	S6	0.314	0.315
	0.294	0.286		0.314	0.347
	0.314	0.315		0.334	0.376
	0.314	0.282		0.334	0.343

Note

- Chromaticity coordinate groups are tested at a current pulse duration of 25 ms and a tolerance of ± 0.01 .

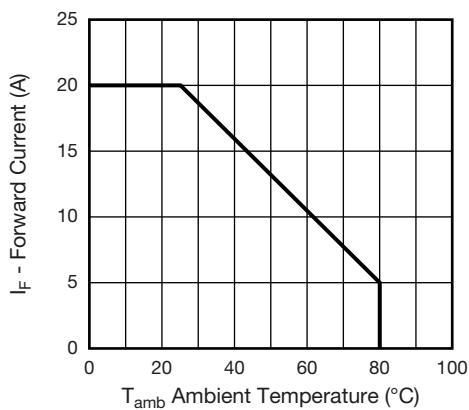
TYPICAL CHARACTERISTICS ($T_{amb} = 25\text{ }^{\circ}\text{C}$, unless otherwise specified)


Fig. 1 - Forward Current vs. Ambient Temperature

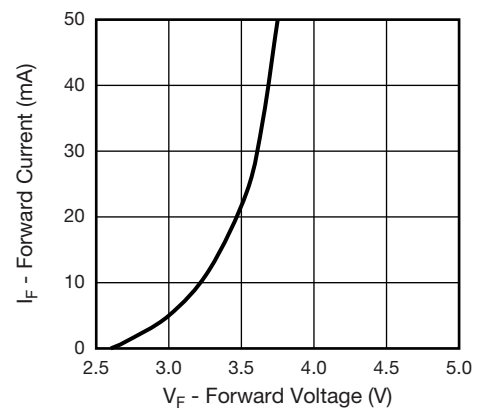


Fig. 3 - Forward Current vs. Forward Voltage

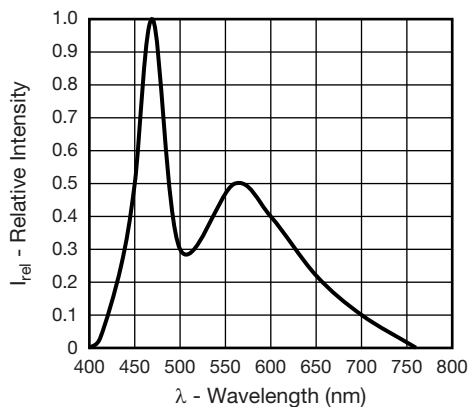


Fig. 2 - Relative Intensity vs. Wavelength

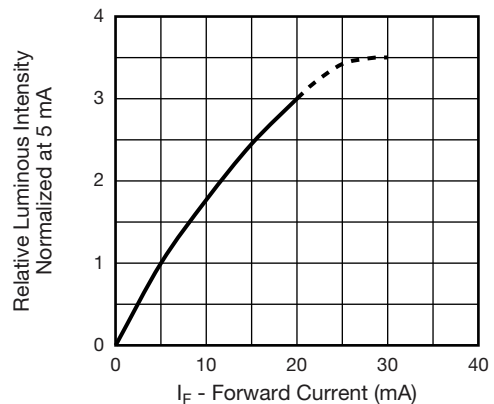


Fig. 4 - Relative Luminous Intensity vs. Forward Current

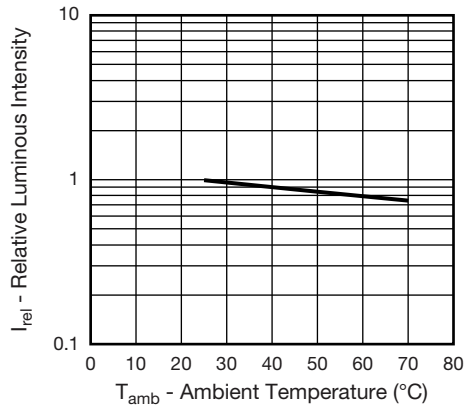


Fig. 5 - Relative Luminous Intensity vs. Ambient Temperature

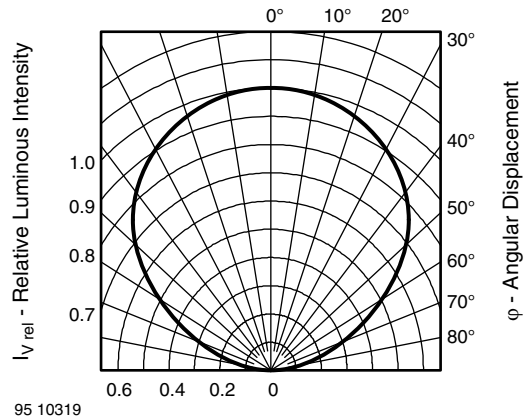


Fig. 7 - Relative Luminous Intensity vs. Angular Displacement

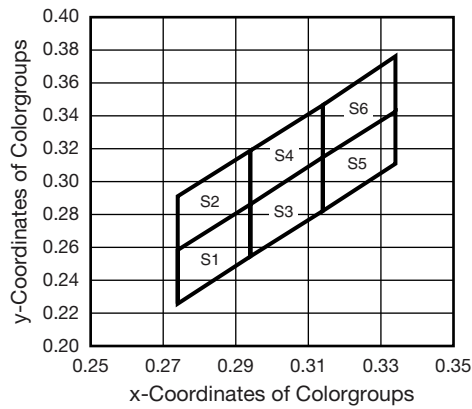
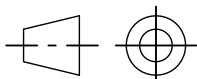
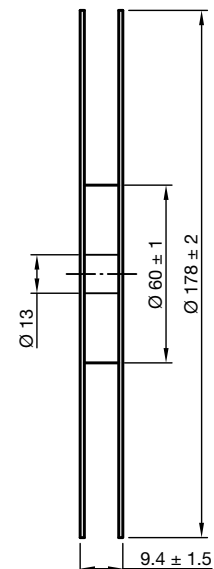
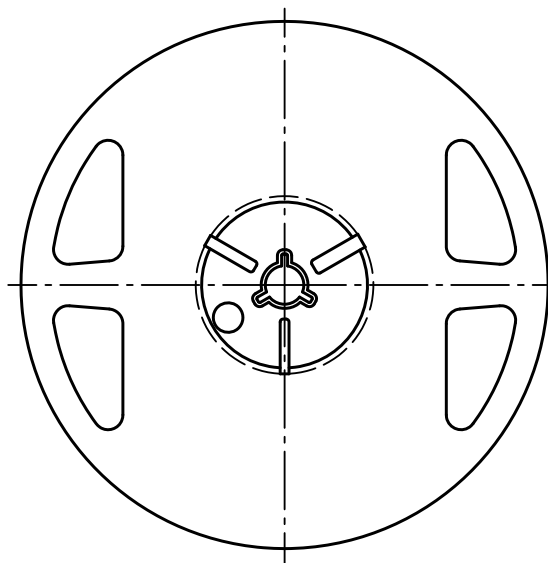


Fig. 6 - Coordinates of Colorgroups

REEL DIMENSIONS in millimeters



technical drawings according to DIN specifications

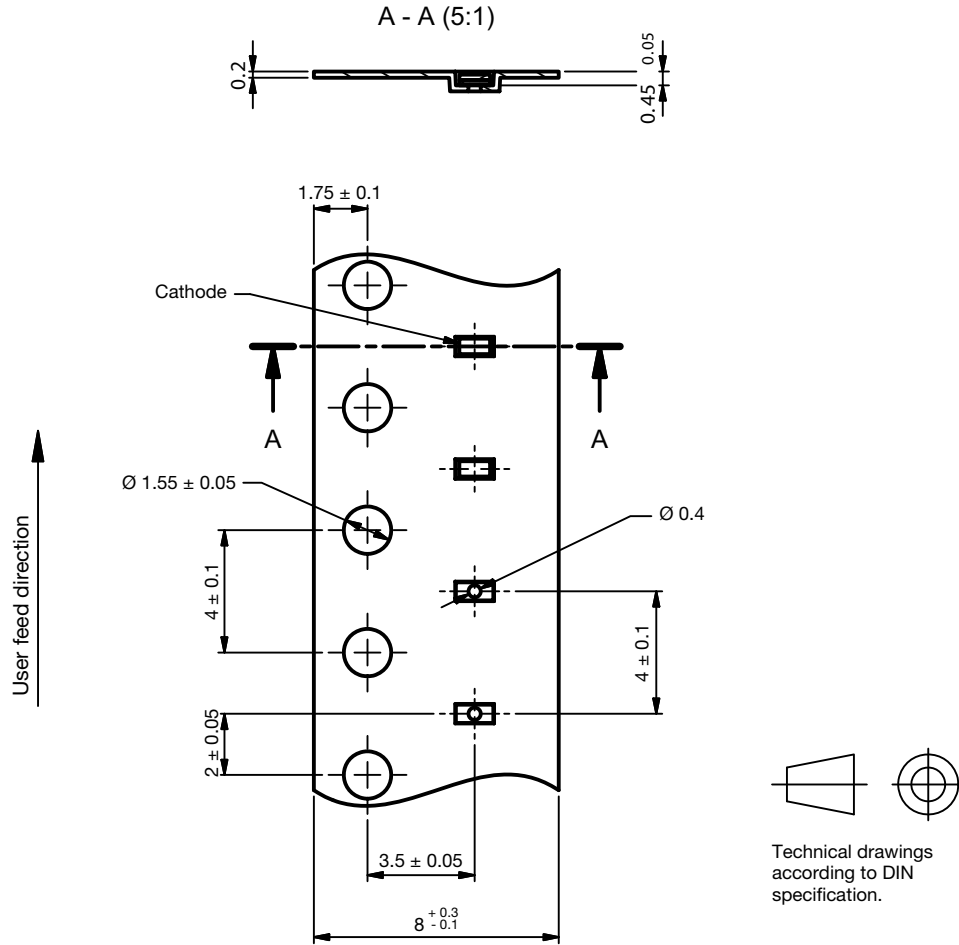


Drawing-No.: 9.800-5122.01-4
Issue: 2; 03.11.11
22611

3000 pieces per reel / 3 reels per box



TAPE DIMENSIONS in millimeters

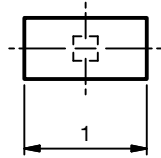
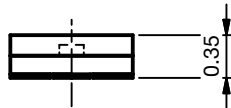
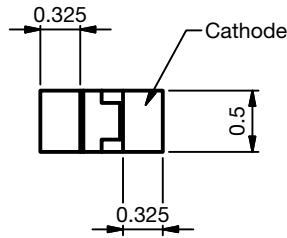


Drawing-No.: 9.700-5388.01-4
Issue: 1; 20.03.12

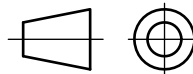
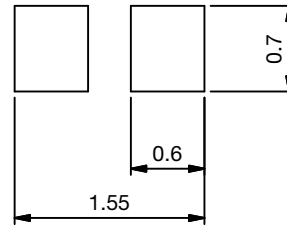
Reels come in quantity of 3000 units
MOQ: 3 reels (9000 pcs)



PACKAGE DIMENSIONS in millimeters



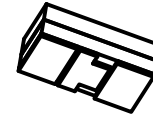
Recommended solder pad footprint



Technical drawings according to DIN specification

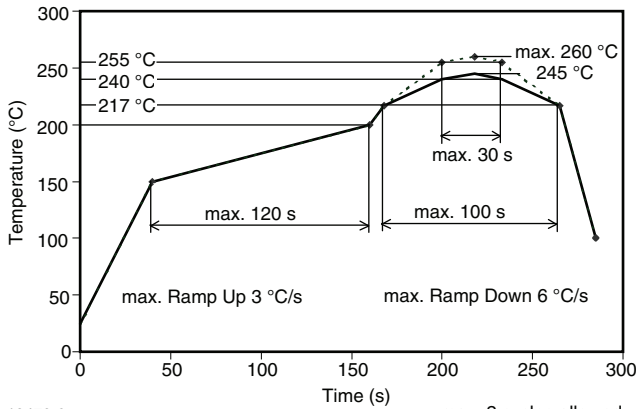
Not indicated tolerances ± 0.1

Drawing-No.: 6.541-5096.01-4
Issue: 2; 10.03.21



SOLDERING PROFILE

IR Reflow Soldering Profile for lead (Pb)-free Soldering
Preconditioning acc. to JEDEC Level 2a

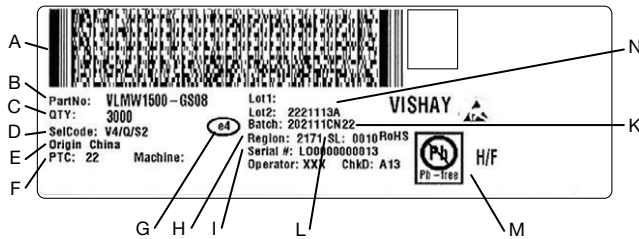


19470-6

max. 2 cycles allowed

Fig. 8 - Vishay Lead (Pb)-free Reflow Soldering Profile (according to J-STD-020C)

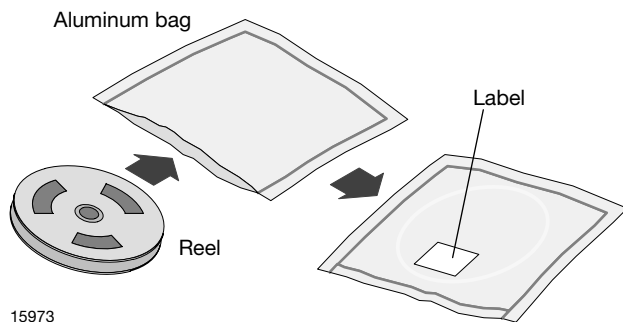
BAR CODE PRODUCT LABEL (example)



- A. 2D barcode
- B. Part No: Vishay part number
- C. QTY: quantity
- D. SelCode: selection bin code
- E. Country of origin
- F. PTC: production plant code
- G. Terminations finishing
- H. Region code
- I. Serial#: serial number
- K. Batch Number: year, week, country code, plant code
- L. SL: storage location
- M. Environmental Symbols: RoHS, lead (Pb)-free, halogen-free
- N. Lot numbers

DRY PACKING

The reel is packed in an anti-humidity bag to protect the devices from absorbing moisture during transportation and storage.



FINAL PACKING

The sealed reel is packed into a cardboard box. A secondary cardboard box is used for shipping purposes.

RECOMMENDED METHOD OF STORAGE

Dry box storage is recommended as soon as the aluminum bag has been opened to prevent moisture absorption. The following conditions should be observed, if dry boxes are not available:

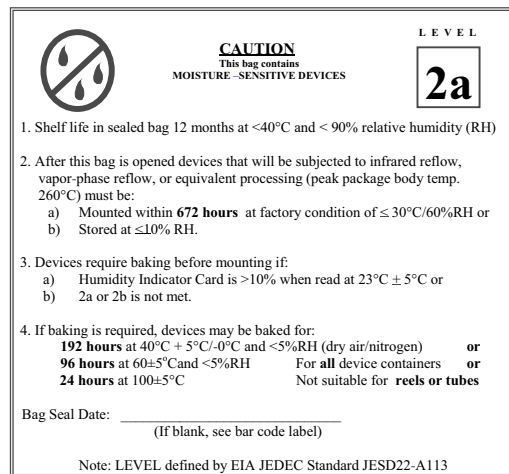
- Storage temperature 10 °C to 30 °C
- Storage humidity ≤ 60 % RH max.

After more than 672 h under these conditions moisture content will be too high for reflow soldering.

In case of moisture absorption, the devices will recover to the former condition by drying under the following condition: 192 h at 40 °C + 5 °C / - 0 °C and < 5 % RH (dry air / nitrogen)

- or
- 96 h at 60 °C + 5 °C and < 5 % RH for all device containers
- or
- 24 h at 100 °C + 5 °C not suitable for reel or tubes.

An EIA JEDEC standard JESD22-A112 level 2a label is included on all dry bags.



Example of JESD22-A112 Level 2a Label

ESD PRECAUTION

Proper storage and handling procedures should be followed to prevent ESD damage to the devices especially when they are removed from the antistatic shielding bag. Electrostatic sensitive devices warning labels are on the packaging.

VISHAY SEMICONDUCTORS STANDARD BAR CODE LABELS

The Vishay Semiconductors standard bar code labels are printed at final packing areas. The labels are on each packing unit and contain Vishay Semiconductors specific data.



Disclaimer

ALL PRODUCT, PRODUCT SPECIFICATIONS AND DATA ARE SUBJECT TO CHANGE WITHOUT NOTICE TO IMPROVE RELIABILITY, FUNCTION OR DESIGN OR OTHERWISE.

Vishay Intertechnology, Inc., its affiliates, agents, and employees, and all persons acting on its or their behalf (collectively, "Vishay"), disclaim any and all liability for any errors, inaccuracies or incompleteness contained in any datasheet or in any other disclosure relating to any product.

Vishay makes no warranty, representation or guarantee regarding the suitability of the products for any particular purpose or the continuing production of any product. To the maximum extent permitted by applicable law, Vishay disclaims (i) any and all liability arising out of the application or use of any product, (ii) any and all liability, including without limitation special, consequential or incidental damages, and (iii) any and all implied warranties, including warranties of fitness for particular purpose, non-infringement and merchantability.

Statements regarding the suitability of products for certain types of applications are based on Vishay's knowledge of typical requirements that are often placed on Vishay products in generic applications. Such statements are not binding statements about the suitability of products for a particular application. It is the customer's responsibility to validate that a particular product with the properties described in the product specification is suitable for use in a particular application. Parameters provided in datasheets and / or specifications may vary in different applications and performance may vary over time. All operating parameters, including typical parameters, must be validated for each customer application by the customer's technical experts. Product specifications do not expand or otherwise modify Vishay's terms and conditions of purchase, including but not limited to the warranty expressed therein.

Hyperlinks included in this datasheet may direct users to third-party websites. These links are provided as a convenience and for informational purposes only. Inclusion of these hyperlinks does not constitute an endorsement or an approval by Vishay of any of the products, services or opinions of the corporation, organization or individual associated with the third-party website. Vishay disclaims any and all liability and bears no responsibility for the accuracy, legality or content of the third-party website or for that of subsequent links.

Except as expressly indicated in writing, Vishay products are not designed for use in medical, life-saving, or life-sustaining applications or for any other application in which the failure of the Vishay product could result in personal injury or death. Customers using or selling Vishay products not expressly indicated for use in such applications do so at their own risk. Please contact authorized Vishay personnel to obtain written terms and conditions regarding products designed for such applications.

No license, express or implied, by estoppel or otherwise, to any intellectual property rights is granted by this document or by any conduct of Vishay. Product names and markings noted herein may be trademarks of their respective owners.

Looking for pricing, stock, or lifecycle information?

Click below to explore more details on WIN SOURCE:

 [View VLMW1500-GS08](#) on WIN SOURCE

 [Vishay](#) Information

Optimize Your Supply Chain with WIN SOURCE Solutions

-  Global Sourcing Solution
-  Obsolete Management
-  Cost Control Management
-  Shortage Management
-  Alternative Solution
-  Excess Inventory Management