



# THE DATASHEET OF CAM-M8Q-0



# CAM-M8

## u-blox M8 Concurrent GNSS Antenna Modules Data Sheet



### Abstract

Technical data sheet describing the CAM-M8 module series, which provides concurrent reception of up to 3 GNSS (GPS, Galileo, GLONASS, BeiDou). CAM-M8 includes an embedded, omni-directional and wideband antenna and provides the option to connect an external antenna as well.

# Document Information

<b>Title</b>	<b>CAM-M8</b>		
<b>Subtitle</b>	Data Sheet		
<b>Document type</b>	Data Sheet		
<b>Document number</b>	UBX-15031574		
<b>Revision and date</b>	R04	28-Jan-2019	
<b>Document status</b>	Production Information		

<b>Product status</b>	<b>Corresponding content status</b>	
<b>In Development / Prototype</b>	Objective Specification	Target values. Revised and supplementary data will be published later.
<b>Engineering Sample</b>	Advance Information	Data based on early testing. Revised and supplementary data will be published later.
<b>Initial Production</b>	Early Production Information	Data from product verification. Revised and supplementary data may be published later.
<b>Mass Production / End of Life</b>	Production Information	Document contains the final product specification.

This document applies to the following products:

<b>Product name</b>	<b>Type number</b>	<b>ROM/FLASH version</b>	<b>PCN reference</b>
CAM-M8Q	CAM-M8Q-0-10	ROM SPG 3.01	UBX-16016365
CAM-M8C	CAM-M8C-0-10	ROM SPG 3.01	UBX-16016365

u-blox or third parties may hold intellectual property rights in the products, names, logos and designs included in this document. Copying, reproduction, modification or disclosure to third parties of this document or any part thereof is only permitted with the express written permission of u-blox.

The information contained herein is provided "as is" and u-blox assumes no liability for its use. No warranty, either express or implied, is given, including but not limited to, with respect to the accuracy, correctness, reliability and fitness for a particular purpose of the information. This document may be revised by u-blox at any time without notice. For the most recent documents, visit [www.u-blox.com](http://www.u-blox.com).

Copyright © u-blox AG.

# Contents

<b>Document Information</b> .....	<b>2</b>
<b>Contents</b> .....	<b>3</b>
<b>1 Functional description</b> .....	<b>5</b>
1.1 Overview .....	5
1.2 Product features .....	6
1.3 GNSS performance .....	6
1.4 Block diagram .....	7
1.5 Supported GNSS constellations .....	8
1.5.1 GPS .....	8
1.5.2 GLONASS .....	8
1.5.3 BeiDou .....	8
1.5.4 Galileo .....	9
1.6 Assisted GNSS (A-GNSS).....	9
1.6.1 AssistNow™ Online.....	9
1.6.2 AssistNow™ Offline.....	9
1.6.3 AssistNow™ Autonomous .....	9
1.7 Augmentation systems .....	10
1.7.1 Satellite-Based Augmentation System (SBAS) .....	10
1.7.2 QZSS .....	10
1.7.3 IMES .....	10
1.7.4 Differential GPS (D-GPS).....	11
1.8 Broadcast navigation data and satellite signal measurements .....	11
1.9 Odometer .....	11
1.10 Geofencing.....	11
1.11 Message Integrity Protection.....	11
1.12 Spoofing detection .....	12
1.13 EXTINT: External interrupt.....	12
1.13.1 Pin control .....	12
1.13.2 Aiding .....	12
1.14 TIMEPULSE .....	12
1.15 Protocols and interfaces .....	13
1.16 Interfaces.....	13
1.16.1 UART .....	13
1.16.2 SPI .....	13
1.16.3 Display Data Channel (DDC) .....	13
1.17 Clock generation.....	14
1.17.1 Oscillators .....	14
1.17.2 Real-Time Clock (RTC) .....	14
1.18 Power management .....	14
1.18.1 DC-DC converter .....	14

1.18.2 Power Mode Setup.....	15
1.19 Antenna.....	16
1.19.1 Embedded antenna .....	16
1.19.2 External GPS/GLONASS antenna connectivity.....	16
1.19.3 Active antenna control (LNA_EN) .....	16
1.19.4 Embedded antenna operation .....	16
<b>2 Pin definition .....</b>	<b>18</b>
2.1 Pin assignment.....	18
2.2 Pin name changes.....	19
<b>3 Configuration management.....</b>	<b>20</b>
3.1 Interface Selection (D_SEL) .....	20
<b>4 Electrical specification .....</b>	<b>21</b>
4.1 Absolute maximum rating.....	21
4.2 Operating conditions.....	21
4.3 Indicative power requirements.....	22
<b>5 Mechanical specifications .....</b>	<b>23</b>
<b>6 Reliability tests and approvals.....</b>	<b>24</b>
6.1 Reliability tests.....	24
6.2 Approvals.....	24
<b>7 Product handling &amp; soldering.....</b>	<b>25</b>
7.1 Packaging .....	25
7.2 Reels .....	25
7.3 Tapes .....	25
7.4 Shipment, storage and handling .....	25
7.4.1 Moisture Sensitivity Levels .....	26
7.4.2 Reflow soldering.....	26
7.4.3 Antenna ageing.....	26
7.4.4 ESD handling precautions .....	26
<b>8 Default messages .....</b>	<b>27</b>
<b>9 Labeling and ordering information .....</b>	<b>28</b>
9.1 Product labeling.....	28
9.2 Explanation of codes .....	28
9.3 Ordering codes.....	28
<b>Appendix .....</b>	<b>29</b>
<b>A Glossary .....</b>	<b>29</b>
<b>Related documents .....</b>	<b>30</b>
<b>Revision history .....</b>	<b>30</b>
<b>Contact.....</b>	<b>31</b>

# 1 Functional description

## 1.1 Overview

The u-blox concurrent CAM-M8 series GNSS antenna modules benefit from the exceptional performance of the u-blox M8 multi-GNSS (GPS/QZSS, GLONASS, GALILEO and BeiDou) engine in an industry proven form factor. The CAM-M8 modules offer high sensitivity and strong signal levels in an ultra-compact form factor.

The CAM-M8 series modules utilize concurrent reception of up to three GNSS systems (GPS/Galileo together with BeiDou or GLONASS), recognize multiple constellations simultaneously, and provide outstanding positioning accuracy in scenarios where urban canyon or weak signals are involved. For even better and faster positioning improvement, the CAM-M8 series supports augmentation of QZSS, GAGAN and IMES together with WAAS, EGNOS, and MSAS. The CAM-M8 series also supports message integrity protection, geofencing, and spoofing detection with configurable interface settings to easily fit to customer applications.

Incorporating the CAM-M8 modules into customer designs is simple and straightforward, thanks to the embedded GNSS chip antenna, a small footprint of 9.6 x 14.0 x 1.95 mm, and sophisticated interference suppression that ensures maximum performance even in GNSS-hostile environments. The low power consumption, and thin design allow end devices to be slimmer and smaller.

Despite the miniature size, the GNSS chip antenna in the CAM-M8 series performs extremely well compared to traditional patch antennas. The omni-directional radiation pattern increases flexibility for device installation. Optionally, CAM-M8 modules can be connected to an external GNSS antenna. The SMD design keeps manufacturing costs to a minimum and the small mass ensures high reliability.

 Because the customer PCB is part of the antenna solution, some PCB layout design rules should be followed in order to maintain optimal performance of the on-board GNSS chip antenna. For more information, see the CAM-M8 Hardware Integration Manual [1].

The CAM-M8 series modules target industrial and consumer applications that require concurrent GPS/Galileo and GLONASS or GPS/Galileo and BeiDou reception. The CAM-M8C is optimized for cost sensitive applications and has the lowest power consumption, while the CAM-M8Q provides best performance. The CAM-M8 series is form-factor compatible to UC530 and UC530M modules, allowing the upgrade of existing designs with minimal effort.

The CAM-M8 series modules use GNSS chips qualified according to AEC-Q100, are manufactured in ISO/TS 16949 certified sites, and fully tested on a system level. Qualification tests are performed as stipulated in the ISO 16750 standard: "Road vehicles – Environmental conditions and testing for electrical and electronic equipment".

## 1.2 Product features

Model	Category	GNSS				Supply	Interfaces	Features						Grade
	Standard Precision GNSS High Precision GNSS Dead Reckoning Timing	GPS/QZSS GLONASS Galileo BeiDou		Number of concurrent GNSS	1.65 V - 3.6 V 2.7 V - 3.6 V	UART USB SPI DDC (I <sup>2</sup> C compliant)	Programmable (flash) Data logging Additional SAW Additional LNA RTC crystal Oscillator Built-in antenna Built-in antenna supply and supervisor Timepulse	Standard Professional Automotive						
<b>CAM-M8Q</b>	•	• • • •	3	•	• • •	• • • T •	1	•						
<b>CAM-M8C</b>	•	• • • •	3	•	• • •	• • ♦ C •	1	•						

♦ = Yes, but with a higher backup current

C = Crystal / T = TCXO

## 1.3 GNSS performance

Parameter	Specification					
Receiver type	72-channel u-blox M8 engine GPS L1C/A, SBAS L1C/A, QZSS L1C/A, QZSS L1 SAIF, GLONASS L1OF, BeiDou B1I, Galileo E1B/C					
Accuracy of time pulse signal	RMS	30 ns				
	99%	60 ns				
Frequency of time pulse signal	0.25 Hz...10 MHz (configurable)					
Operational limits <sup>1</sup>	Dynamics	≤ 4 g				
	Altitude	50,000 m				
	Velocity	500 m/s				
Velocity accuracy <sup>2</sup>	0.05 m/s					
Heading accuracy <sup>2</sup>	0.3 degrees					
<b>GNSS</b>	<b>GPS &amp; GLONASS</b>	<b>GPS</b>	<b>GLONASS</b>	<b>BEIDOU</b>	<b>GALILEO</b>	
Horizontal position accuracy <sup>3</sup>	2.5 m	2.5 m	4 m	3 m	TBC <sup>4</sup>	
Max navigation update rate <sup>5</sup>	10 Hz	18 Hz	18 Hz	18 Hz	18 Hz	
<b>CAM-M8Q</b>						
Time-To-First-Fix <sup>6</sup>	Cold start	26 s	29 s	30 s	34 s	45 s
	Hot start	1 s	1 s	1 s	1 s	1 s
	Aided starts <sup>7</sup>	2 s	2 s	2 s	3 s	7 s
Tracking & Navigation	-167 dBm	-166 dBm	-166 dBm	-160 dBm	-159 dBm	

<sup>1</sup> Assuming Airborne < 4 g platform

<sup>2</sup> 50% @ 30 m/s

<sup>3</sup> CEP, 50%, 24 hours static, -130 dBm, > 6 SVs

<sup>4</sup> To be confirmed when Galileo reaches full operational capability

<sup>5</sup> Rates with SBAS and QZSS enabled for > 98% fix report rate under typical conditions

<sup>6</sup> All satellites at -130 dBm, except Galileo at -127 dBm

<sup>7</sup> Dependent on aiding data connection speed and latency

Parameter	Specification					
Sensitivity <sup>8</sup>	Reacquisition	-160 dBm	-160 dBm	-156 dBm	-157 dBm	-153 dBm
	Cold start	-148 dBm	-148 dBm	-145 dBm	-143 dBm	-138 dBm
	Hot start	-157 dBm	-157 dBm	-156 dBm	-155 dBm	-151 dBm
<b>CAM-M8C</b>						
Time-To-First-Fix <sup>6</sup>	Cold start	26 s	30 s	31 s	39 s	57 s
	Hot start	1 s	1 s	1 s	1 s	1 s
	Aided starts <sup>7</sup>	3 s	3 s	3 s	7 s	7 s
Sensitivity <sup>8</sup>	Tracking & Navigation	-164 dBm	-164 dBm	-163 dBm	-160 dBm	-154 dBm
	Reacquisition	-160 dBm	-159 dBm	-156 dBm	-155 dBm	-152 dBm
	Cold start	-148 dBm	-147 dBm	-145 dBm	-143 dBm	-133 dBm
	Hot start	-157 dBm	-156 dBm	-155 dBm	-155 dBm	-151 dBm

Table 1: CAM-M8Q/C performance in different GNSS modes (Default is concurrent reception of GPS and GLONASS, incl. QZSS, SBAS)

## 1.4 Block diagram

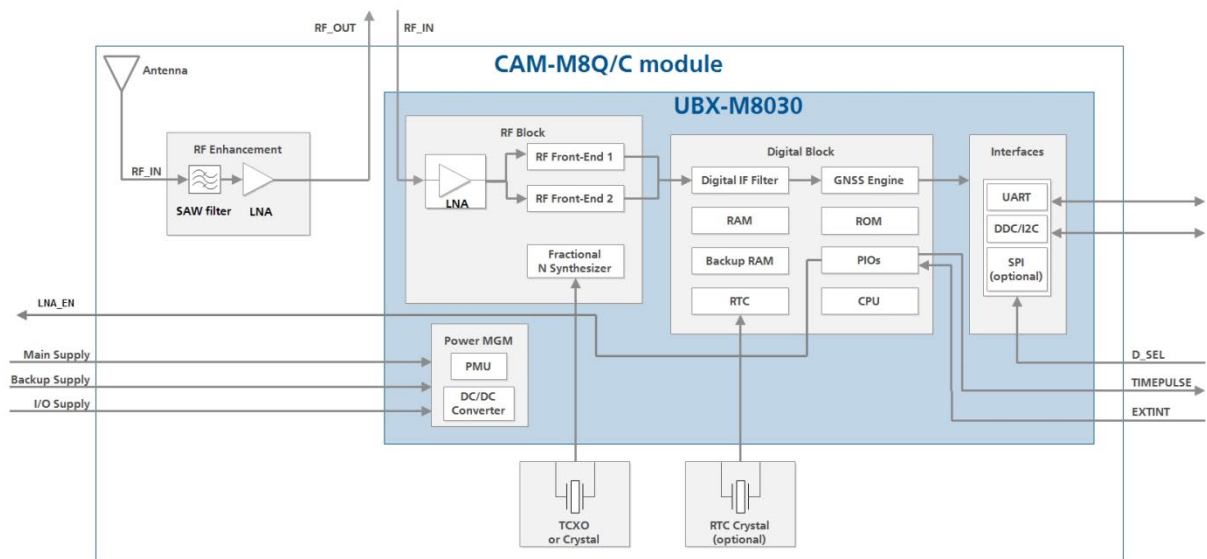

Figure 1: CAM-M8Q/C block diagram



<sup>8</sup> Demonstrated with a good external LNA

## 1.5 Supported GNSS constellations

The CAM-M8 series GNSS modules are concurrent GNSS receivers which can receive and track multiple GNSS systems: GPS, Galileo, GLONASS and BeiDou. Owing to the dual-frequency RF front-end architecture, either GLONASS or BeiDou can be processed concurrently with GPS and Galileo signals providing reception of three GNSS systems. By default the M8 receivers are configured for concurrent GPS and GLONASS, including SBAS and QZSS reception. If power consumption is a key factor, then the receiver should be configured for a single GNSS operation using GPS, Galileo, GLONASS or BeiDou and disabling QZSS and SBAS. The module can be configured to receive any single GNSS constellation or within the set of permissible combinations shown below.

GPS	Galileo	GLONASS	BeiDou
•	•	–	–
•	•	•	–
•	•	–	•
•	–	•	–
•	–	–	•
–	•	•	–
–	•	–	•
–	–	•	•

**Table 2: Permissible GNSS combinations (• = enabled)**

-  The augmentation systems: SBAS and QZSS can be enabled only if GPS operation is configured.
-  Galileo is not enabled as the default configuration.

### 1.5.1 GPS

The u-blox CAM-M8 series positioning modules are designed to receive and track the L1C/A signals provided at 1575.42 MHz by the Global Positioning System (GPS).

### 1.5.2 GLONASS

The CAM-M8 modules can receive and process GLONASS concurrently with GPS or BeiDou. The Russian GLONASS satellite system is an alternative system to the US-based Global Positioning System (GPS). u-blox CAM-M8 positioning modules are designed to receive and track the L1OF signals GLONASS provided at  $1602 \text{ MHz} + k \cdot 562.5 \text{ kHz}$ , where  $k$  is the satellite's frequency channel number ( $k = -7, \dots, 5, 6$ ). The ability to receive and track GLONASS L1OF satellite signals allows design of GLONASS receivers where required by regulations.



In order to take advantage of GPS and GLONASS, dedicated hardware preparation must be taken during the design-in phase, see the CAM-M8 Hardware Integration Manual [1] for u-blox design recommendations.

### 1.5.3 BeiDou

The CAM-M8 series positioning modules can receive and process the B1I signals broadcast at 1561.098 MHz from the BeiDou Navigation Satellite System. The ability to receive and track BeiDou signals in conjunction with another constellation results in higher coverage, improved reliability and better accuracy. Currently, BeiDou is not fully operational globally and provides Chinese regional coverage only. Global coverage is scheduled for 2020.

## 1.5.4 Galileo

The CAM-M8 series positioning modules can receive and track the E1-B/C signals centered on the GPS L1 frequency band. GPS and Galileo signals can be processed concurrently together with either BeiDou or GLONASS signals, enhancing coverage, reliability and accuracy. The SAR return link message (RLM) parameters for both short and long versions are decoded by the receiver and made available to users via UBX proprietary messages.

-  Galileo has been implemented according to ICD release 1.2 (November 2015) and verified with live signals from the Galileo in-orbit validation campaign. Since the Galileo satellite system has not yet reached Initial (IOC) nor Full Operational Capability (FOC), changes to the Galileo signal specification (OS SIS ICD) remain theoretically possible. u-blox therefore recommends to use Flash based modules in designs utilizing Galileo signals in order to allow for a FW update in the unlikely event of a change to the Galileo signal specification (OS SIS ICD).
-  Galileo reception is by default disabled, but can be enabled by sending a configuration message (UBX-CFG-GNSS) to the receiver. See the u-blox 8 / u-blox M8 Receiver Description Including Protocol Specification [2] for more information.

## 1.6 Assisted GNSS (A-GNSS)

Supply of aiding information, such as ephemeris, almanac, rough last position and time, will reduce the time to first fix significantly and improve the acquisition sensitivity. The u-blox CAM-M8 series receivers support the u-blox AssistNow Online and AssistNow Offline A-GNSS services, support AssistNow Autonomous, and are OMA SUPL compliant.

### 1.6.1 AssistNow™ Online

With AssistNow Online, an internet-connected GNSS device downloads assistance data from u-blox's AssistNow Online Service at system start-up. AssistNow Online is network operator independent and globally available.

u-blox only sends ephemeris data for those satellites currently visible to the device requesting the data, thus minimizing the amount of data transferred.

Supply of aiding information, such as ephemeris, almanac, rough last position and time, will reduce the time to first fix significantly and improve the acquisition sensitivity.

-  The AssistNow Online service provides data for GPS, GLONASS, BeiDou, Galileo and QZSS

### 1.6.2 AssistNow™ Offline

With AssistNow Offline, users download u-blox's long-term orbit data from the Internet at their convenience. The orbit data must be stored in the memory of application processor. Therefore, the service requires no connectivity at system start-up and enables a position fix within seconds, even when no network is available. AssistNow Offline data offers augmentation for up to 35 days.

-  AssistNow Offline service provides data for GPS and GLONASS only, BeiDou and Galileo are not currently supported

### 1.6.3 AssistNow™ Autonomous

AssistNow Autonomous provides aiding information without the need for a host or external network connection. Based on previous broadcast satellite ephemeris data downloaded to and stored by the

GNSS receiver, AssistNow Autonomous automatically generates accurate predictions of satellite orbital data (“AssistNow Autonomous data”) that is usable for future GNSS position fixes. The concept capitalizes on the periodic nature of GNSS satellites; by capturing strategic ephemeris data at specific times of the day.

u-blox’s AssistNow Autonomous benefits are:

- Faster fix in situations where GNSS satellite signals are weak
- No connectivity required
- Compatible with AssistNow Online (can work stand-alone, or in tandem with the AssistNow Online service)
- No integration effort, calculations are done in the background, transparent to the user.

 The u-blox ROM-based CAM-M8Q/C receiver can use AssistNow Autonomous to calculate GPS only orbit predictions for 3 days.

 For more details on A-GNSS see the u-blox 8 / u-blox M8 Receiver Description Including Protocol Specification [2].

## 1.7 Augmentation systems

### 1.7.1 Satellite-Based Augmentation System (SBAS)

The u-blox CAM-M8 series positioning modules support SBAS. These systems supplement GPS data with additional regional or wide area GPS augmentation data. The system broadcasts augmentation data via satellite and this information can be used by GNSS receivers to improve the resulting precision. SBAS satellites can be used as additional satellites for ranging (navigation), further enhancing precision and availability. The following SBAS types are supported with CAM-M8 modules: GAGAN, WAAS, EGNOS and MSAS.

 For more details, see the u-blox 8 / u-blox M8 Receiver Description Including Protocol Specification [2].

### 1.7.2 QZSS

The Quasi-Zenith Satellite System (QZSS) is a regional navigation satellite system that transmits additional GPS L1 C/A signals for the Pacific region covering Japan and Australia. CAM-M8Q/C positioning modules are able to receive and track these signals concurrently with GPS signals, resulting in better availability especially under challenging signal conditions, e.g. in urban canyons. The L1- SAIF signal provided by QZSS can be enabled for reception via a GNSS configuration message.

### 1.7.3 IMES

The Japanese Indoor Messaging System (IMES) system is used for indoor position reporting using low-power transmitters which broadcast a GPS-like signal. CAM-M8Q/C modules can be configured to receive and demodulate the signal to provide an in-door location estimate.

 This service is authorized and available only in Japan.



 IMES reception is disabled by default

### 1.7.4 Differential GPS (D-GPS)

The u-blox CAM-M8 series receivers support differential GPS data according to RTCM 10402.3 [4]. The use of differential GPS data improves GPS position accuracy. The RTCM implementation supports the following RTCM 2.3 messages:

Message Type	Description
1	Differential GPS Corrections
2	Delta Differential GPS Corrections
3	GPS Reference Station Parameters
9	GPS Partial Correction Set

Table 3: Supported RTCM 2.3 messages

-  RTCM corrections cannot be used together with SBAS.
-  For more details, see the u-blox 8 / u-blox M8 Receiver Description Including Protocol Specification [2].

## 1.8 Broadcast navigation data and satellite signal measurements

The CAM-M8 series modules can output all the GNSS broadcast data upon reception from tracked satellites. This includes all the supported GNSS signals plus the augmentation services SBAS, QZSS and IMES. The receiver also makes available the tracked satellite signal information, i.e. raw code phase and Doppler measurements in a form aligned to the ETSI mobile cellular location services protocol (RRLP) [6]. For more details, see the u-blox 8 / u-blox M8 Receiver Description Including Protocol Specification [2].

### 1.9 Odometer

The odometer provides information on travelled ground distance (in meters) using solely the position and Doppler-based velocity of the navigation solution. For each computed travelled distance since the last odometer reset, the odometer estimates a 1-sigma accuracy value. The total cumulative ground distance is maintained and saved in the BBR memory.

-  The odometer feature is disabled by default. For more details, see the u-blox 8 / u-blox M8 Receiver Description Including Protocol Specification [2].

### 1.10 Geofencing

The CAM-M8 series modules support up to four circular Geofencing areas defined on the Earth's surface using a 2D model. Geofencing is active when at least one Geo-fence is defined, the current status can be found by polling the receiver. A GPIO pin can be nominated to indicate status to e.g. wake up a host on activation.

### 1.11 Message Integrity Protection

The CAM-M8 modules provide a function to detect third party interference with the UBX message stream sent from receiver to host. The security mechanism "signs" nominated messages via a subsequent UBX message. This message signature is then compared with one generated by the host to determine if the message data has been altered. The signature algorithm seed can use one fixed

secret ID key set by eFuse in production and a dynamic ID key set by the host, enabling users to detect “man-in-the-middle” style attacks.

## 1.12 Spoofing detection

Spoofing is a process whereby a malicious third party tries to control the reported position via a “fake” GNSS broadcast signal. This may result in the form of reporting incorrect position, velocity or time. To combat against this, CAM-M8 series modules include spoofing detection measures to alert the host when signals appear to be suspicious. The receiver combines a number of checks on the received signals looking for inconsistencies across several parameters.

 This feature does not guarantee to detect all spoofing attacks.

## 1.13 EXTINT: External interrupt

**EXTINT** is an external interrupt pin with fixed input voltage thresholds with respect to **VCC\_IO**. It can be used for Control of the receiver or for Aiding.

For more information about how to implement and configure these features, see the u-blox 8 / u-blox M8 Receiver Description Including Protocol Specification [2] and the CAM-M8 Hardware Integration Manual [1].

### 1.13.1 Pin control

The pin control feature allows overriding the automatic active/inactive cycle of Power Save Mode. The state of the receiver can be controlled through the **EXTINT** pin.

The receiver can also be forced OFF using **EXTINT** when Power Save Mode is not active.

### 1.13.2 Aiding

The **EXTINT** pin can be used to supply time or frequency aiding data to the receiver.

For time aiding, hardware time synchronization can be achieved by connecting an accurate time pulse to the **EXTINT** pin.

Frequency aiding can be implemented by connecting a periodic rectangular signal with a frequency up to 500 kHz and arbitrary duty cycle (low/high phase duration must not be shorter than 50 ns) to the **EXTINT** pin. Provide the applied frequency value to the receiver using UBX messages.

## 1.14 TIMEPULSE

A configurable time pulse signal is available with CAM-M8 series modules.

The **TIMEPULSE** output generates pulse trains synchronized with GPS or UTC time grid with intervals configurable over a wide frequency range. Thus it may be used as a low frequency time synchronization pulse or as a high frequency reference signal.

By default the time pulse signal is configured to 1 pulse per second. For more information, see the u-blox 8 / u-blox M8 Receiver Description Including Protocol Specification [2].

## 1.15 Protocols and interfaces

Protocol	Type
NMEA	Input/output, ASCII, 0183, version 4.0 (Configurable to V 2.1, V 2.3 or V4.1)
UBX	Input/output, binary, u-blox proprietary
RTCM	Input, message 1, 2, 3, 9

**Table 4: Available Protocols**

All protocols are available on UART, DDC (I<sup>2</sup>C compliant) and SPI. For specification of the various protocols, see the u-blox 8 / u-blox M8 Receiver Description Including Protocol Specification [2].

## 1.16 Interfaces

A number of interfaces are provided for data communication. The embedded firmware uses these interfaces according to their respective protocol specifications.

### 1.16.1 UART

The CAM-M8 series modules support 1 UART interfaces, which can be used for communication to a host. It supports configurable baud rates. For supported baud rates, see the u-blox 8 / u-blox M8 Receiver Description Including Protocol Specification [2].

-  Designs must allow access to the UART and the **SAFEBOOT\_N** function pin for future service, updates and reconfiguration.

### 1.16.2 SPI

The SPI interface is designed to allow communication to a host CPU. The interface can be operated in slave mode only. The maximum transfer rate using SPI is 125 kB/s and the maximum SPI clock frequency is 5.5 MHz.

-  SPI is not available in the default configuration, because its pins are shared with the UART and DDC interfaces. The SPI interface can be enabled by connecting **D\_SEL** (pin 20) to ground (see section 3.1).

### 1.16.3 Display Data Channel (DDC)

An I<sup>2</sup>C compliant DDC interface is available for communication with an external host CPU or u-blox cellular modules. The interface can be operated in slave mode only. The DDC protocol and electrical interface are fully compatible with the Fast-Mode of the I<sup>2</sup>C industry standard. Since the maximum SCL clock frequency is 400 kHz, the maximum transfer rate is 400 kb/s.

-  The maximum bit rate is 400 kb/s. The interface stretches the clock when slowed down while serving interrupts, so real bit rates may be slightly lower.

## 1.17 Clock generation

### 1.17.1 Oscillators

The CAM-M8Q concurrent GNSS module uses a TCXO oscillator. The TCXO option allows accelerated weak signal acquisition, enabling faster start and reacquisition times.

The CAM-M8C concurrent GNSS module uses a crystal-based oscillator. This makes the CAM-M8C a more cost efficient solution.

Oscillators used on CAM-M8 series modules are carefully selected and screened for stability and against frequency perturbations across the full operating range (-40 °C to +85 °C).

The careful selection and qualification of critical parts, such as GNSS oscillators, has resulted in u-blox modules being the most reliable positioning modules in the industry, particularly in challenging conditions

### 1.17.2 Real-Time Clock (RTC)

In the CAM-M8Q the RTC is driven by a 32 kHz oscillator, which makes use of an external RTC crystal. If the main supply voltage fails and a battery is connected to **V\_BCKP**, parts of the receiver switch off, but the RTC still runs providing a timing reference for the receiver. This operating mode is called Hardware Backup Mode, which enables all relevant data to be saved in the backup RAM to allow a hot or warm start later.

The CAM-M8C has no integrated RTC crystal. The CAM-M8C can operate in single crystal mode, where the 26 MHz crystal oscillator can be used to provide frequency reference to the RTC without using an additional RTC crystal in Hardware Backup Mode. This makes the CAM-M8C a more cost efficient solution at the expense of a higher backup current.

The current time is maintained in the RTC and ephemeris and other last known data is kept in the backup RAM. In A-GNSS based systems, the RTC is not required when coarse or fine time information is available from the network.

 More information, see the CAM-M8 Hardware Integration Manual [1].

## 1.18 Power management

The u-blox M8 technology offers a power optimized architecture with built-in autonomous power saving functions to minimize power consumption at any given time. Furthermore, the receiver can be used in two operating modes: Continuous mode for best performance or Power Save Mode for optimized power consumption respectively.

### 1.18.1 DC-DC converter

The CAM-M8 module integrates a DC-DC converter, allowing reduced power consumption especially when using a main supply voltage above 2.5 V.

 For more information, see the CAM-M8 Hardware Integration Manual [1].

## 1.18.2 Power Mode Setup

u-blox M8 modules can be configured to run in either continuous or a choice of Power Save mode configurations. A template of power mode settings can be used to easily select typical power mode setups to cover the majority of users' requirements.

For specific power saving applications the user has the option to fully configure via the power save mode configuration. For more information, see section [1.18.2.2](#).

The u-blox M8 modules' power mode setup offers a choice of continuous operation and preset Power Save Mode Configurations.

- Continuous (default) mode for best GNSS performance vs power consumption
- Continuous with no compromise in power consumption
- A 1 Hz cyclic tracking mode for aggressive power reduction
- Choice of 2 or 4 Hz <sup>9</sup> cyclic tracking modes for typical wearable applications
- ON/OFF interval mode

### 1.18.2.1 Continuous Mode

Continuous Mode uses the acquisition engine at full performance resulting in the shortest possible TTFF and the highest sensitivity. It searches for all possible satellites until the almanac is completely downloaded. The receiver then switches to the tracking engine to lower power consumption.

Thus, a lower tracking current consumption level will be achieved when:

- A valid GNSS position is obtained
- The entire almanac has been downloaded
- The ephemeris for each satellite in view is valid

### 1.18.2.2 Power Save Mode

For specific power saving applications outside the typical preset power mode setups, users can configure a tailored Power Save Mode.

Power Save Mode provides two dedicated methods, ON/OFF and Cyclic tracking, that reduce average current consumption in different ways to match the needs of the specific application. These operations can be set by using a specific UBX message.

 For more information about power management strategies, see the u-blox 8 / u-blox M8 Receiver Description Including Protocol Specification [2].

---

<sup>9</sup> Single GNSS constellation configuration only

## 1.19 Antenna

The CAM-M8 concurrent GNSS modules are designed with integrated GNSS chip antenna. Optionally, the CAM-M8 series modules can be connected to an external GNSS antenna.

-  Because the customer PCB is used as a part of antenna, some important PCB layout design rules should be followed in order to maintain good performance of the on-board GNSS chip antenna. For more information, see the CAM-M8 Hardware Integration Manual [1].

### 1.19.1 Embedded antenna

The CAM-M8 series modules have an embedded GNSS antenna and the signal is further filtered and amplified by internal Low Noise Amplifier (LNA), which is available at the **RF\_OUT** output. The antenna signal **RF\_OUT** shall be connected externally to **RF\_IN** Antenna Input signal via a short trace between pads. For more information, see the CAM-M8 Hardware Integration Manual [1].

### 1.19.2 External GPS/GLONASS antenna connectivity

The customer may use an external active GNSS antenna connected via an external RF-switch. It is suggested that the active antenna has a net gain including cable loss in the range from +10 dB to +30 dB. Specified sensitivity is measured with an external low noise ( $NF \leq 1\text{dB}$ ,  $G \geq 15\text{dB}$ ) amplifier. The antenna shall provide simultaneous reception of both GPS 1575 MHz and GLONASS bands 1598 to 1606 MHz.

-  External passive antenna is not recommended. For more information concerning external antenna option, see the CAM-M8 Hardware Integration Manual [1].

### 1.19.3 Active antenna control (LNA\_EN)

The **LNA\_EN** Pin can be used to turn on and off an external LNA or an active antenna. This reduces power consumption in Power Save Mode (Backup mode).

-  When **LNA\_EN** Pin is used externally, an external pull down resistor should be connected at **LNA\_EN** signal. For more information, see the CAM-M8 Hardware Integration Manual [1].

### 1.19.4 Embedded antenna operation

The embedded GNSS chip antenna provides optimal radiation efficiency 80% typ. with 80x40 mm ground plane. The GNSS chip antenna provides linear polarization with peak gain 1.1 dBi and radiation pattern optimized for portable devices. The chip antenna is insensitive to surroundings and has high tolerance against frequency shifts. [Figure 2](#) shows the typical free space radiation patterns of the embedded GNSS chip antenna at 1575 GHz. However, on small ground plane widths, the antenna gain and radiation efficiency is reduced.

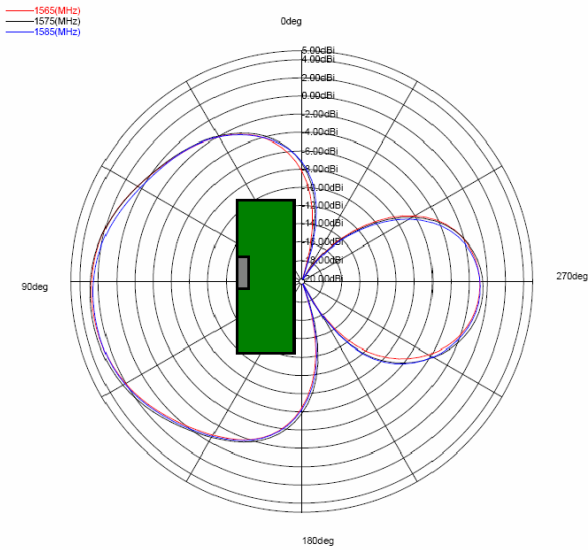
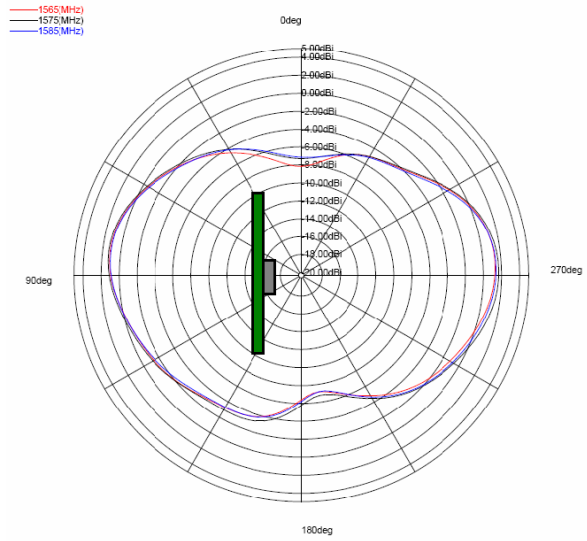
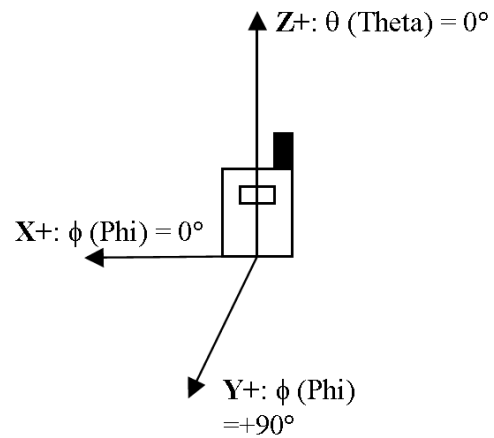
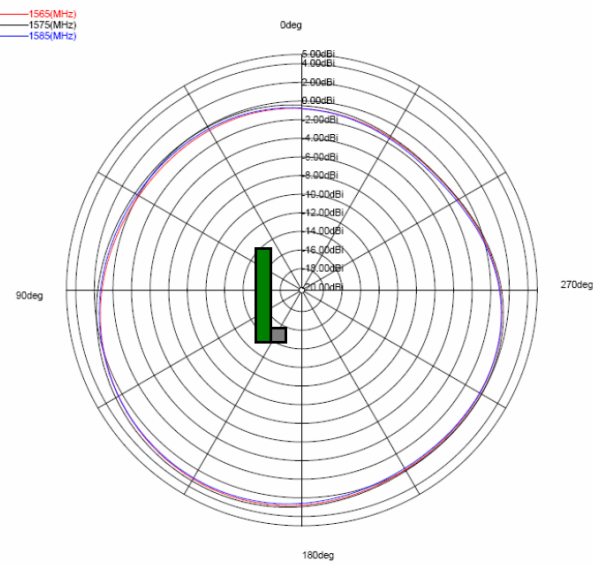
**XZ-PLANE**

**ZY-PLANE**

**XY-PLANE**

**Figure 2: 1.575 GHz typical free space radiation patterns**

## 2 Pin definition

### 2.1 Pin assignment

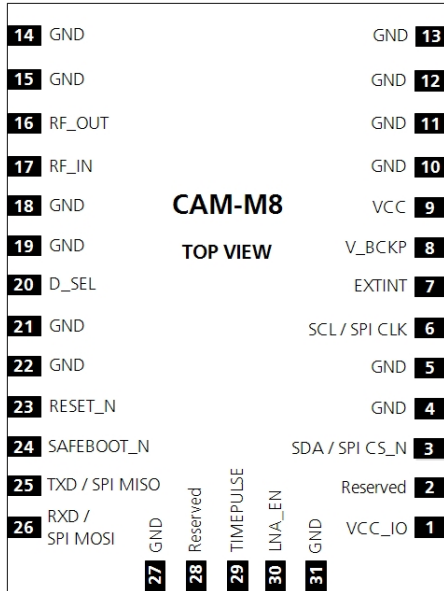



Figure 3: Pin assignment of CAM-M8Q/C

No	Name	I/O	Description
1	VCC_IO		IO Supply Voltage
2	Reserved		Reserved
3	SDA / SPI CS_N	I/O	DDC Data if D_SEL = 1 (or open) SPI Chip Select if D_SEL = 0
4	GND		Ground
5	GND		Ground
6	SCL / SPI CLK	I/O	DDC Clock if D_SEL = 1 (or open) SPI Clock if D_SEL = 0
7	EXTINT		External Interrupt Pin
8	V_BCKP		Backup voltage supply
9	VCC		Supply voltage
10	GND		Ground
11	GND		Ground
12	GND		Ground
13	GND		Ground
14	GND		Ground
15	GND		Ground
16	RF_OUT		Embedded Antenna Output (50 ohm)
17	RF_IN		GPS/GNSS signal input
18	GND		Ground
19	GND		Ground
20	D_SEL		Interface select

No	Name	I/O	Description
21	GND		Ground
22	GND		Ground
23	RESET_N		RESET_N
24	SAFEBOOT_N		SAFEBOOT_N (for future service, updates and reconfiguration, leave OPEN)
25	TXD / SPI MISO	O	Serial Port if D_SEL = 1 (or open) SPI MISO if D_SEL = 0
26	RXD / SPI MOSI	I	Serial Port if D_SEL = 1 (or open) SPI MOSI if D_SEL = 0
27	GND		Ground
28	Reserved		Reserved
29	TIMEPULSE	O	Time pulse (1 PPS)
30	LNA_EN		Antenna control
31	GND		Ground

**Table 5: Pin out for CAM-M8Q/C**

 Pins designated as “Reserved” should not be used. For more information about pinouts, see the CAM-M8 Hardware Integration Manual [1].

## 2.2 Pin name changes

Selected pin names have been updated to agree with a common naming convention across u-blox modules. The pins have not changed their operation and are the same physical hardware but with updated names. The table below lists the pins that have changed name along with their old and new names.

No	Previous Name	New name
30	ANT_ON	LNA_EN
16	ANT	RF_OUT
20	DSEL	D_SEL
3	SDA SPI CS_N	SDA / SPI CS_N
6	SCL SPI CLK	SCL / SPI CLK
25	TXD SPI MISO	TXD / SPI MISO
26	RXD SPI MOSI	RXD / SPI MOSI

## 3 Configuration management

Configuration settings can be modified with UBX configuration messages. The modified settings remain effective until power-down or reset. If these settings have been stored in battery-backup RAM, then the modified configuration will be retained, as long as the backup battery supply is not interrupted.

 For more information about configuration management, see the u-blox 8 / u-blox M8 Receiver Description Including Protocol Specification [2].

### 3.1 Interface Selection (D\_SEL)

At startup, pin 20 (**D\_SEL**) determines which data interfaces are used for communication. If **D\_SEL** is set high or left open, UART and DDC become available. If **D\_SEL** is set low, i.e. connected to ground, the CAM-M8Q/C modules can communicate to a host via SPI.

PIN #	D_SEL = "1" (left open)	D_SEL = "0" (connected to GND)
25	TXD	SPI MISO
26	RXD	SPI MOSI
6	SCL	SPI CLK
3	SDA	SPI CS_N

**Table 6: Data interface selection by D\_SEL**

## 4 Electrical specification

The limiting values given are in accordance with the Absolute Maximum Rating System (IEC 134). Stress above one or more of the limiting values may cause permanent damage to the device. These are stress ratings only, and operation of the device at these or at any other conditions above those given in the Characteristics sections of the specification is not implied. Exposure to these limits for extended periods may affect device reliability.

Where application information is given, it is advisory only and does not form part of the specification. For more information, see the CAM-M8 Hardware Integration Manual [1].

### 4.1 Absolute maximum rating

Parameter	Symbol	Condition	Min	Max	Units
Power supply voltage	VCC, VCC_IO		-0.5	3.6	V
Backup battery voltage	V_BCKP		-0.5	3.6	V
Input pin voltage	Vidig	Input voltage on Configurable Inputs, RESET_N if VCC_IO < 3.1V	-0.5	VCC_IO+0.5	V
		Input voltage on Configurable Inputs, RESET_N if VCC_IO > 3.1V	-0.5	3.6	V
DC current through any digital I/O pin (except supplies)	I <sub>pin</sub>			10	mA
Input power at RF_IN	Pr <sub>fin</sub>	source impedance = 50 Ω, continuous wave		15	dBm
Storage temperature	T <sub>stg</sub>		-40	85	°C

**Table 7: Absolute maximum ratings of CAM-M8Q/C**

Stressing the device beyond the “Absolute Maximum Ratings” may cause permanent damage. These are stress ratings only. The product is not protected against overvoltage or reversed voltages. If necessary, voltage spikes exceeding the power supply voltage specification, given in table above, must be limited to values within the specified boundaries by using appropriate protection diodes.

### 4.2 Operating conditions

All specifications are at an ambient temperature of +25 °C. Extreme operating temperatures can significantly impact specification values. Applications operating near the temperature limits should be tested to ensure the specification.

Parameter	Symbol	Module	Min	Typ	Max	Units	Condition
Power supply voltage	VCC, VCC_IO	CAM-M8C	1.65	3.0	3.6	V	
		CAM-M8Q	2.7	3.0	3.6	V	
Backup battery voltage	V_BCKP	All	1.4		3.6	V	
Backup battery current	I_BCKP	CAM-M8Q		15		μA	V_BCKP = 3.0 V, VCC = 0 V
		CAM-M8C		100		μA	V_BCKP = 3.0 V, VCC = 0 V

Parameter	Symbol	Module	Min	Typ	Max	Units	Condition
SW backup current	I_SWBCKP	CAM-M8Q		30		μA	VCC = 3.0 V
		CAM-M8C		105		μA	VCC = 3.0 V
Input pin voltage range <sup>10</sup>	Vin	All	-0.5		VCC_IO+0.5	V	
Digital IO Pin Low level input voltage	Vil	All	0		0.2*VCC_IO	V	
Digital IO Pin High level input voltage	Vih	All	0.7*VCC_IO		VCC_IO+0.5	V	
Digital IO Pin Low level output voltage	Vol	All			0.4	V	Iol = 4 mA
Digital IO Pin High level output voltage	Voh	All	VCC_IO - 0.4			V	Ioh = 4 mA
Pull-up resistor for RESET_N (Internal)	Rpu	All		11		kΩ	
Receiver Chain Noise Figure <sup>11</sup>	NFtot	All		3.5		dB	
Operating temperature	Topr	All	-40		85	°C	

**Table 8: Operating conditions**

Operation beyond the specified operating conditions can affect device reliability.

### 4.3 Indicative power requirements

[Table 9](#) lists examples of the total system supply current for a possible application.

The values in [Table 9](#) are provided for customer information only, as an example of typical power requirements. Values are characterized on samples; actual power requirements can vary depending on FW version used, external circuitry, the number of SVs tracked, signal strength, type of start as well as time, duration and conditions of test.

Parameter	Symbol	Module	Typ		Max	Units
			GPS / QZSS / SBAS & GLONASS	GPS / QZSS / SBAS		
Max. supply current <sup>12</sup>	lccp	All			71	mA
Average supply current <sup>13, 14</sup>	Icc Acquisition <sup>15</sup>	CAM-M8Q	30		26	mA
		CAM-M8C	32		26	mA
	Icc Tracking (Continuous mode)	CAM-M8Q	28		23	mA
		CAM-M8C	28		23	mA
	Icc Tracking (Power Save mode / 1 Hz)	CAM-M8Q	10.9		10.4	mA
	CAM-M8C	10.1		9.6	mA	

**Table 9: Indicative power requirements at 3.0 V**

For more information about power requirements, see the CAM-M8 Hardware Integration Manual [1].

For more information on how to noticeably reduce current consumption, see the Power Management Application Note [5]).

<sup>10</sup> If VCC or VCC\_IO is 0V there should not be any voltage applied to any I/O (Including RESET\_N)

<sup>11</sup> Only valid for the GPS band

<sup>12</sup> Use this figure to dimension maximum current capability of power supply. Measurement of this parameter with 1 Hz bandwidth.

<sup>13</sup> Use this figure to determine required battery capacity.

<sup>14</sup> Simulated GNSS constellation using power level of -130 dBm. VCC = 3.0 V

<sup>15</sup> Average current from start-up until the first fix.

## 5 Mechanical specifications

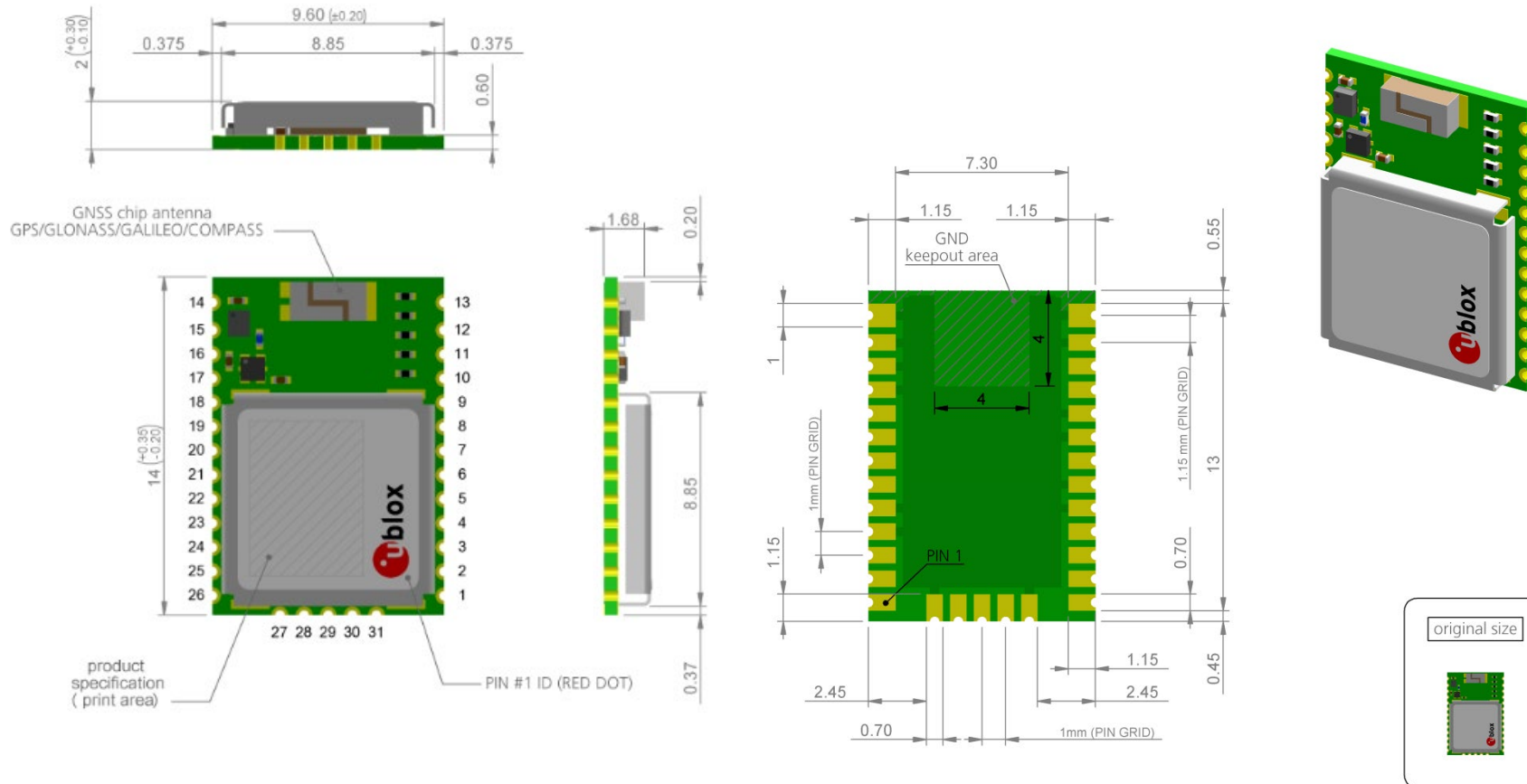



Figure 4: Dimensions (units: mm)



For information about the paste mask and footprint, see the CAM-M8 Hardware Integration Manual [1].

## 6 Reliability tests and approvals

### 6.1 Reliability tests

 The CAM-M8Q/C concurrent GNSS antenna modules are based on AEC-Q100 qualified GNSS chips.

Tests for product qualifications are according to ISO 16750 "Road vehicles – Environmental conditions and testing for electrical and electronic equipment", and appropriate standards.

### 6.2 Approvals



The CAM-M8Q and CAM-M8C modules comply with the Directives 2011/65/EU and 2015/863/EU of the European Parliament and the Council on the Restriction of Use of certain Hazardous Substances (RoHS).

## 7 Product handling & soldering

### 7.1 Packaging

The CAM-M8Q/C modules are delivered as hermetically sealed, reeled tapes in order to enable efficient production, production lot set-up and tear-down. For more information, see the u-blox Package Information Guide [3].

### 7.2 Reels

The CAM-M8Q/C GPS modules are deliverable in quantities of 500 pieces on a reel. The CAM-M8Q/C modules are shipped on reel type B, as specified in the u-blox Package Information Guide [3].

### 7.3 Tapes

Figure 5 shows the position and orientation of CAM-M8 series modules as they are delivered on tape. The dimensions of the tape are specified in Figure 6.

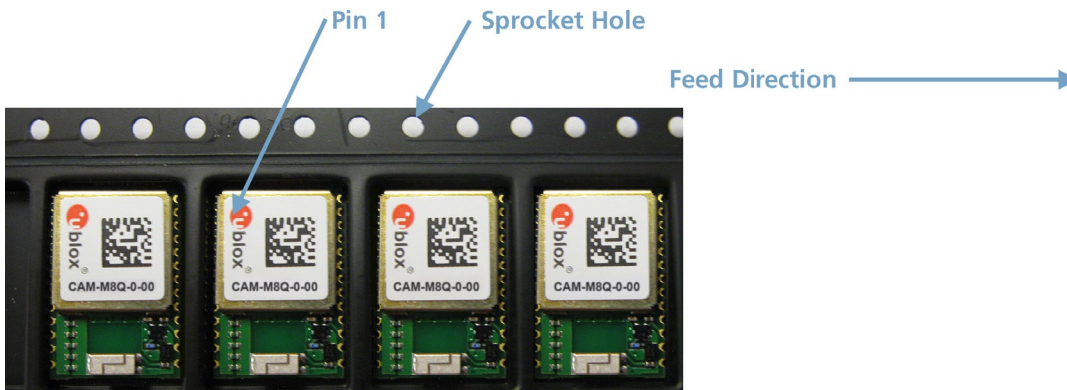

Figure 5: Tape and module orientation

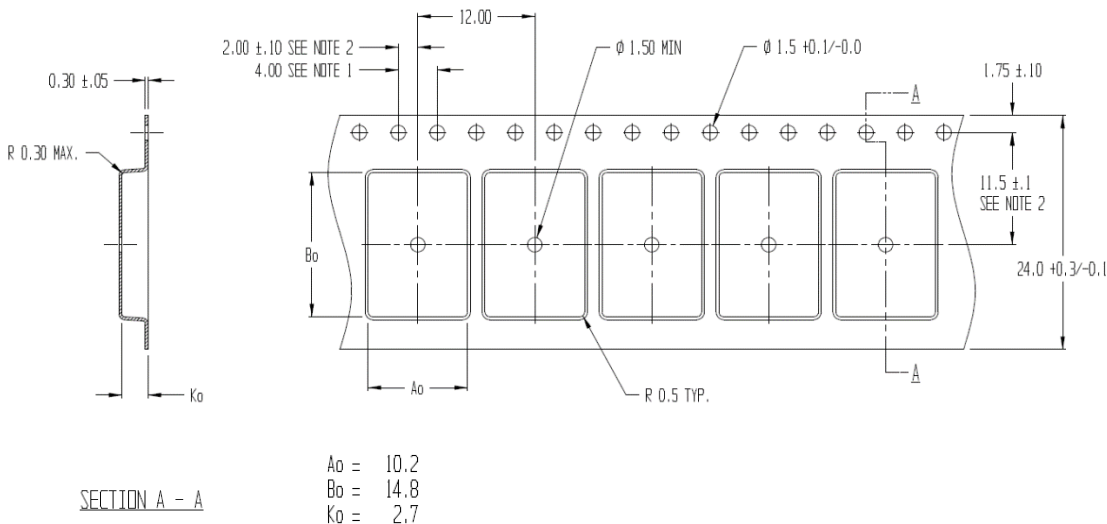

Figure 6: Dimensions and orientation for CAM-M8Q/C modules on tape

### 7.4 Shipment, storage and handling

For important information about shipment, storage and handling, see the u-blox Package Information Guide [3].

### 7.4.1 Moisture Sensitivity Levels

The Moisture Sensitivity Level (MSL) relates to the packaging and handling precautions required. CAM-M8Q/C modules are rated at MSL level 4.

For MSL standard see IPC/JEDEC J-STD-020. Download available at [www.jedec.org](http://www.jedec.org).

For more information regarding MSL, see the u-blox Package Information Guide [3].

### 7.4.2 Reflow soldering

Reflow profiles are to be selected according to u-blox recommendations (see the CAM-M8 Hardware Integration Manual [1]).

### 7.4.3 Antenna ageing

Antenna electrode metallization is unprotected silver and will tarnish during storage due to sulfuric compounds present in the atmosphere. Elevated temperature and humidity will accelerate this process. Human skin contact, wool etc. will also cause tarnishing. This has no effect on the electrical performance of the antenna. u-blox accepts no warranty claims for tarnished products due to this normal and to be expected process.

### 7.4.4 ESD handling precautions

CAM-M8Q/C modules are Electrostatic Sensitive Devices (ESD). Observe handling precautions! Failure to observe these precautions can result in severe damage to the GNSS receiver!

GNSS receivers are Electrostatic Sensitive Devices (ESD) and require special precautions when handling. Exercise care when handling patch antennas, due to the risk of electrostatic charges. In addition to standard ESD safety practices, take the following measures into account whenever handling the receiver:

- Unless there is a galvanic coupling between the local GND (i.e. the work table) and the PCB GND, then the first point of contact when handling the PCB must always be between the local GND and PCB GND.
- Before mounting an antenna patch, connect ground of the device
- When handling the RF pin, do not come into contact with any charged capacitors and be careful when contacting materials that can develop charges (e.g. patch antenna ~10 pF, coax cable ~50-80 pF/m, soldering iron, ...)
- To prevent electrostatic discharge through the RF input, do not touch any exposed antenna area. If there is any risk that such exposed antenna area is touched in non ESD protected work area, implement proper ESD protection measures in the design.
- When soldering RF connectors and patch antennas to the receiver's RF pin, make sure to use an ESD safe soldering iron (tip).

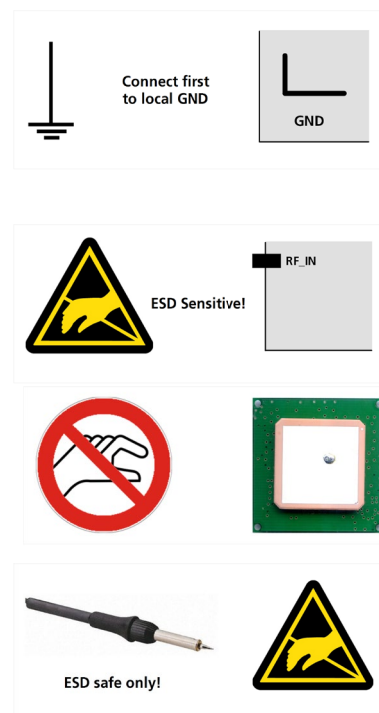

## 8 Default messages

Interface	Settings
UART Output	9600 Baud, 8 bits, no parity bit, 1 stop bit Configured to transmit both NMEA and UBX protocols, but no UBX messages and only the following NMEA have been activated at start-up: <b>GGA, GLL, GSA, GSV, RMC, VTG, TXT</b>
UART Input	9600 Baud, 8 bits, no parity bit, 1 stop bit, Autobauding disabled Automatically accepts following protocols without need of explicit configuration: UBX, NMEA, RTCM The GPS receiver supports interleaved UBX and NMEA messages.
DDC	Fully compatible with the I <sup>2</sup> C industry standard, available for communication with an external host CPU or u-blox cellular modules, operated in slave mode only. NMEA and UBX are enabled as input messages, only NMEA as output messages Maximum bit rate 400 kb/s.
TIMEPULSE (1 Hz Nav)	1 pulse per second, synchronized at rising edge, pulse length 100 ms

**Table 10: Default messages**

 Refer to the u-blox 8 / u-blox M8 Receiver Description Including Protocol Specification [2] for information about further settings.

## 9 Labeling and ordering information

### 9.1 Product labeling

The labeling of u-blox CAM-M8Q/C GNSS antenna modules include important product information. The location of the product type number is shown in [Figure 7](#).

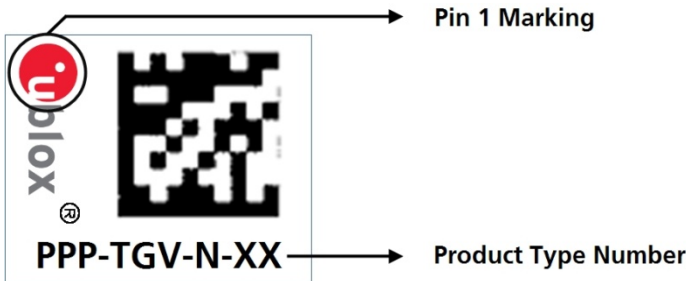

Figure 7: Location of product type number on u-blox CAM-M8Q/C module label

### 9.2 Explanation of codes

Three different product code formats are used. The **Product Name** is used in documentation such as this data sheet and identifies all u-blox products, independent of packaging and quality grade. The **Ordering Code** includes options and quality, while the **Type Number** includes the hardware and firmware versions. [Table 11](#) below details these three different formats:

Format	Structure
Product Name	PPP-TGV
Ordering Code	PPP-TGV-N
Type Number	PPP-TGV-N-XX

Table 11: Product code formats

The parts of the product code are explained in [Table 12](#).

Code	Meaning	Example
PPP	Product Family	CAM
TG	Technology & Generation	M8 = u-blox M8
V	Variant	Function set (A-Z), T = Timing, R = DR, etc.
N	Option / Quality Grade	Describes standardized functional element or quality grade 0 = Default variant, A = Automotive
XX	Product Detail	Describes product details or options such as hardware and software revision, cable length, etc.

Table 12: Part identification code

### 9.3 Ordering codes

Ordering No.	Product
CAM-M8Q-0	u-blox M8 Concurrent GNSS LCC Antenna Module, TCXO, SAW, LNA, ROM, 9.6 x 14.0 mm, 500 pcs/reel
CAM-M8C-0	u-blox M8 Concurrent GNSS LCC Antenna Module, Crystal, SAW, LNA, ROM, 9.6 x 14.0 mm, 500 pcs/reel

Table 13: Product ordering codes for professional grade module

Product changes affecting form, fit or function are documented by u-blox. For a list of Product Change Notifications (PCNs), see our website.

# Appendix

## A Glossary

Abbreviation	Definition
AEC	Automotive Electronics Council
BBR	Battery Backed RAM
DDC	Display Data Channel
EGNOS	European Geostationary Navigation Overlay Service
ESD	Electrostatic Sensitive Device*
FOC	Full Operational Capability
GAGAN	GPS Aided GEO Augmented Navigation
GLONASS	GLObal Navigation Satellite System (Russian)
GNSS	Global Navigation Satellite System
GPIO	General Purpose Input/Output
GPS	Global Positioning System
IMES	Indoor MESSaging System
I2C	Inter-Integrated Circuit
IEC	International Electrotechnical Commission
ISO	International Organization for Standardization
LCC	Leadless Chip Carrier
LCS	LoCation Services (protocol)
LNA	Low Noise Amplifier
MSAS	MTSAT Satellite Augmentation System
MSL	Moisture Sensitivity Level
NMEA	National Marine Electronics Association
PPP	Point-to-Point Protocol* / Precise Point Positioning*
PCB	Printed Circuit Board
PCN	Product Change Notification
PPS	Pulse Per Second
QZSS	Quasi-Zenith Satellite System
RLM	Return Link Message
RRLP	Radio Resource LCS Protocol
RTC	Real Time Clock
RTCM	Radio Technical Commission for Maritime Services
SAW	Surface Acoustic Wave
SBAS	Satellite-Based Augmentation System
SCL	Serial Clock
SMD	Solder Mask Defined
SUPL	Secure User Plane Location
TCXO	Temperature-Compensated Crystal Oscillator
TTF	Time-To-First-Fix
UART	Universal Asynchronous Receiver/Transmitter
UTC	Coordinated Universal Time
WAAS	Wide Area Augmentation System

**Table 14: Explanation of the abbreviations and terms used**

## Related documents

- [1] CAM-M8 (FW3) Hardware Integration Manual, Doc. No. [UBX-15030063](#)
- [2] u-blox 8 / u-blox M8 Receiver Description Including Protocol Specification (Public version), Doc. No. [UBX-13003221](#)
- [3] u-blox Package Information Guide, Doc. No. [UBX-14001652](#)
- [4] RTCM 10402.3 Recommended Standards for Differential GNSS, Ver. 2.3, RTCM Aug. 20, 2001
- [5] Power Management Application Note, Doc. No. [UBX-13005162](#)
- [6] Radio Resource LCS Protocol (RRLP), (3GPP TS 44.031 version 11.0.0 Release 11)

 For regular updates to u-blox documentation and to receive product change notifications, register on our homepage ([www.u-blox.com](http://www.u-blox.com)).

## Revision history

Revision	Date	Name	Comments
R01	15-Sep-2016	ghun	Advance Information
R02	31-Oct-2016	ghun	Production Information
R03	12-Feb-2018	rmak	Updated Sections 1.6.3 and 4.1, and legal statement in cover page and added Documentation feedback e-mail address in contacts page.
R04	28-Jan-2019	mbab, rmak	Reformat, updated Section 6.2 (RoHS statement).

# Contact

For complete contact information, visit us at [www.u-blox.com](http://www.u-blox.com).

## u-blox Offices

### North, Central and South America

#### u-blox America, Inc.

Phone: +1 703 483 3180  
E-mail: [info\\_us@u-blox.com](mailto:info_us@u-blox.com)

#### Regional Office West Coast:

Phone: +1 408 573 3640  
E-mail: [info\\_us@u-blox.com](mailto:info_us@u-blox.com)

#### Technical Support:

Phone: +1 703 483 3185  
E-mail: [support@u-blox.com](mailto:support@u-blox.com)

### Headquarters

#### Europe, Middle East, Africa

#### u-blox AG

Phone: +41 44 722 74 44  
E-mail: [info@u-blox.com](mailto:info@u-blox.com)  
Support: [support@u-blox.com](mailto:support@u-blox.com)

### Asia, Australia, Pacific

#### u-blox Singapore Pte. Ltd.

Phone: +65 6734 3811  
E-mail: [info\\_ap@u-blox.com](mailto:info_ap@u-blox.com)  
Support: [support\\_ap@u-blox.com](mailto:support_ap@u-blox.com)

#### Regional Office Australia:

Phone: +61 2 8448 2016  
E-mail: [info\\_anz@u-blox.com](mailto:info_anz@u-blox.com)  
Support: [support\\_ap@u-blox.com](mailto:support_ap@u-blox.com)

#### Regional Office China (Beijing):

Phone: +86 10 68 133 545  
E-mail: [info\\_cn@u-blox.com](mailto:info_cn@u-blox.com)  
Support: [support\\_cn@u-blox.com](mailto:support_cn@u-blox.com)

#### Regional Office China (Chongqing):

Phone: +86 23 6815 1588  
E-mail: [info\\_cn@u-blox.com](mailto:info_cn@u-blox.com)  
Support: [support\\_cn@u-blox.com](mailto:support_cn@u-blox.com)

#### Regional Office China (Shanghai):

Phone: +86 21 6090 4832  
E-mail: [info\\_cn@u-blox.com](mailto:info_cn@u-blox.com)  
Support: [support\\_cn@u-blox.com](mailto:support_cn@u-blox.com)

#### Regional Office China (Shenzhen):

Phone: +86 755 8627 1083  
E-mail: [info\\_cn@u-blox.com](mailto:info_cn@u-blox.com)  
Support: [support\\_cn@u-blox.com](mailto:support_cn@u-blox.com)

#### Regional Office India:

Phone: +91 80 405 092 00  
E-mail: [info\\_in@u-blox.com](mailto:info_in@u-blox.com)  
Support: [support\\_in@u-blox.com](mailto:support_in@u-blox.com)

#### Regional Office Japan (Osaka):

Phone: +81 6 6941 3660  
E-mail: [info\\_jp@u-blox.com](mailto:info_jp@u-blox.com)  
Support: [support\\_jp@u-blox.com](mailto:support_jp@u-blox.com)

#### Regional Office Japan (Tokyo):

Phone: +81 3 5775 3850  
E-mail: [info\\_jp@u-blox.com](mailto:info_jp@u-blox.com)  
Support: [support\\_jp@u-blox.com](mailto:support_jp@u-blox.com)

#### Regional Office Korea:



Phone: +82 2 542 0861  
E-mail: [info\\_kr@u-blox.com](mailto:info_kr@u-blox.com)  
Support: [support\\_kr@u-blox.com](mailto:support_kr@u-blox.com)

#### Regional Office Taiwan:



Phone: +886 2 2657 1090  
E-mail: [info\\_tw@u-blox.com](mailto:info_tw@u-blox.com)  
Support: [support\\_tw@u-blox.com](mailto:support_tw@u-blox.com)

## Looking for pricing, stock, or lifecycle information?

Click below to explore more details on WIN SOURCE:

-  [View CAM-M8Q-0 on WIN SOURCE](#)
-  [U-blox Information](#)

## Optimize Your Supply Chain with WIN SOURCE Solutions

-  Global Sourcing Solution
-  Obsolete Management
-  Cost Control Management
-  Shortage Management
-  Alternative Solution
-  Excess Inventory Management