



**THE DATASHEET OF  
HMC951BLP4E**



## GaAs MMIC I/Q DOWNCONVERTER 5.6 - 8.6 GHz

### Typical Applications

The HMC951BLP4E is ideal for:

- Point-to-Point and Point-to-Multi-Point Radios
- Military Radar, EW & ELINT
- Satellite Communications

### Features

- Conversion Gain: 13 dB
- Image Rejection: 24 dBc
- Input Third-Order Intercept (IP3): 1 dBm
- Input Power for 1 dB Compression (P1dB): -5 dBm
- Noise Figure: 2 dB
- LO to RF Isolation: 48 dB
- Single 3.5 V Supply Operation
- 24 Lead 4 mm x 4 mm SMT Package

### Functional Diagram

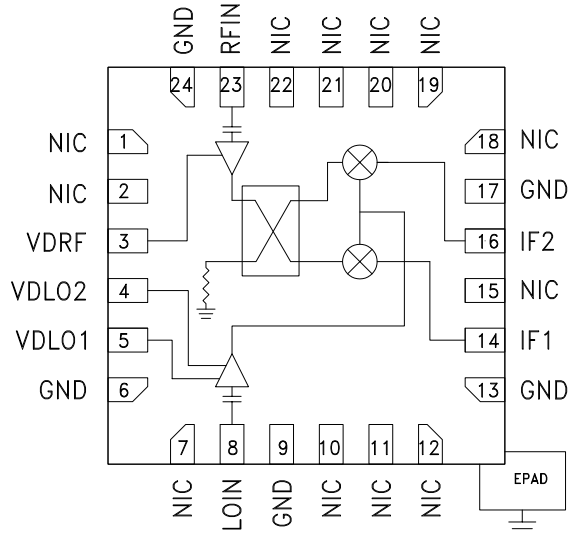

### General Description

The HMC951BLP4E is a compact GaAs MMIC I/Q downconverter in a leadless RoHS compliant SMT package. This device provides a small signal conversion gain of 13 dB with a noise figure of 2 dB and 24 dBc of image rejection across the frequency band. The HMC951BLP4E utilizes an low noise amplifier (LNA) followed by an image reject mixer which is driven by an LO buffer amplifier. The image reject mixer eliminates the need for a filter following the LNA and removes thermal noise at the image frequency. I and Q mixer outputs are provided and an external 90° hybrid is needed to select the required sideband. The HMC951BLP4E is a much smaller alternative to hybrid style image reject mixer downconverter assemblies and is compatible with surface mount manufacturing techniques.

### Electrical Specifications, $T_A = +25^\circ\text{C}$

$IF = 1000\text{ MHz}$ ,  $LO = +2\text{ dBm}$ ,  $VDRF = VDLO1 = VDLO2 = 3.5\text{ V}$ ,  $LSB$  [1]

Parameter	Min.	Typ.	Max.	Units
RF Frequency Range	5.6		8.6	GHz
LO Frequency Range	4.5		12.1	GHz
IF Frequency Range	DC		3.5	GHz
Conversion Gain	10	13		dB
Noise Figure		2	2.5	dB
Image Rejection	13	24		dBc
Input Power for 1 dB Compression (P1dB)		-5		dBm
LO to RF Isolation	40	48		dB
LO to IF Isolation	10	15		dB
Input Third-Order Intercept (IP3)	-3	1		dBm
Amplitude Balance [1]		0.5		dB
Phase Balance [1]		±3		Degree
Total Supply Current (IDRF + IDLO)		160	200	mA

[1] Unless otherwise noted, all data taken as IRM with external 90° Hybrid at the IF ports.

**GaAs MMIC I/Q DOWNCONVERTER**  
**5.6 - 8.6 GHz**

*Data Taken as IRM Downconverter with External IF 90° Hybrid, IF = 1000 MHz*

**Conversion Gain vs. Frequency at Various Temperatures, LO Drive = +2 dBm, LSB**

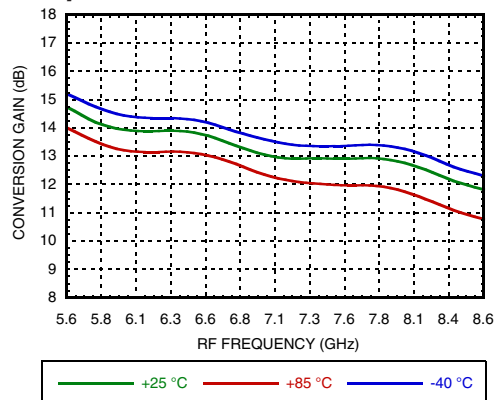

**Conversion Gain vs. Frequency at Various LO Drives, LSB**

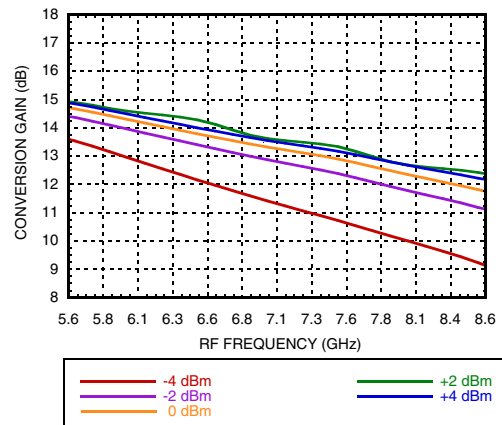

**Image Rejection vs. Frequency at Various Temperatures, LO Drive = +2 dBm, LSB**

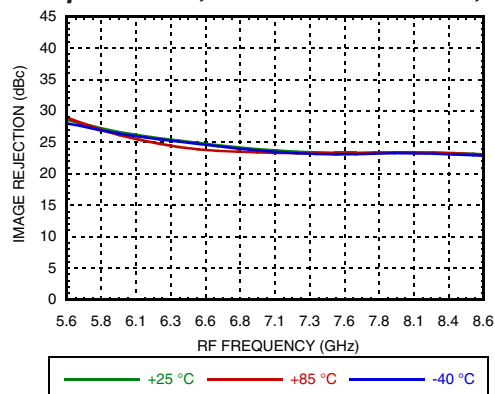

**RF Return Loss vs. Frequency at Various Temperatures, LO Drive = +2 dBm**

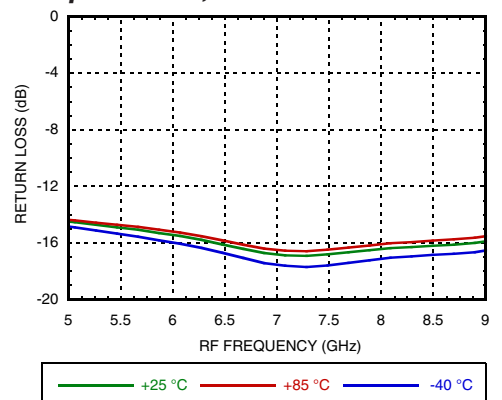

**LO Return Loss vs. Frequency at Various Temperatures, LO Drive = +2 dBm**

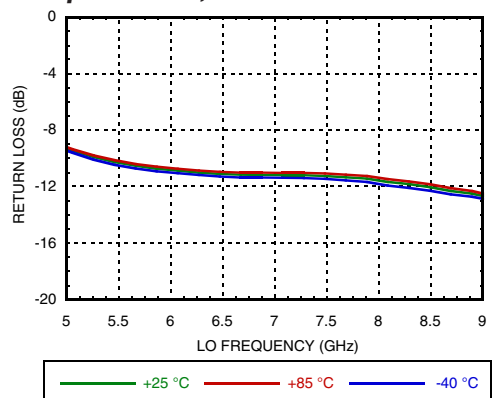

**IF Return Loss vs. IF Frequency, LO Drive = +2 dBm**

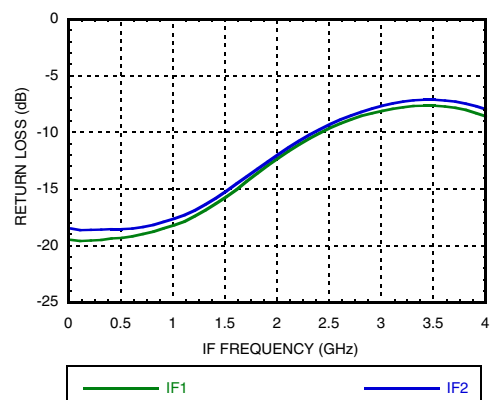

**GaAs MMIC I/Q DOWNCONVERTER  
5.6 - 8.6 GHz**

*Data Taken as IRM Downconverter with External IF 90° Hybrid, IF = 1000 MHz*

**Isolations vs. Frequency**

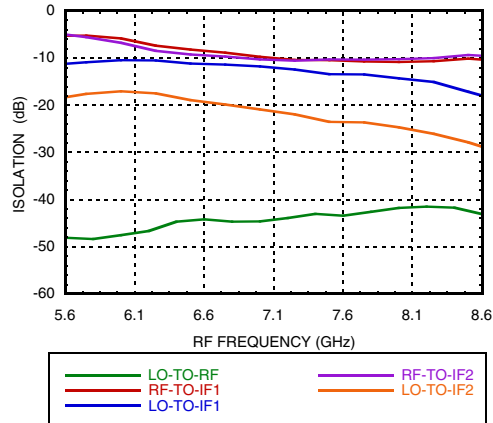

**Input P1dB vs. Frequency at Various Temperatures, LO Drive = +2 dBm, LSB**

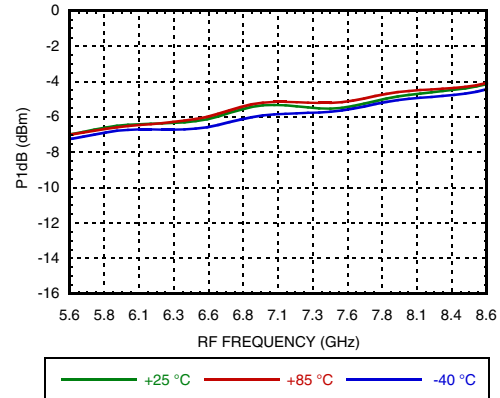

**Input IP3 vs. Frequency at Various Temperatures, LO Drive = +2 dBm, LSB**

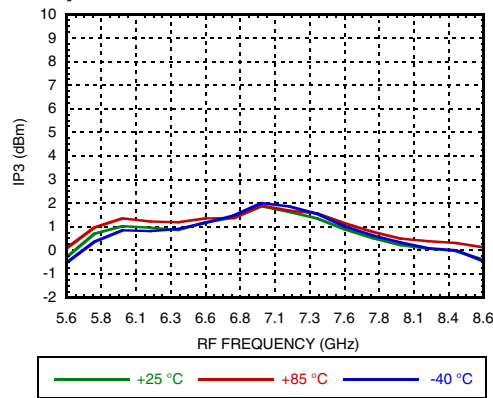

**Input IP3 vs. Frequency at Various LO Drives, LSB**

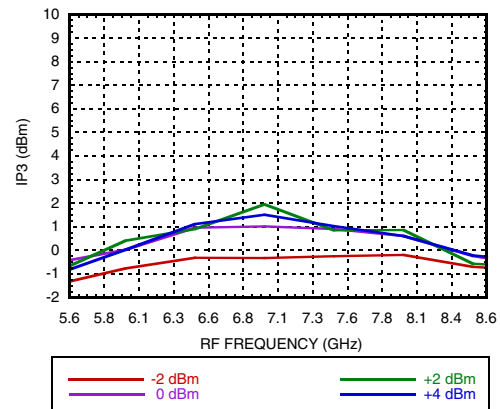

**Noise Figure vs. Frequency at Various Temperatures, LO Drive = +2 dBm, LSB**

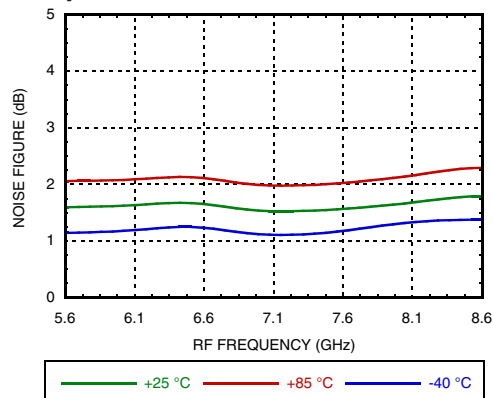

**Noise Figure vs. Frequency at Various LO Drives, LSB**

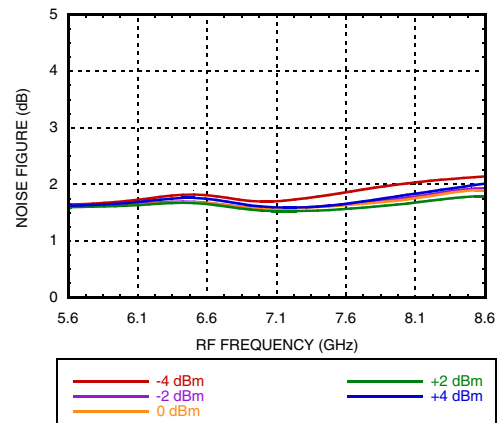

**GaAs MMIC I/Q DOWNCONVERTER  
5.6 - 8.6 GHz**

**Quadrature Channel Data Taken as Without External IF 90° Hybrid**

**Conversion Gain and Return Loss vs. IF Frequency, LO Drive = +2 dBm**

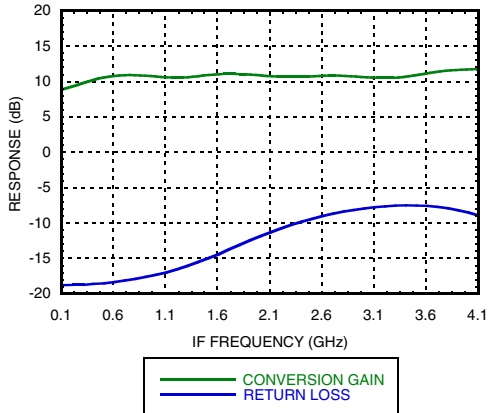

**Amplitude Balance vs. Frequency at Various Temperatures, LO Drive = +2 dBm**

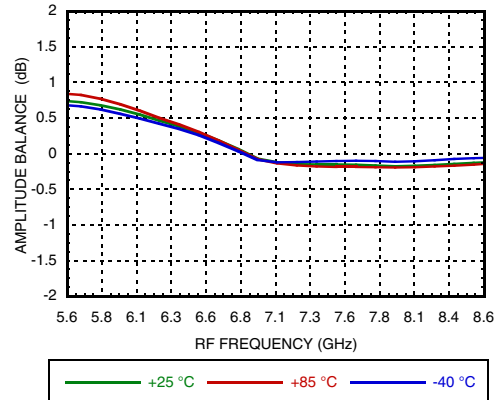

**Amplitude Balance vs. Frequency at Various LO Drives**

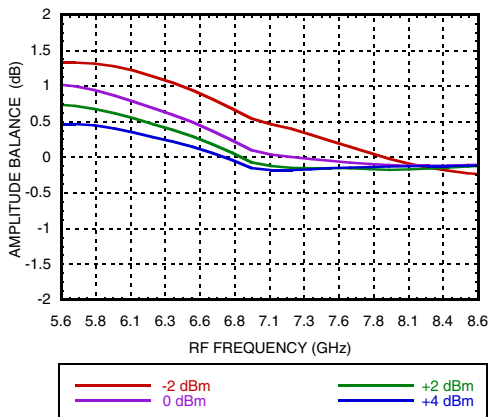

**Phase Balance vs. Frequency at Various Temperatures, LO Drive = +2 dBm**

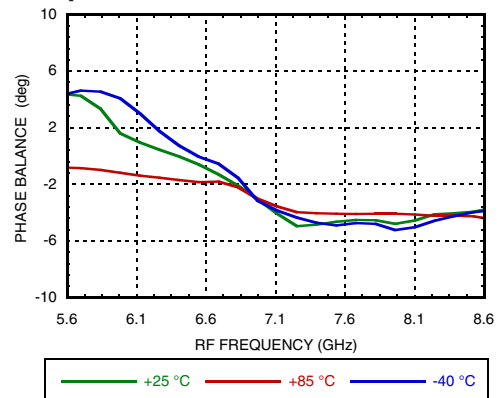

**Phase Balance vs. Frequency at Various LO Drives**

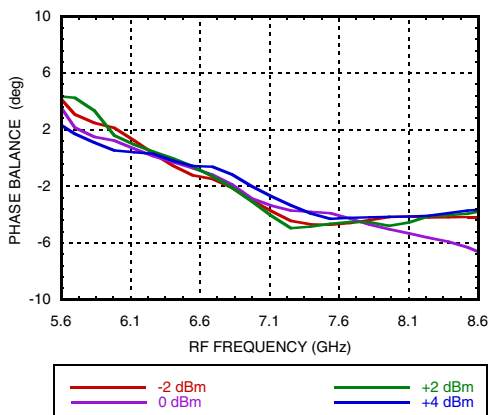

**GaAs MMIC I/Q DOWNCONVERTER  
5.6 - 8.6 GHz**

*Data Taken as IRM Downconverter with External IF 90° Hybrid, IF = 1000 MHz*

**Conversion Gain vs. Frequency at Various Temperatures, LO Drive = +2 dBm, USB**

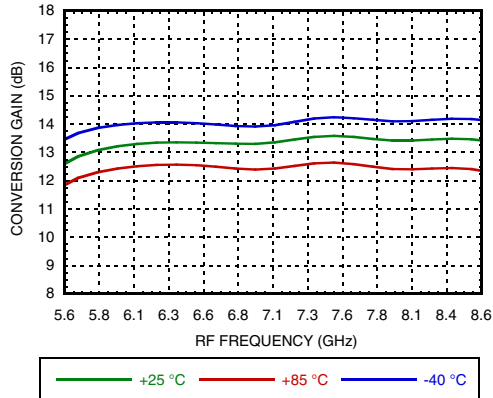

**Conversion Gain vs. Frequency at Various LO Drives, USB**

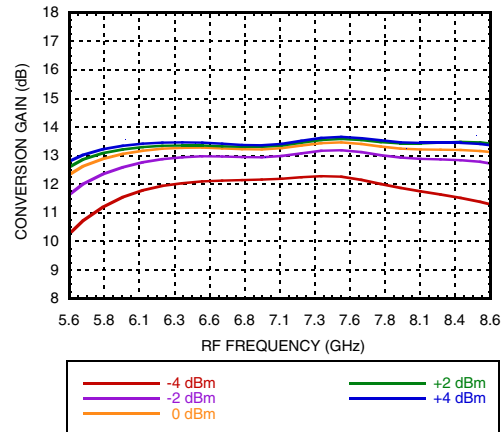

**Image Rejection vs. Frequency at Various Temperatures, LO Drive = +2 dBm, USB**

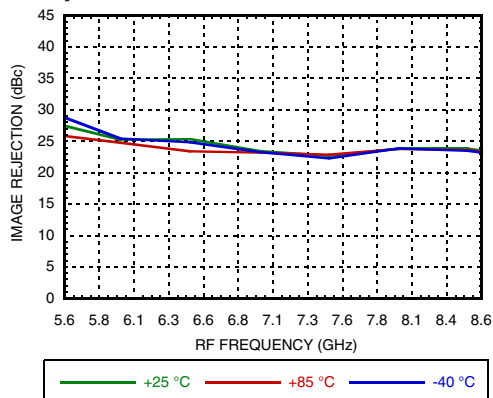

**Input P1dB vs. Frequency at Various Temperatures, LO Drive = +2 dBm, USB**

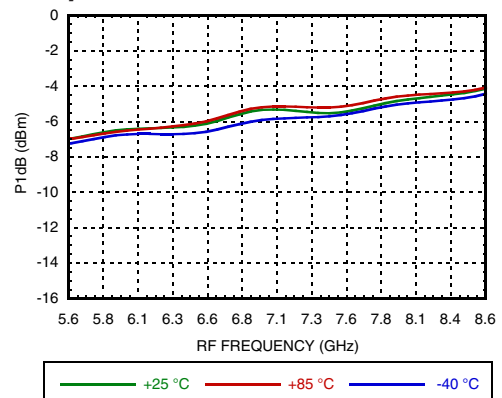

**Input IP3 vs. Frequency at Various Temperatures, LO Drive = +2 dBm, USB**

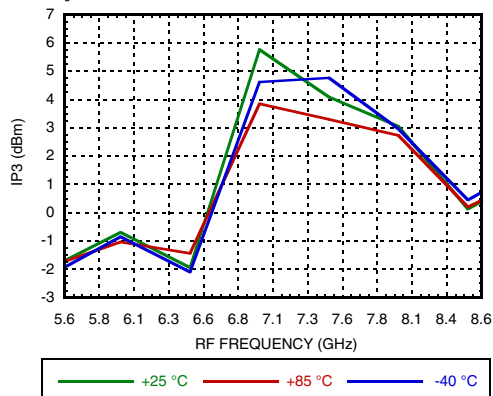

**Input IP3 vs. Frequency at Various LO Drives, USB**

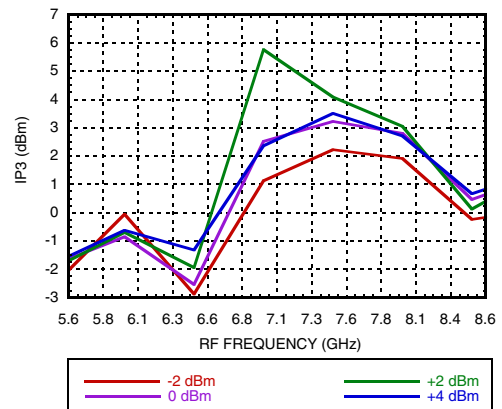

**GaAs MMIC I/Q DOWNCONVERTER  
5.6 - 8.6 GHz**

**Data Taken as IRM Downconverter with External IF 90° Hybrid, IF = 1000 MHz**

**Noise Figure vs. Frequency at Various Temperatures, LO Drive = +2 dBm, USB**

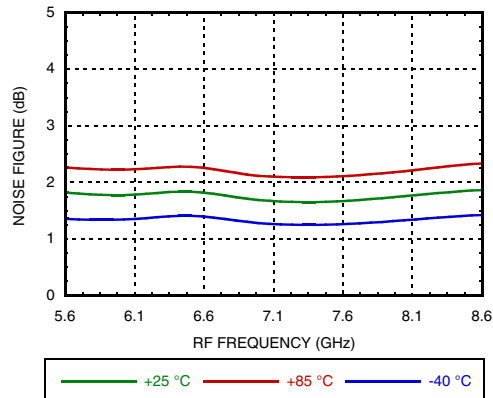

**Noise Figure vs. Frequency at Various LO Drives, USB**

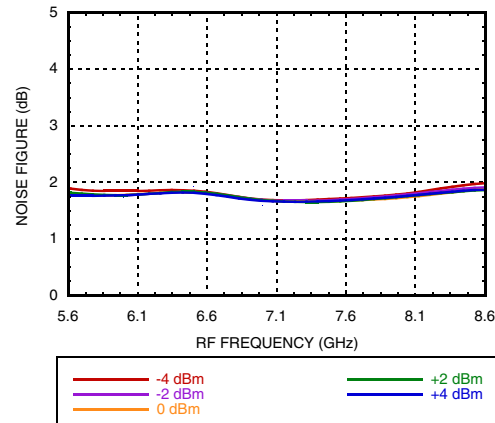

**GaAs MMIC I/Q DOWNCONVERTER**  
**5.6 - 8.6 GHz**

*Data Taken as IRM Downconverter with External IF 90° Hybrid, IF = 2000 MHz*

**Conversion Gain vs. Frequency at Various Temperatures, LO Drive = +2 dBm, LSB**

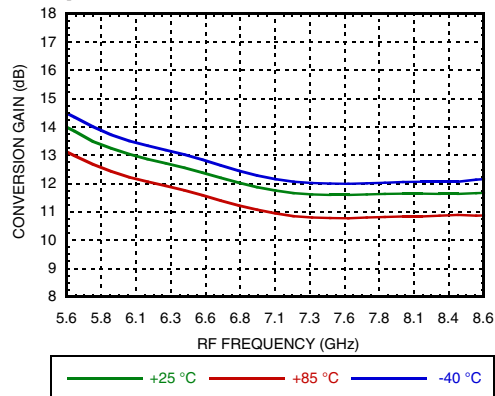

**Conversion Gain vs. Frequency at Various LO Drives, LSB**

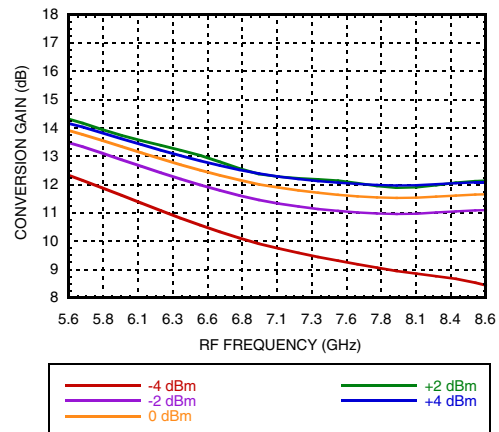

**Image Rejection vs. Frequency at Various Temperatures, LO Drive = +2 dBm, LSB**

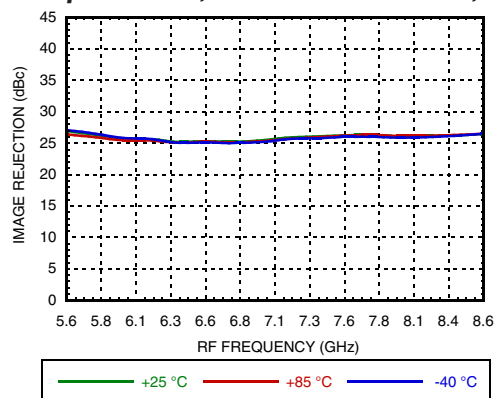

**Input P1dB vs. Frequency at Various Temperatures, LO Drive = +2 dBm, LSB**

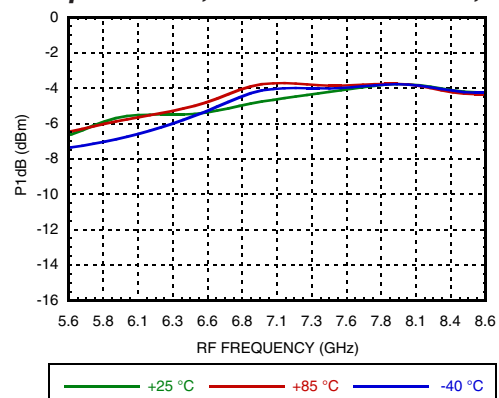

**Input IP3 vs. Frequency at Various Temperature, LO Drive = +2 dBm, LSB**

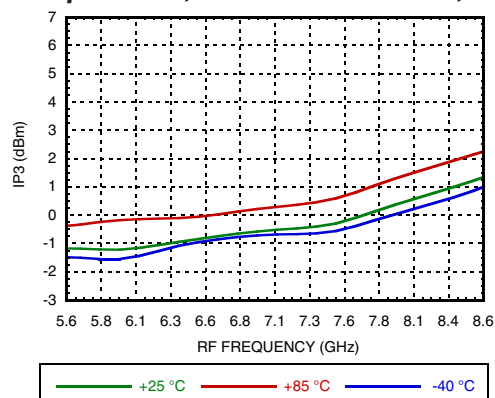

**Input IP3 vs. Frequency at Various LO Drives, LSB**

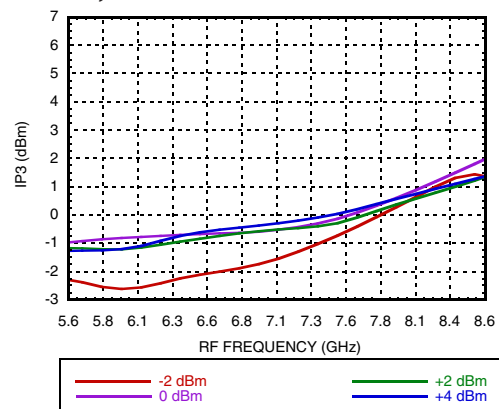

**GaAs MMIC I/Q DOWNCONVERTER  
5.6 - 8.6 GHz**

**Data Taken as IRM Downconverter with External IF 90° Hybrid, IF = 2000 MHz**

**Noise Figure vs. Frequency at Various Temperatures, LO Drive = +2 dBm, LSB**

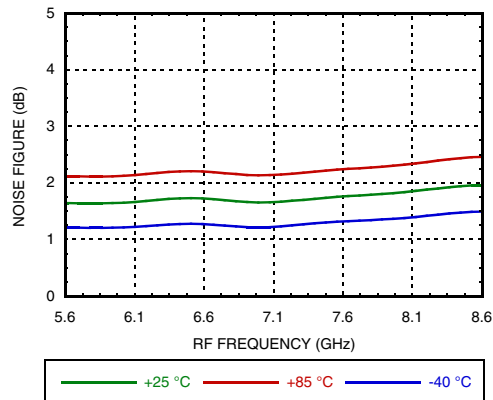

**Noise Figure vs. Frequency at Various LO Drives, LSB**

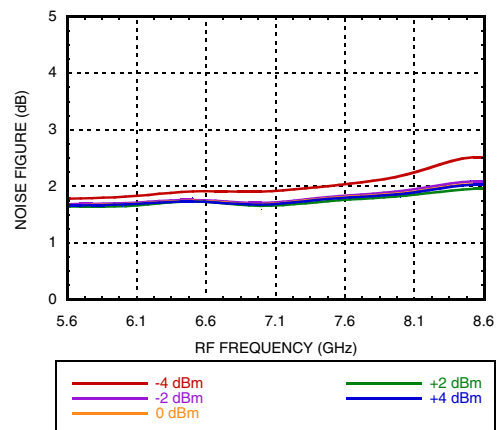

**GaAs MMIC I/Q DOWNCONVERTER  
5.6 - 8.6 GHz**

*Data Taken as IRM Downconverter with External IF 90° Hybrid, IF = 2000 MHz*

**Conversion Gain vs. Frequency at Various Temperatures, LO Drive = +2 dBm, USB**

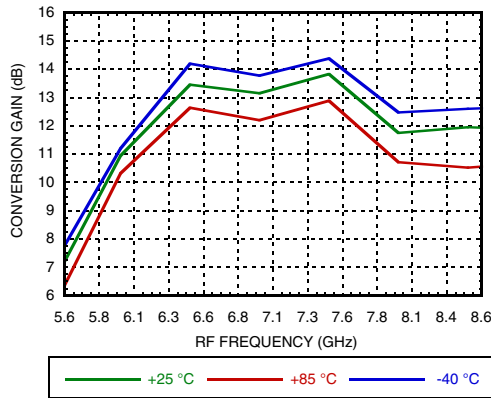

**Conversion Gain vs. Frequency at Various LO Drives, USB**

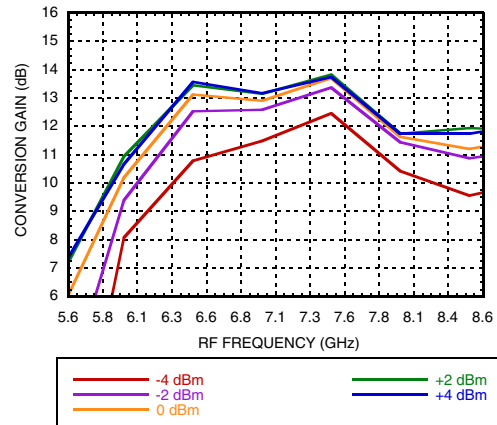

**Image Rejection vs. Frequency at Various Temperatures, LO Drive = +2 dBm, USB**

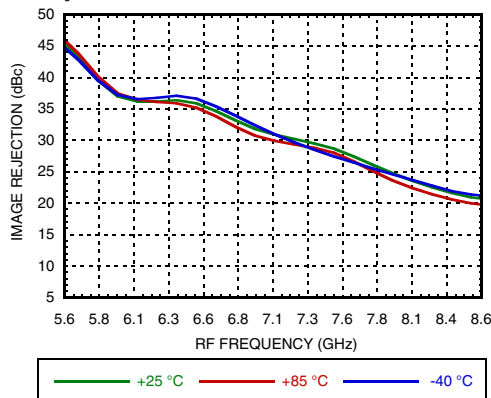

**Input P1dB vs. Frequency at Various Temperatures, LO Drive = +2 dBm, USB**

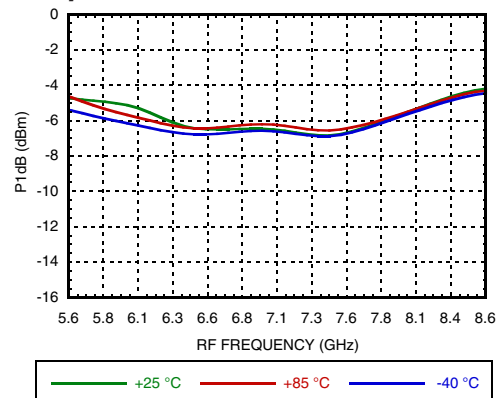

**Input IP3 vs. Frequency at Various Temperatures, LO Drive = +2 dBm, USB**

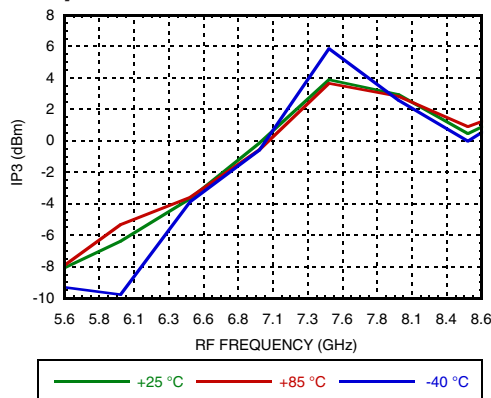

**Input IP3 vs. Frequency at Various LO Drives, USB**

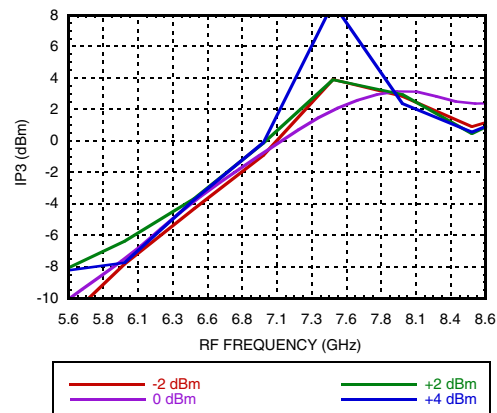

**GaAs MMIC I/Q DOWNCONVERTER  
5.6 - 8.6 GHz**

**Data Taken as IRM Downconverter with External IF 90° Hybrid, IF = 2000 MHz**

**Noise Figure vs. Frequency at Various Temperatures, LO Drive = +2 dBm, USB**

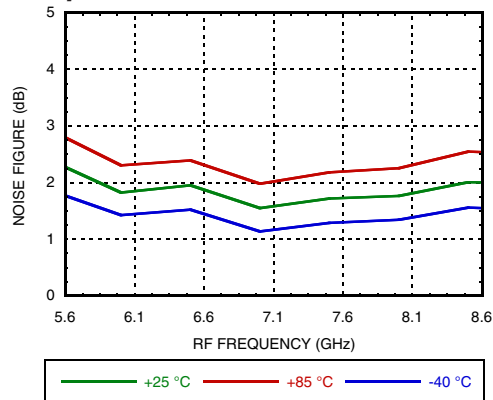

**Noise Figure vs. Frequency at Various LO Drives, USB**

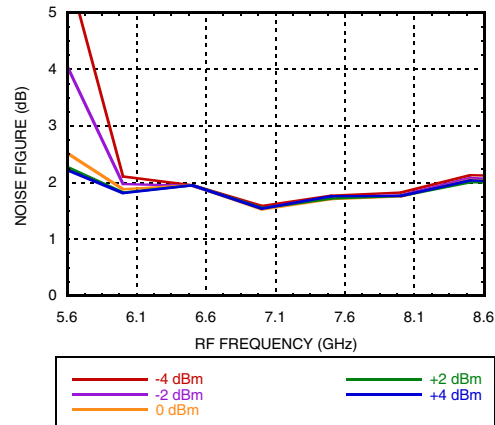

**GaAs MMIC I/Q DOWNCONVERTER**  
**5.6 - 8.6 GHz**

*Data Taken as IRM Downconverter with External IF 90° Hybrid, IF = 3500 MHz*

**Conversion Gain vs. Frequency at Various Temperatures, LO Drive = +2 dBm, LSB**

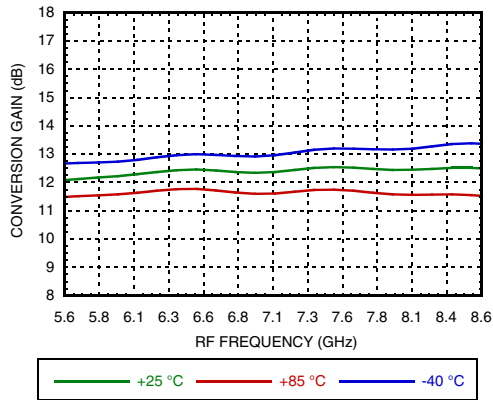

**Conversion Gain vs. Frequency at Various LO Drives, LSB**

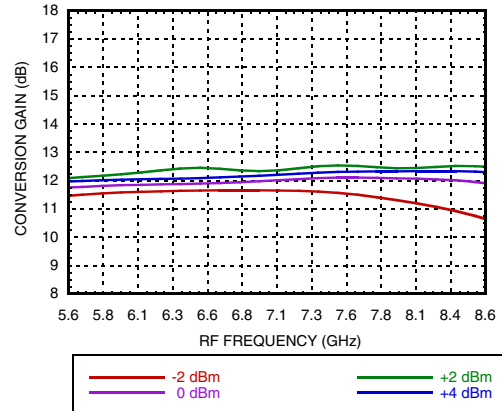

**Image Rejection vs. Frequency at Various Temperatures, LO Drive = +2 dBm, LSB**

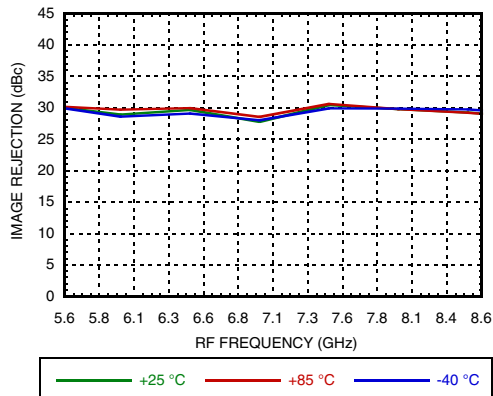

**Input P1dB vs. Frequency at Various Temperatures, LO Drive = +2 dBm, LSB**

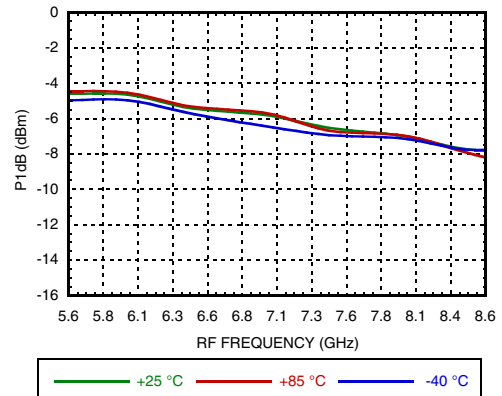

**Input IP3 vs. Frequency at Various Temperatures, LO Drive = +2 dBm, LSB**

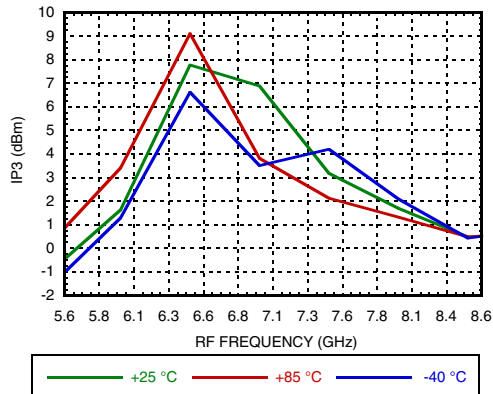

**Input IP3 vs. Frequency at Various LO Drives, LSB**

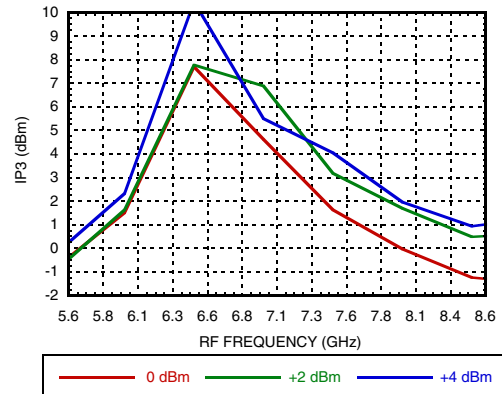

**GaAs MMIC I/Q DOWNCONVERTER  
5.6 - 8.6 GHz**

**Data Taken as IRM Downconverter with External IF 90° Hybrid, IF = 3500 MHz**

**Noise Figure vs. Frequency at Various Temperatures, LO Drive = +2 dBm, LSB**

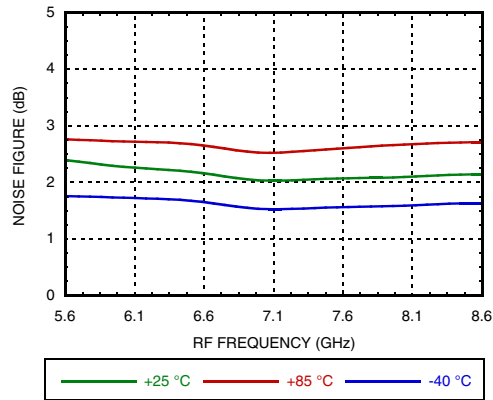

**Noise Figure vs. Frequency at Various LO Drives, LSB**

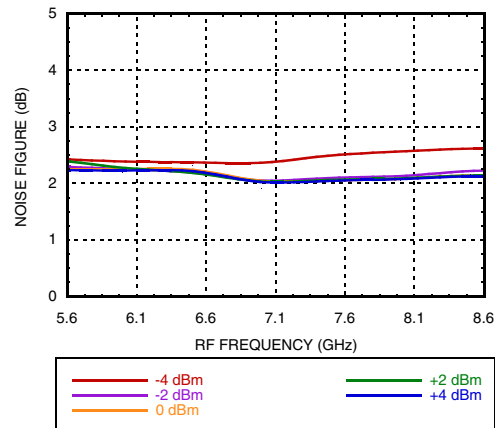

## GaAs MMIC I/Q DOWNCONVERTER 5.6 - 8.6 GHz

### MxN Spurious Outputs

mRF	nLO					
	0	1	2	3	4	5
0		2.4	23	32.6	29.7	34.6
1	8.5	0	23	46.2	48.9	58.4
2	58.4	47.7	41.4	60.8	52.1	58.2
3	56.8	70.8	54.4	52.9	59.1	75.8
4	80.9	84.8	71.8	68.9	67.4	76.4
5	84.4	85.8	83.5	86.4	73.1	67.3

RF = 6.1 GHz at RF input power = -20 dBm

LO = 7.1 GHz at LO input power = +2 dBm

All values in dBc from IF output power level (LO - RF)

Spur values are (M x RF) - (N x LO)

### Absolute Maximum Ratings

VDD (VDRF, VDLO)	4.5 V
LO Drive	+20 dBm
Channel Temperature	175 °C
Continuous P <sub>diss</sub> (T=85°C derate 13.16 mW/°C above 85°C)	1.184 W
Thermal Resistance (R <sub>th</sub> ) (channel to package bottom)	76 °C/W
Storage Temperature Range	-65 to +150 °C
Operating Temperature Range	-40 °C to +85 °C
ESD Sensitivity (HBM)	150 V (Class 0)

### Outline Drawing

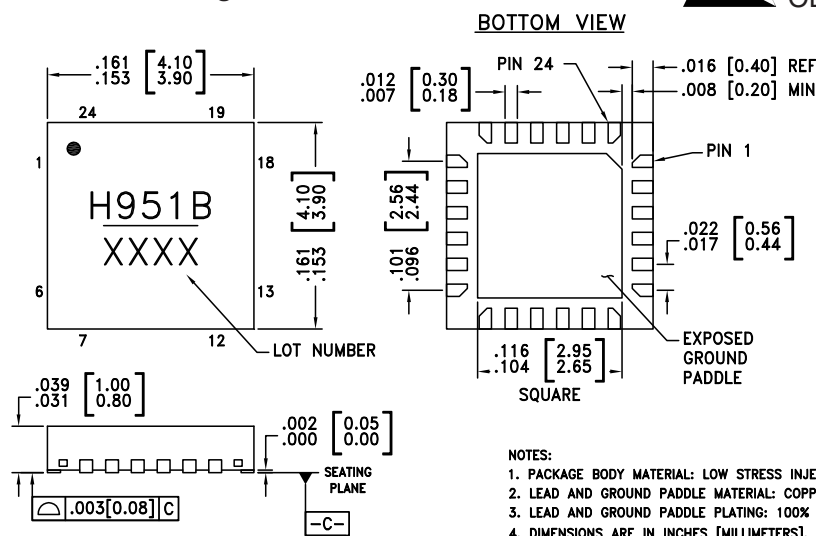

**ELECTROSTATIC SENSITIVE DEVICE  
OBSERVE HANDLING PRECAUTIONS**

#### NOTES:

1. PACKAGE BODY MATERIAL: LOW STRESS INJECTION MOLDED PLASTIC SILICA AND SILICON IMPREGNATED.
2. LEAD AND GROUND PADDLE MATERIAL: COPPER ALLOY.
3. LEAD AND GROUND PADDLE PLATING: 100% MATTE TIN
4. DIMENSIONS ARE IN INCHES [MILLIMETERS].
5. LEAD SPACING TOLERANCE IS NON-CUMULATIVE.
6. CHARACTERS TO BE HELVETICA MEDIUM, .025 HIGH, WHITE INK, OR LASER MARK LOCATED APPROX. AS SHOWN.
7. PAD BURR LENGTH SHALL BE 0.15mm MAX. PAD BURR HEIGHT SHALL BE 0.05mm MAX.
8. PACKAGE WARP SHALL NOT EXCEED 0.05mm
9. ALL GROUND LEADS AND GROUND PADDLE MUST BE SOLDERED TO PCB RF GROUND.
10. REFER TO HITTITE APPLICATION NOTE FOR SUGGESTED PCB LAND PATTERN.





Part Number	Package Body Material	Lead Finish	MSL Rating	Package Marking <sup>[2]</sup>
HMC951BLP4E	RoHS-compliant Low Stress Injection Molded Plastic	100% matte Sn	MSL3 <sup>[1]</sup>	H951B XXXX

[1] Max peak reflow temperature of 260 °C

[2] 4-Digit lot number XXXX

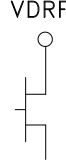
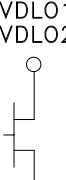
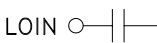
## GaAs MMIC I/Q DOWNCONVERTER 5.6 - 8.6 GHz

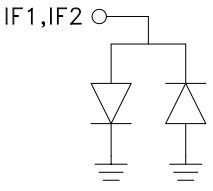
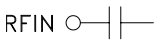
### Pin Descriptions

Pin Number	Function	Description	Interface Schematic
1, 2, 6, 7, 10 - 12, 15, 18 - 22	NIC	No internal connection. These pins are not connected internally. However, all data shown herein was measured with these pins connected to RF/dc ground externally.	
3	VDRF	Power supply for the low noise amplifier (LNA). External bypass capacitors of 100 pF, 0.01 $\mu$ F and 4.7 $\mu$ F are recommended.	
4	VDLO2	Power supply for the second stage of the LO amplifier. External bypass capacitors of 100 pF, 0.01 $\mu$ F and 4.7 $\mu$ F are recommended.	
5	VDLO1	Power Supply for the first stage of the LO amplifier. External bypass capacitors of 100 pF, 0.01 $\mu$ F and 4.7 $\mu$ F are recommended.	
8	LOIN	Local Oscillator input. This pin is ac coupled and matched to 50 Ohms.	
9, 13, 17, 24	GND	Ground connect. These pins and the exposed ground paddle must be connected to RF/dc ground.	
14	IF1	Intermediate Frequency ports. These pins are dc coupled. For applications not requiring operation to dc, block these pins externally using a series capacitor with a value chosen to pass the necessary frequency range. For operation to dc, these pins must not sink / source more than 3 mA of current or part non-function and possible failure may result.	
16	IF2		
23	RFIN	Radio Frequency Input. This pin is ac coupled and matched to 50 Ohms.	
	EPAD	Exposed Paddle. Connect to a low impedance thermal and electrical ground plane.	

**GaAs MMIC I/Q DOWNCONVERTER  
5.6 - 8.6 GHz**

**Application Circuit**

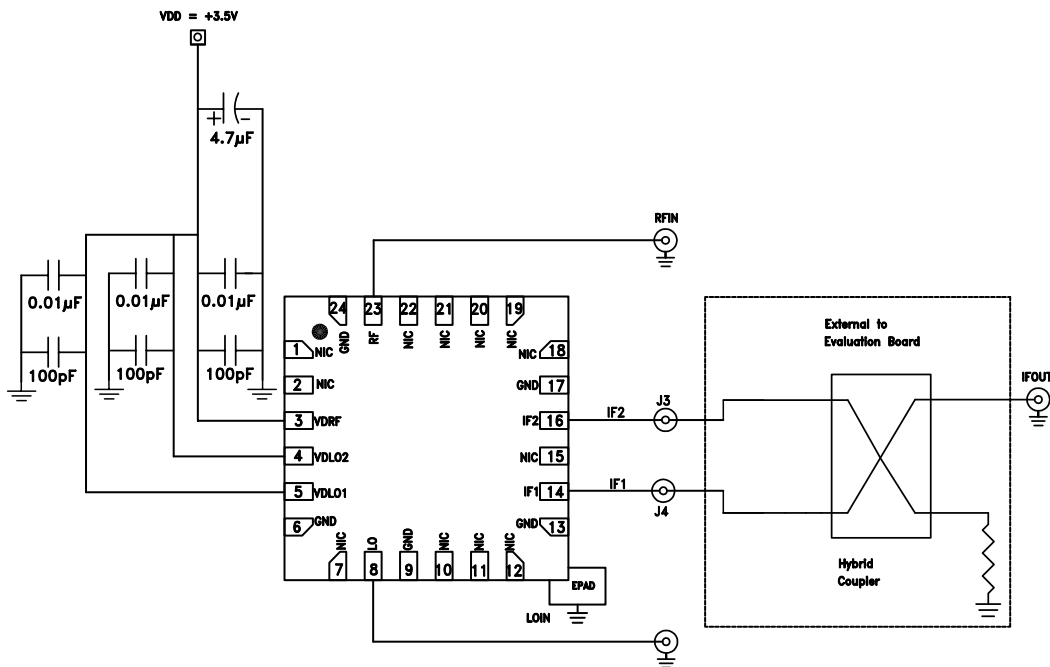
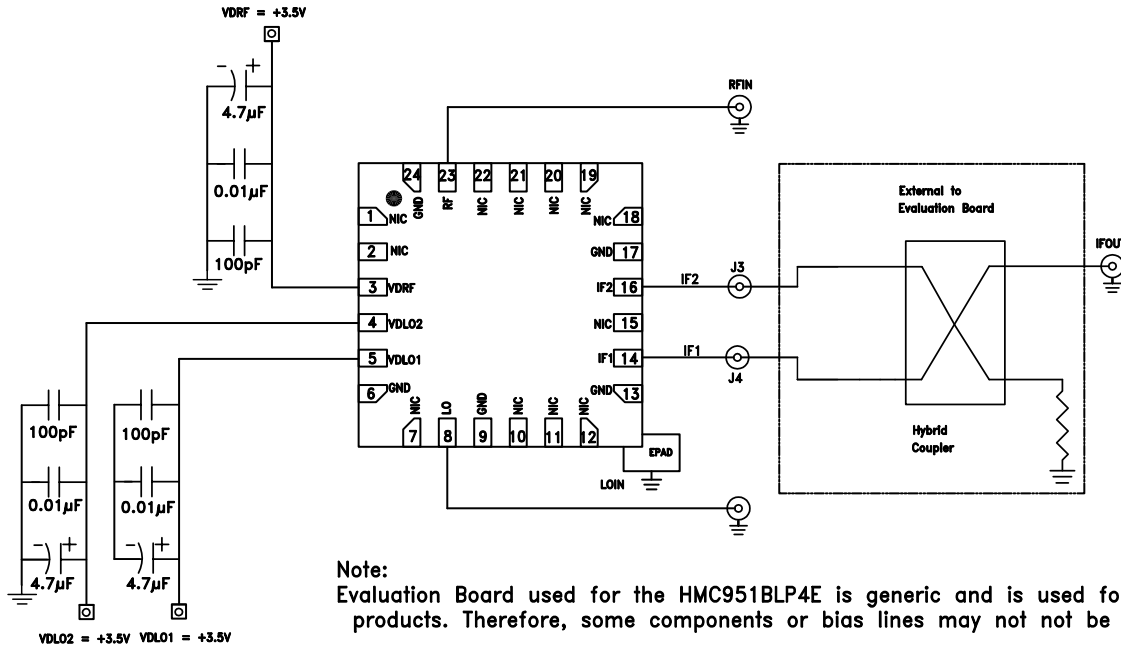

**GaAs MMIC I/Q DOWNCONVERTER  
5.6 - 8.6 GHz**

**Evaluation PCB**

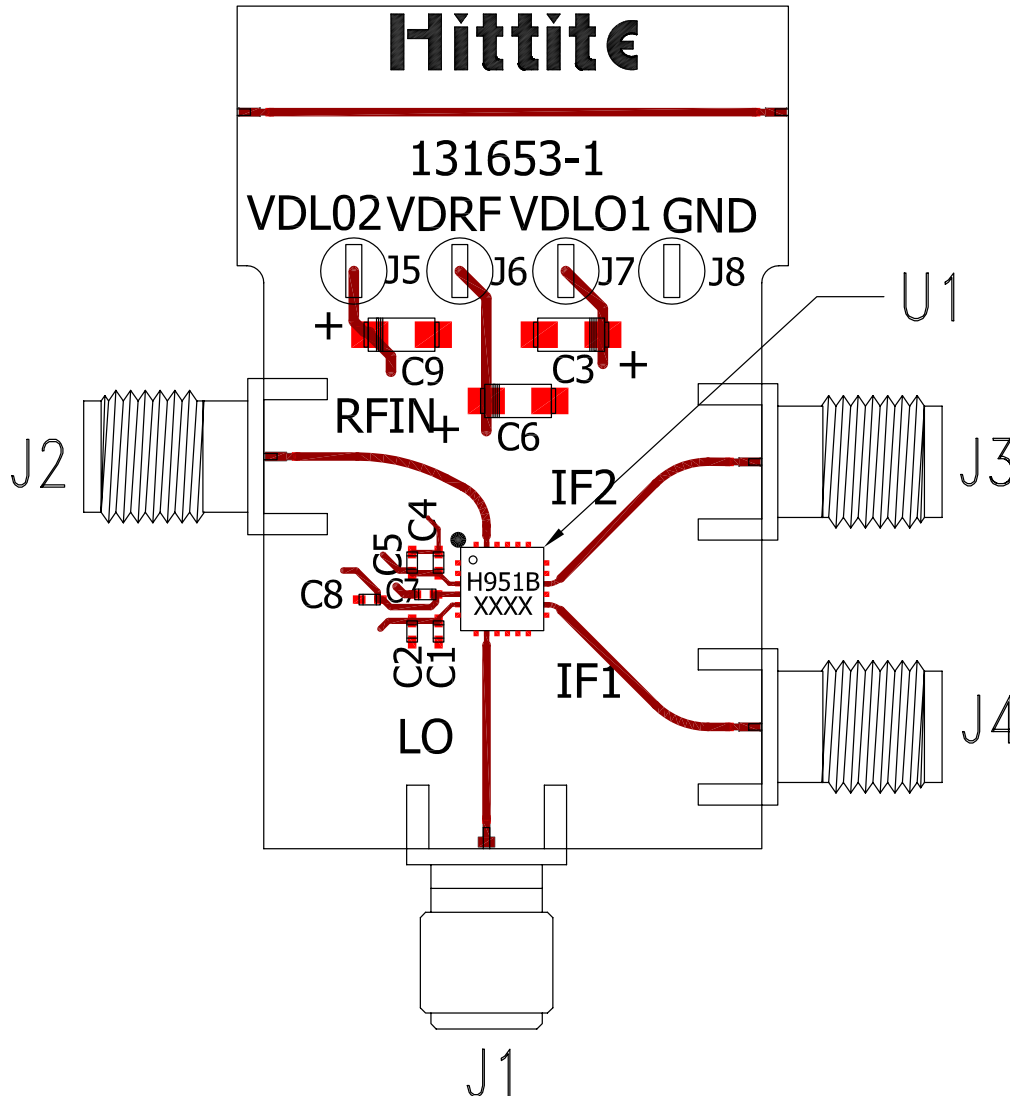

**List of Materials for Evaluation PCB EV1HMC951BLP4 [1]**

Item	Description
J1	PCB Mount SMA RF Connector, SRI
J2, J3	PCB Mount K Connector, SRI
J5 - J8	DC Pins
C1, C4, C7	100 pF Capacitor, 0402 Pkg.
C2, C5, C8	10 nF Capacitor, 0402 Pkg.
C3, C6, C9	4.7 μF Capacitor, Case A Pkg.
U1	HMC951BLP4E
PCB [2]	161653 Evaluation Board PCB

[1] Reference this number when ordering complete evaluation PCB

[2] Circuit Board Material: Rogers 4350

The circuit board used in the application should use RF circuit design techniques. Signal lines should have 50 Ohm impedance while the package ground leads and exposed paddle should be connected directly to the ground plane similar to that shown. A sufficient number of via holes should be used to connect the top and bottom ground planes. The evaluation circuit board shown is available from Analog Devices upon request.

## Looking for pricing, stock, or lifecycle information?

Click below to explore more details on WIN SOURCE:

 [View HMC951BLP4E on WIN SOURCE](#)

 [Analog Devices Inc. Information](#)

## Optimize Your Supply Chain with WIN SOURCE Solutions

-  Global Sourcing Solution
-  Obsolete Management
-  Cost Control Management
-  Shortage Management
-  Alternative Solution
-  Excess Inventory Management