

ISL3170E, ISL3171E, ISL3172E, ISL3173E, ISL3174E, ISL3175E, ISL3176E, ISL3177E, ISL3178E
 ±15kV ESD Protected, 3.3V, Full Fail-Safe, Low Power, High Speed or Slew Rate
 Limited, RS-485/RS-422 Transceivers

The Renesas ISL317xE ([ISL3170E](#), [ISL3171E](#), [ISL3172E](#), [ISL3173E](#), [ISL3174E](#), [ISL3175E](#), [ISL3176E](#), [ISL3177E](#), [ISL3178E](#)) are ±15kV IEC61000 ESD protected, 3.3V powered single transceivers that meet both the RS-485 and RS-422 standards for balanced communication. These devices have very low bus currents (+125µA/-100µA), so they present a true “1/8 unit load” to the RS-485 bus. This allows up to 256 transceivers on the network without violating the RS-485 specification’s 32 unit load maximum, and without using repeaters. For example, in a remote utility meter reading system, individual meter readings are routed to a concentrator using an RS-485 network, so the high allowed node count minimizes the number of repeaters required.

Receiver (Rx) inputs feature a “Full Fail-Safe” design, which ensures a logic high Rx output if Rx inputs are floating, shorted, or terminated but undriven.

Hot Plug circuitry ensures that the Tx and Rx outputs remain in a high impedance state while the power supply stabilizes.

The ISL3170E through ISL3175E utilize slew rate limited drivers which reduce EMI, and minimize reflections from improperly terminated transmission lines, or unterminated stubs in multidrop and multipoint applications. Slew rate limited versions also include receiver input filtering to enhance noise immunity in the presence of slow input signals.

The ISL3170E, ISL3171E, ISL3173E, ISL3174E, ISL3176E, and ISL3177E are configured for full duplex (separate Rx input and Tx output pins) applications. The half duplex versions multiplex the Rx inputs and Tx outputs to allow transceivers with output disable functions in 8 Ld packages.

Features

- IEC61000-4-2 ESD protection on RS-485 I/O pins . . . ±15kV
 - HBM Class 3 ESD level on all other pins >7kV
- Full fail-safe (open, short, terminated/floating) receivers
- Hot plug - Tx and Rx outputs remain three-state during power-up (only versions with output enable pins)
- True 1/8 unit load allows up to 256 devices on the bus
- Single 3.3V supply
- High data rates up to 20Mbps
- Low quiescent supply current 800µA (Max)
 - Ultra low shutdown supply current 10nA
- -7V to +12V common-mode input/output voltage range
- Half and full duplex pinouts
- Three state Rx and Tx outputs available
- Current limiting and thermal shutdown for driver overload protection
- Tiny MSOP packages consume 50% less board space
- Pb-free (RoHS compliant)

Applications

- Automated utility meter reading systems
- High node count systems
- Field bus networks
- Security camera networks
- Building environmental control/lighting systems
- Industrial/process control networks

TABLE 1. SUMMARY OF FEATURES

PART NUMBER	HALF/FULL DUPLEX	DATA RATE (Mbps)	SLEW-RATE LIMITED?	HOT PLUG?	# DEVICES ON BUS	RX/TX ENABLE?	QUIESCENT I _{CC} (µA)	LOW POWER SHUTDOWN?	PIN COUNT
ISL3170E	Full	0.25	Yes	Yes	256	Yes	510	Yes	10, 14
ISL3171E	Full	0.25	Yes	No	256	No	510	No	8
ISL3172E	Half	0.25	Yes	Yes	256	Yes	510	Yes	8
ISL3173E	Full	0.5	Yes	Yes	256	Yes	510	Yes	10, 14
ISL3174E	Full	0.5	Yes	No	256	No	510	No	8
ISL3175E	Half	0.5	Yes	Yes	256	Yes	510	Yes	8
ISL3176E	Full	20	No	Yes	256	Yes	510	Yes	10, 14
ISL3177E	Full	20	No	No	256	No	510	No	8
ISL3178E	Half	20	No	Yes	256	Yes	510	Yes	8

Ordering Information

PART NUMBER (Notes 2, 3)	PART MARKING	PACKAGE DESCRIPTION (RoHS Compliant)	PKG. DWG. #	CARRIER TYPE (Note 1)	TEMP. RANGE
ISL3170EIBZ	3170EIBZ	14 Ld SOIC	M14.15	Tube	-40 to +85°C
ISL3170EIBZ-T				Reel, 2.5k	
ISL3170EIBZ-T7A				Reel, 250	
ISL3170EIUZ	3170Z	10 Ld MSOP	M10.118	Tube	
ISL3170EIUZ-T				Reel, 2.5k	
ISL3171EIBZ	3171 EIBZ	8 Ld SOIC	M8.15	Tube	
ISL3171EIBZ-T				Reel, 2.5k	
ISL3171EIBZ-T7A				Reel, 250	
ISL3171EIUZ	3171Z	8 Ld MSOP	M8.118	Tube	
ISL3171EIUZ-T				Reel, 2.5k	
ISL3172EIBZ	3172 EIBZ	8 Ld SOIC	M8.15	Tube	
ISL3172EIBZ-T				Reel, 2.5k	
ISL3172EIBZ-T7A				Reel, 250	
ISL3172EIUZ	3172Z	8 Ld MSOP	M8.118	Tube	
ISL3172EIUZ-T				Reel, 2.5k	
ISL3173EIBZ	3173EIBZ	14 Ld SOIC	M14.15	Tube	
ISL3173EIBZ-T				Reel, 2.5k	
ISL3173EIUZ	3173Z	10 Ld MSOP	M10.118	Tube	
ISL3173EIUZ-T				Reel, 2.5k	
ISL3174EIBZ No longer available, recommended replacement: ISL3177EIBZ	3174 EIBZ	8 Ld SOIC	M8.15	Tube	
ISL3174EIBZ-T No longer available, recommended replacement: ISL3177EIBZ-T				Reel, 2.5k	
ISL3174EIUZ	3174Z	8 Ld MSOP	M8.118	Tube	
ISL3174EIUZ-T				Reel, 2.5k	
ISL3175EIBZ	3175 EIBZ	8 Ld SOIC	M8.15	Tube	
ISL3175EIBZ-T				Reel, 2.5k	
ISL3175EIUZ	3175Z	8 Ld MSOP	M8.118	Tube	
ISL3175EIUZ-T				Reel, 2.5k	
ISL3176EIBZ	3176EIBZ	14 Ld SOIC	M14.15	Tube	
ISL3176EIBZ-T				Reel, 2.5k	
ISL3176EIUZ	3176Z	10 Ld MSOP	M10.118	Tube	
ISL3176EIUZ-T				Reel, 2.5k	
ISL3176EIUZ-T7A				Reel, 250	
ISL3177EIBZ	3177 EIBZ	8 Ld SOIC	M8.15	Tube	
ISL3177EIBZ-T				Reel, 2.5k	
ISL3177EIUZ	3177Z	8 Ld MSOP	M8.118	Tube	
ISL3177EIUZ-T				Reel, 2.5k	

PART NUMBER (Notes 2, 3)	PART MARKING	PACKAGE DESCRIPTION (RoHS Compliant)	PKG. DWG. #	CARRIER TYPE (Note 1)	TEMP. RANGE
ISL3178EIBZ	3178 EIBZ	8 Ld SOIC	M8.15	Tube	-40 to +85°C
ISL3178EIBZ-T				Reel, 2.5k	
ISL3178EIBZ-T7A				Reel, 250	
ISL3178EIUZ	3178Z	8 Ld MSOP	M8.118	Tube	
ISL3178EIUZ-T				Reel, 2.5k	

NOTES:

- See [TB347](#) for details about reel specifications.
- These Pb-free plastic packaged products employ special Pb-free material sets, molding compounds/die attach materials, and 100% matte tin plate plus anneal (e3 termination finish, which is RoHS compliant and compatible with both SnPb and Pb-free soldering operations). Pb-free products are MSL classified at Pb-free peak reflow temperatures that meet or exceed the Pb-free requirements of IPC/JEDEC J STD-020.
- For Moisture Sensitivity Level (MSL), see the product information page for the [ISL3170E](#), [ISL3171E](#), [ISL3172E](#), [ISL3173E](#), [ISL3174E](#), [ISL3175E](#), [ISL3176E](#), [ISL3177E](#), [ISL3178E](#). For more information on MSL refer to [TB363](#).

Pinouts

ISL3172E, ISL3175E, ISL3178E
(8 LD MSOP, SOIC)
TOP VIEW

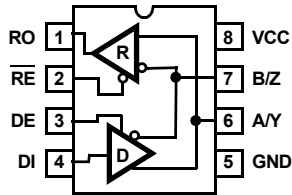

ISL3171E, ISL3174E, ISL3177E
(8 LD MSOP, SOIC)
TOP VIEW

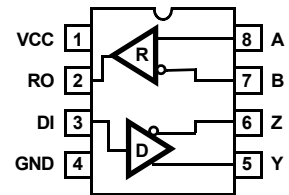

ISL3170E, ISL3173E, ISL3176E
(10 LD MSOP)
TOP VIEW

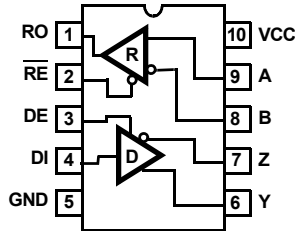

ISL3170E, ISL3173E, ISL3176E
(14 LD SOIC)
TOP VIEW

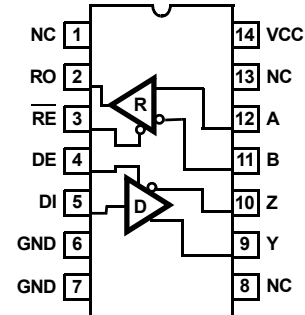

Truth Tables

TRANSMITTING				
INPUTS			OUTPUTS	
RE	DE	DI	Z	Y
X	1	1	0	1
X	1	0	1	0
0	0	X	High-Z	High-Z
1	0	X	High-Z*	High-Z*

NOTE: *Shutdown Mode (see [Note 10](#) on [page 10](#)), except for the ISL3171E, ISL3174E, ISL3177E.

RECEIVING				
RE	INPUTS		A-B	OUTPUT
	Half Duplex	Full Duplex		
0	0	X	$V_{AB} \geq -0.05V$	1
0	0	X	$-0.05V > V_{AB} > -0.2V$	Undetermined
0	0	X	$V_{AB} \leq -0.2V$	0
0	0	X	Inputs Open/Shorted	1
1	0	X	X	High-Z*
1	1	X	X	High-Z

NOTE: *Shutdown Mode (see [Note 10](#)), except for the ISL3171E, ISL3174E, ISL3177E.

Pin Descriptions

PIN	FUNCTION
RO	Receiver output: If $A-B \geq -50mV$, RO is high; If $A-B \leq -200mV$, RO is low; if A and B are unconnected (floating) or shorted, RO = High.
\overline{RE}	Receiver output enable. RO is enabled when \overline{RE} is low; RO is high impedance when \overline{RE} is high. If the Rx enable function is not required, connect \overline{RE} directly to GND or through a 1kΩ to 3kΩ resistor to GND.
DE	Driver output enable. The driver outputs, Y and Z, are enabled by bringing DE high, and are high impedance when DE is low. If the Tx enable function is not required, connect DE to V_{CC} through a 1kΩ to 3kΩ resistor.
DI	Driver input. A low on DI forces output Y low and output Z high. Similarly, a high on DI forces output Y high and output Z low.
GND	Ground connection.
A/Y	$\pm 15kV$ IEC61000 ESD Protected RS-485/422 level, noninverting receiver input and noninverting driver output. Pin is an input if DE = 0; pin is an output if DE = 1.
B/Z	$\pm 15kV$ IEC61000 ESD Protected RS-485/422 level, Inverting receiver input and inverting driver output. Pin is an input if DE = 0; pin is an output if DE = 1.
A	$\pm 15kV$ IEC61000 ESD Protected RS-485/422 level, noninverting receiver input.
B	$\pm 15kV$ IEC61000 ESD Protected RS-485/422 level, inverting receiver input.
Y	$\pm 15kV$ IEC61000 ESD Protected RS-485/422 level, noninverting driver output.
Z	$\pm 15kV$ IEC61000 ESD Protected RS-485/422 level, inverting driver output.
V_{CC}	System power supply input (3.0V to 3.6V).
NC	No Connection.

Typical Operating Circuits

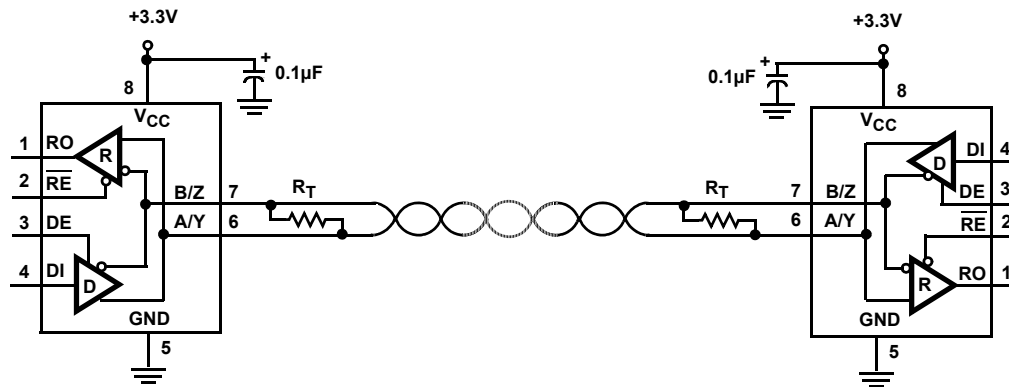

FIGURE 1. ISL3172E, ISL3175E, ISL3178E

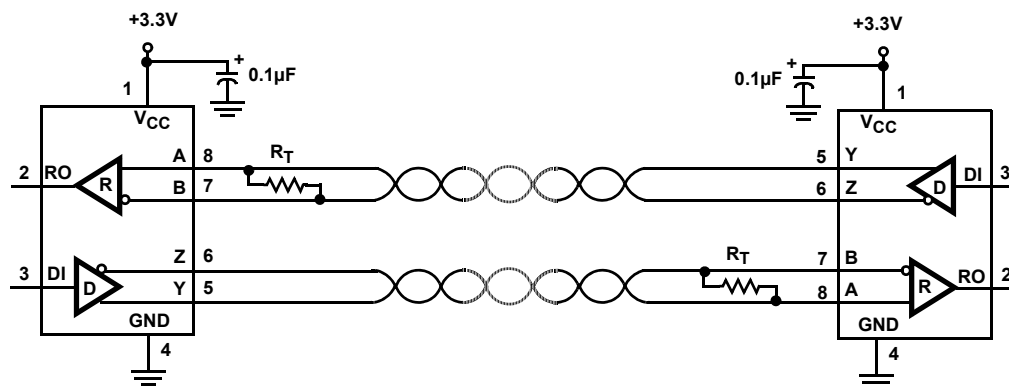

FIGURE 2. ISL3171E, ISL3174E, ISL3177E

Typical Operating Circuits (Continued)

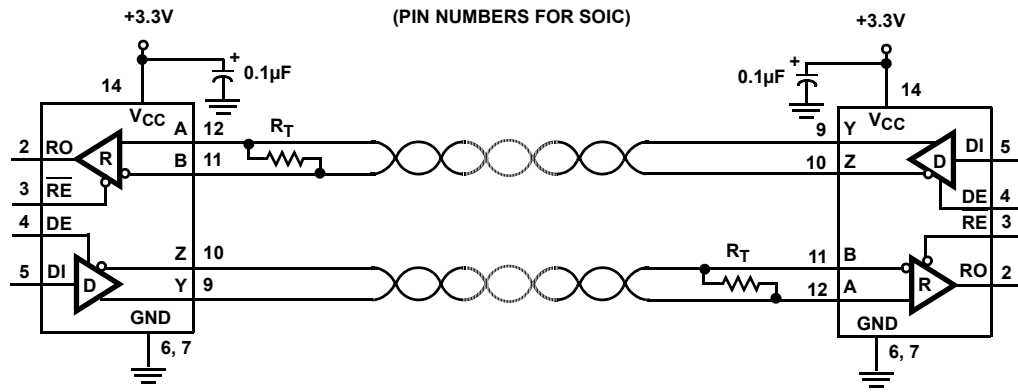

FIGURE 3. ISL3170E, ISL3173E, ISL3176E

Absolute Maximum Ratings

V _{CC} to GND	7V
Input Voltages	
DI	-0.3V to 7V
DE, RE (Note 20)	-0.3V to 7V
Input/Output Voltages	
A, B, Y, Z	-8V to +13V
RO	-0.3V to (V _{CC} +0.3V)
Short Circuit Duration	
Y, Z	Continuous
ESD Rating	See Electrical Specifications Table

Thermal Information

Thermal Resistance (Typical, Note 4)	θ _{JA} (°C/W)
8 Ld SOIC Package	105
8 Ld MSOP Package	140
10 Ld MSOP Package	190
14 Ld SOIC Package	128
Maximum Junction Temperature (Plastic Package)	+150°C
Maximum Storage Temperature Range	-65°C to +150°C
Pb-Free Reflow Profile	see TB493

Operating Conditions

Temperature Range	-40°C to +85°C
-------------------	----------------

CAUTION: Do not operate at or near the maximum ratings listed for extended periods of time. Exposure to such conditions may adversely impact product reliability and result in failures not covered by warranty.

NOTE:

- 4. θ_{JA} is measured with the component mounted on a high-effective thermal conductivity test board in free air. Refer to TB379 for details.

Electrical Specifications Test Conditions: V_{CC} = 3.0V to 3.6V; unless otherwise specified. Typical values are at V_{CC} = 3.3V, T_A = +25°C, (Note 5)

PARAMETER	SYMBOL	TEST CONDITIONS	TEMP (°C)	MIN (Note 19)	TYP	MAX (Note 19)	UNITS	
DC CHARACTERISTICS								
Driver Differential V _{OUT}	V _{OD}	R _L = 100Ω (RS-422) (Figure 4A, Note 16)	Full	2	2.3	-	V	
		R _L = 54Ω (RS-485) (Figure 4A)	Full	1.5	2	V _{CC}	V	
		No Load		-	-	V _{CC}		
		R _L = 60Ω, -7V ≤ V _{CM} ≤ 12V (Figure 4B)	Full	1.5	2.2	-	V	
Change in Magnitude of Driver Differential V _{OUT} for Complementary Output States	ΔV _{OD}	R _L = 54Ω or 100Ω (Figure 4A)	Full	-	0.01	0.2	V	
Driver Common-Mode V _{OUT}	V _{OC}	R _L = 54Ω or 100Ω (Figure 4A)	Full	-	2	3	V	
Change in Magnitude of Driver Common-Mode V _{OUT} for Complementary Output States	ΔV _{OC}	R _L = 54Ω or 100Ω (Figure 4A)	Full	-	0.01	0.2	V	
Logic Input High Voltage	V _{IH}	DI, DE, RE	Full	2	-	-	V	
Logic Input Low Voltage	V _{IL}	DI, DE, RE	Full	-	-	0.8	V	
Logic Input Hysteresis	V _{HYS}	DE, RE (Note 15)	25	-	100	-	mV	
Logic Input Current	I _{IN1}	DI = DE = RE = 0V or V _{CC} (Note 18)	Full	-2	-	2	μA	
Input Current (A, B, A/Y, B/Z)	I _{IN2}	DE = 0V, V _{CC} = 0V or 3.6V	V _{IN} = 12V	Full	-	80	125	μA
			V _{IN} = -7V	Full	-100	-50	-	μA
Output Leakage Current (Y, Z) (Full Duplex Versions Only, Note 13)	I _{IN3}	RE = 0V, DE = 0V, V _{CC} = 0V or 3.6V	V _{IN} = 12V	Full	-	10	40	μA
			V _{IN} = -7V	Full	-40	-10	-	μA
Output Leakage Current (Y, Z) in Shutdown Mode (Full Duplex, Note 13)	I _{IN4}	RE = V _{CC} , DE = 0V, V _{CC} = 0V or 3.6V	V _{IN} = 12V	Full	-	10	40	μA
			V _{IN} = -7V	Full	-40	-10	-	μA
Driver Short-Circuit Current, V _O = High or Low	I _{OSD1}	DE = V _{CC} , -7V ≤ V _Y or V _Z ≤ 12V (Note 7)	Full	-	-	±250	mA	
Receiver Differential Threshold Voltage	V _{TH}	-7V ≤ V _{CM} ≤ 12V	Full	-200	-125	-50	mV	
Receiver Input Hysteresis	ΔV _{TH}	V _{CM} = 0V	25	-	15	-	mV	

Electrical Specifications Test Conditions: $V_{CC} = 3.0V$ to $3.6V$; unless otherwise specified. Typicals are at $V_{CC} = 3.3V$, $T_A = +25^{\circ}C$, (Note 5)

PARAMETER	SYMBOL	TEST CONDITIONS	TEMP (°C)	MIN (Note 19)	TYP	MAX (Note 19)	UNITS	
Receiver Output High Voltage	V_{OH}	$I_O = -4mA$, $V_{ID} = -50mV$	Full	$V_{CC} - 0.6$	-	-	V	
Receiver Output Low Voltage	V_{OL}	$I_O = -4mA$, $V_{ID} = -200mV$	Full	-	0.17	0.4	V	
Three-State (high impedance) Receiver Output Current (Note 13)	I_{OZR}	$0.4V \leq V_O \leq 2.4V$	Full	-1	0.015	1	μA	
Receiver Input Resistance	R_{IN}	$-7V \leq V_{CM} \leq 12V$	Full	96	150	-	$k\Omega$	
Receiver Short-Circuit Current	I_{OSR}	$0V \leq V_O \leq V_{CC}$	Full	± 7	30	± 60	mA	
Thermal Shutdown Threshold	T_{SD}		Full	-	150	-	$^{\circ}C$	
SUPPLY CURRENT								
No-Load Supply Current (Note 6)	I_{CC}	$DI = 0V$ or V_{CC}	$DE = V_{CC}$, $RE = 0V$ or V_{CC}	Full	-	510	800	μA
			$DE = 0V$, $RE = 0V$	Full	-	480	700	μA
Shutdown Supply Current (Note 13)	I_{SHDN}	$DE = 0V$, $RE = V_{CC}$, $DI = 0V$ or V_{CC}	Full	-	0.01	12	μA	
ESD PERFORMANCE								
RS-485 Pins (A, Y, B, Z, A/Y, B/Z)		IEC61000-4-2, Air-Gap Discharge Method	25	-	± 15	-	kV	
		IEC61000-4-2, Contact Discharge Method	25	-	± 8	-	kV	
		Human Body Model, from bus pins to GND	25	-	± 15	-	kV	
All Pins		HBM, per MIL-STD-883 Method 3015	25	-	± 7	-	kV	
		Machine Model	25	-	200	-	V	
DRIVER SWITCHING CHARACTERISTICS (ISL3170E, ISL3171E, ISL3172E, 250kbps)								
Maximum Data Rate	f_{MAX}	$V_{OD} = \pm 1.5V$, $C_D = 820pF$ (Figure 7, Note 17)	Full	250	800	-	kbps	
Driver Differential Output Delay	t_{DD}	$R_{DIFF} = 54\Omega$, $C_D = 50pF$ (Figure 5)	Full	250	1100	1500	ns	
Driver Differential Output Skew	t_{SKEW}	$R_{DIFF} = 54\Omega$, $C_D = 50pF$ (Figure 5)	Full	-	6	100	ns	
Driver Differential Rise or Fall Time	t_R , t_F	$R_{DIFF} = 54\Omega$, $C_D = 50pF$ (Figure 5)	Full	350	960	1600	ns	
Driver Enable to Output High	t_{ZH}	$R_L = 500\Omega$, $C_L = 50pF$, SW = GND (Figure 6, Notes 8, 13)	Full	-	26	600	ns	
Driver Enable to Output Low	t_{ZL}	$R_L = 500\Omega$, $C_L = 50pF$, SW = V_{CC} (Figure 6, Notes 8, 13)	Full	-	200	600	ns	
Driver Disable from Output High	t_{HZ}	$R_L = 500\Omega$, $C_L = 50pF$, SW = GND (Figure 6, Note 13)	Full	-	28	55	ns	
Driver Disable from Output Low	t_{LZ}	$R_L = 500\Omega$, $C_L = 50pF$, SW = V_{CC} (Figure 6, Note 13)	Full	-	30	55	ns	
Time to Shutdown	t_{SHDN}	(Notes 10, 13)	Full	50	200	600	ns	
Driver Enable from Shutdown to Output High	$t_{ZH(SHDN)}$	$R_L = 500\Omega$, $C_L = 50pF$, SW = GND (Figure 6, Notes 10, 11, 13)	Full	-	180	700	ns	
Driver Enable from Shutdown to Output Low	$t_{ZL(SHDN)}$	$R_L = 500\Omega$, $C_L = 50pF$, SW = V_{CC} (Figure 6, Notes 10, 11, 13)	Full	-	100	700	ns	
DRIVER SWITCHING CHARACTERISTICS (ISL3173E, ISL3174E, ISL3175E, 500kbps)								
Maximum Data Rate	f_{MAX}	$V_{OD} = \pm 1.5V$, $C_D = 820pF$ (Figure 7, Note 17)	Full	500	1600	-	kbps	
Driver Differential Output Delay	t_{DD}	$R_{DIFF} = 54\Omega$, $C_D = 50pF$ (Figure 5)	Full	180	350	800	ns	
Driver Differential Output Skew	t_{SKEW}	$R_{DIFF} = 54\Omega$, $C_D = 50pF$ (Figure 5)	Full	-	1	30	ns	
Driver Differential Rise or Fall Time	t_R , t_F	$R_{DIFF} = 54\Omega$, $C_D = 50pF$ (Figure 5)	Full	200	380	800	ns	
Driver Enable to Output High	t_{ZH}	$R_L = 500\Omega$, $C_L = 50pF$, SW = GND (Figure 6, Notes 8, 13)	Full	-	26	350	ns	

Electrical Specifications Test Conditions: $V_{CC} = 3.0V$ to $3.6V$; unless otherwise specified. Typical values are at $V_{CC} = 3.3V$, $T_A = +25^\circ C$, (Note 5)

PARAMETER	SYMBOL	TEST CONDITIONS	TEMP (°C)	MIN (Note 19)	TYP	MAX (Note 19)	UNITS	
Driver Enable to Output Low	t_{ZL}	$R_L = 500\Omega$, $C_L = 50pF$, SW = V_{CC} (Figure 6, Notes 8, 13)	Full	-	100	350	ns	
Driver Disable from Output High	t_{HZ}	$R_L = 500\Omega$, $C_L = 50pF$, SW = GND (Figure 6, Note 13)	Full	-	28	55	ns	
Driver Disable from Output Low	t_{LZ}	$R_L = 500\Omega$, $C_L = 50pF$, SW = V_{CC} (Figure 6, Note 13)	Full	-	30	55	ns	
Time to Shutdown	t_{SHDN}	(Notes 10, 13)	Full	50	200	600	ns	
Driver Enable from Shutdown to Output High	$t_{ZH(SHDN)}$	$R_L = 500\Omega$, $C_L = 50pF$, SW = GND (Figure 6, Notes 10, 11, 13)	Full	-	180	700	ns	
Driver Enable from Shutdown to Output Low	$t_{ZL(SHDN)}$	$R_L = 500\Omega$, $C_L = 50pF$, SW = V_{CC} (Figure 6, Notes 10, 11, 13)	Full	-	100	700	ns	
DRIVER SWITCHING CHARACTERISTICS (ISL3176E, ISL3177E, ISL3178E, 20Mbps)								
Maximum Data Rate	f_{MAX}	$V_{OD} = \pm 1.5V$, $C_D = 350pF$ (Figure 7, Note 17)	Full	20	28	-	Mbps	
Driver Differential Output Delay	t_{DD}	$R_{DIFF} = 54\Omega$, $C_D = 50pF$ (Figure 5)	Full	-	27	40	ns	
Driver Differential Output Skew	t_{SKEW}	$R_{DIFF} = 54\Omega$, $C_D = 50pF$ (Figure 5)	Full	-	1	3	ns	
Driver Output Skew, Part-to-Part	Δt_{DSKEW}	$R_{DIFF} = 54\Omega$, $C_D = 50pF$ (Figure 5, Note 14)	Full	-	-	11	ns	
Driver Differential Rise or Fall Time	t_R, t_F	$R_{DIFF} = 54\Omega$, $C_D = 50pF$ (Figure 5)	Full	-	9	15	ns	
Driver Enable to Output High	t_{ZH}	$R_L = 500\Omega$, $C_L = 50pF$, SW = GND (Figure 6, Notes 8, 13)	Full	-	17	50	ns	
Driver Enable to Output Low	t_{ZL}	$R_L = 500\Omega$, $C_L = 50pF$, SW = V_{CC} (Figure 6, Notes 8, 13)	Full	-	16	40	ns	
Driver Disable from Output High	t_{HZ}	$R_L = 500\Omega$, $C_L = 50pF$, SW = GND (Figure 6, Note 13)	Full	-	25	40	ns	
Driver Disable from Output Low	t_{LZ}	$R_L = 500\Omega$, $C_L = 50pF$, SW = V_{CC} (Figure 6, Note 13)	Full	-	28	50	ns	
Time to Shutdown	t_{SHDN}	(Notes 10, 13)	Full	50	200	600	ns	
Driver Enable from Shutdown to Output High	$t_{ZH(SHDN)}$	$R_L = 500\Omega$, $C_L = 50pF$, SW = GND (Figure 6, Notes 10, 11, 13)	Full	-	180	700	ns	
Driver Enable from Shutdown to Output Low	$t_{ZL(SHDN)}$	$R_L = 500\Omega$, $C_L = 50pF$, SW = V_{CC} (Figure 6, Notes 10, 11, 13)	Full	-	90	700	ns	
RECEIVER SWITCHING CHARACTERISTICS (All Versions)								
Maximum Data Rate	f_{MAX}	$V_{ID} = \pm 1.5V$ (Note 17)	ISL3170E-75E	Full	12	20	-	Mbps
			ISL3176E-78E	Full	20	35	-	Mbps
Receiver Input to Output Delay	t_{PLH}, t_{PHL}	(Figure 8)	ISL3170E-75E	Full	25	70	120	ns
			ISL3176E-78E	Full	25	33	60	ns
Receiver Skew $t_{PLH} - t_{PHL}$	t_{SKD}	(Figure 8)		Full	-	1.5	4	ns
Receiver Skew, Part-to-Part	Δt_{RSKEW}	(Figure 8, Note 14)		Full	-	-	15	ns
Receiver Enable to Output High	t_{ZH}	$R_L = 1k\Omega$, $C_L = 15pF$, SW = GND (Figure 9, Notes 9, 13)	ISL3170E-75E	Full	5	15	20	ns
			ISL3176E-78E	Full	5	11	17	ns
Receiver Enable to Output Low	t_{ZL}	$R_L = 1k\Omega$, $C_L = 15pF$, SW = V_{CC} (Figure 9, Notes 9, 13)	ISL3170E-75E	Full	5	15	20	ns
			ISL3176E-78E	Full	5	11	17	ns

Electrical Specifications Test Conditions: $V_{CC} = 3.0V$ to $3.6V$; unless otherwise specified. Typicals are at $V_{CC} = 3.3V$, $T_A = +25^{\circ}C$, (Note 5)

PARAMETER	SYMBOL	TEST CONDITIONS	TEMP (°C)	MIN (Note 19)	TYP	MAX (Note 19)	UNITS	
Receiver Disable from Output High	t_{HZ}	$R_L = 1k\Omega$, $C_L = 15pF$, SW = GND (Figure 9, Note 13)	ISL3170E-75E	Full	5	12	20	ns
			ISL3176E-78E	Full	4	7	15	ns
Receiver Disable from Output Low	t_{LZ}	$R_L = 1k\Omega$, $C_L = 15pF$, SW = V_{CC} (Figure 9, Note 13)	ISL3170E-75E	Full	5	13	20	ns
			ISL3176E-78E	Full	4	7	15	ns
Time to Shutdown	t_{SHDN}	(Notes 10, 13)	Full	50	180	600	ns	
Receiver Enable from Shutdown to Output High	$t_{ZH}(SHDN)$	$R_L = 1k\Omega$, $C_L = 15pF$, SW = GND (Figure 9, Notes 10, 12, 13)	Full	-	240	500	ns	
Receiver Enable from Shutdown to Output Low	$t_{ZL}(SHDN)$	$R_L = 1k\Omega$, $C_L = 15pF$, SW = V_{CC} (Figure 9, Notes 10, 12, 13)	Full	-	240	500	ns	

NOTES:

- All currents into device pins are positive; all currents out of device pins are negative. All voltages are referenced to device ground unless otherwise specified.
- Supply current specification is valid for loaded drivers when DE = 0V.
- Applies to peak current. See "Typical Performance Curves" starting on page 15 for more information.
- When testing devices with the shutdown feature, keep $\overline{RE} = 0$ to prevent the device from entering SHDN.
- When testing devices with the shutdown feature, the \overline{RE} signal high time must be short enough (typically <100ns) to prevent the device from entering SHDN.
- Versions with a shutdown feature are put into shutdown by bringing \overline{RE} high and DE low. If the inputs are in this state for less than 50ns, the parts are ensured not to enter shutdown. If the inputs are in this state for at least 600ns, the parts are ensured to have entered shutdown. See "Low Power Shutdown Mode" on page 14.
- Keep $\overline{RE} = V_{CC}$, and set the DE signal low time >600ns to ensure that the device enters SHDN.
- Set the \overline{RE} signal high time >600ns to ensure that the device enters SHDN.
- Does not apply to the ISL3171E, ISL3174E, or ISL3177E.
- Δt_{SKEW} is the magnitude of the difference in propagation delays of the specified terminals of two units tested with identical test conditions (V_{CC} , temperature, etc.). Applies only to the ISL3176E through ISL3178E.
- ISL3170E through ISL3175E only.
- $V_{CC} \geq 3.15V$.
- Limits established by characterization and are not production tested.
- If the Tx or Rx enable function is not needed, connect the enable pin to the appropriate supply (see "Pin Descriptions" on page 5) through a 1k Ω to 3k Ω resistor.
- Parameters with MIN and/or MAX limits are 100% tested at +25°C, unless otherwise specified. Temperature limits established by characterization and are not production tested.
- If the DE or \overline{RE} input voltage exceeds the V_{CC} voltage by more than 500mV, then current will flow into the logic pin. The current is limited by a 340 Ω resistor (so $\approx 13mA$ with $V_{IN} = 5V$ and $V_{CC} = 0V$) so no damage will occur if $V_{CC} \leq V_{IN} \leq 7V$ for short periods of time.

Test Circuits and Waveforms

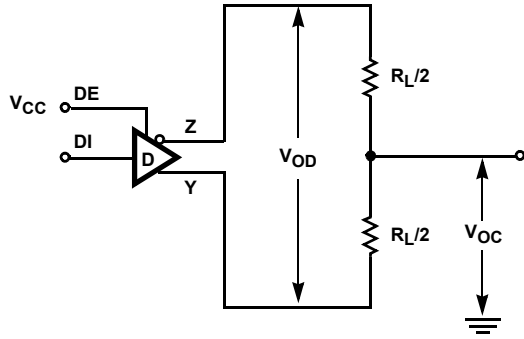

FIGURE 4A. V_{OD} AND V_{OC}

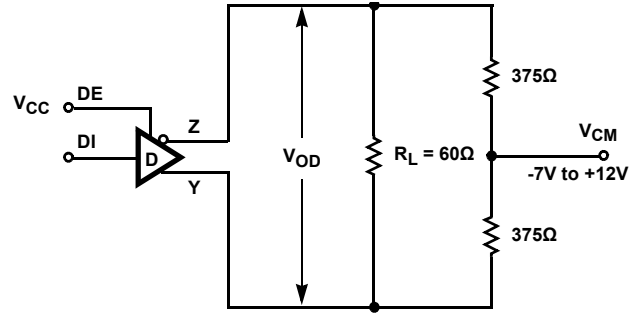

FIGURE 4B. V_{OD} WITH COMMON MODE LOAD

FIGURE 4. DC DRIVER TEST CIRCUITS

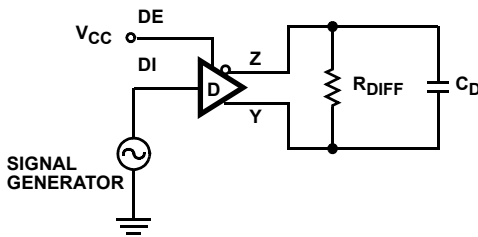

FIGURE 5A. TEST CIRCUIT

FIGURE 5. DRIVER PROPAGATION DELAY AND DIFFERENTIAL TRANSITION TIMES

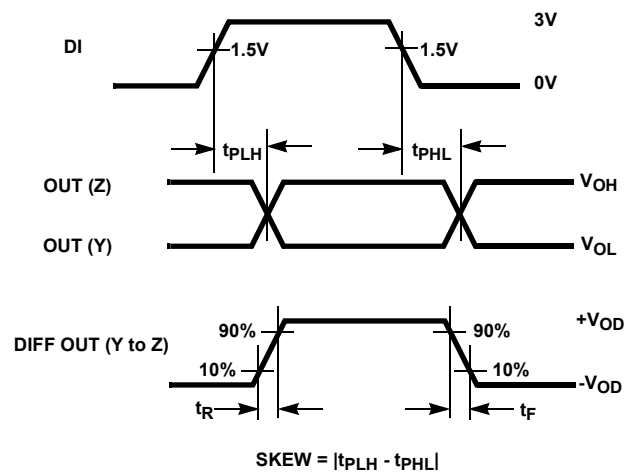

FIGURE 5B. MEASUREMENT POINTS

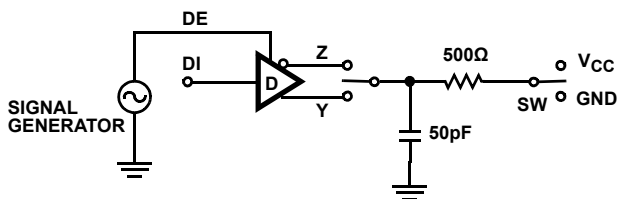

FIGURE 6A. TEST CIRCUIT

FIGURE 6. DRIVER ENABLE AND DISABLE TIMES (EXCEPT ISL3171E, ISL3174E, ISL3177E)

PARAMETER	OUTPUT	RE	DI	SW
t_{HZ}	Y/Z	X	1/0	GND
t_{LZ}	Y/Z	X	0/1	V_{CC}
t_{ZH}	Y/Z	0 (Note 8)	1/0	GND
t_{ZL}	Y/Z	0 (Note 8)	0/1	V_{CC}
$t_{ZH}(SHDN)$	Y/Z	1 (Note 11)	1/0	GND
$t_{ZL}(SHDN)$	Y/Z	1 (Note 11)	0/1	V_{CC}

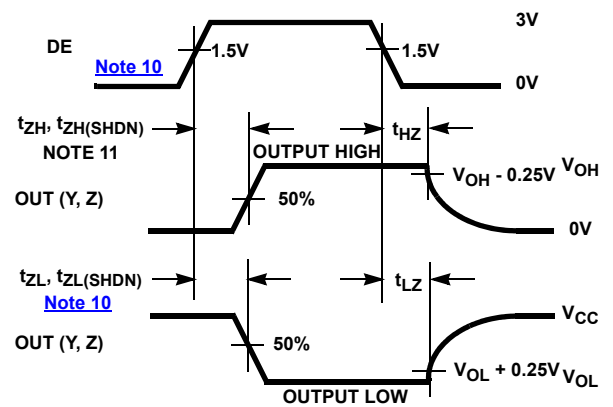

FIGURE 6B. MEASUREMENT POINTS

Test Circuits and Waveforms (Continued)

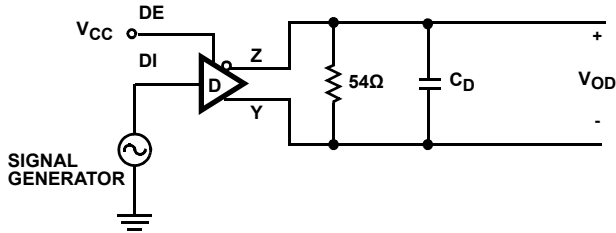

FIGURE 7A. TEST CIRCUIT

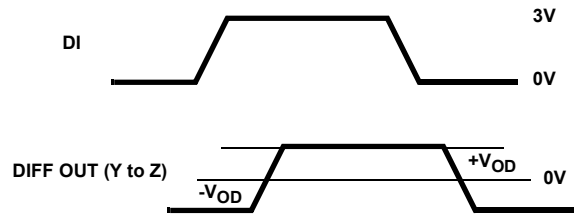

FIGURE 7B. MEASUREMENT POINTS

FIGURE 7. DRIVER DATA RATE

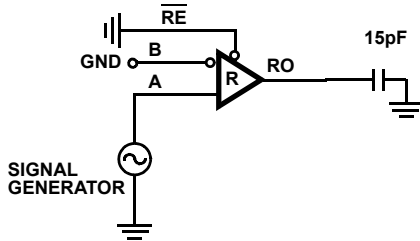

FIGURE 8A. TEST CIRCUIT

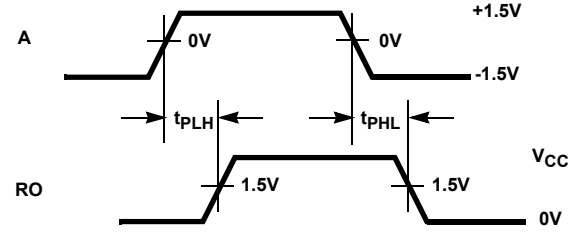

FIGURE 8B. MEASUREMENT POINTS

FIGURE 8. RECEIVER PROPAGATION DELAY

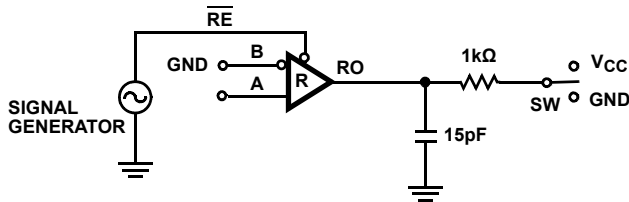

FIGURE 9A. TEST CIRCUIT

PARAMETER	DE	A	SW
t_{HZ}	X	+1.5V	GND
t_{LZ}	X	-1.5V	V_{CC}
t_{ZH} (Note 9)	0	+1.5V	GND
t_{ZL} (Note 9)	0	-1.5V	V_{CC}
$t_{ZH(SHDN)}$ (Note 12)	0	+1.5V	GND
$t_{ZL(SHDN)}$ (Note 12)	0	-1.5V	V_{CC}

FIGURE 9. RECEIVER ENABLE AND DISABLE TIMES (EXCEPT ISL3171E, ISL3174E, ISL3177E)

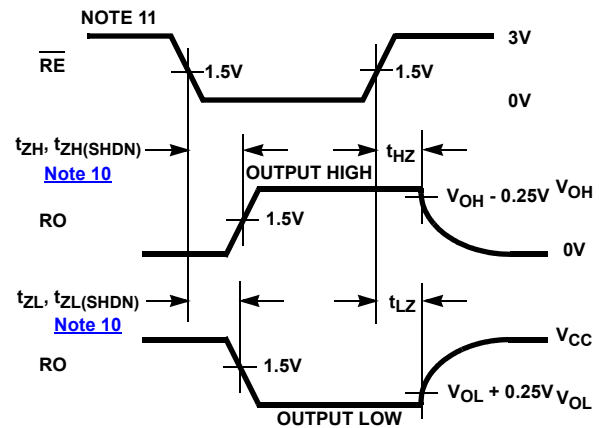

FIGURE 9B. MEASUREMENT POINTS

Application Information

RS-485 and RS-422 are differential (balanced) data transmission standards for use in long haul or noisy environments. RS-422 is a subset of RS-485, so RS-485 transceivers are also RS-422 compliant. RS-422 is a point-to-multipoint (multidrop) standard, which allows only one driver and up to 10 receivers on each bus, assuming one unit load devices. RS-485 is a true multipoint standard, which allows up to 32 one-unit load devices (any combination of drivers and receivers) on each bus. To allow for multipoint operation, the RS-485 specification requires that drivers must handle bus contention without sustaining any damage.

Another important advantage of RS-485 is the extended common-mode range (CMR), which specifies that the driver outputs and receiver inputs withstand signals that range from +12V to -7V. RS-422 and RS-485 are intended for runs as long as 4000ft, so the wide CMR is necessary to handle ground potential differences, as well as voltages induced in the cable by external fields.

Receiver Features

These devices utilize a differential input receiver for maximum noise immunity and common mode rejection. Input sensitivity is better than $\pm 200\text{mV}$, as required by the RS-422 and RS-485 specifications.

Receiver input resistance of $96\text{k}\Omega$ surpasses the RS-422 specification of $4\text{k}\Omega$ and is eight times the RS-485 "Unit Load (UL)" requirement of $12\text{k}\Omega$ minimum. Thus, these products are known as "one-eighth UL" transceivers and there can be up to 256 of these devices on a network while still complying with the RS-485 loading specification.

Receiver inputs function with common-mode voltages as great as +9V/-7V outside the power supplies (that is, +12V and -7V), making them ideal for long networks where induced voltages and ground potential differences are realistic concerns.

All the receivers include a "Full Fail-Safe" function that guarantees a high level receiver output if the receiver inputs are unconnected (floating) or shorted. Fail-safe with shorted inputs is achieved by setting the Rx upper switching point to -50mV, thereby ensuring that the Rx sees 0V differential as a high input level.

Receivers easily meet the data rates supported by the corresponding driver, and all receiver outputs (except on the ISL3171E, ISL3174E, and ISL3177E) are tri-statable using the active low $\overline{\text{RE}}$ input.

Driver Features

The RS-485/422 driver is a differential output device that delivers at least 1.5V across a 54Ω load (RS-485) and at least 2V across a 100Ω load (RS-422). The drivers feature low propagation delay skew to maximize bit width and to minimize EMI.

All drivers are tri-statable through the active high DE input, except on the ISL3171E, ISL3174E, and ISL3177E.

The 250kbps and 500kbps driver outputs are slew rate limited to minimize EMI and to reduce reflections in unterminated or improperly terminated networks. Outputs of the ISL3176E through ISL3178E drivers are not limited, so faster output transition times allow data rates of at least 20Mbps.

Hot Plug Function

When a piece of equipment powers up, a period of time occurs in which the processor or ASIC driving the RS-485 control lines (DE, $\overline{\text{RE}}$) is unable to ensure that the RS-485 Tx and Rx outputs are kept disabled. If the equipment is connected to the bus, a driver activating prematurely during power up may crash the bus. To avoid this scenario, the ISL317XE versions with output enable pins incorporate a "Hot Plug" function. During power up, circuitry monitoring V_{CC} ensures that the Tx and Rx outputs remain disabled for a period of time, regardless of the state of DE and $\overline{\text{RE}}$. This gives the processor/ASIC a chance to stabilize and drive the RS-485 control lines to the proper states.

ESD Protection

All pins on these devices include Class 3 (>7kV) Human Body Model (HBM) ESD protection structures, but the RS-485 pins (driver outputs and receiver inputs) incorporate advanced structures allowing them to survive ESD events in excess of $\pm 15\text{kV}$ HBM and $\pm 15\text{kV}$ IEC61000. The RS-485 pins are particularly vulnerable to ESD damage because they typically connect to an exposed port on the exterior of the finished product. Simply touching the port pins, or connecting a cable, can cause an ESD event that might destroy unprotected ICs. These new ESD structures protect the device whether or not it is powered up, and without degrading the RS-485 common mode range of -7V to +12V. This built-in ESD protection eliminates the need for board level protection structures (for example, transient suppression diodes), and the associated, undesirable capacitive load they present.

IEC61000-4-2 Testing

The IEC61000 test method applies to finished equipment, rather than to an individual IC. Therefore, the pins most likely to suffer an ESD event are those that are exposed to the outside world (the RS-485 pins in this case), and the IC is tested in its typical application configuration (power applied) rather than testing each pin-to-pin combination. The lower current limiting resistor coupled with the larger charge storage capacitor yields a test that is much more severe than the HBM test. The extra ESD protection built into this device's RS-485 pins allows the design of equipment meeting Level 4 criteria without the need for additional board level protection on the RS-485 port.

AIR-GAP DISCHARGE TEST METHOD

For this test method, a charged probe tip moves toward the IC pin until the voltage arcs to it. The current waveform delivered to the IC pin depends on approach speed, humidity, temperature, etc., so it is difficult to obtain repeatable results. The ISL317XE RS-485 pins withstand $\pm 15\text{kV}$ air-gap discharges.

CONTACT DISCHARGE TEST METHOD

During the contact discharge test, the probe contacts the tested pin before the probe tip is energized, thereby eliminating the variables associated with the air-gap discharge. The result is a more repeatable and predictable test, but equipment limits prevent testing devices at voltages higher than $\pm 8\text{kV}$. The ISL317XE survive $\pm 8\text{kV}$ contact discharges on the RS-485 pins.

Data Rate, Cables, and Terminations

RS-485/422 are intended for network lengths up to 4000ft, but the maximum system data rate decreases as the transmission length increases. Devices operating at 20Mbps are limited to lengths less than 100ft, while the 250kbps versions can operate at full data rates with lengths of several thousand feet.

Twisted pair is the cable of choice for RS-485/422 networks. Twisted pair cables tend to pick up noise and other electromagnetically induced voltages as common mode signals, which are effectively rejected by the differential receivers in these ICs.

Proper termination is imperative when using the 20Mbps devices to minimize reflections. Short networks using the 250kbps versions do not need to be terminated, but terminations are recommended unless power dissipation is an overriding concern.

In point-to-point, or point-to-multipoint (single driver on bus) networks, the main cable should be terminated in its characteristic impedance (typically 120Ω) at the end farthest from the driver. In multi-receiver applications, keep stubs connecting receivers to the main cable as short as possible. Multipoint (multi-driver) systems require that the main cable be terminated in its characteristic impedance at both ends. Keep stubs connecting a transceiver to the main cable as short as possible.

Built-In Driver Overload Protection

As stated previously, the RS-485 spec requires that drivers survive worst case bus contentions undamaged. These devices meet this requirement via driver output short circuit current limits, and on-chip thermal shutdown circuitry.

The driver output stages incorporate short circuit current limiting circuitry which ensures that the output current never exceeds the RS-485 spec, even at the common-mode voltage range extremes. Additionally, these devices utilize a foldback circuit which reduces the short circuit current, and thus the power dissipation, whenever the contending voltage exceeds either supply.

In the event of a major short circuit condition, devices use a thermal shutdown feature that disables the drivers whenever the die temperature becomes excessive. This eliminates the power dissipation, allowing the die to cool. The drivers automatically re-enable after the die temperature drops about 15° . If the contention persists, the thermal shutdown/re-enable cycle repeats until the fault is cleared. Receivers stay operational during thermal shutdown.

Low Power Shutdown Mode

These CMOS transceivers all use a fraction of the power required by their bipolar counterparts, but some also include a shutdown feature that reduces the already low quiescent I_{CC} to a 10nA trickle. These devices enter shutdown whenever the receiver and driver are *simultaneously* disabled ($\overline{RE} = V_{CC}$ and $DE = GND$) for a period of at least 600ns. Disabling both the driver and the receiver for less than 50ns guarantees that the transceiver will not enter shutdown.

Note that receiver and driver enable times increase when the transceiver enables from shutdown. Refer to [Notes 8](#) through [12](#) at the end of the "Electrical Specifications table" on [page 10](#), for more information.

Typical Performance Curves $V_{CC} = 3.3V$, $T_A = +25^\circ C$, unless otherwise specified

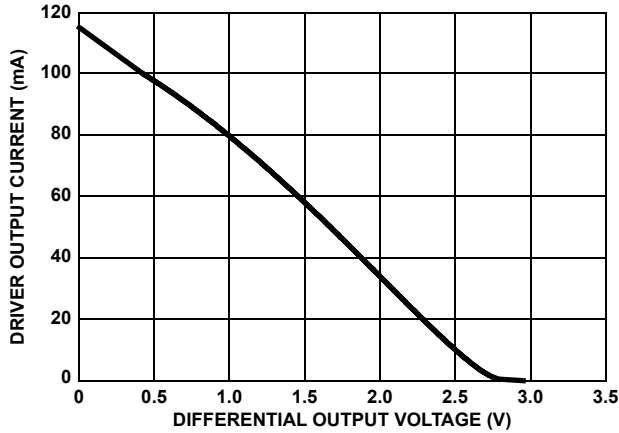

FIGURE 10. DRIVER OUTPUT CURRENT vs DIFFERENTIAL OUTPUT VOLTAGE

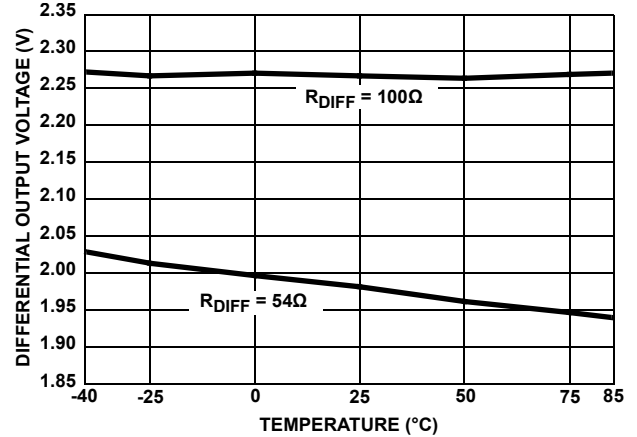

FIGURE 11. DRIVER DIFFERENTIAL OUTPUT VOLTAGE vs TEMPERATURE

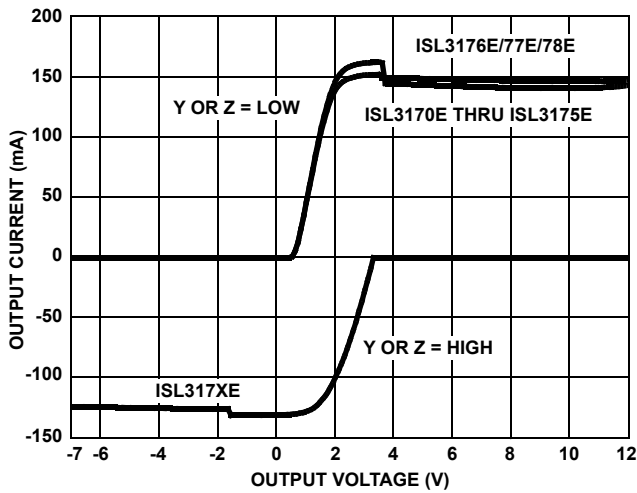

FIGURE 12. DRIVER OUTPUT CURRENT vs SHORT CIRCUIT VOLTAGE

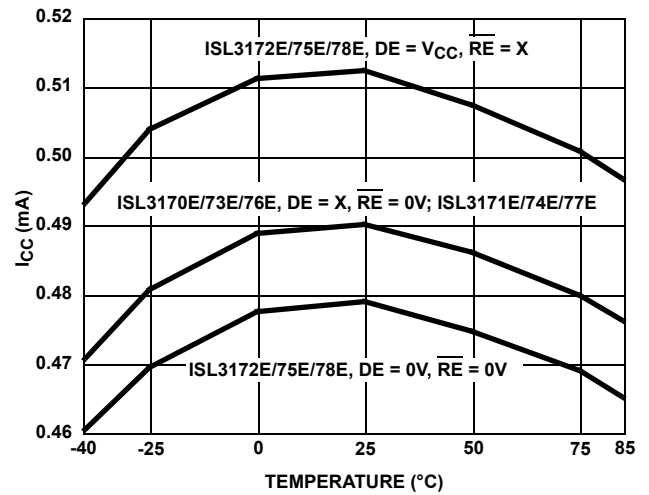

FIGURE 13. SUPPLY CURRENT vs TEMPERATURE

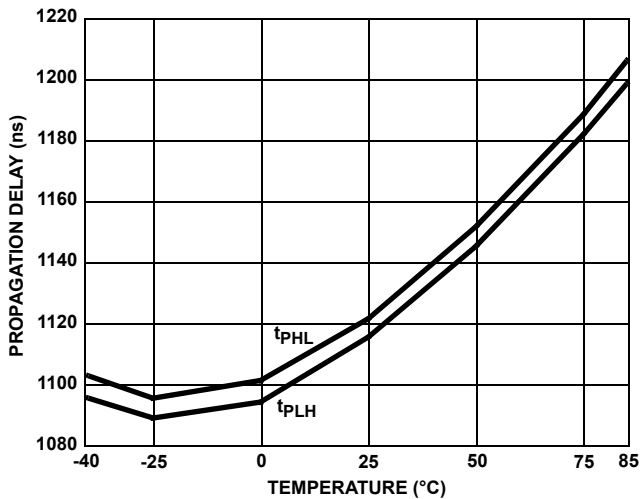

FIGURE 14. DRIVER DIFFERENTIAL PROPAGATION DELAY vs TEMPERATURE (ISL3170E, ISL3171E, ISL3172E)

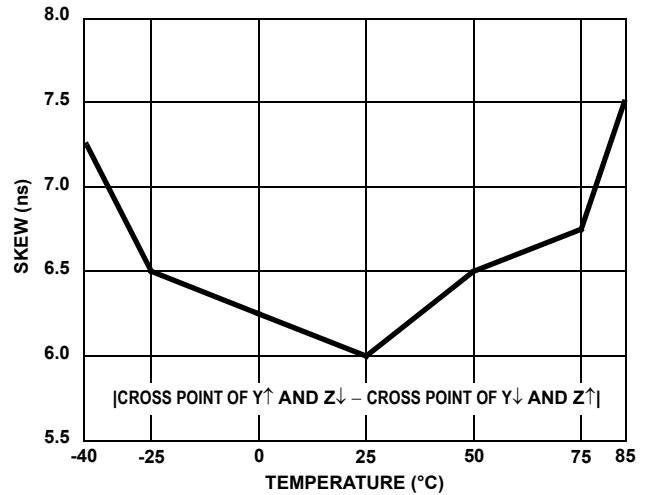

FIGURE 15. DRIVER DIFFERENTIAL SKEW vs TEMPERATURE (ISL3170E, ISL3171E, ISL3172E)

Typical Performance Curves $V_{CC} = 3.3V$, $T_A = +25^\circ C$, unless otherwise specified (Continued)

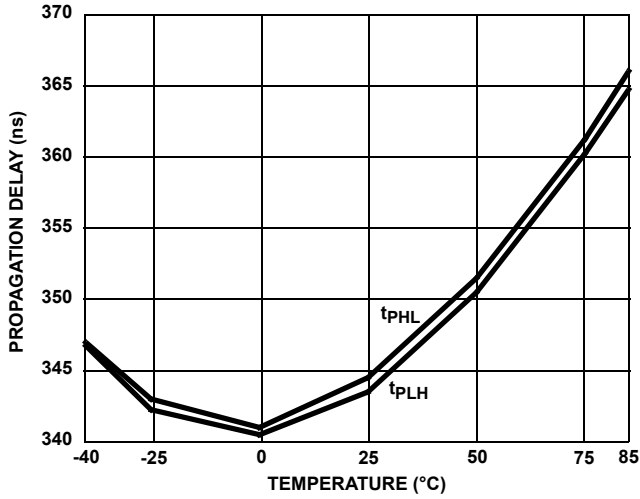

FIGURE 16. DRIVER DIFFERENTIAL PROPAGATION DELAY vs TEMPERATURE (ISL3173E, ISL3174E, ISL3175E)

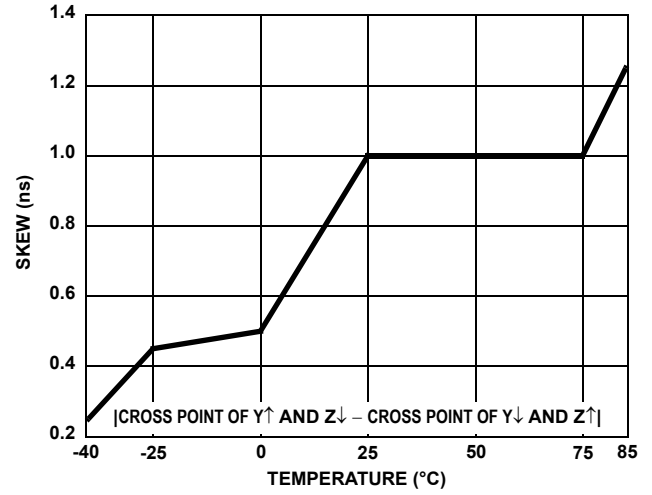

FIGURE 17. DRIVER DIFFERENTIAL SKEW vs TEMPERATURE (ISL3173E, ISL3174E, ISL3175E)

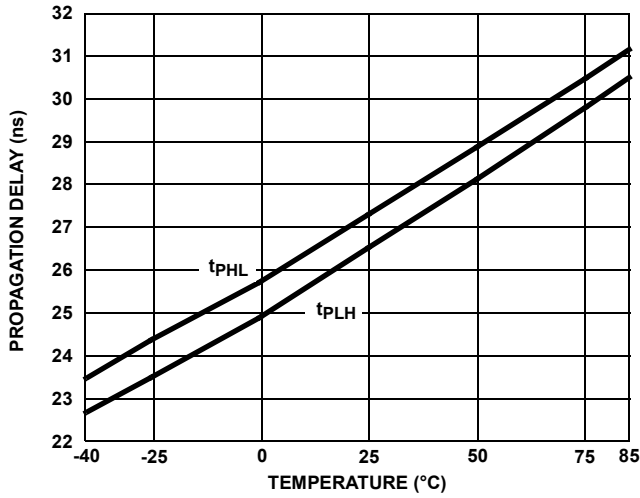

FIGURE 18. DRIVER DIFFERENTIAL PROPAGATION DELAY vs TEMPERATURE (ISL3176E, ISL3177E, ISL3178E)

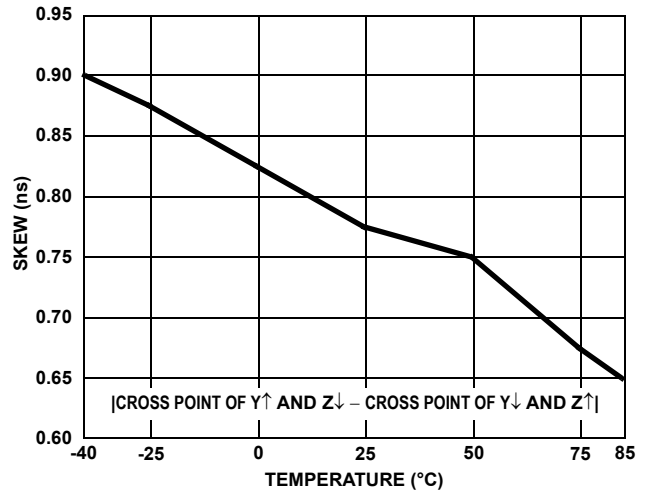

FIGURE 19. DRIVER DIFFERENTIAL SKEW vs TEMPERATURE (ISL3176E, ISL3177E, ISL3178E)

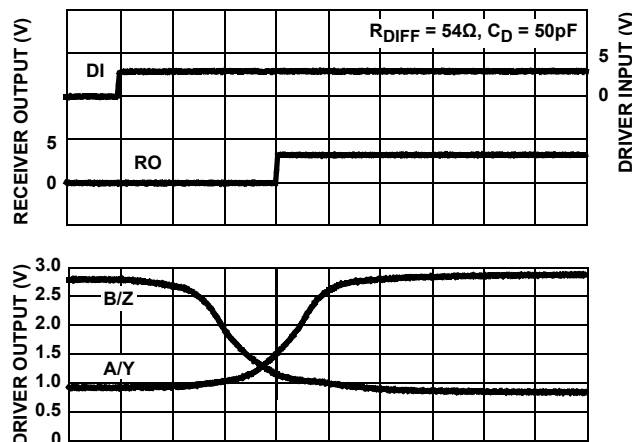

FIGURE 20. DRIVER AND RECEIVER WAVEFORMS, LOW TO HIGH (ISL3170E, ISL3171E, ISL3172E)

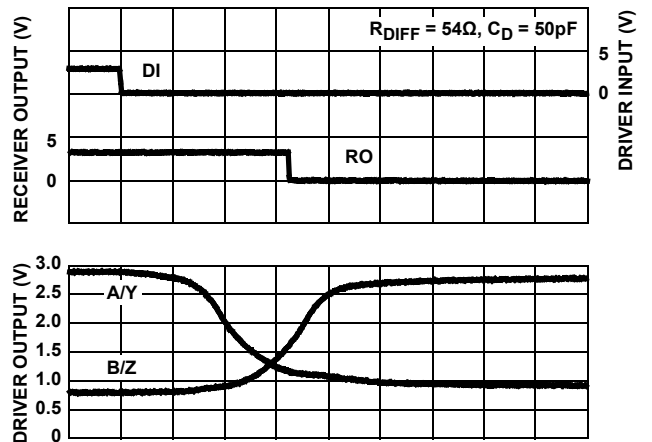

FIGURE 21. DRIVER AND RECEIVER WAVEFORMS, HIGH TO LOW (ISL3170E, ISL3171E, ISL3172E)

Typical Performance Curves $V_{CC} = 3.3V$, $T_A = +25^\circ C$, unless otherwise specified (Continued)

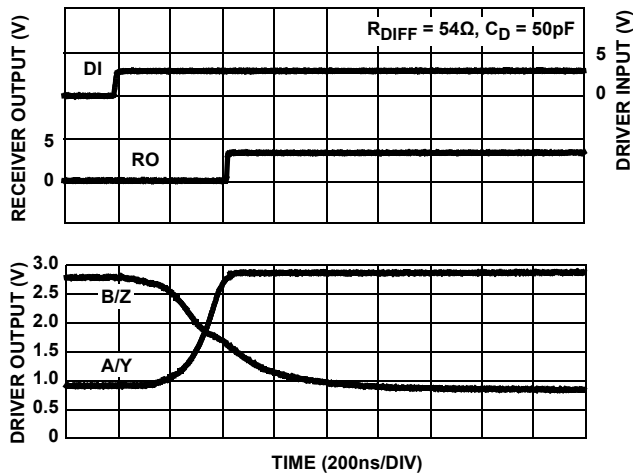

FIGURE 22. DRIVER AND RECEIVER WAVEFORMS, LOW TO HIGH (ISL3173E, ISL3174E, ISL3175E)

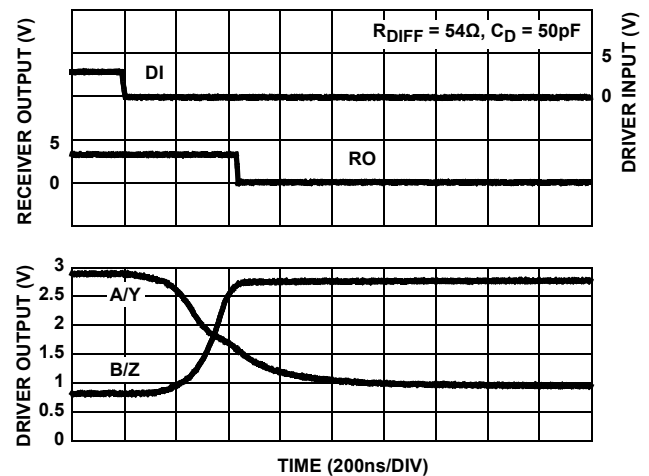

FIGURE 23. DRIVER AND RECEIVER WAVEFORMS, HIGH TO LOW (ISL3173E, ISL3174E, ISL3175E)

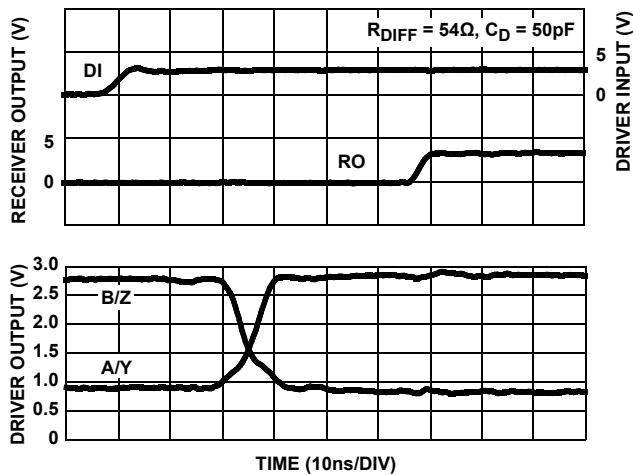

FIGURE 24. DRIVER AND RECEIVER WAVEFORMS, LOW TO HIGH (ISL3176E, ISL3177E, ISL3178E)

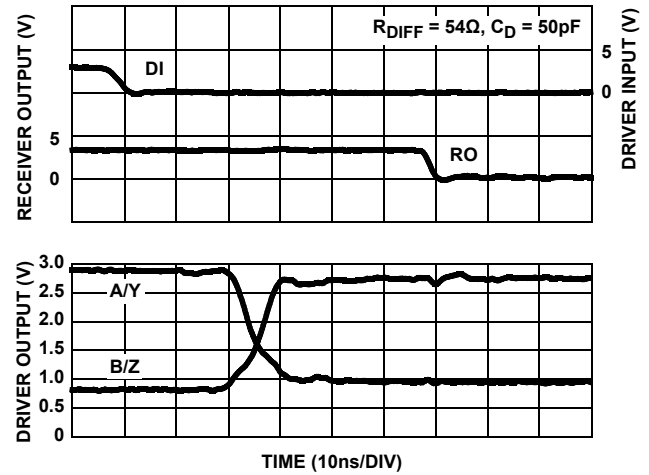

FIGURE 25. DRIVER AND RECEIVER WAVEFORMS, HIGH TO LOW (ISL3176E, ISL3177E, ISL3178E)

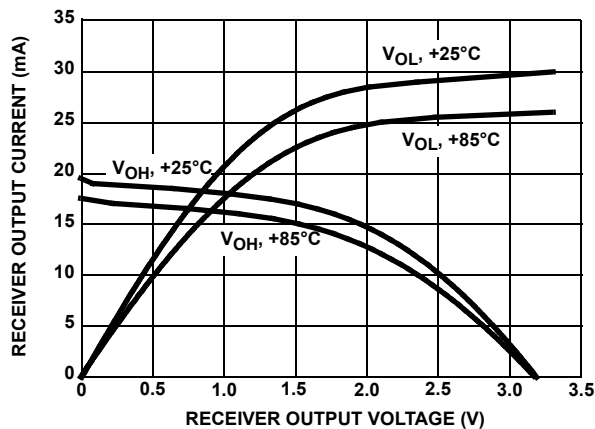

FIGURE 26. RECEIVER OUTPUT CURRENT vs RECEIVER OUTPUT VOLTAGE

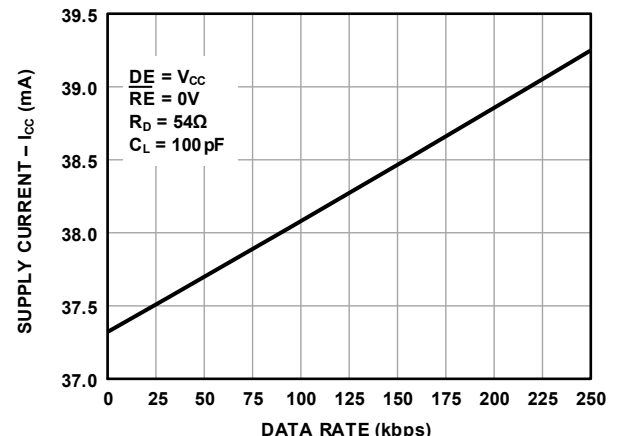

FIGURE 27. SUPPLY CURRENT vs DATA RATE (ISL3170E, ISL3172E)

Typical Performance Curves $V_{CC} = 3.3V$, $T_A = +25^{\circ}C$, unless otherwise specified (Continued)

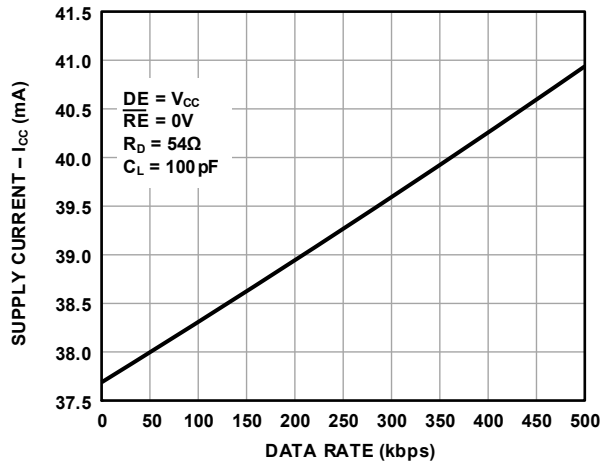

FIGURE 28. SUPPLY CURRENT vs DATA RATE (ISL3173E, ISL3175E)

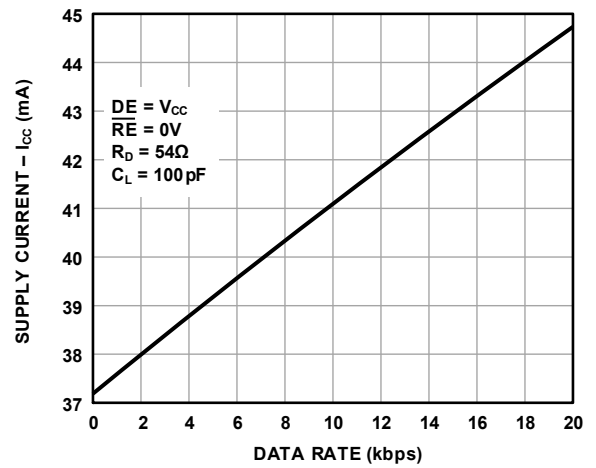

FIGURE 29. SUPPLY CURRENT vs DATA RATE (ISL3176E, ISL3178E)

Die Characteristics

SUBSTRATE POTENTIAL (POWERED UP):

GND

TRANSISTOR COUNT:

535

PROCESS:

Si Gate BiCMOS

Revision History

The revision history provided is for informational purposes only and is believed to be accurate, but not warranted. Please visit our website to make sure you have the latest revision.

REVISION	DATE	CHANGE
6.05	Sep 29, 2023	Updated POD M8.15 to the latest version (corrected typo).
6.04	Jul 11, 2023	Removed High EFT information throughout.
6.03	Feb 16, 2023	Added EFT features bullet. Added High EFT Immunity section.
6.02	Jul 7, 2022	Removed related literature section. Updated links throughout. Updated ordering information table format. Removed Note 2. Added Figures 27, 28, and 29. Updated POD M8.118 to the latest version, changes are as follows: -Corrected typo in the side view 1 updating package thickness tolerance from ± 0.10 to ± 0.10 . Updated POD M8.15 to the latest version, changes are as follows: -Added the coplanarity spec into the drawing. Updated POD M10.118 to the latest version, changes are as follows: -Corrected typo in the side view 1 updating package thickness tolerance from ± 0.10 to ± 0.10 . Updated POD M14.15 to the latest version, changes are as follows: -In Side View B and Detail A: Added lead length dimension (1.27 – 0.40) Changed angle of the lead to 0-8 degrees.
6.01	Nov 7, 2019	Changed (+125mA/-100mA) to (+125 μ A/-100 μ A) in the first paragraph on page 1. Removed About Intersil section. Updated disclaimer
6.00	Aug 31, 2017	Applied new header/footer. Added Related Literature on page 1. Added Note 2 to Ordering Information table on page 2. Updated the Receiving Truth table on page 4. Updated POD M10.118 on page 20 from rev 0 to rev 1. Changes: Updated to new POD template. Added land pattern Added Revision History and About Intersil sections.

Package Outline Drawings

For the most recent package outline drawing, see [M8.118](#).

M8.118
 8 Lead Mini Small Outline Plastic Package
 Rev 5, 5/2021

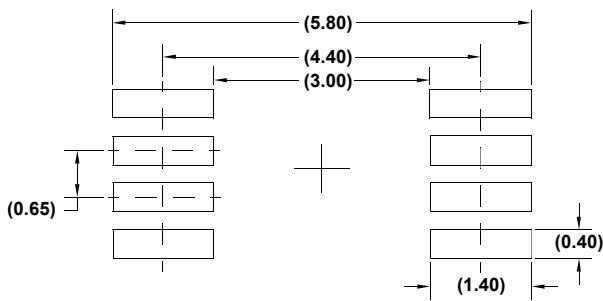
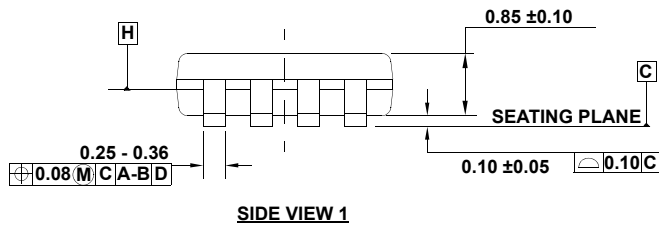
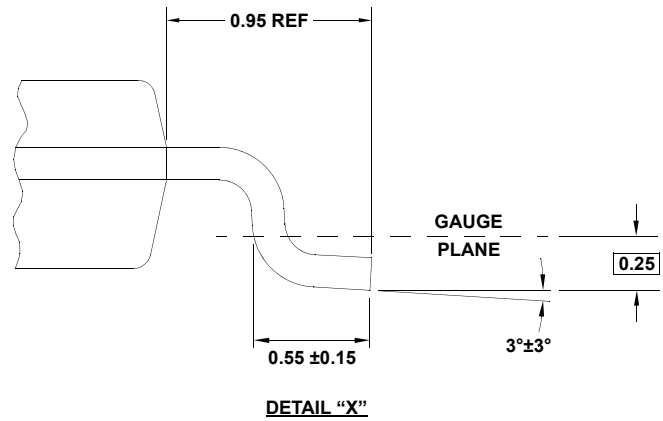
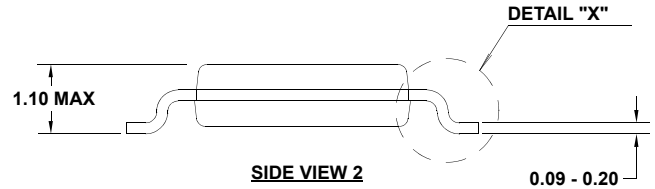
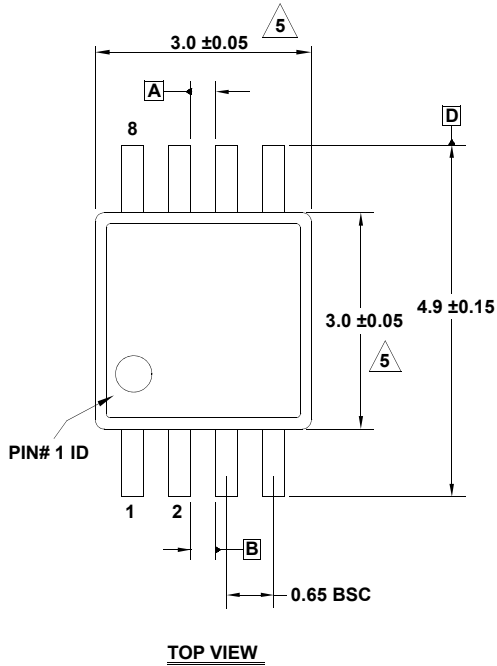

NOTES:

1. Dimensions are in millimeters.
2. Dimensioning and tolerancing conform to JEDEC MO-187-AA and AMSEY14.5m-1994.
3. Plastic or metal protrusions of 0.15mm max per side are not included.
4. Plastic interlead protrusions of 0.15mm max per side are not included.

5. Dimensions are measured at Datum Plane "H".

6. Dimensions in () are for reference only.

For the most recent package outline drawing, see [M8.15](#).

M8.15

8 Lead Narrow Body Small Outline Plastic Package

Rev 7, 9/2023

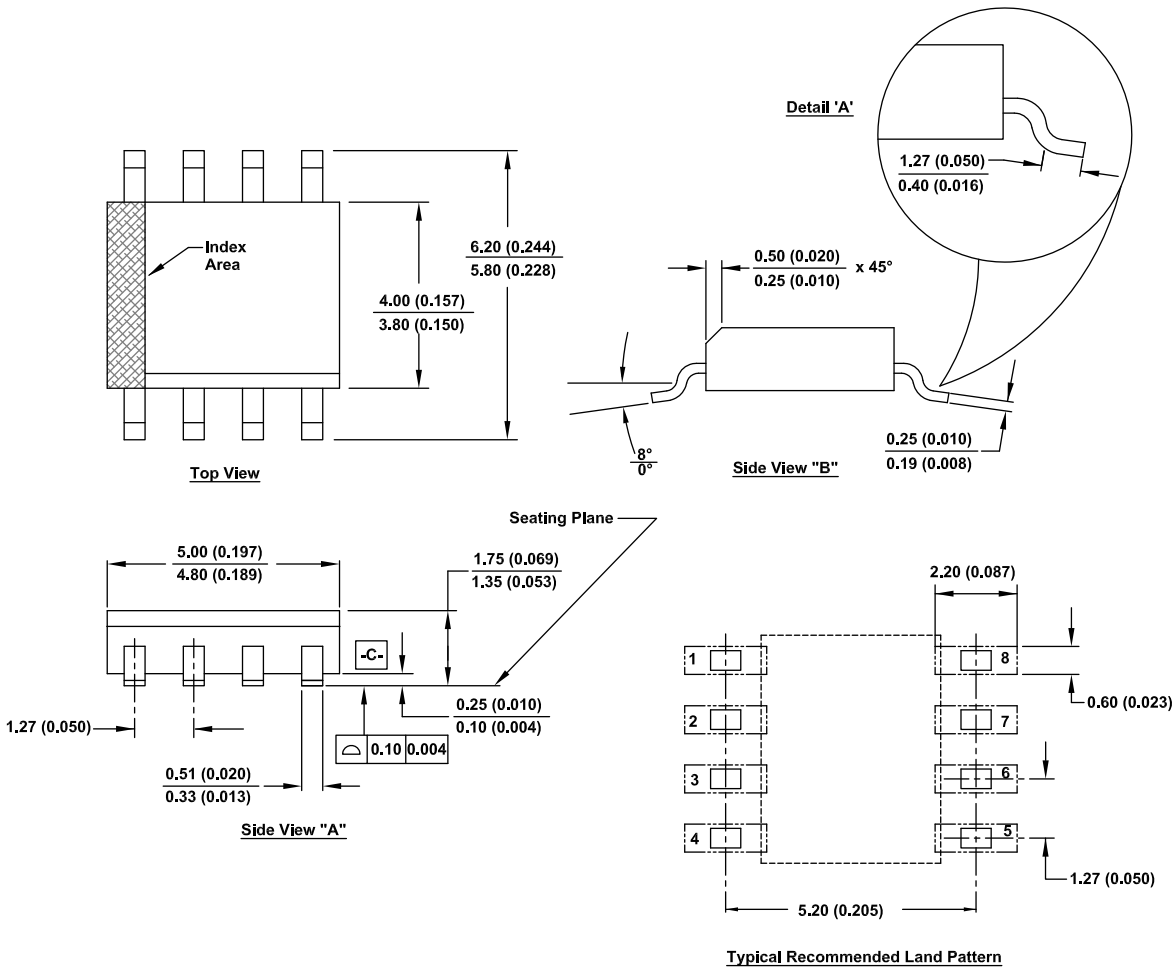

Notes:

1. Dimensioning and tolerancing conform to ASME Y14.5M-1994.
2. Package length does not include mold flash, protrusion or gate burrs. Mold flash, protrusion and gate burrs shall not exceed 0.15mm (0.006 inch) per side.
3. Package width does not include interlead flash or protrusions. Interlead flash and protrusions shall not exceed 0.25mm (0.010 inch) per side.
4. The chamfer on the body is optional. If it is not present, a visual index feature must be located within the crosshatched area.
5. Terminal numbers are shown for reference only.
6. The lead width as measured 0.36mm (0.014 inch) or greater above the seating plane, shall not exceed a maximum value of 0.61mm (0.024 inch)
7. Controlling dimension: MILLIMETER. Converted inch dimension are not necessarily exact.
8. This outline conforms to JEDEC publication MS-012-AA ISSUE C.

For the most recent package outline drawing, see [M10.118](#).

M10.118
 10 Lead Mini Small Outline Plastic Package
 Rev 2, 5/2021

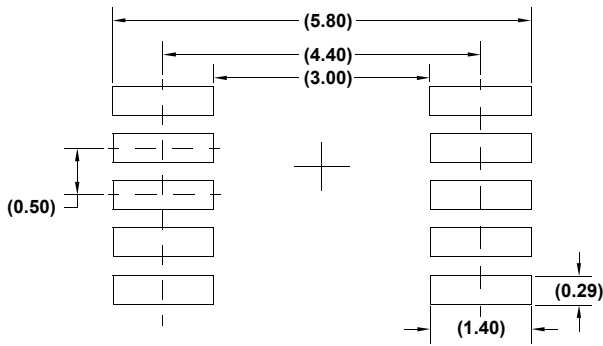
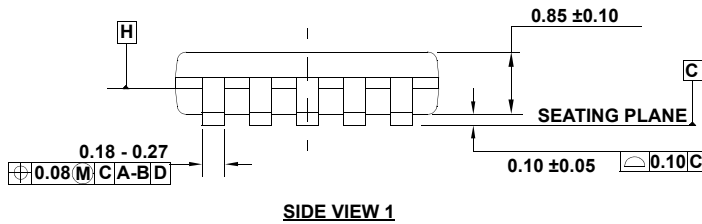
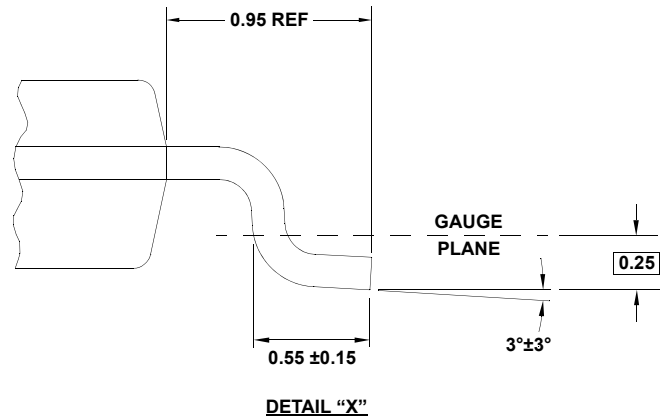
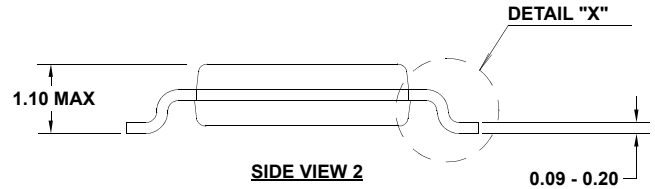
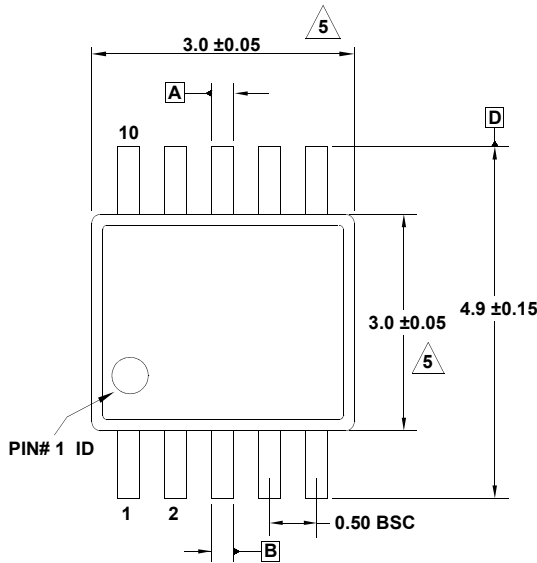

NOTES:

1. Dimensions are in millimeters.
2. Dimensioning and tolerancing conform to JEDEC MO-187-BA and AMSEY14.5m-1994.
3. Plastic or metal protrusions of 0.15mm max per side are not included.
4. Plastic interlead protrusions of 0.15mm max per side are not included.
5. Dimensions are measured at Datum Plane "H".
6. Dimensions in () are for reference only.

For the most recent package outline drawing, see [M14.15](#).

M14.15
 14 Lead Narrow Body Small Outline Plastic Package
 Rev 2, 6/20

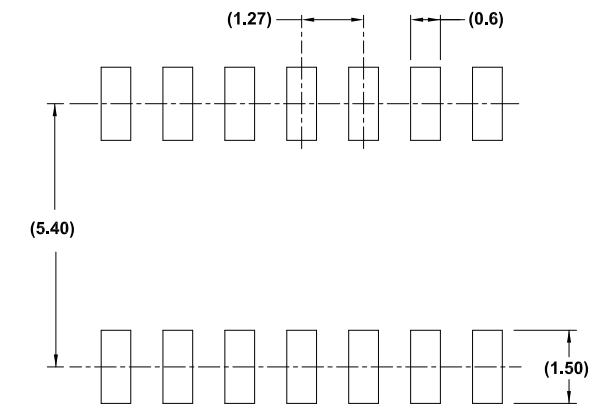
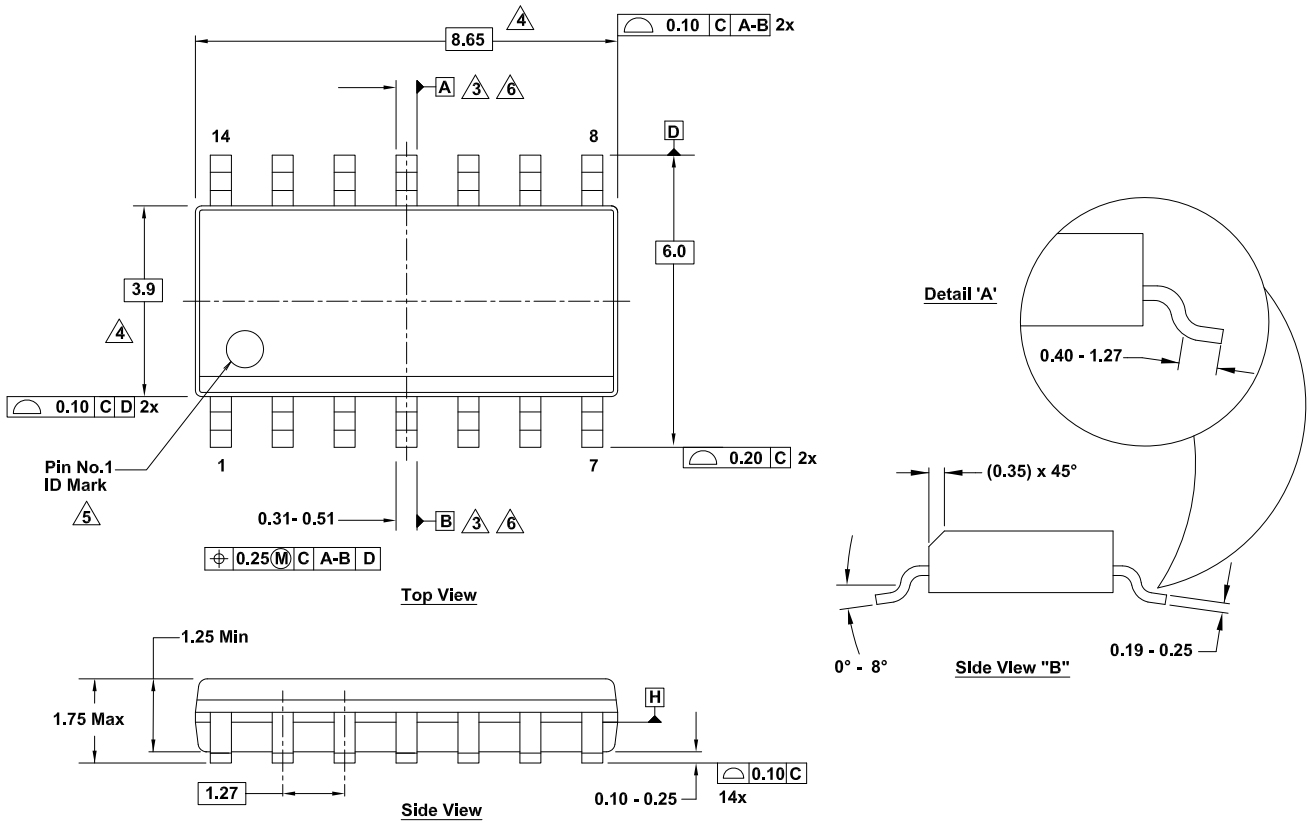

Typical Recommended Land Pattern

- Notes:
1. Dimensions are in millimeters.
 Dimensions in () for reference only.
 2. Dimensioning and tolerancing conform to ASME Y14.5m-1994.
 3. Datums A and B are determined at Datum H.
 4. Dimension does not include interlead flash or protrusions.
 Interlead flash or protrusions shall not exceed 0.25mm per side.
 5. The pin #1 identifier can be either a mold or mark feature.
 6. Does not include dambar protrusion. Allowable dambar protrusion shall be 0.10mm total in excess of lead width at maximum condition.
 7. Reference to JEDEC MS-012-AB.

IMPORTANT NOTICE AND DISCLAIMER

RENESAS ELECTRONICS CORPORATION AND ITS SUBSIDIARIES (“RENESAS”) PROVIDES TECHNICAL SPECIFICATIONS AND RELIABILITY DATA (INCLUDING DATASHEETS), DESIGN RESOURCES (INCLUDING REFERENCE DESIGNS), APPLICATION OR OTHER DESIGN ADVICE, WEB TOOLS, SAFETY INFORMATION, AND OTHER RESOURCES “AS IS” AND WITH ALL FAULTS, AND DISCLAIMS ALL WARRANTIES, EXPRESS OR IMPLIED, INCLUDING, WITHOUT LIMITATION, ANY IMPLIED WARRANTIES OF MERCHANTABILITY, FITNESS FOR A PARTICULAR PURPOSE, OR NON-INFRINGEMENT OF THIRD PARTY INTELLECTUAL PROPERTY RIGHTS.

These resources are intended for developers skilled in the art designing with Renesas products. You are solely responsible for (1) selecting the appropriate products for your application, (2) designing, validating, and testing your application, and (3) ensuring your application meets applicable standards, and any other safety, security, or other requirements. These resources are subject to change without notice. Renesas grants you permission to use these resources only for development of an application that uses Renesas products. Other reproduction or use of these resources is strictly prohibited. No license is granted to any other Renesas intellectual property or to any third party intellectual property. Renesas disclaims responsibility for, and you will fully indemnify Renesas and its representatives against, any claims, damages, costs, losses, or liabilities arising out of your use of these resources. Renesas' products are provided only subject to Renesas' Terms and Conditions of Sale or other applicable terms agreed to in writing. No use of any Renesas resources expands or otherwise alters any applicable warranties or warranty disclaimers for these products.

(Disclaimer Rev.1.0 Mar 2020)

Corporate Headquarters

TOYOSU FORESIA, 3-2-24 Toyosu,
Koto-ku, Tokyo 135-0061, Japan
www.renesas.com

Contact Information

For further information on a product, technology, the most up-to-date version of a document, or your nearest sales office, please visit:
www.renesas.com/contact/

Trademarks

Renesas and the Renesas logo are trademarks of Renesas Electronics Corporation. All trademarks and registered trademarks are the property of their respective owners.

Looking for pricing, stock, or lifecycle information?

Click below to explore more details on WIN SOURCE:

-  [View ISL3178EIUZ-T on WIN SOURCE](#)
-  [Renesas Electronics America](#) Information

Optimize Your Supply Chain with WIN SOURCE Solutions

-  Global Sourcing Solution
-  Obsolete Management
-  Cost Control Management
-  Shortage Management
-  Alternative Solution
-  Excess Inventory Management