



**THE DATASHEET OF
DMN5L06VK-7-G**



DUAL N-CHANNEL ENHANCEMENT MODE MOSFET

Features

- Dual N-Channel MOSFET
- Low On-Resistance
- Very Low Gate Threshold Voltage, 1.0V Max
- Low Input Capacitance
- Fast Switching Speed
- Low Input/Output Leakage
- Ultra-Small Surface Mount Package
- **Totally Lead-Free & Fully RoHS Compliant (Notes 1 & 2)**
- **Halogen and Antimony Free. "Green" Device (Note 3)**
- **ESD Protected up to 2kV**
- This part is qualified to JEDEC standards (as references in AEC-Q) for High Reliability.
<https://www.diodes.com/quality/product-definitions/>
- An Automotive-Compliant Part is Available Under Separate Datasheet ([DMN5L06VKQ](#))

Mechanical Data

- Package: SOT563
- Package Material: Molded Plastic, "Green" Molding Compound. UL Flammability Classification Rating 94V-0
- Moisture Sensitivity: Level 1 per J-STD-020
- Terminal Connections: See Diagram
- Terminals: Finish – Matte Tin Annealed over Copper Leadframe. Solderable per MIL-STD-202, Method 208 (E3)
- Weight: 0.006 grams (Approximate)



ESD protected up to 2kV

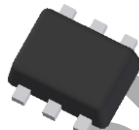

SOT563
Top View

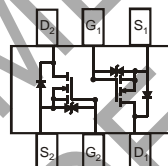

DMN5L06VK

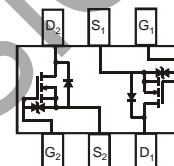

DMN5L06VAK
DMN5010VAK

Ordering Information (Note 4)

Part Number	Package	Packing	
		Qty.	Carrier
DMN5L06VK-7	SOT563	3,000	Tape & Reel
DMN5L06VK-7A	SOT563	3,000	Tape & Reel
DMN5L06VK-13	SOT563	10,000	Tape & Reel
DMN5L06VK-13A	SOT563	10,000	Tape & Reel
DMN5L06VAK-7	SOT563	3,000	Tape & Reel
DMN5L06VAK-7A	SOT563	3,000	Tape & Reel
DMN5L06VAK-13	SOT563	10,000	Tape & Reel
DMN5L06VAK-13A	SOT563	10,000	Tape & Reel
DMN5010VAK-7	SOT563	3,000	Tape & Reel
DMN5010VAK-7A	SOT563	3,000	Tape & Reel
DMN5010VAK-13	SOT563	10,000	Tape & Reel
DMN5010VAK-13A	SOT563	10,000	Tape & Reel

- Notes:
1. No purposely added lead. Fully EU Directive 2002/95/EC (RoHS), 2011/65/EU (RoHS 2) & 2015/863/EU (RoHS 3) compliant.
 2. See <https://www.diodes.com/quality/lead-free/> for more information about Diodes Incorporated's definitions of Halogen- and Antimony-free, "Green" and Lead-free.
 3. Halogen- and Antimony-free "Green" products are defined as those which contain <900ppm bromine, <900ppm chlorine (<1500ppm total Br + Cl) and <1000ppm antimony compounds.
 4. For packaging details, go to our website at <https://www.diodes.com/design/support/packaging/diodes-packaging/>.

Marking Information (Notes 5 & 6)

DMN5L06VK-7/-13 (Note 5)

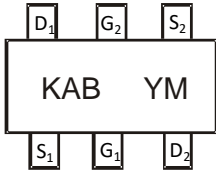

DMN5L06VK-7A/-13A (Note 6)

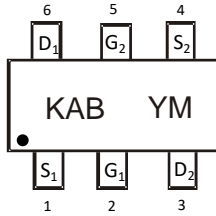

KAB= DMN5L06VK Product Type
Marking Code
YM= Date Code Marking
Y = Year (ex: J = 2022)
M = Month (ex: 9 = September)

**DMN5L06VAK-7/-13 (Note 5)
DMN5010VAK-7/-13 (Note 5)**

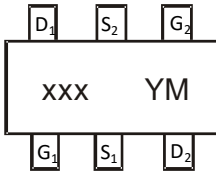

**DMN5L06VAK-7A/-13A (Note 6)
DMN5010VAK-7A/-13A (Note 6)**

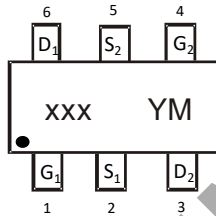

xxx = Product Type Marking Code:
KAE or KAE or KAC
YM= Date Code Marking
Y = Year (ex: J = 2022)
M = Month (ex: 9 = September)

Date Code Key

Year	2006	...	2022	2023	2024	2025	2026	2027	2028	2029	2030	2031
Code	T	...	J	K	L	M	N	O	P	R	S	T
Month	Jan	Feb	Mar	Apr	May	Jun	Jul	Aug	Sep	Oct	Nov	Dec
Code	1	2	3	4	5	6	7	8	9	O	N	D

Notes: 5. Package is non-polarized. Parts may be on reel in orientation illustrated, 180° rotated, or mixed (both ways).
6. Part number with suffix 7A and 13A designates devices marked with a Pin 1 indicator. There is no other difference between both devices.

NOT RECOMMENDED FOR NEW DESIGN

Maximum Ratings (@T_A = +25°C, unless otherwise specified.)

Characteristic	Symbol	Value	Unit
Drain-Source Voltage	V _{DSS}	50	V
Drain-Gate Voltage R _{GS} ≤ 1.0MΩ	V _{DGR}	50	V
Gate-Source Voltage	V _{GSS}	±20	V
		±40	
Drain Current (Note 7)	I _D	280	mA
	I _{DM}	1.5	A

Thermal Characteristics

Characteristic	Symbol	Value	Unit
Total Power Dissipation (Note 7)	P _D	250	mW
Thermal Resistance, Junction to Ambient (Note 7)	R _{θJA}	500	°C/W
Operating and Storage Temperature Range	T _J , T _{STG}	-55 to +150	°C

Electrical Characteristics (@T_A = +25°C, unless otherwise specified.)

Characteristic	Symbol	Min	Typ	Max	Unit	Test Condition
OFF CHARACTERISTICS (Note 8)						
Drain-Source Breakdown Voltage	BV _{DSS}	50	—	—	V	V _{GS} = 0V, I _D = 10μA
Zero Gate Voltage Drain Current	I _{DSS}	—	—	60	nA	V _{DS} = 50V, V _{GS} = 0V
Gate-Body Leakage	I _{GSS}	—	—	1	μA	V _{GS} = ±12V, V _{DS} = 0V V _{GS} = ±10V, V _{DS} = 0V V _{GS} = ±5V, V _{DS} = 0V
				500	nA	
				50	nA	
ON CHARACTERISTICS (Note 8)						
Gate Threshold Voltage	V _{GS(TH)}	0.49 0.30	—	1.0 1.2	V	V _{DS} = V _{GS} , I _D = 250μA @T _J = +25°C @T _J = +0°C to +85°C (Note 9)
Static Drain-Source On-Resistance	R _{DS(ON)}	—	—	3.0	Ω	V _{GS} = 1.8V, I _D = 50mA V _{GS} = 2.5V, I _D = 50mA V _{GS} = 5.0V, I _D = 50mA
				2.5		
				2.0		
On-State Drain Current	I _{D(ON)}	0.5	1.4	—	A	V _{GS} = 10V, V _{DS} = 7.5V
Forward Transconductance	Y _{fs}	200	—	—	mS	V _{DS} = 10V, I _D = 0.2A
Source-Drain Diode Forward Voltage	V _{SD}	0.5	—	1.4	V	V _{GS} = 0V, I _S = 115mA
DYNAMIC CHARACTERISTICS (Note 9)						
Input Capacitance	C _{iss}	—	—	50	pF	V _{DS} = 25V, V _{GS} = 0V f = 1.0MHz
Output Capacitance	C _{oss}	—	—	25	pF	
Reverse Transfer Capacitance	C _{rss}	—	—	5.0	pF	

- Notes:
7. Device mounted on FR-4 substrate PC board, 2oz copper, with minimum recommended pad layout.
 8. Short duration pulse test used to minimize self-heating effect.
 9. Guaranteed by design. Not subject to product testing.

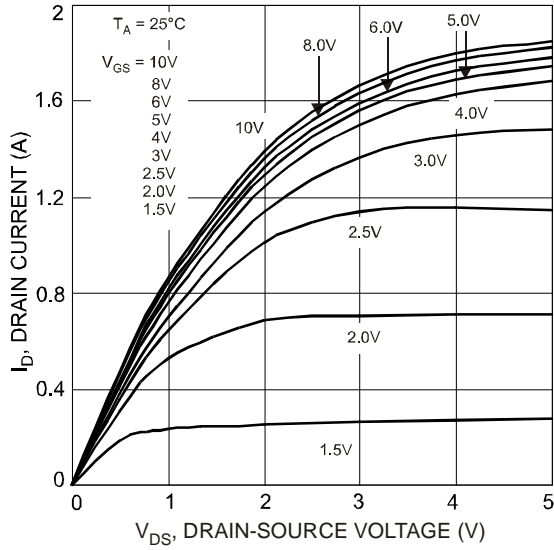

Fig. 1 Typical Output Characteristics

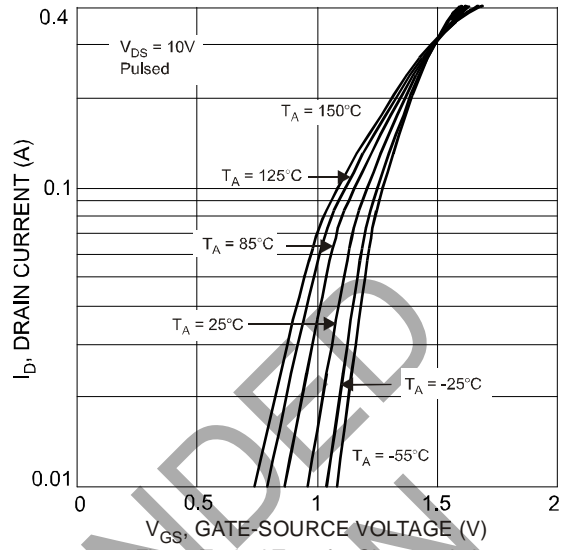

Fig. 2 Typical Transfer Characteristics

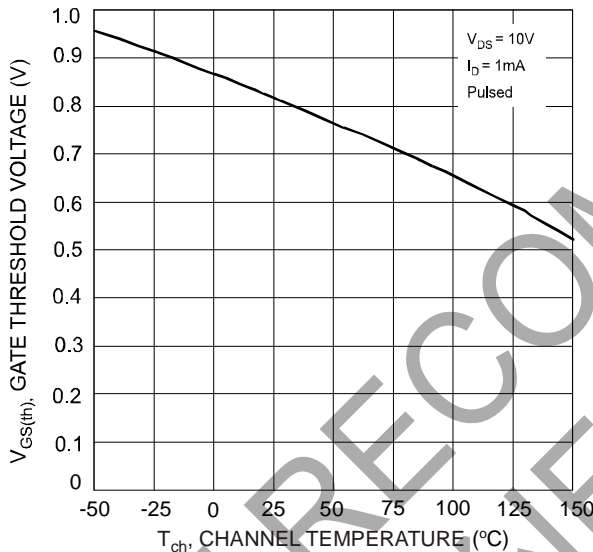

Fig. 3 Gate Threshold Voltage vs. Channel Temperature

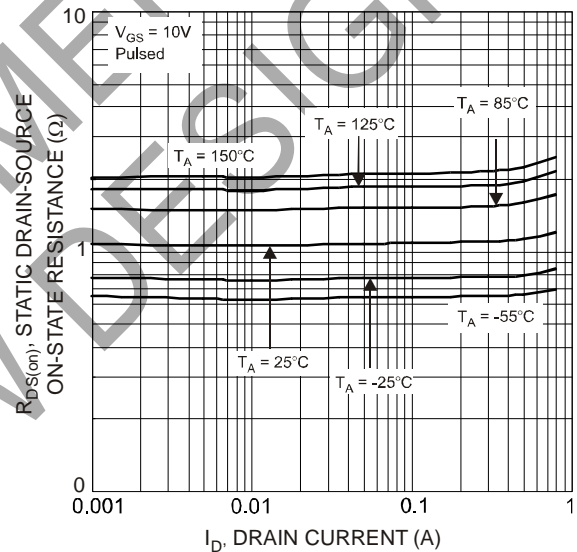

Fig. 4 Static Drain-Source On-Resistance vs. Drain Current

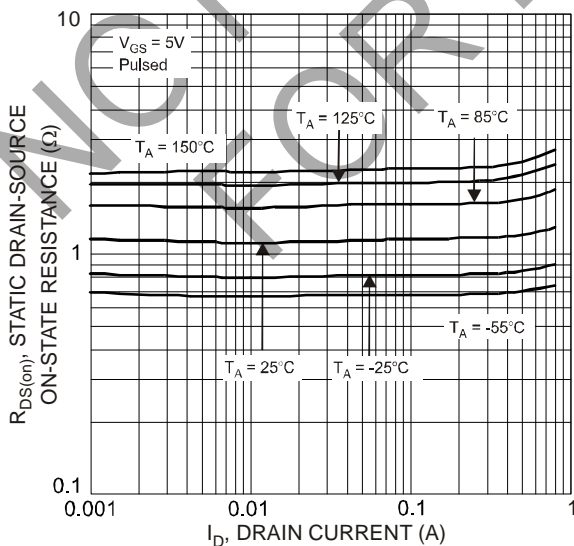

Fig. 5 Static Drain-Source On-Resistance vs. Drain Current

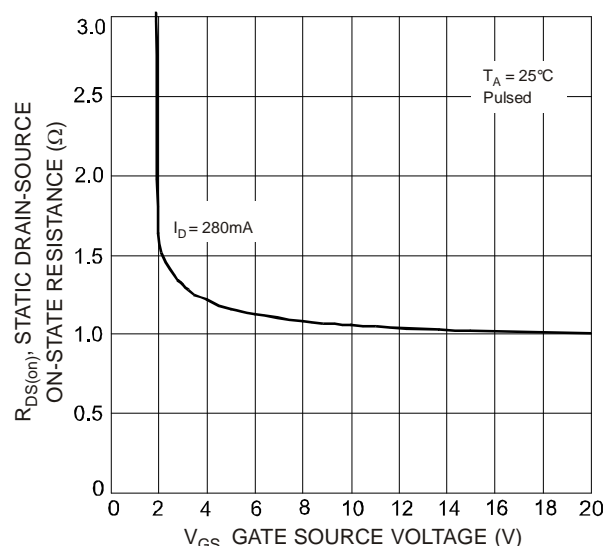

Fig. 6 Static Drain-Source On-Resistance vs. Gate-Source Voltage

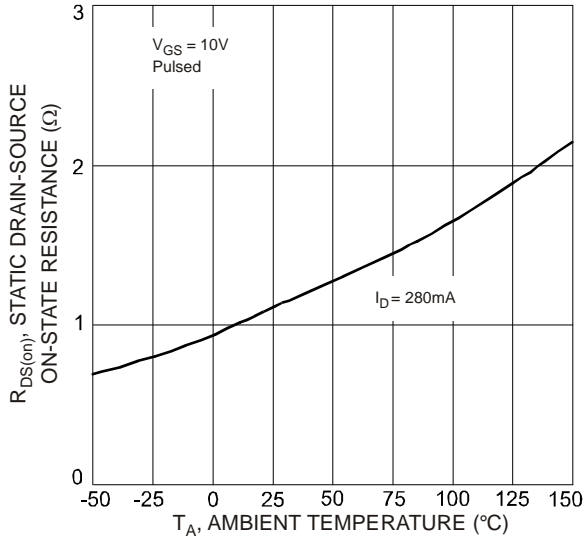

Fig. 7 Static Drain-Source On-State Resistance vs. Ambient Temperature

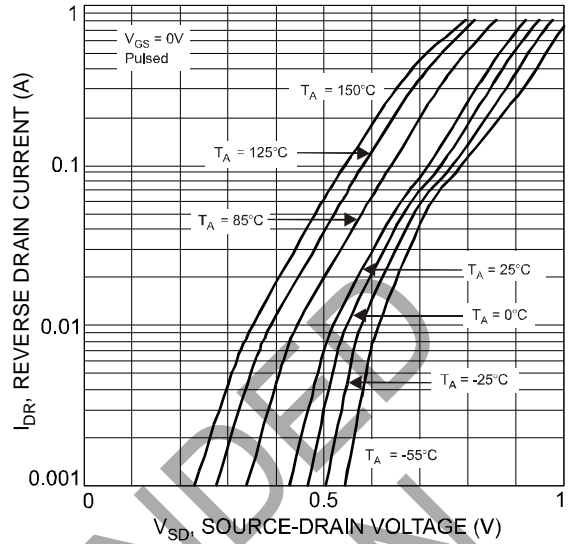

Fig. 8 Reverse Drain Current vs. Source-Drain Voltage

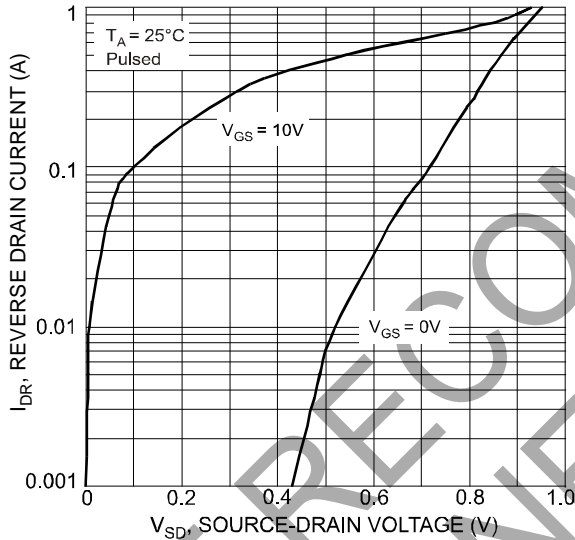

Fig. 9 Reverse Drain Current vs. Source-Drain Voltage

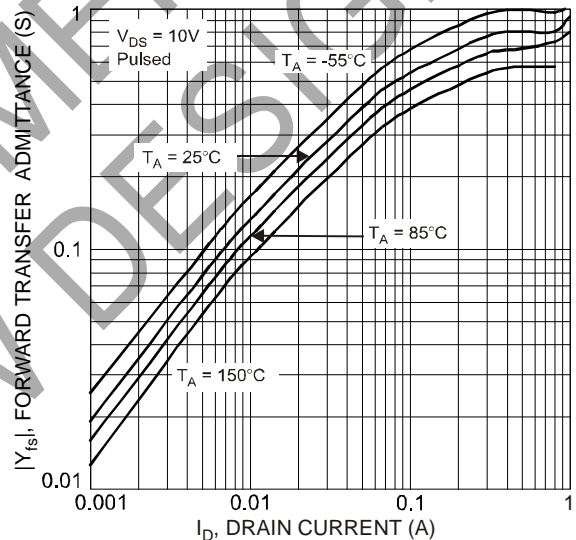

Fig. 10 Forward Transfer Admittance vs. Drain Current

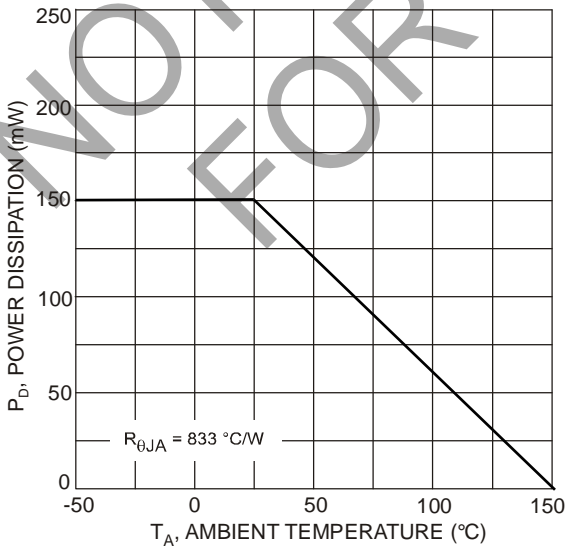
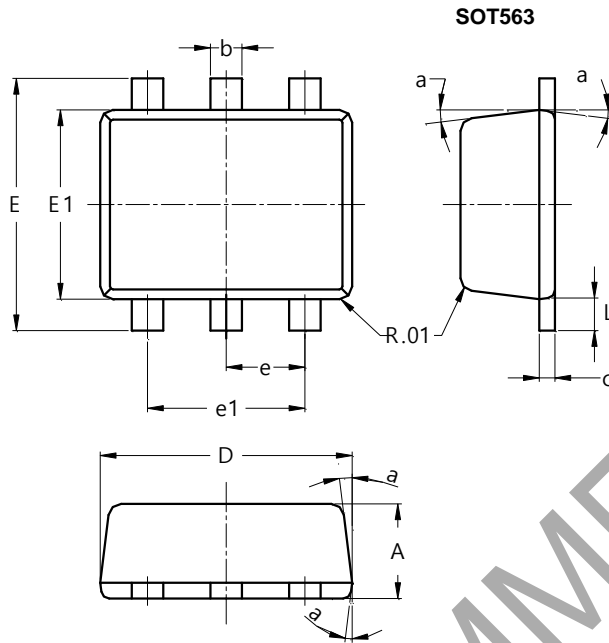

Fig. 11 Derating Curve - Total

Package Outline Dimensions

Please see <http://www.diodes.com/package-outlines.html> for the latest version.



SOT563			
Dim	Min	Max	Typ
A	0.55	0.60	--
b	0.15	0.30	0.20
c	0.10	0.18	0.11
D	1.50	1.70	1.60
E	1.55	1.70	1.60
E1	1.10	1.25	1.20
e	--	--	0.50
e1	0.90	1.10	1.00
L	0.10	0.30	0.20
a	8°	9°	7°
All Dimensions in mm			

Suggested Pad Layout

Please see <http://www.diodes.com/package-outlines.html> for the latest version.

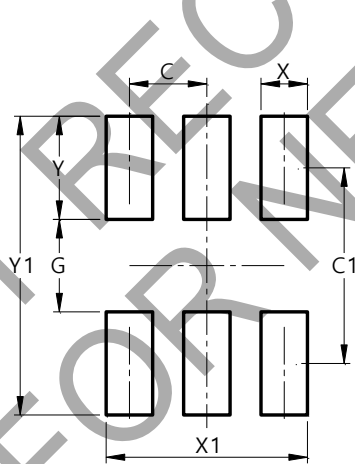

Dimensions	Value (in mm)
C	0.500
C1	1.270
G	0.600
X	0.300
X1	1.300
Y	0.670
Y1	1.940

IMPORTANT NOTICE



1. DIODES INCORPORATED (Diodes) AND ITS SUBSIDIARIES MAKE NO WARRANTY OF ANY KIND, EXPRESS OR IMPLIED, WITH REGARDS TO ANY INFORMATION CONTAINED IN THIS DOCUMENT, INCLUDING, BUT NOT LIMITED TO, THE IMPLIED WARRANTIES OF MERCHANTABILITY, FITNESS FOR A PARTICULAR PURPOSE OR NON-INFRINGEMENT OF THIRD PARTY INTELLECTUAL PROPERTY RIGHTS (AND THEIR EQUIVALENTS UNDER THE LAWS OF ANY JURISDICTION).
2. The Information contained herein is for informational purpose only and is provided only to illustrate the operation of Diodes' products described herein and application examples. Diodes does not assume any liability arising out of the application or use of this document or any product described herein. This document is intended for skilled and technically trained engineering customers and users who design with Diodes' products. Diodes' products may be used to facilitate safety-related applications; however, in all instances customers and users are responsible for (a) selecting the appropriate Diodes products for their applications, (b) evaluating the suitability of Diodes' products for their intended applications, (c) ensuring their applications, which incorporate Diodes' products, comply the applicable legal and regulatory requirements as well as safety and functional-safety related standards, and (d) ensuring they design with appropriate safeguards (including testing, validation, quality control techniques, redundancy, malfunction prevention, and appropriate treatment for aging degradation) to minimize the risks associated with their applications.
3. Diodes assumes no liability for any application-related information, support, assistance or feedback that may be provided by Diodes from time to time. Any customer or user of this document or products described herein will assume all risks and liabilities associated with such use, and will hold Diodes and all companies whose products are represented herein or on Diodes' websites, harmless against all damages and liabilities.
4. Products described herein may be covered by one or more United States, international or foreign patents and pending patent applications. Product names and markings noted herein may also be covered by one or more United States, international or foreign trademarks and trademark applications. Diodes does not convey any license under any of its intellectual property rights or the rights of any third parties (including third parties whose products and services may be described in this document or on Diodes' website) under this document.
5. Diodes' products are provided subject to Diodes' Standard Terms and Conditions of Sale (<https://www.diodes.com/about/company/terms-and-conditions/terms-and-conditions-of-sales/>) or other applicable terms. This document does not alter or expand the applicable warranties provided by Diodes. Diodes does not warrant or accept any liability whatsoever in respect of any products purchased through unauthorized sales channel.
6. Diodes' products and technology may not be used for or incorporated into any products or systems whose manufacture, use or sale is prohibited under any applicable laws and regulations. Should customers or users use Diodes' products in contravention of any applicable laws or regulations, or for any unintended or unauthorized application, customers and users will (a) be solely responsible for any damages, losses or penalties arising in connection therewith or as a result thereof, and (b) indemnify and hold Diodes and its representatives and agents harmless against any and all claims, damages, expenses, and attorney fees arising out of, directly or indirectly, any claim relating to any noncompliance with the applicable laws and regulations, as well as any unintended or unauthorized application.
7. While efforts have been made to ensure the information contained in this document is accurate, complete and current, it may contain technical inaccuracies, omissions and typographical errors. Diodes does not warrant that information contained in this document is error-free and Diodes is under no obligation to update or otherwise correct this information. Notwithstanding the foregoing, Diodes reserves the right to make modifications, enhancements, improvements, corrections or other changes without further notice to this document and any product described herein. This document is written in English but may be translated into multiple languages for reference. Only the English version of this document is the final and determinative format released by Diodes.
8. Any unauthorized copying, modification, distribution, transmission, display or other use of this document (or any portion hereof) is prohibited. Diodes assumes no responsibility for any losses incurred by the customers or users or any third parties arising from any such unauthorized use.
9. This Notice may be periodically updated with the most recent version available at <https://www.diodes.com/about/company/terms-and-conditions/important-notice>

DIODES is a trademark of Diodes Incorporated in the United States and other countries.
The Diodes logo is a registered trademark of Diodes Incorporated in the United States and other countries.
© 2022 Diodes Incorporated. All Rights Reserved.

www.diodes.com

Looking for pricing, stock, or lifecycle information?

Click below to explore more details on WIN SOURCE:

-  [View DMN5L06VK-7-G on WIN SOURCE](#)
-  [Diodes Incorporated Information](#)

Optimize Your Supply Chain with WIN SOURCE Solutions

-  Global Sourcing Solution
-  Obsolete Management
-  Cost Control Management
-  Shortage Management
-  Alternative Solution
-  Excess Inventory Management