



**THE DATASHEET OF
BA6209N**



Reversible motor driver

BA6209 / BA6209N

The BA6209 and BA6209N are reversible-motor drivers suitable for brush motors. Two logic inputs allow three output modes : forward, reverse, and braking. The motor revolving speed can be set arbitrarily by controlling the voltage applied to the motor with the control pin voltage V_R .

●Applications

VCRs and cassette tape recorders

●Features

- 1) Power transistors can handle a large current (1.6A maximally).
- 2) Brake is applied when stopping the motor.
- 3) Built-in function to absorb rush currents generated by reversing and braking.
- 4) Motor speed controlling pin.
- 5) Small standby current. ($V_{CC} = 12V$, $I_o = 5.5mA$ typically)
- 6) Stable operation during mode changes either from forward to reverse or vice versa.
- 7) Interface with CMOS devices.

●Block diagram

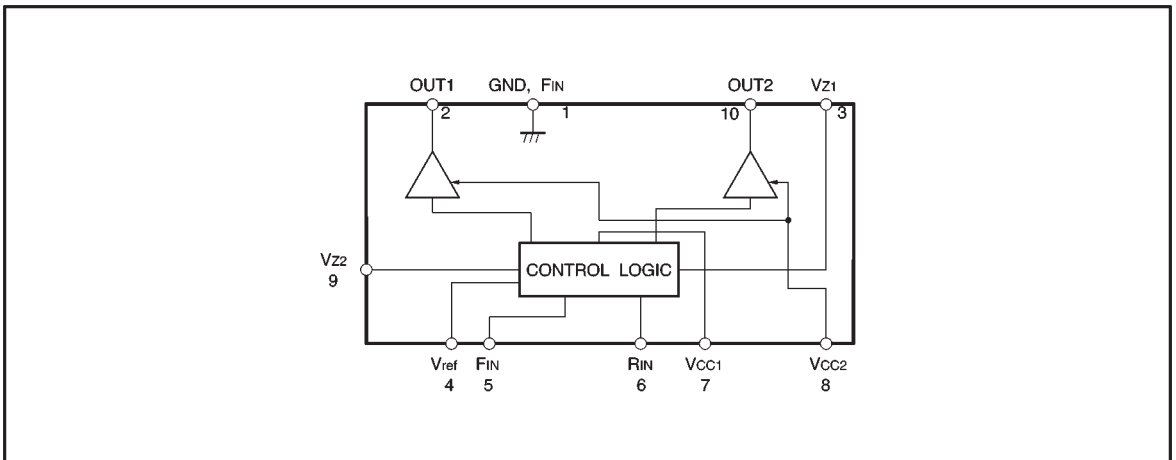

● Absolute maximum ratings (Ta = 25°C)

Parameter	Symbol	Limits	Unit
Power supply voltage	V _{CC}	18	V
Power dissipation	BA6209	2200*1	mW
	BA6209N	1000*2	
Output current	I _o	1.6*3	A
Input voltage	V _{IN}	-0.3~V _{CC}	V
Operating temperature	T _{opr}	-20~+75	°C
Storage temperature	T _{stg}	-55~+125	°C

*1 Reduced by 22 mW for each increase in Ta of 1°C over 25°C.

*2 Reduced by 10 mW for each increase in Ta of 1°C over 25°C.

*3 500 μs pulse with a duty ratio of 1%.

● Recommended operating conditions (Ta = 25°C)

Parameter	Symbol	Min.	Typ.	Max.	Unit
Operating voltage 1 (Logic section)	V _{CC1}	6.0	—	18.0	V
Operating voltage 2 (Output section)	V _{CC2}	—	—	18.0	V

● Electrical characteristics (unless otherwise noted, Ta = 25°C and V_{CC} = 12V)

Parameter	Symbol	Min.	Typ.	Max.	Unit	Conditions
Current dissipation	I _{CC}	—	5.5	10	mA	F _{IN} =R _{IN} =GND, R _L =∞
Minimum input ON current	I _{IN}	—	10	50	μA	R _L =∞
Input threshold voltage	V _{TH}	0.7	1.2	2.0	V	R _L =∞
Output leakage current	I _{OL}	—	—	1.0	mA	F _{IN} =R _{IN} =GND, R _L =∞
Output voltage	V _O	6.6	7.2	—	V	R _L =60Ω, Z _D =7.4V

● Electrical characteristic curves

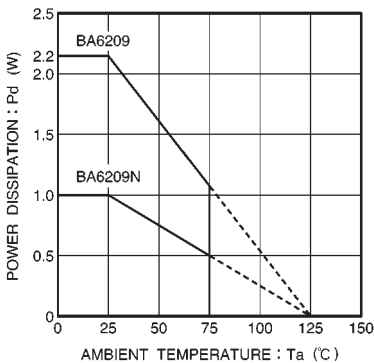

Fig.1 Temperature dependence power dissipation curves

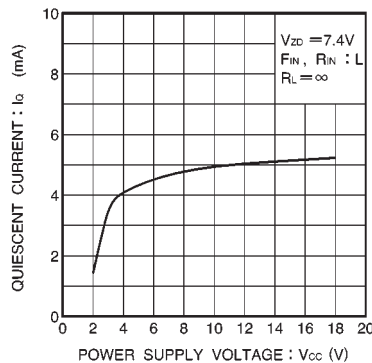

Fig.2 Quiescent current vs. power supply voltage

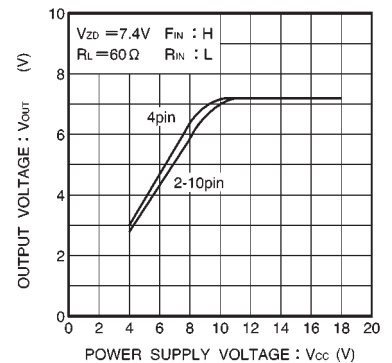

Fig.3 Maximum output voltage vs. power supply voltage (I)

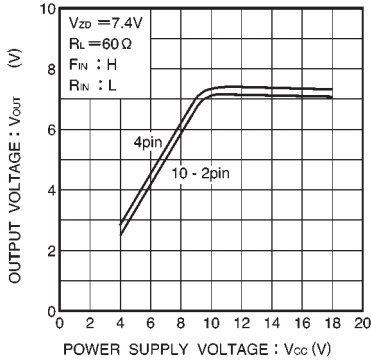

Fig.4 Maximum output voltage vs. power supply voltage (II)

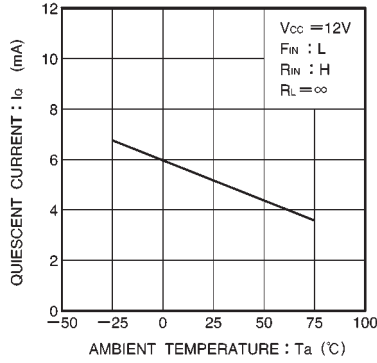

Fig.5 Quiescent current vs. ambient temperature

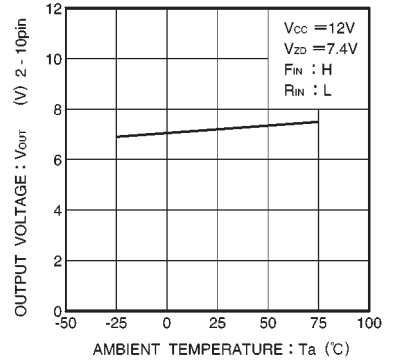

Fig.6 Output voltage vs. ambient temperature

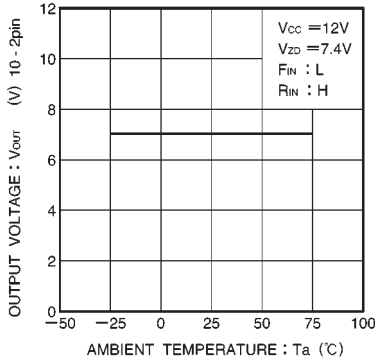

Fig.7 Output voltage vs. ambient temperature

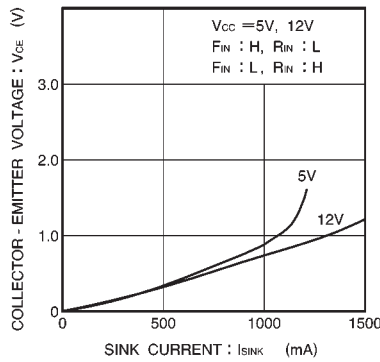

Fig.8 Output saturated voltage vs. sink current (I)

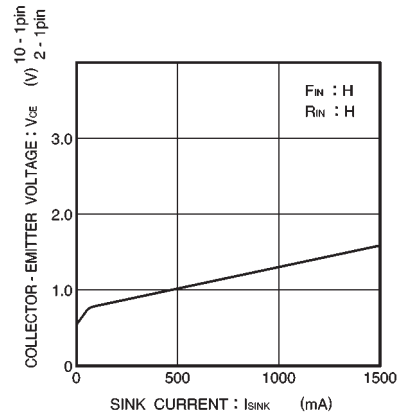

Fig.9 Output saturated voltage vs. sink current (II)

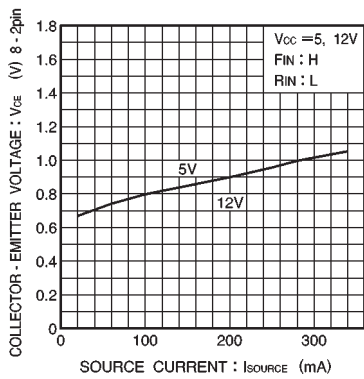

Fig.10 Output saturated voltage vs. source current (I)

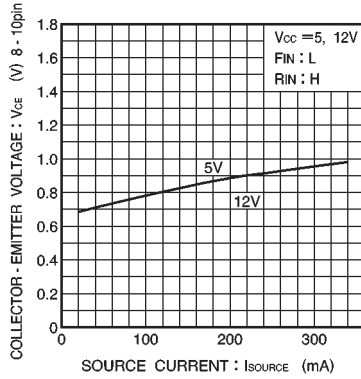

Fig.11 Output saturated voltage vs. source current (II)

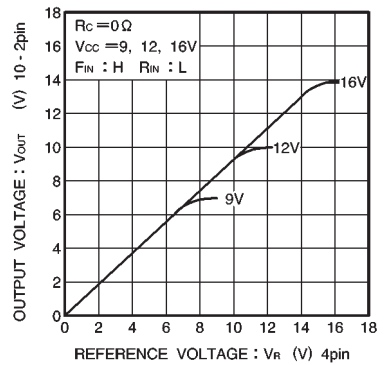

Fig.12 Output voltage vs. reference voltage (I)

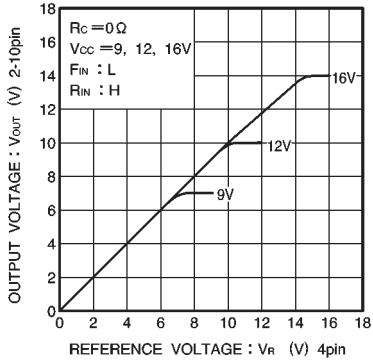

Fig.13 Output voltage vs. reference voltage (II)

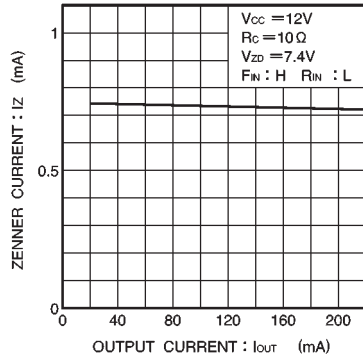

Fig.14 Zener current vs. output current

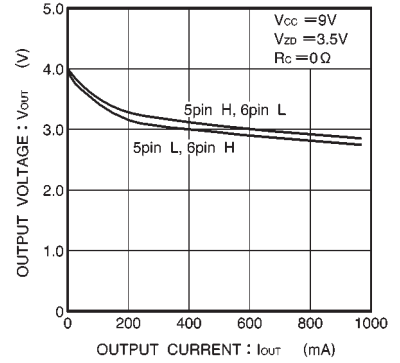

Fig.15 Output voltage vs. output current

● Measurement circuit

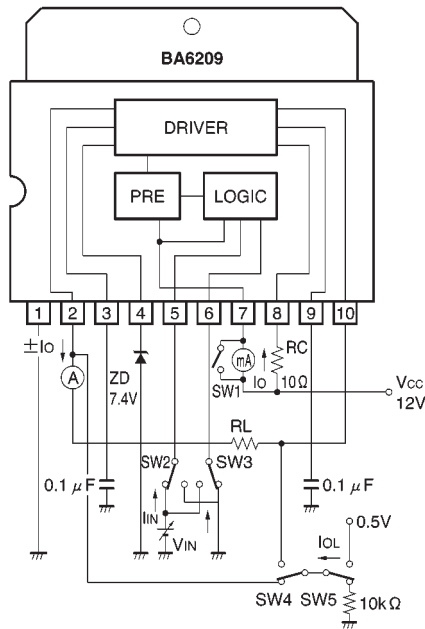

Fig.16

● Circuit operation

Input / output truth table

Input		Output	
F _{IN}	R _{IN}	OUT1	OUT2
L	L	L	L
H	L	H	L
L	H	L	H
H	H	L	L

Forward / reverse control, forced stop, and rush current absorption are controlled by the combination of F_{IN} and R_{IN} input states.

(1) Forward / reverse control circuit

When F_{IN} is HIGH and R_{IN} is LOW, current flows from OUT1 to OUT2. When F_{IN} is LOW and R_{IN} is HIGH, current flows from OUT2 to OUT1 (refer to the truth table).

(2) Forced stop circuit

By setting R_{IN} and F_{IN} both HIGH or both LOW, power supply to the motor is shut down and a brake is applied by absorbing the motor counter-electromotive force.

(3) Rush current absorption circuit

When a high voltage (caused by such as a motor reversal) is generated on OUT1 and OUT2, an internal comparator detects the high voltage and turns on an internal circuit that absorbs rush currents.

(4) Drive circuit

The forward direction of the motor connected between OUT1 and OUT2 corresponds to the current flow from OUT1 to OUT2, and the reverse direction corresponds to the current flow from OUT2 to OUT1. The output voltage (V_{OUT}) applied to the motor is given by the equation :

$$V_{OUT} (V) = V_{ZD} - V_{CE} (sat.) = V_{ZD} - 0.2 (I_{OUT} = 100mA)$$

where V_{ZD} is the zener voltage of the constant voltage diode (ZD) connected to pin 4.

If V_{ref} is left OPEN, the output voltage (V_{OUT}) is given by the equation :

$$V_{OUT} (V) = V_{CC1} - V_{CE} (sat.) (PNP) - 2V_F - V_{CE} (sat.) = V_{CC1} - 1.8 (I_{OUT} = 100mA)$$

● Pin descriptions

Pin No.	Pin name	Function
1	GND	GND
2	OUT 1	Motor output
3	V _{Z1}	Capacitor connection pin for preventing both output transistors being turned on at the same time
4	V _{ref}	Output HIGH voltage setting
5	F _{IN}	Logic input
6	R _{IN}	Logic input
7	V _{CC1}	Control circuit power supply
8	V _{CC2}	Output power supply
9	V _{Z2}	Capacitor connection for preventing both output transistors being turned on at the same time
10	OUT 2	Motor output

● Operation notes

(1) Resistor dividing IC power consumption

To reduce power dissipated in the IC, a resistance (about 3~10Ω) must always be connected between V_{CC} and the power supply pin of the driver circuit. If V_{CC2} is connected to V_{CC} with no resistor, the IC can be damaged by over-current when operated at the voltage range close to the maximum operating voltage.

(2) Control signal waveform

The rise and fall times of signals applied to the control pins should be 5ms or less. Longer times can cause erratic operation of the internal logic circuits and may result in damage to the driver circuits.

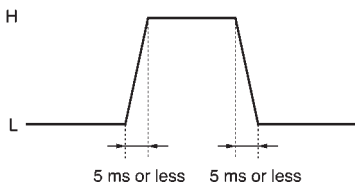

Fig.17 Control signal

For example, if the supply voltage for the external control circuit comes up after the supply voltage of the IC, the rising edge of the control signal slowly follows the rise of the external supply voltage. This could result in erratic operation or damage to the IC due to excess currents.

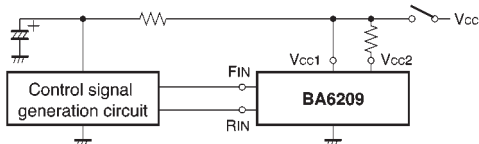

Fig.18

(3) IC ground voltage

To provide separation between the circuit elements within the IC, the GND pin of the IC must always be held at a lower potential than the other pins.

If the potential of the GND pin is allowed to rise above that of other pins (such as the control input pins), separation between the internal circuit elements could break down, resulting in erratic operation or internal damage.

For example, a resistor may be connected between GND (pin 1) and the ground as shown in Fig. 19, when detecting and controlling the motor operating current. In this case, the potential of pin 1 would be above the ground potential by an amount equal to the voltage drop across the resistor. Therefore, dropping the input pin potential to the ground potential would have the effect of applying a negative voltage to the input pin.

This should be avoided by detecting the motor operating current in a way shown in Fig. 20.

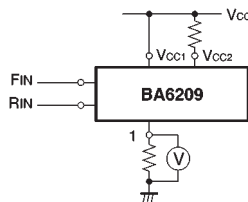

Fig.19

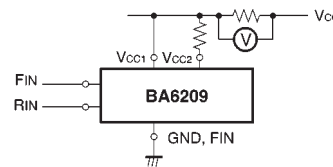

Fig.20

(4) Input pins

Voltage should never be applied to the input pins when the V_{CC} voltage is not applied to the IC. Similarly, when V_{CC} is applied, the voltage on each input pin should be less than V_{CC} and within the guaranteed range for the electrical characteristics.

(5) Back-rush voltage

Depending on the ambient conditions, environment, or motor characteristics, the back-rush voltage may fluctuate. Be sure to confirm that the back-rush voltage will not adversely affect the operation of the IC.

(6) Large current line

Large currents are carried by the motor power supply and motor ground for these ICs.

Therefore, the layout of the pattern of the PC board and the constants of certain parameters for external components, such as the capacitor between the power supply and ground, may cause this large output current to flow back to the input pins, resulting in output oscillation or other malfunctions. To prevent this, make sure that the PC board layout and external circuit constants cause no problems with the characteristics of these ICs.

(7) Power dissipation

The power dissipation will fluctuate depending on the mounting conditions of the IC and the ambient environment. Make sure to carefully check the thermal design of the application where these ICs will be used.

(8) Power consumption

The power consumption by the IC varies widely with the power supply voltage and the output current. Give full consideration to the power dissipation rating and the thermal resistance data and transient thermal resistance data, to provide a thermal design so that none of the ratings for the IC are exceeded.

(9) ASO

Make sure that the output current and supply voltage do not exceed the ASO values.

(10) Precautions for input mode switching

To ensure reliability, it is recommended that the mode switching for the motor pass once through the open mode.

(11) There are no circuits built into these ICs that prevent in-rush currents. Therefore, it is recommended to place a current limiting resistor or other physical counter-measure.

(12) If the potential of the output pin sways greatly and goes below the potential of ground, the operation of the IC may malfunction or be adversely affected. In such a case, place a diode between the output and ground, or other measure, to prevent this.

(13) The quality of these products have been carefully checked; however, use of the products with applied voltages, operating temperatures, or other parameters that exceed the absolute maximum rating given may result in the damage of the IC and the product it is used in. If the IC is damaged, the short mode and open modes cannot be specified, so if the IC is to be used in applications where parameters may exceed the absolute maximum ratings, then be sure to incorporate fuses, or other physical safety measures.

● Application example

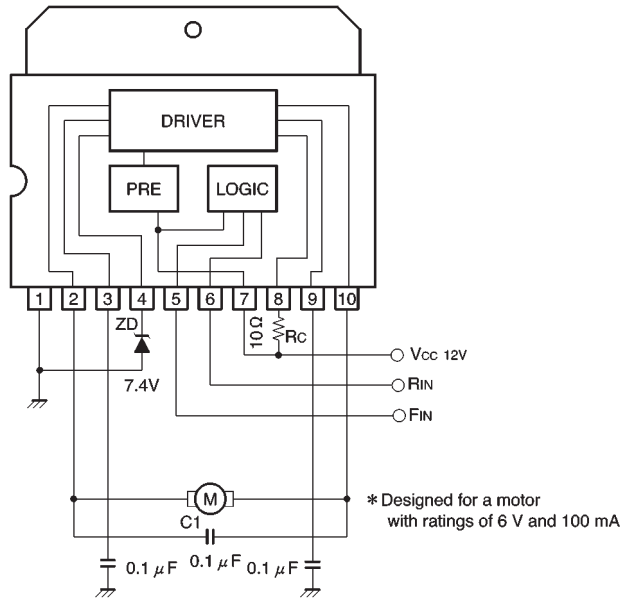
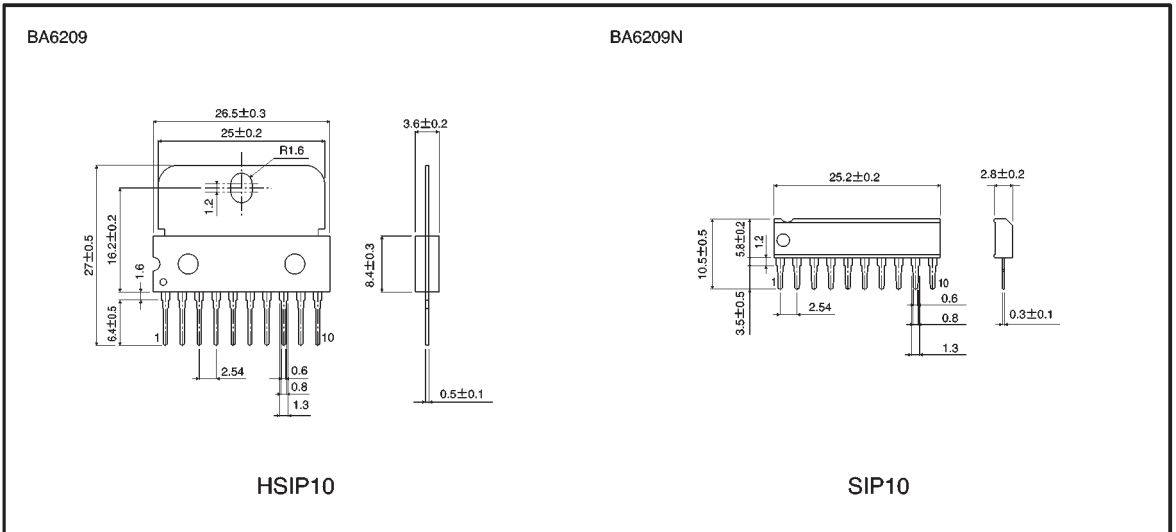



Fig.21

● External dimensions (Units: mm)



Looking for pricing, stock, or lifecycle information?

Click below to explore more details on WIN SOURCE:

-  [View BA6209N on WIN SOURCE](#)
-  [Rohm Semiconductor Information](#)

Optimize Your Supply Chain with WIN SOURCE Solutions

-  Global Sourcing Solution
-  Obsolete Management
-  Cost Control Management
-  Shortage Management
-  Alternative Solution
-  Excess Inventory Management