



## GaAs MMIC 10 WATT T/R SWITCH DC - 4 GHz

### Typical Applications

The HMC784AMS8GE is ideal for:

- Cellular/4G Infrastructure
- WiMAX, WiBro & Fixed Wireless
- Automotive Telematics
- Mobile Radio
- Test Equipment

### Features

- Input P1dB: +40 dBm @ Vdd = +8V
- High Third Order Intercept: +60 dBm
- Positive Control: +3 to +8 V
- Low Insertion Loss: 0.3 dB
- MSOP8G Package: 14.8 mm<sup>2</sup>

### Functional Diagram

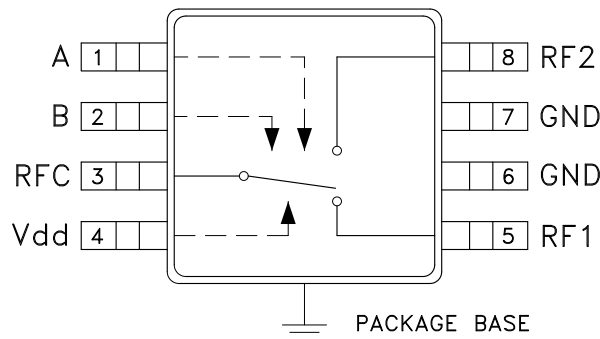

### General Description

The HMC784AMS8GE is a high power SPDT switch in an 8-lead MSOPG package for use in transmit-receive applications which require very low distortion at high input signal power levels. The device can control signals from DC to 4 GHz. The design provides exceptional intermodulation performance; > +60 dBm third order intercept at +5V bias. RF1 and RF2 are reflective shorts when "OFF". On-chip circuitry allows single positive supply operation from +3 Vdc to +8 Vdc at very low DC current with control inputs compatible with CMOS logic families.

### Electrical Specifications,

$T_A = +25^\circ C$ ,  $V_{ctl} = 0/V_{dd}$ ,  $V_{dd} = +5V$  (Unless Otherwise Stated), 50 Ohm System

Parameter	Frequency	Min.	Typ.	Max.	Units
Insertion Loss	DC - 1.0 GHz		0.3	0.6	dB
	DC - 2.0 GHz		0.3	0.8	dB
	DC - 2.5 GHz		0.4	0.9	dB
	DC - 3.0 GHz		0.4	1.0	dB
	DC - 4.0 GHz		0.7	1.5	dB
Isolation	DC - 4.0 GHz	24	28		dB
Return Loss (On State)	DC - 1.0 GHz		30		dB
	DC - 2.0 GHz		26		dB
	DC - 3.0 GHz		20		dB
	DC - 4.0 GHz		14		dB
Input Power for 0.1dB Compression	Vdd = +3V	1.0 - 4.0 GHz	31		dBm
	Vdd = +5V		36		dBm
	Vdd = +8V		38		dBm
Input Power for 1dB Compression	Vdd = +3V	0.1 - 4.0 GHz	32	33	dBm
	Vdd = +5V		35	38	dBm
	Vdd = +8V		38	40	dBm
Input Third Order Intercept (Two-tone input power = +27 dBm each tone)	0.02 - 0.1 GHz		61		dBm
	0.1 - 2.0 GHz		62		dBm
	0.1 - 3.0 GHz		61		dBm
	0.1 - 4.0 GHz		60		dBm
Switching Characteristics	tRISE, tFALL (10/90% RF)	DC - 4.0 GHz	82		ns
	tON, tOFF (50% CTL to 10/90% RF)		112		ns

**GaAs MMIC 10 WATT T/R SWITCH  
DC - 4 GHz**

**Insertion Loss vs. Temperature**

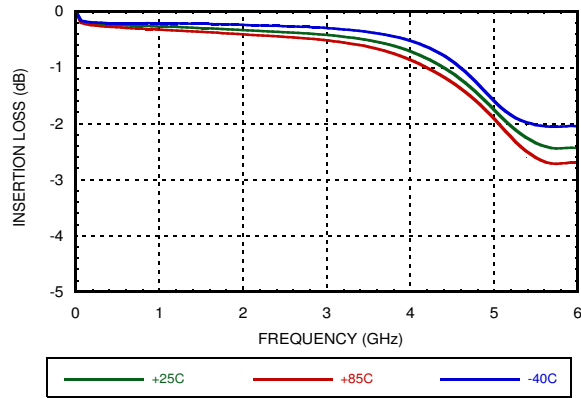

**Isolation**

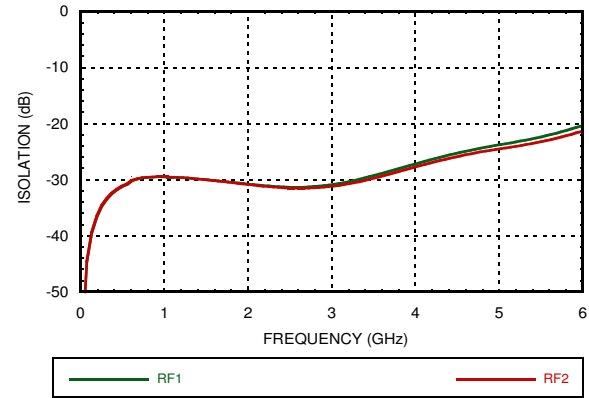

**Insertion Loss vs. Vdd**

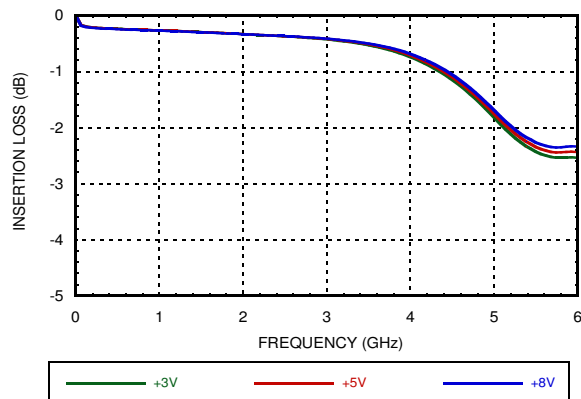

**Isolation vs. Vdd**

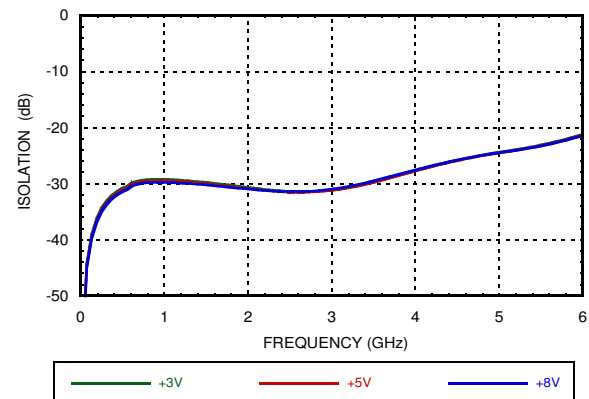

**Return Loss**

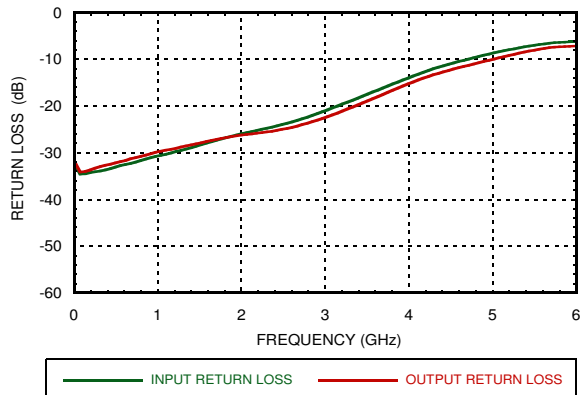

**RF1 to RF2 Isolation**

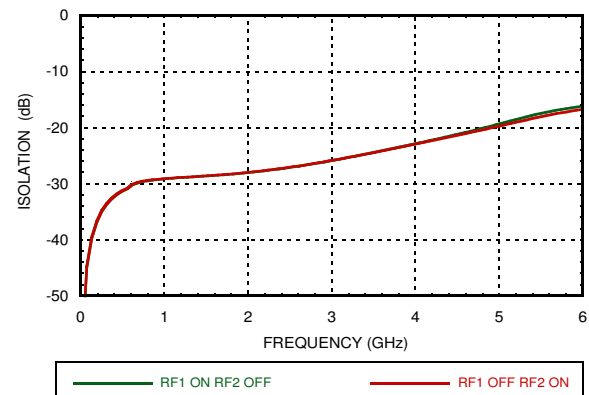

**GaAs MMIC 10 WATT T/R SWITCH  
DC - 4 GHz**

SWITCHES - SPDT - SMT

**Input P1dB vs. Vdd**

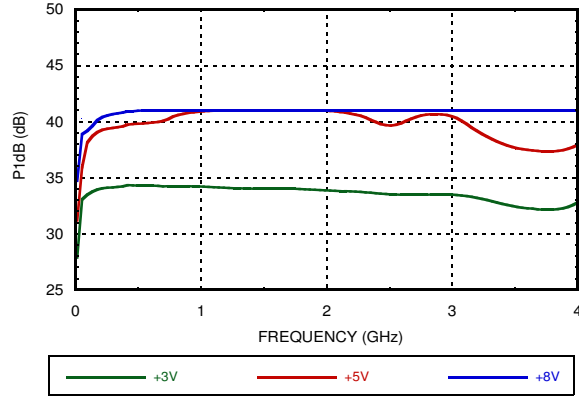

**Input P0.1dB vs. Vdd**

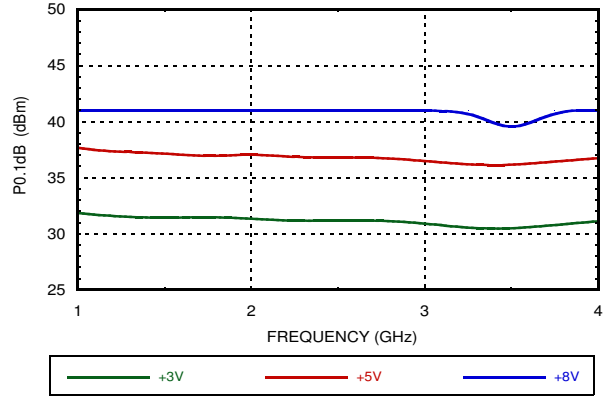

**Input P1dB vs. Temperature @ Vdd = +5V**

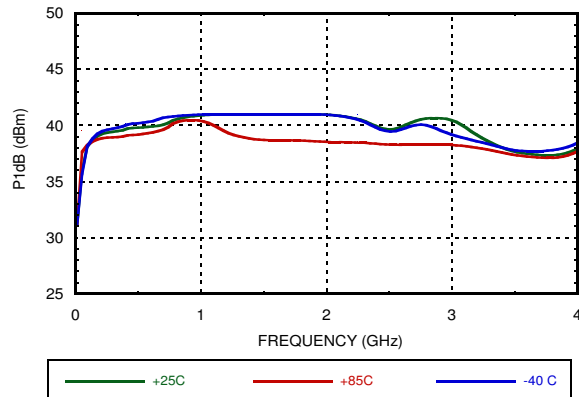

**Input IP3 vs. Tone Power @ Vdd = +3V**

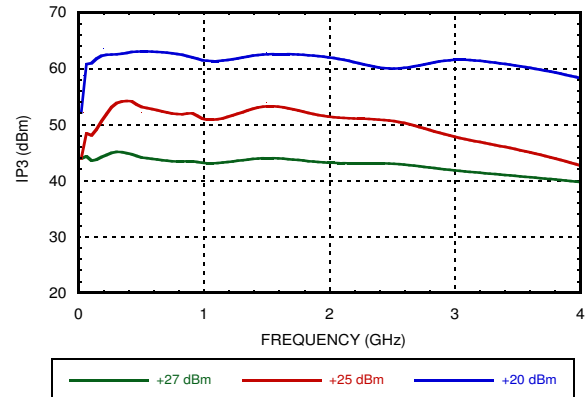

**Input IP3 vs. Tone Power @ Vdd = +5V**

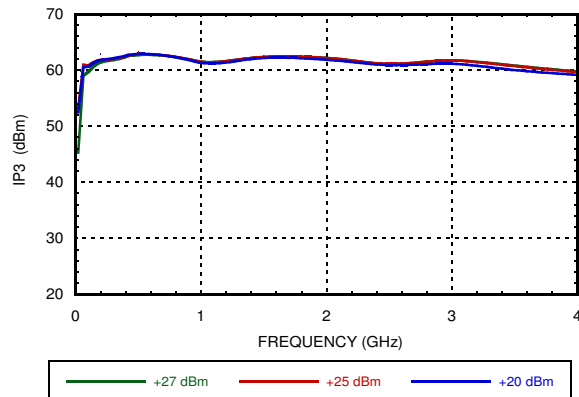

**Input IP3 vs. Tone Power @ Vdd = +8V**

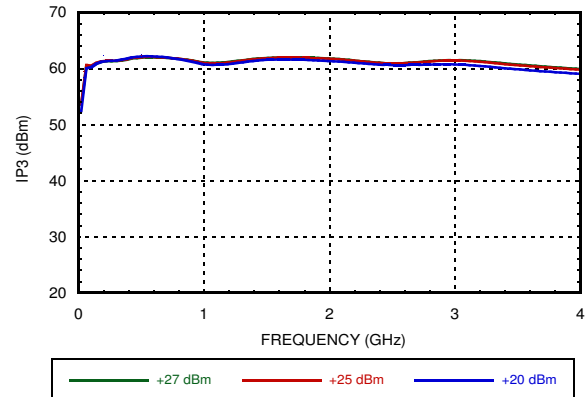

**GaAs MMIC 10 WATT T/R SWITCH  
DC - 4 GHz**

**Input IP3 vs. Temperature  
27 dBm Tones, Vdd = +3V**

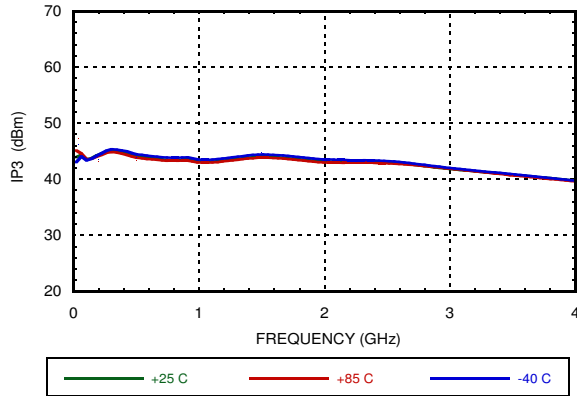

**Input IP3 vs. Temperature  
27 dBm Tones, Vdd = +5V**

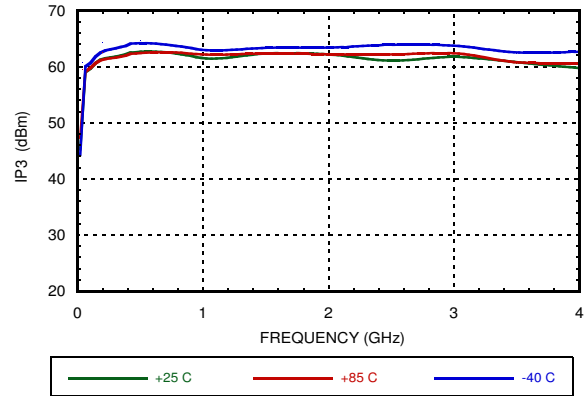

**Input IP3 vs. Temperature  
27 dBm Tones, Vdd = +8V**

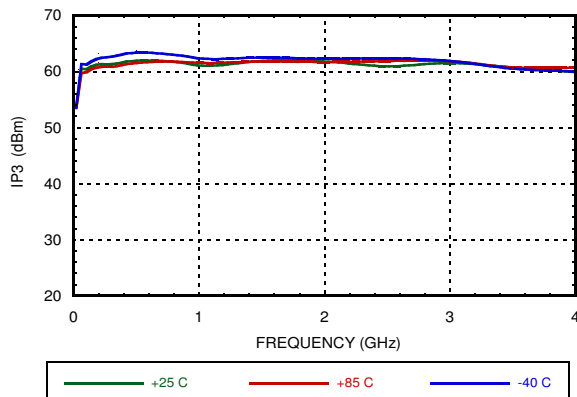

**Input P1dB vs. Vdd**

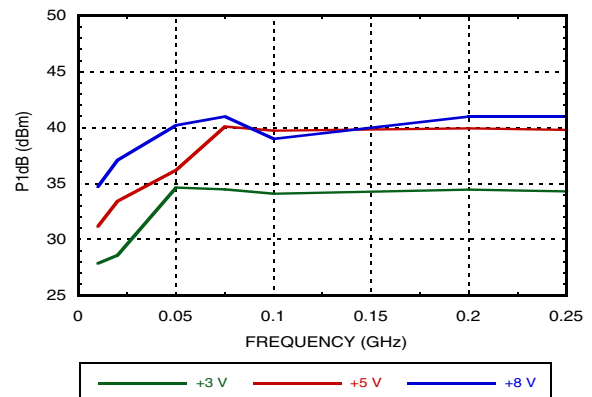

**Input IP3 vs. Tone Power @ Vdd = +5V**

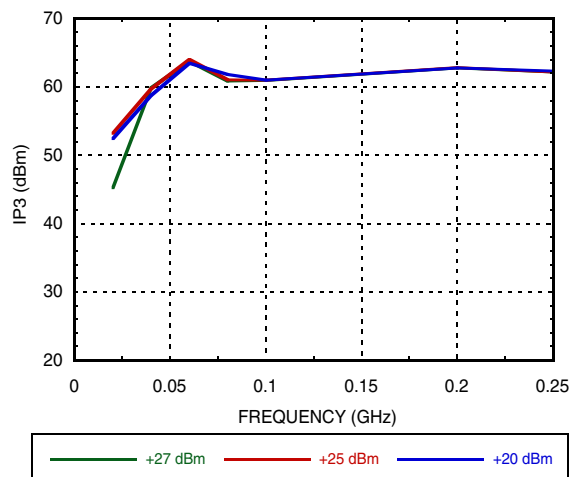

**GaAs MMIC 10 WATT T/R SWITCH  
DC - 4 GHz**
**Bias Voltage & Current**

Vdd (V)	Typical Idd (µA)
+3	0.5
+5	2
+8	20

**Control Voltages & Currents**

State	Vdd = +3V (µA)	Vdd = +5V (µA)	Vdd = +8V (µA)
Low (0 to +0.2V)	0.5	2.0	20
High (Vdd ±0.2V)	0.1	0.1	0.1

**Truth Table**

Control Input (Vctl)		Signal Path State	
A	B	RFC to RF1	RFC to RF2
High	Low	Off	On
Low	High	On	Off

**Absolute Maximum Ratings**

RF Input Power (Vdd = +8V, 50 Ohm source & load impedances)	+39 dBm (T = +85 °C)
Supply Voltage Range (Vdd) (Vctl = 0V)	-0.2 to +9V
Control Voltage Range (A & B)	-0.2 to Vdd +0.5V
Channel Temperature	150 °C
Continuous P <sub>diss</sub> (T = 85 °C) (derate 25 mW/°C above 85 °C)	1.217 W
Thermal Resistance (Channel to ground paddle)	53.4 °C/W
Storage Temperature	-65 to +150 °C
Operating Temperature	-40 to +85 °C
ESD Rating	Class 1A HBM

Note: DC blocking capacitors are required at ports RFC, RF1 and RF2. Their value will determine the lowest transmission frequency.



**ELECTROSTATIC SENSITIVE DEVICE  
OBSERVE HANDLING PRECAUTIONS**

## GaAs MMIC 10 WATT T/R SWITCH DC - 4 GHz

### Outline Drawing

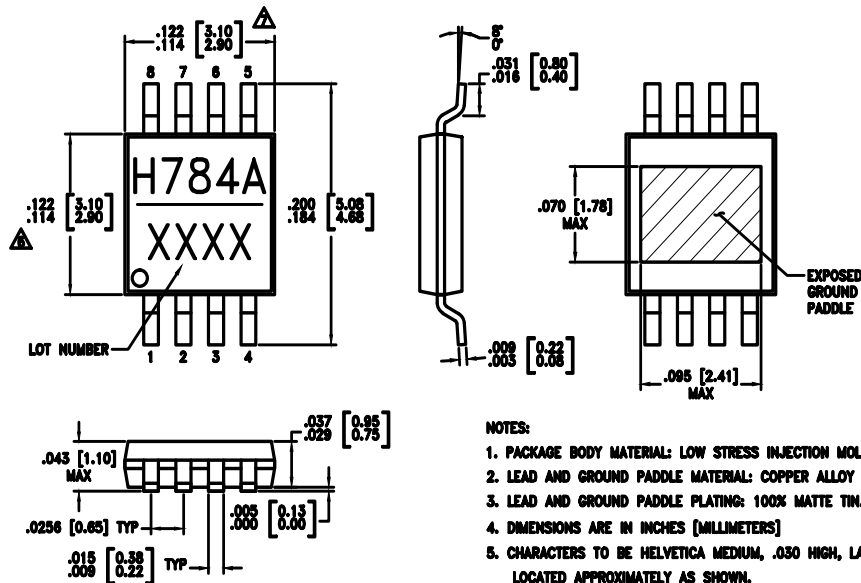

### Package Information

Part Number	Package Body Material	Lead Finish	MSL Rating	Package Marking <sup>[1]</sup>
HMC784AMS8GE	RoHS-compliant Low Stress Injection Molded Plastic	100% matte Sn	MSL1 <sup>[2]</sup>	H784A XXXX

[1] 4-Digit lot number XXXX

[2] Max peak reflow temperature of 260 °C

## GaAs MMIC 10 WATT T/R SWITCH DC - 4 GHz

### Pin Descriptions

Pin Number	Function	Description	Interface Schematic
1	A	See truth table and control voltage table.	
2	B	See truth table and control voltage table.	
3, 5, 8	RFC, RF1, RF2	This pin is DC coupled and matched to 50 Ohms. Blocking capacitors are required.	
4	Vdd	Supply Voltage	
6, 7	GND	Package bottom must also be connected to PCB RF ground.	

### Typical Application Circuit

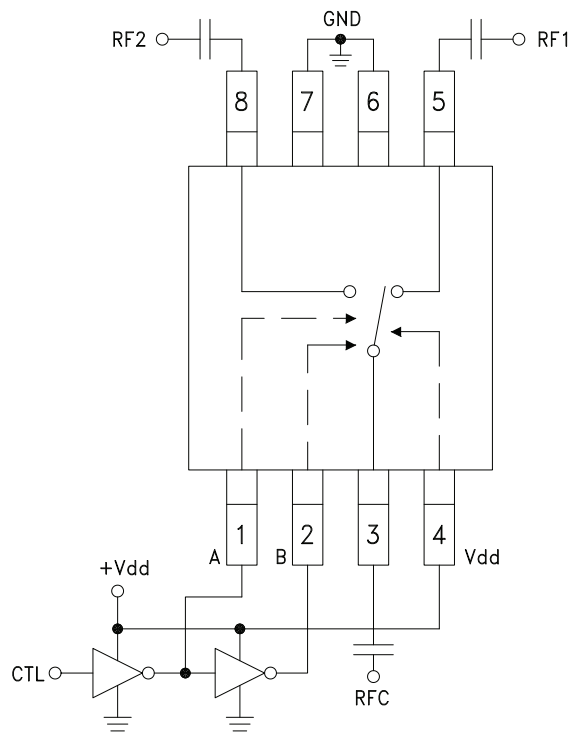

Notes:

- Set logic gate and switch Vdd:  
For Vdd = +3V to +7V, use HCT series logic to provide a TTL driver interface.  
For Vdd = +3V to +8V, use NXP Hex Inverter, HEF 4069UB or similar.
- Control inputs A/B can be driven directly with CMOS logic with Vdd of +3 to +8 Volts applied to the CMOS logic gates and to pin 4 of the RF switch.
- DC Blocking capacitors are required for each RF port as shown. Capacitor value determines lowest frequency of operation.
- Highest RF signal power capability is achieved with V set to +8V. The switch will operate properly (but at lower RF power capability) at bias voltages down to +3V.

**GaAs MMIC 10 WATT T/R SWITCH  
DC - 4 GHz**

**Evaluation Circuit Board**

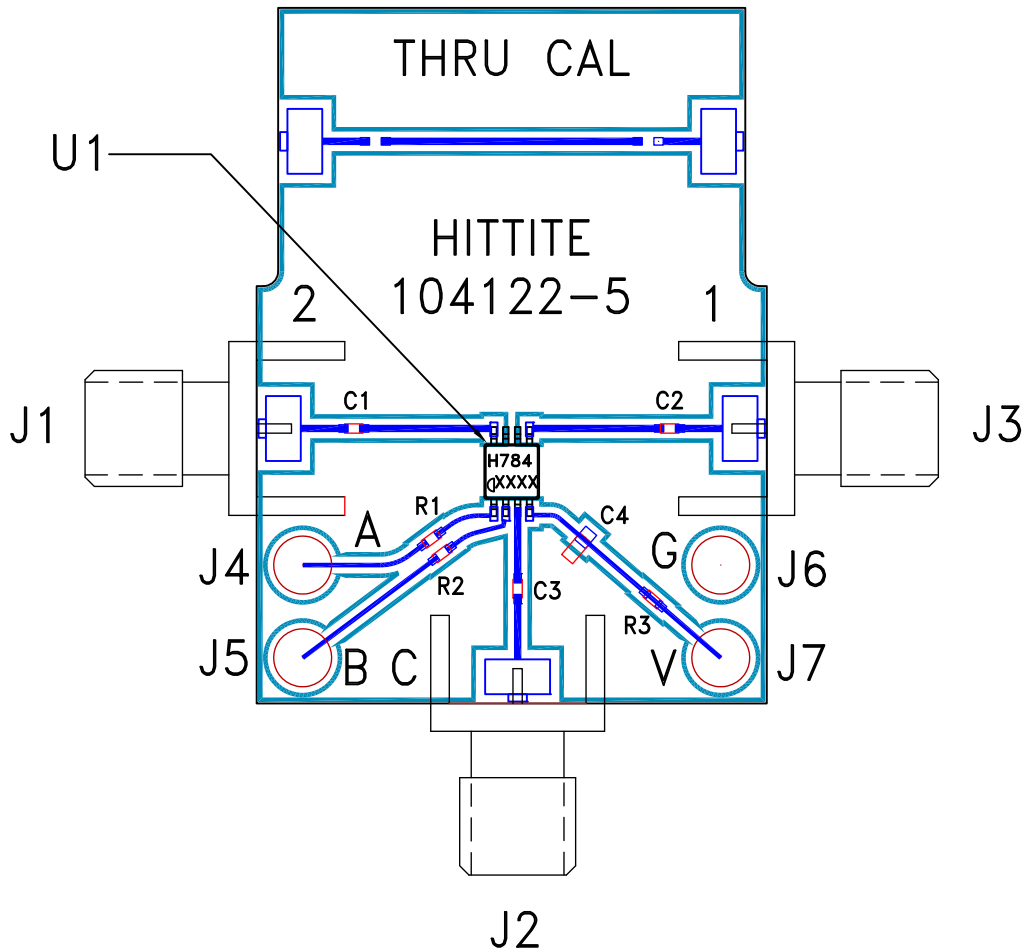

**List of Materials for Evaluation EV1HMC784AMS8G [1]**

Item	Description
J1 - J3	PCB Mount SMA RF Connector
J4 - J7	DC Pin
C1 - C3	100 pF capacitor, 0402 Pkg.
C4	10 KpF capacitor, 0603 Pkg.
R1 - R3	100 Ohm Resistor, 0402 Pkg.
U1	HMC784AMS8GE T/R Switch
PCB [2]	104122 Evaluation PCB



[1] Reference this number when ordering complete evaluation PCB

[2] Circuit Board Material: Rogers 4350

The circuit board used in the final application should be generated with proper RF circuit design techniques. Signal lines at the RF port should have 50 Ohm impedance and the package ground leads and package bottom should be connected directly to the ground plane similar to that shown above. The evaluation circuit board shown above is available from Analog Devices Inc. upon request.

## Looking for pricing, stock, or lifecycle information?

Click below to explore more details on WIN SOURCE:

-  [View HMC784AMS8GETR on WIN SOURCE](#)
-  [Analog Devices Inc. Information](#)

## Optimize Your Supply Chain with WIN SOURCE Solutions

-  Global Sourcing Solution
-  Obsolete Management
-  Cost Control Management
-  Shortage Management
-  Alternative Solution
-  Excess Inventory Management