



**THE DATASHEET OF
ECS-3953M-500-BN-TR**



The ECS-3951M-BN (5V) and ECS-3953M-BN (3.3V) Industrial Grade (-40 ~ 85°C) miniature SMD oscillators. Ideal for today's high temperature range applications.

Request a Sample

OPERATING CONDITIONS / ELECTRICAL CHARACTERISTICS

ECS-3951M/3953M-BN

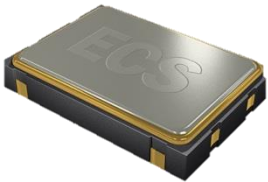

- -40 ~ +85°C Temp Range
- 5 x 7 mm footprint
- ±50 ppm Stability
- PbFree/RoHS Compliant

Parameters	Conditions	ECS-3951M-BN (5V)			ECS-3953M-BN (3.3V)*			Units
		MIN	TYP	MAX	MIN	TYP	MAX	
Frequency Range		1.800		125.0	1.800		125.0	MHz
Operating Temperature	Option (N)	-40		+85	-40		+85	°C
Storage Temperature		-55		+125	-55		+125	°C
Supply Voltage	VDD	+4.5	+5.0	+5.5	+2.97	+3.3	+3.63	V DC
Frequency Stability*	Option (B)			±50			±50	PPM
Input Current	1.800 ~ 36.000 MHz			20			15	mA
	36.100 ~ 70.000 MHz			55			25	mA
	70.100 ~ 100.000 MHz			60			30	mA
	100.100 ~ 125.000 MHz			65			35	mA
Output Symmetry	@ 50% VDD Level			40/60			40/60	%
	@ 50% VDD Level (T Option)			45/55			45/55	%
Rise and Fall Times	1.800 ~ 70.000 MHz			15			5	nS
	70.100 ~ 125.000 MHz			5			5	nS
Logic "0" Level	VOL			10% VDD			10% VDD	VDC
Logic "1" Level	VOH	90% VDD			90% VDD			VDC
Output Load	HCMOS			30			15	pF
Start-Up Time	1.800 ~ 36.000 MHz			5			5	mS
	36.100 ~ 70.000 MHz			10			10	mS
	70.100 ~ 100.000 MHz			15			15	mS
Disable Delay Time				100			100	nS

*ECS-3953M-BN is also compatible with a supply voltage +3.0V DC ±0.3V

* Note: Inclusive of 25°C tolerance, operating temperature range, input voltage change, load change, aging shock and vibration.

Part Numbering Guide: Example ECS-3953M-200-BN-TR

ECS - Series - Frequency Abbreviation - Stability Tolerance - Temperature - Output Symmetry - Packaging

ECS

3951M +5V
3953M +3.3V

200 = 20 MHz

B = ±50 ppm

N = -40 ~ +85°C

Blank = 40/60
T = 45/55

TR = Tape & Reel
1K/Reel

Package Dimensions (mm)

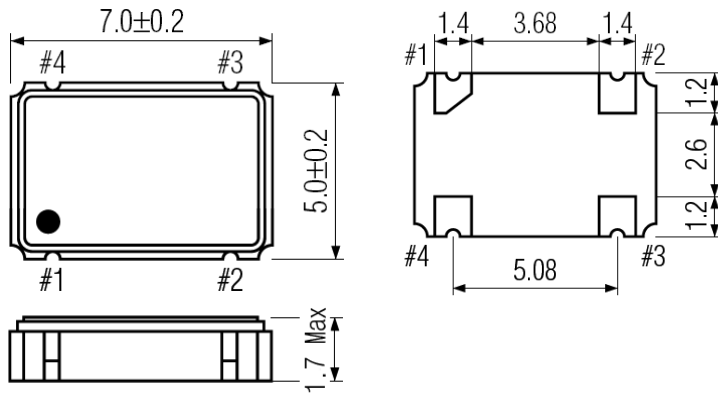

Figure 1) Top, Side, and Bottom views

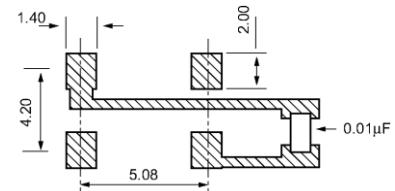

Figure 2) Suggested Land Pattern

Note: Tolerance ± 0.2 mm unless otherwise specified



Pin Connections	
#1	Tri-State
#2	Ground
#3	Output
#4	VDD

Tri-State Control Voltage	
Pad 1	Pad 3
Open	Oscillation
+2.2V Min	Oscillation
+0.8V Max	No Oscillation

Note: Internal crystal oscillation to be halted (Pin #1=VIL)

Looking for pricing, stock, or lifecycle information?

Click below to explore more details on WIN SOURCE:

-  [View ECS-3953M-500-BN-TR on WIN SOURCE](#)
-  [ECS Inc. Information](#)

Optimize Your Supply Chain with WIN SOURCE Solutions

-  Global Sourcing Solution
-  Obsolete Management
-  Cost Control Management
-  Shortage Management
-  Alternative Solution
-  Excess Inventory Management