



THE DATASHEET OF EVP-AWBD2A



3.0 mm×2.0 mm SMD Light Touch Switches

Type: **EVPAW**



■ Features

- External dimensions : 3.0 mm×2.0 mm, Height 0.6 mm
- High operability
Equipped with an actuator (push plate)
- IP67 characteristic

■ Recommended Applications

- Operation switches for portable electronic equipment
(Mobile phone, Portable audio)

■ Explanation of Part Numbers

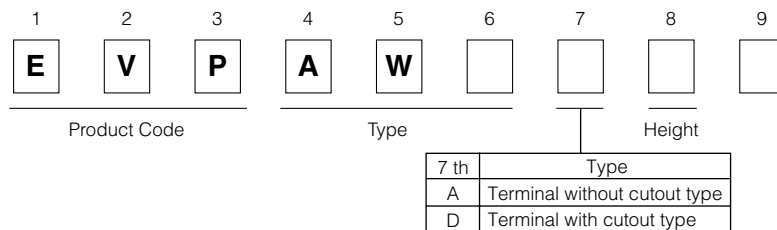

■ Specifications

Type		Snap action/Push-on type SPST
Electrical	Rating	10 μ A 2 Vdc to 20 mA 15 Vdc (Resistive load)
	Contact Resistance	500 m Ω max.
	Insulation Resistance	50 M Ω min. (at 100 Vdc)
	Dielectric Withstanding Voltage	250 Vac for 1 minute
	Bouncing	10 ms max. (ON, OFF)
Mechanical	Operating Force	1.6 N, 2.4 N, 3.3 N
	Travel	1.6 N, 2.4 N : 0.13 mm 3.3 N : 0.15 mm
Endurance	Operating Life	1.6 N, 2.4 N : 500000 cycles min. 3.3 N : 300000 cycles min.
IP67(*1)	IP6x (Dust resistance)	Dust : Talc (Type4) 8h
	IPx7 (Water resistance)	Immersion depth : 1 m 30 min.
Operating Temperature		-40 °C to +85 °C
Storage Temperature		-40 °C to +85 °C (Bulk) -20 °C to +60 °C (Taping)
Minimum Quantity/Packing Unit		10000 pcs. Embossed Taping (Reel Pack)
Quantity/Carton		50000 pcs.

Note: Non washable

(*1) IP67 : Switch shall not be operated during test.

Water or dust ingress shall be limited enough to prevent deleterious effect to the switch function.

However, IP67 shall be guaranteed under single product state,

then there is a possibility that IP67 performance become impaired depending on your mounting condition or usage.

So, please ask us in advance, if the switch is applied to important usage for water and dust resistant.

■ Dimensions in mm (not to scale)

EVPAW

(Embossed Taping)
Terminal without cutout type



General dimension tolerance : ± 0.05
() dimensions are reference dimensions.

This reference specifications are subject to change.

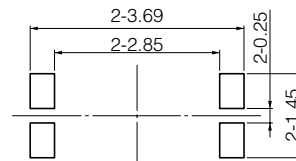
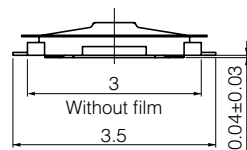
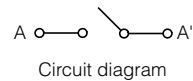
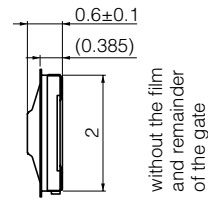
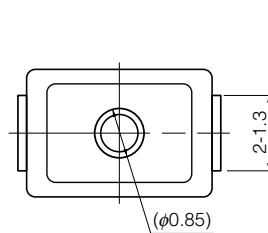

Stencil mask plan

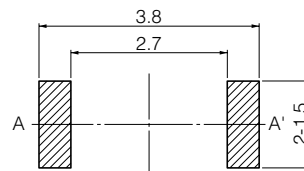
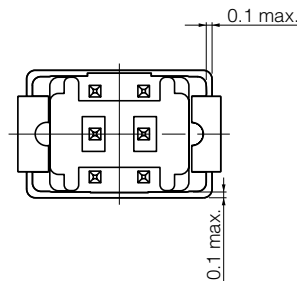

PWB land pattern for reference

Soldering thickness $t=0.08\pm0.01$

*Soldering failure may occur depending on applied solder amount, so, please consider to use our recommended stencil and land pattern desing.

Part Numbers	Operating Force	Height	Operating Life
EVPAWBA2A	1.6 N	0.6 mm	500000 cycles
EVPAWCA2A	2.4 N	0.6 mm	500000 cycles
EVPAWEA2A	3.3 N	0.6 mm	300000 cycles

■ Dimensions in mm (not to scale)

EVPAW

(Embossed Taping)
Terminal with cutout type

General dimension tolerance : ± 0.05
() dimensions are reference dimensions.

This reference specifications are subject to change.

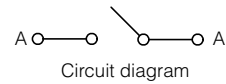
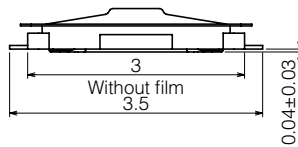
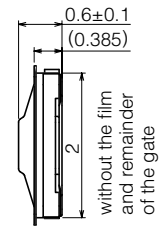
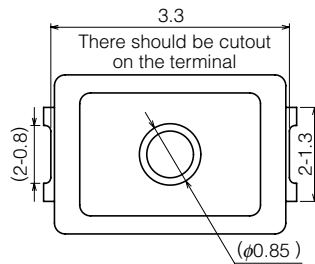

The thickness of the solder stencil shall be 0.1 mm, and the opening ratio of the solder stencil to a land pattern shall be 60 to 100 % (recommend 80 %.)

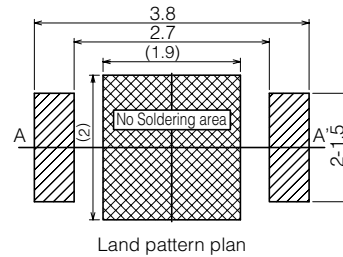
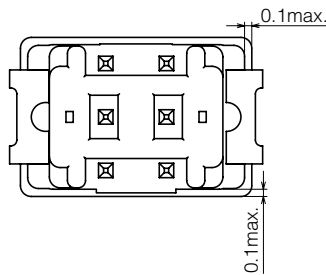

* Soldering failure may occur depending on applied solder amount, so, please consider to use our recommended stencil and land pattern desing.

▨ : Recommended land pattern area
▩ : No soldering area

- Any land pattern or via holes shall not be provided at ▩ area.
- If it's necessary to design land pattern or via holes at ▩ area, please apply resist to them to protect their metal part completely.
- If their metal parts are not protected completely, short circuit failure may occur.
- Besides, there should be convexoconcave by designing additional pattern, it may cause switch tilt, influence on solder-ability or flux intrusion after reflow soldering.
- Therefore, please study any influence of addition land pattern or via holes at ▩ area in advance.

Part Numbers	Operating Force	Height	Operating Life
EVPAWBD4A	1.6 N	0.6 mm	500000 cycles
EVPAWCD4A	2.4 N	0.6 mm	500000 cycles
EVPAWED4A	3.3 N	0.6 mm	300000 cycles

■ Recommended Reflow Soldering Conditions

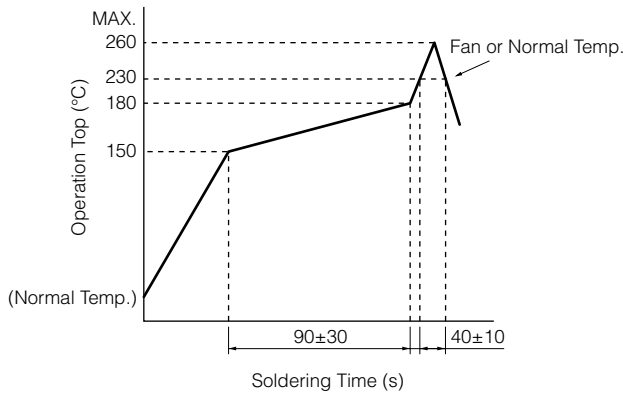

*Reflow temperature may vary by location even in the same reflow condition. Please check the reflow temperature at terminals and at the top of a switch to make sure the both temperatures are within the specification. If even one of them is out of the specifications, please adjust.

● Embossed Carrier Taping

Tape width=12.0 mm

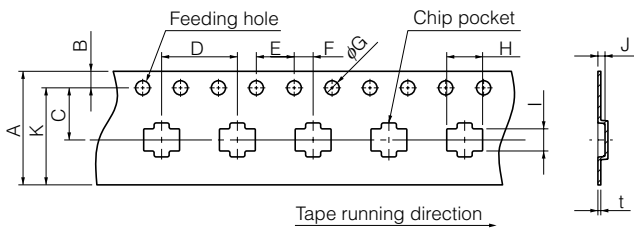

Taping condition : Lack of products in the middle of taping should be one MAX, but total quantity specified in the specifications should be secured.
Peeling off strength of top tape : It should be within 0.2N to 1.0N at 165 degree in peeling off angle.
Joint of carrier tape : One joint per one reel may exist.

Unit: mm

Part No.	Height	A	B	C	D	E	F	G	H	I	J	K	t
EVPAW	0.6	12.0±0.3	1.75±0.10	5.5±0.1	8.0±0.1	4.0±0.1	2.0±0.1	1.5±0.3	3.8±0.2	2.3±0.2	0.75±0.20	(10.25)	0.3 ^{+0.15} _{-0.10}

● Standard Reel Dimensions in mm (not to scale)

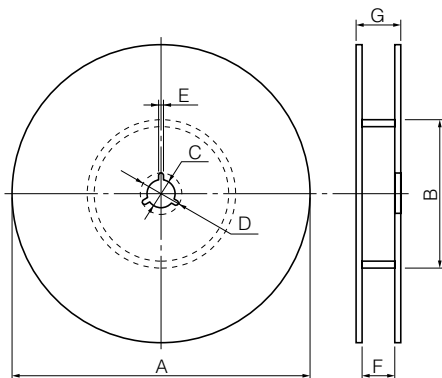

Item	A	B	C	D	E
Rate (mm)	φ380.0±2.0	φ80.0±1.0	φ13.0±0.5	φ21.0±1.0	2.0±0.5

Item	F	G
Rate (mm)	13.5±1.0	17.5±1.0

Looking for pricing, stock, or lifecycle information?

Click below to explore more details on WIN SOURCE:

- ⊖ [View EVP-AWBD2A on WIN SOURCE](#)
- ⊖ [Panasonic Information](#)

Optimize Your Supply Chain with WIN SOURCE Solutions

- ✓ Global Sourcing Solution
- ✓ Obsolete Management
- ✓ Cost Control Management
- ✓ Shortage Management
- ✓ Alternative Solution
- ✓ Excess Inventory Management