



**THE DATASHEET OF
AB-RTCMC-32.768KHZ-AIGZ-S7-T**



Real Time Clock Module with I²C Bus

AB-RTCMC-32.768kHz-AIGZ-S7



RoHS/RoHS II compliant

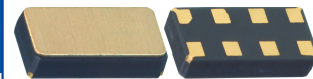

3.2 x 1.5 x 0.8 mm

Moisture Sensitivity Level: MSL=1

FEATURES:

- RTC module with built-in crystal oscillating at 32.768 kHz
- 350 nA timekeeping current at 3 V
- Timekeeping down to 1.0 V
- 1.3 V to 4.4 V I2C bus operating voltage
- Low operating current of 35 μ A (at 400 kHz)
- 32.768kHz square wave on power-up to drive a microcontroller in low-power mode– Programmable from 1 Hz to 32.768kHz;– Can be disabled
- 400 kHz I2C serial interface
- Oscillator stop detection circuit monitors clock operation
- Accurate programmable watchdog– 62.5 ms to 31 min timeout
- Counters for tenths/hundredths of seconds, seconds, minutes, hours, day, date, month, year, and century
- Software clock calibration to compensate deviation of crystal due to temperature
- Automatic leap year compensation
- Ultra-small, 3.2 x 1.5 mm, lead-free 8-pin ceramic leadless chip carrier

APPLICATIONS:

- Wide range in communication & measuring equipment
- Commercial & Industrial applications
- Automotive electronics applications
- Wireless communications
- PDA and Palm Pilots
- Credit Cards with Security Technology

STANDARD SPECIFICATIONS:

Absolute Maximum Ratings

In accordance with the Absolute Maximum Rating System IEC 60134

Parameters	Symbol	Conditions	Min.	Max.	Units
Supply Voltage	V _{DD}	>GND / <V _{DD}	GND-0.3	+5.0	V
Input Voltage	V _I		GND-0.2	V _{DD} +0.3	V
Output Voltage	V _O		GND-0.2	V _{DD} +0.3	V
Output Current	I _O			20	mA
Power Dissipation	P _D			1	W
Operating Ambient Temperature Range	T _{OPR}		-40	+85	°C
Storage Temperature Range	T _{STO}	Stored as bare product	-55	+125	°C
Electro Static Discharge Voltage	V _{ESD}	HBM ¹⁾ T _A = 25°C MM ²⁾ T _A = 25°C		>1500 >1000	V

1) HBM: Human Body Model, according to JESD22-A114.

2) MM: Machine Model, according to JESD22-A115.

These data are based on characterization results, not tested in production. Stresses above these listed maximum ratings may cause permanent damage to the device. Exposure beyond specified operating conditions may affect device reliability or cause malfunction.

Operating and AC Measurement Conditions ¹⁾

Parameters	Symbol	Min.	Max.	Units
Supply Voltage	V _{DD}	1.3	4.4	V
Operating Ambient Temperature	T _A	-40	+85	°C
Load Capacitance	C _L		50	pF
Input Rise and Fall Times			5	ns
Input Pulse Voltages		0.2*V _{DD}	0.8*V _{DD}	V
Input and Output timing ref. Voltage		0.3*V _{DD}	0.7*V _{DD}	V

1) Output Hi-Z is defined as the point where data is no longer driven.

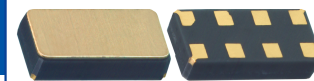

Capacitance

Parameters ¹⁾²⁾	Symbol	Min.	Max.	Units
Input Capacitance	C _{IN}		7	pF
Output Capacitance	C _{OUT} ³⁾		10	pF
Low-pass filter input time constant (SDA and SCL)	t _{LP}		50	ns

1) Effective capacitance measured with power supply at 3.6 V; sampled only, not 100% tested.

2) At 25°C, f = 1MHz.

3) Outputs deselected.

Frequency Characteristics

T_{amb} = +25°C; f_{OSC} = 32.768 kHz

Parameters	Symbol	Conditions	Min.	Max.	Units	
Frequency Accuracy	Δf/f	T _{amb} = +25°C	-20	+20	ppm	
Frequency vs. Temperature Characteristics	Δf/T _{OPR}	T _{OPR} = -40 to +85°C	-0.035 ^{ppm/°C} * (T _{OPR} - T ₀) ² (±10%)		ppm	
Turnover Temperature	T _O		+20	+25	+30	°C
Aging (first year)	Δf/f	T _{amb} = +25°C	-3	+3	ppm	
Oscillator Start-up Voltage	V _{Start}	≤10 seconds	1.5		V	
Oscillator Start-up Time	T _{Start}	V _{DD} = 3.0V		1	s	
CLKOUT Duty Cycle		F _{CLKOUT} = 32.768kHz T _{amb} = +25°C	40	50	60	%

FREQUENCY VS. TEMPERATURE CHARACTERISTICS

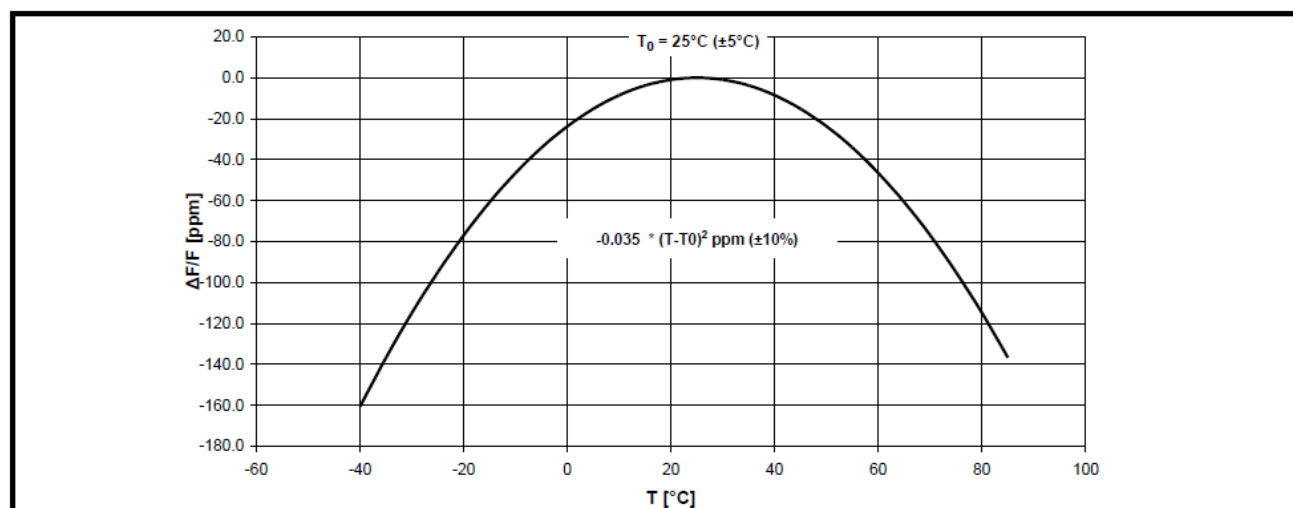

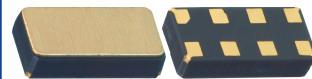

Static Characteristics

Valid for T_{amb} = -40°C to +85°C; V_{DD} = 1.3 V to 4.4 V (except where noted)

Parameters	Symbol	Conditions	Min.	Typ.	Max.	Units
Supply Voltage	V _{DD} ¹⁾	Clock	1.0		4.4	V
		I ² C Bus (400kHz)	1.3		4.4	V
Supply Current SCL=400kHz No Load	I _{DD1}	V _{DD} = 4.4V			100	μA
		V _{DD} = 3.6V		50	70	μA
		V _{DD} = 3.0V		35		μA
		V _{DD} = 2.5V		30		μA
		V _{DD} = 2.0V		20		μA
Supply Current (standby) SCL = 0Hz; CLKOUT off All inputs ≥V _{DD} -0.2V ≤V _{SS} +0.2V	I _{DD2}	V _{DD} = 4.4V			950	nA
		V _{DD} = 3.6V		375	700	nA
		V _{DD} = 3.0V at 25°C		350	500	nA
		V _{DD} = 2.0V at 25°C		310	450	nA
		V _{DD} = 1.0V at 25°C		270	400	nA
LOW Level Input Voltage	V _{IL}		-0.2		0.3*V _{DD}	V
HIGH Level Input Voltage	V _{IH}		0.7*V _{DD}		V _{DD} +0.3	V
HIGH Level Output Voltage	V _{OH}	V _{DD} =4.4V, I _{OH} = -1.0mA (push-pull)	2.4			V
LOW Level Output Voltage	V _{OL}	V _{DD} =4.4V, I _{OL} = 3.0mA (SDA)			0.4	V
		V _{CC} =4.4V, I _{OL} = 1.0mA (SQW, $\overline{\text{INT}}$)			0.4	
Pull-up Supply voltage (open drain)		$\overline{\text{INT}}$			4.4	V
Input Leakage Current	I _{LI}	0V ≤ V _{IN} ≤ V _{DD}	-1		+1	μA
Output Leakage Current	I _{LO}	0V ≤ V _{OUT} ≤ V _{DD}	-1		+1	μA

1. Oscillator startup guaranteed down to 1.5 V only.

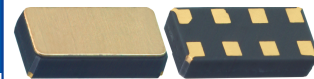

I²C Interface Dynamic Characteristics

Valid for T_{amb}= -40°C to +85°C; V_{DD}= 1.3 V to 4.4 V (except where noted)

Parameters	Symbol	Min.	Typ.	Max.	Units
SCL Clock Frequency	f _{SCL}	0		400	kHz
START Condition Setup Time (only relevant for a repeated start condition)	t _{SU:STA}	600			ns
START Condition Hold Time (after this period the first clock pulse is generated)	t _{HD:STA}	600			ns
Data Setup Time ¹⁾	t _{SU:DAT}	100			ns
Data Hold Time	t _{HD:DAT}	0			μs
STOP Condition Setup Time	t _{SU:STO}	600			ns
Bus Free Time between STOP and START condition	t _{BUF}	1.3			μs
SCL “LOW time”	t _{LOW}	1.3			μs
SCL “HIGH time”	t _{HIGH}	600			ns
SCL and SDA Rise Time	t _R			300	ns
SCL and SDA Fall Time	t _F			300	ns
Watchdog Output Pulse Width	t _{REC}	96		98	ms

1. Transmitter must internally provide a hold time to bridge the undefined region (300 ns max) of the falling edge of SCL.

I²C Interface Timing Characteristics

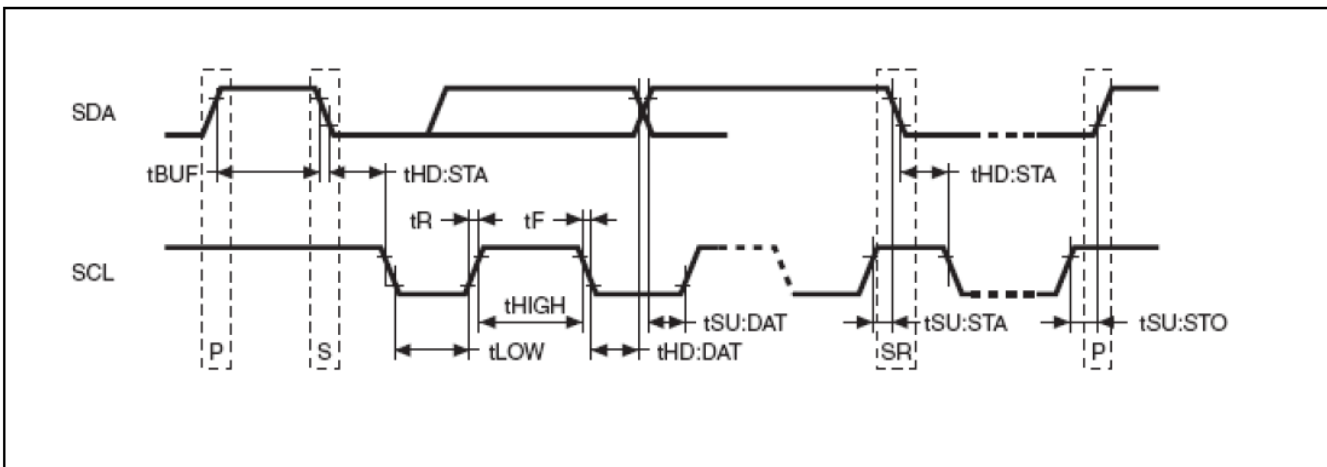

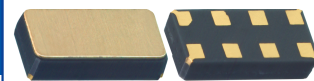

PART IDENTIFICATIONS:

AB-RTCMC-32.768 kHz-AIGZ-S7-



Packaging

Blank: Bulk

T: 1000pcs/reel

OUTLINE DIMENSIONS:

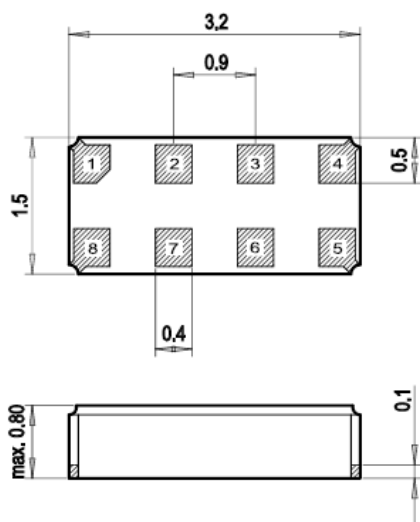

Recommended Land Pattern

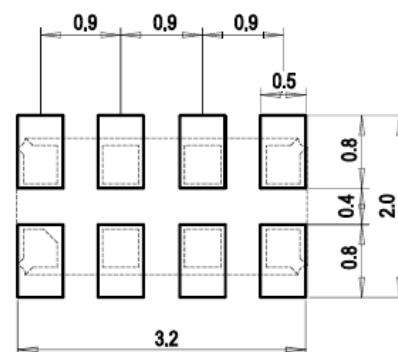

Dimensions: mm

PIN DESCRIPTIONS:

Pin No.	Pin Name	Function
1	SDA	Serial data; open-drain; requires pull-up resistor
2	CLKOUT	Clock Output
3	V _{SS}	Ground
4	NC	Not connected
5	V _{DD}	Power Supply voltage
6	$\overline{\text{INT}}$	Interrupt output; open-drain; requires pull-up resistor; active low
7	NC	Not connected
8	SCL	Serial clock input; requires pull-up resistor

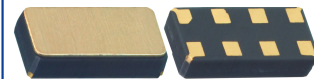

BLOCK DIAGRAM:

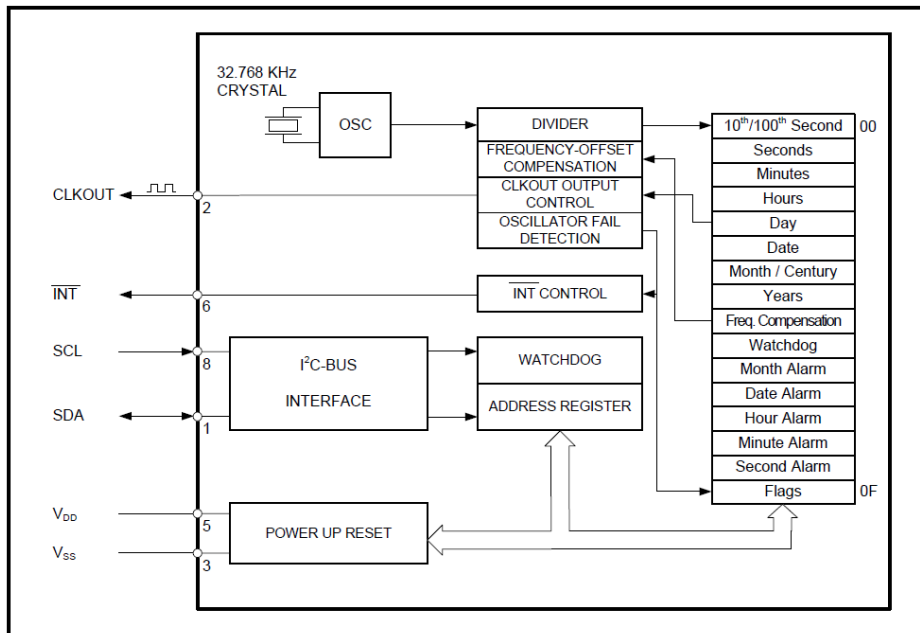

RECOMMENDED REFLOW PROFILE:

Maximum Reflow Conditions in accordance with IPC/JEDEC J-STD-020C “Pb-free”

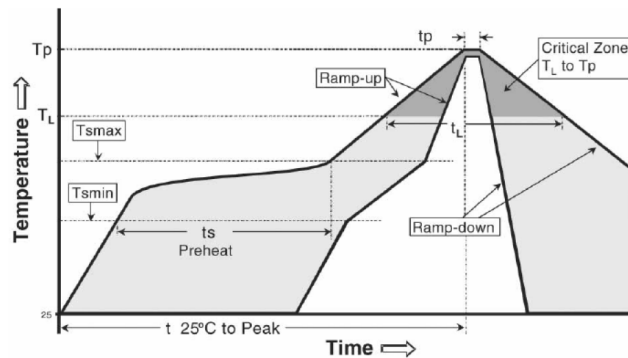

Temperature	Conditions	Units
Average Ramp-up Rate (T _{smax} to T _p)	3°C/second max	°C/s
Ramp Down Rate (T _{cool})	6°C/second max	°C/s
Time 25°C to Peak Temperature (T _{to-peak})	8 minutes max	m
Preheat		
Temperature Min (T _{smin})	150	°C
Temperature Max (T _{smax})	200	°C
Time T _{smin} to T _{smax} (t _s)	60 ~ 180	sec
Time Above Liquidus		
Temperature Liquidus (T _L)	217	°C
Time above Liquidus (t _L)	60 ~ 150	sec
Peak Temperature		
Peak Temperature (T _p)	260	°C
Time within 5°C of Peak Temperature (t _p)	20 ~ 40	sec

Real Time Clock Module with I²C Bus

AB-RTCMC-32.768kHz-AIGZ-S7



RoHS/RoHS II compliant

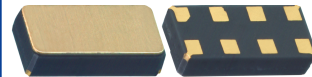

3.2 x 1.5 x 0.8 mm

TAPE & REEL:

T = 1000pcs/reel

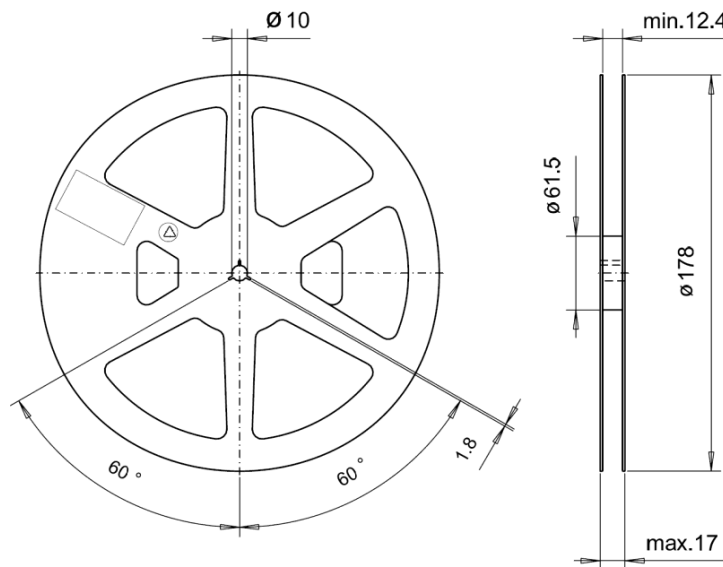
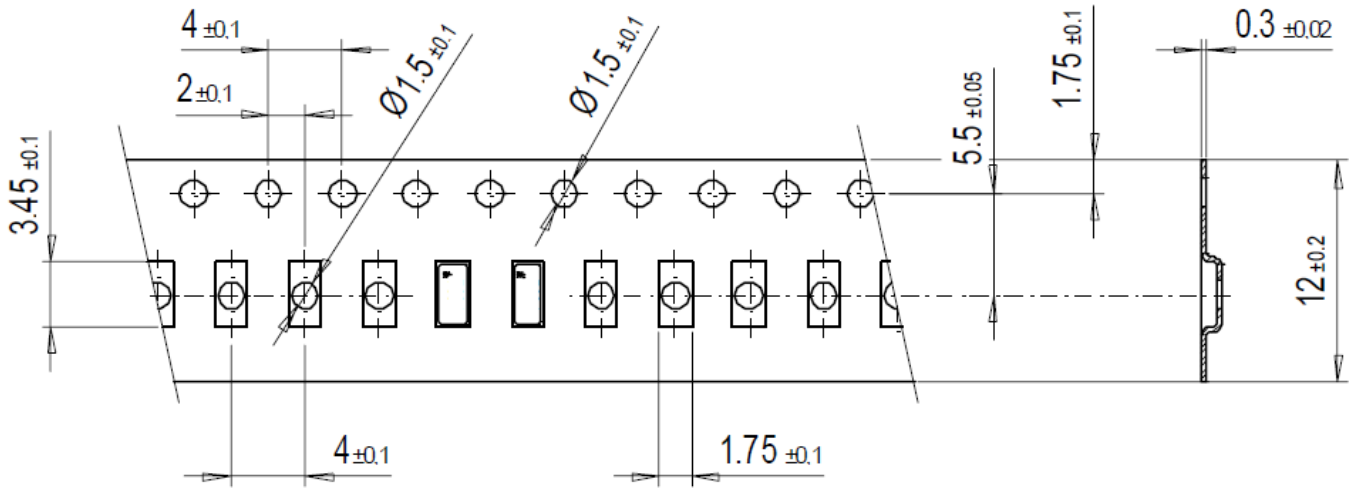

Dimension: mm

ATTENTION: Abracon LLC's products are COTS – Commercial-Off-The-Shelf products; suitable for Commercial, Industrial and, where designated, Automotive Applications. Abracon's products are not specifically designed for Military, Aviation, Aerospace, Life-dependent Medical applications or any application requiring high reliability where component failure could result in loss of life and/or property. For applications requiring high reliability and/or presenting an extreme operating environment, written consent and authorization from Abracon LLC is required. Please contact Abracon LLC for more information.

Looking for pricing, stock, or lifecycle information?

Click below to explore more details on WIN SOURCE:

 [View AB-RTCMC-32.768KHZ-AIGZ-S7-T on WIN SOURCE](#)

 [Abracon LLC Information](#)

Optimize Your Supply Chain with WIN SOURCE Solutions

-  Global Sourcing Solution
-  Obsolete Management
-  Cost Control Management
-  Shortage Management
-  Alternative Solution
-  Excess Inventory Management