

Class-AB Speaker Amplifiers

5W+5W
Stereo Speaker Amplifiers

BA5406,BA5417

No.13077EDT02

●Description

The BA5406/BA5417 is a dual OTL monolithic power IC with two built-in, high output speaker amplifier circuits. High output of 5W×2 can be produced when $V_{CC}=12\text{ V}$ and $R_L=3\Omega$, and 2.8 W×2 when $V_{CC}=9\text{ V}$ and $R_L=3\Omega$. The BA5406, which uses a high allowable power dissipation package, has a simple heatsink design. The BA5417 not only exceeds basic characteristics, but also has a built-in soft clip circuit, thermal shutdown and standby circuits.

●Features
BA5406

- 1) Good low voltage characteristics (Operation from $V_{CC}=5\text{ V}$)
- 2) Ripple filter (6pin) also can be used as muting pin (Make 6pin GND potential)
- 3) Small thermal resistance package and simple heatsink design

BA5417

- 1) Small pop noise when standby switches ON/OFF
- 2) Built-in circuit to prevent ripple addition when motor starts
- 3) Built-in thermal shutdown circuit
- 4) Built-in standby switch circuit
- 5) Built-in soft clip circuit

●Applications

Stereo radio cassette players, mini-audio systems, LCD TVs, etc.

●Line up matrix

Part No.	BA5406	BA5417	Units
Supply voltage	5 ~ 15	6 ~ 15	V
Power dissipation	20	15	W
Quiescent current	40	22	mA
Standby current	—	0	μA
Closed loop voltage gain	46	45	dB
Output noise voltage	0.6	0.3	mVrms
Total harmonic distortion	0.3	0.1	%
Ripple rejection	—	55	dB
Package	SIP-M12	HSIP15	—

●Absolute maximum ratings (Ta=25°C)

Parameter	Symbol	Ratings		Unit
		BA5406	BA5417	
Supply voltage	V _{CC}	18 ^{*1}	20 ^{*1}	V
Power dissipation	P _d	20 ^{*2}	15 ^{*3}	W
Operating temperature	T _{opr}	-20 ~ +75	-20 ~ +75	°C
Storage temperature	T _{stg}	-30 ~ +125	-55 ~ +150	°C

*1 When no signal

*2 Back metal temperature 75°C

*3 Ta=75°C (Using infinite heatsink)

●Operating range (Ta=25°C)

Parameter	Symbol	Ratings		Unit
		BA5406	BA5417	
Supply voltage	V _{CC}	5.0 ~ 15.0	6.0 ~ 15.0	V

●Electrical characteristics (BA5406 : Unless otherwise noted, Ta=25°C, V_{CC}=12V)
 (BA5417 : Unless otherwise noted, Ta=25°C, V_{CC}=9V)

Parameter	Symbol	Limits		Unit.	Conditions	
		BA5406	BA5417			
Quiescent current	I _o	40	22	mA	V _{IN} =0Vms	
Rated output power	P _{OUT}	5.0	5.0	W	THD=10%, V _{CC} =12V, R _L =3Ω	
Closed loop voltage gain	G _{VC}	46	45	dB	—	
Output noise voltage	V _{NO}	0.6	0.3	mVrms	R _g =10kΩ, DIN-Audio	
Total harmonic distortion	THD	0.3	0.1	%	P _{OUT} =0.5W, f=1kHz	
Ripple rejection	RR	—	55	dB	f _{RR} =100Hz, V _{RR} =-10dBm	
Crosstalk	CT	—	65	dB	V _O =0dBm	
Standby current	I _{OFF}	—	0	μA	—	
Standby pin input current	I _{SIN}	—	0.15	mA	V _{STBY} =V _{CC}	
Standby pin control voltage	Activated	V _{STH}	—	3.5 ~ V _{CC}	V	—
	Not Activated	V _{STL}	—	0 ~ 1.2	V	—

* Note: This IC is not designed to be radiation-resistant.

●Block diagram

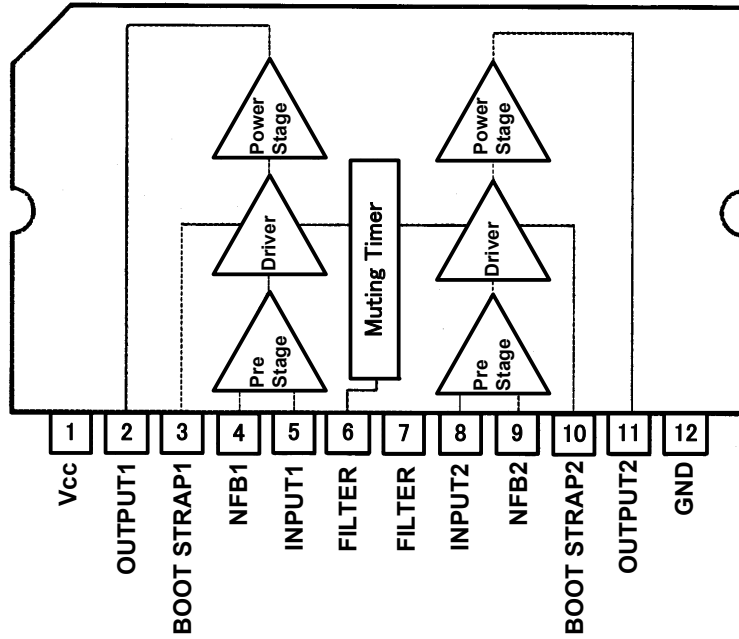

Fig.1 BA5406

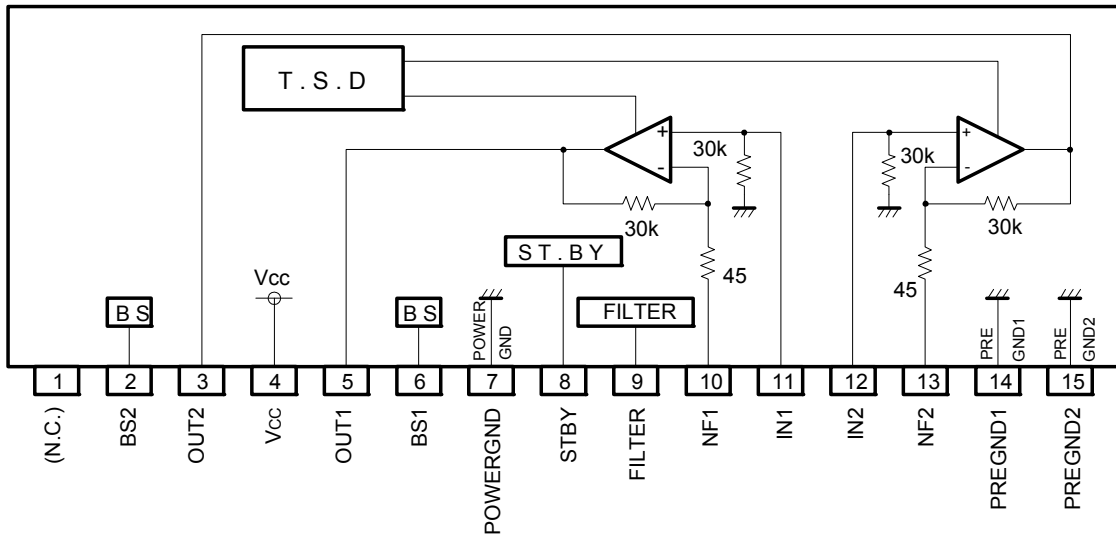

Fig.2 BA5417

● Measurement circuit

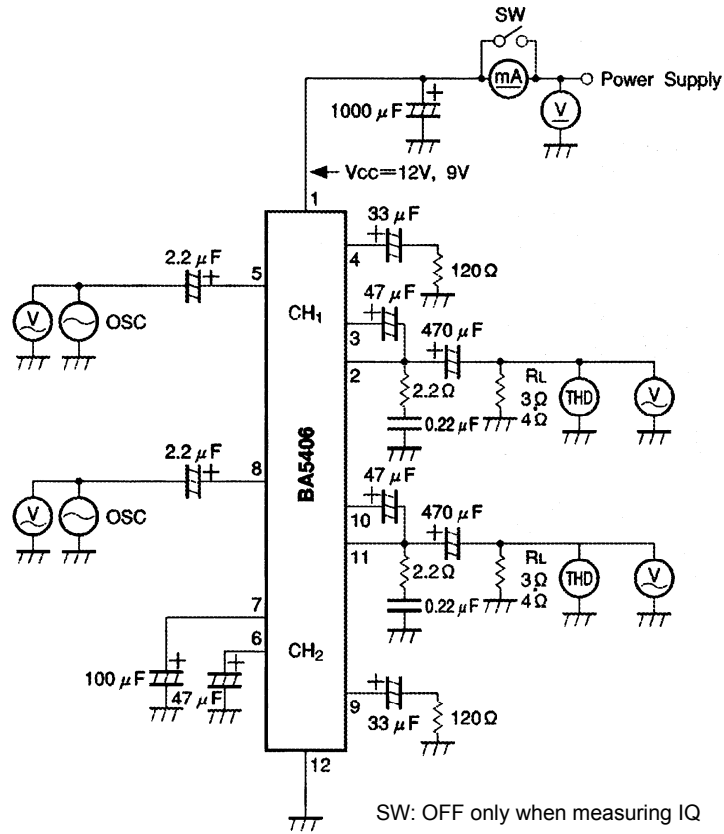

Fig.3 BA5406

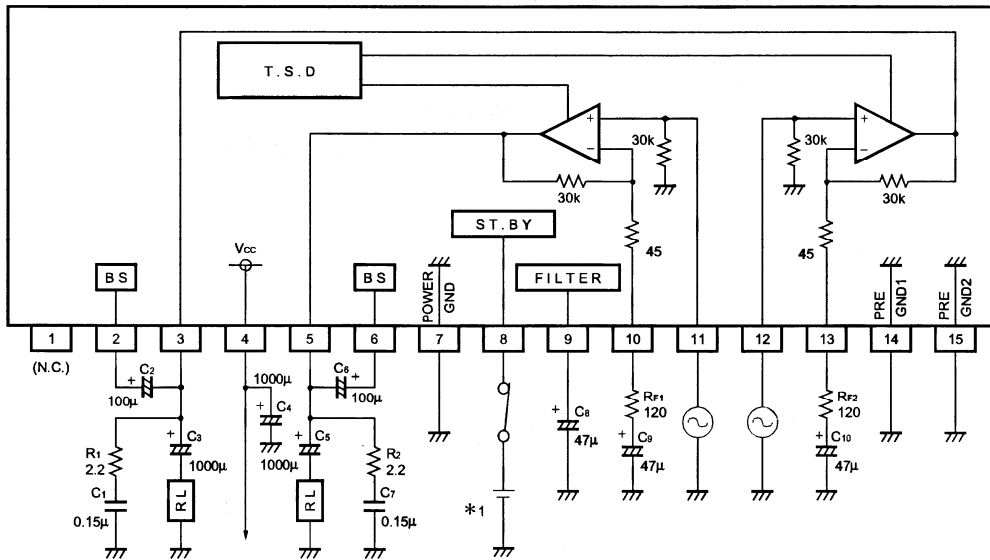

Fig.4 BA5417

●Application circuit
BA5406

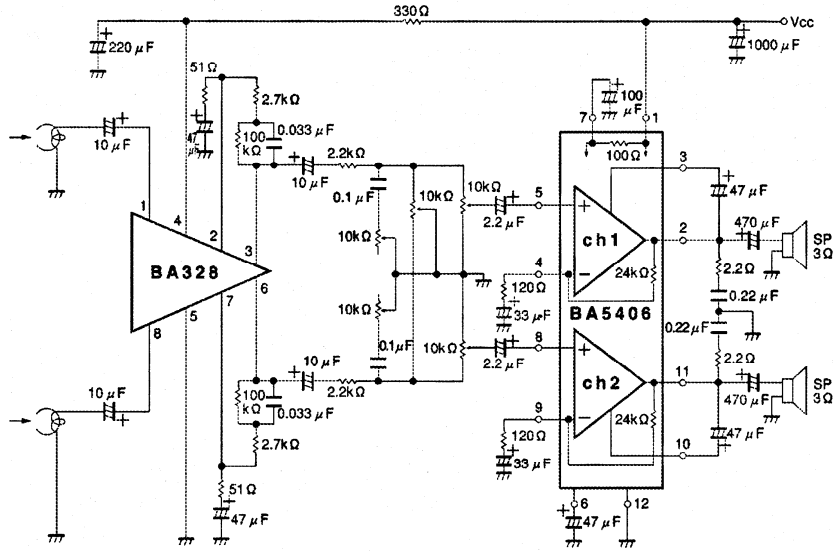

Fig.5

BA5417
OTL mode circuit

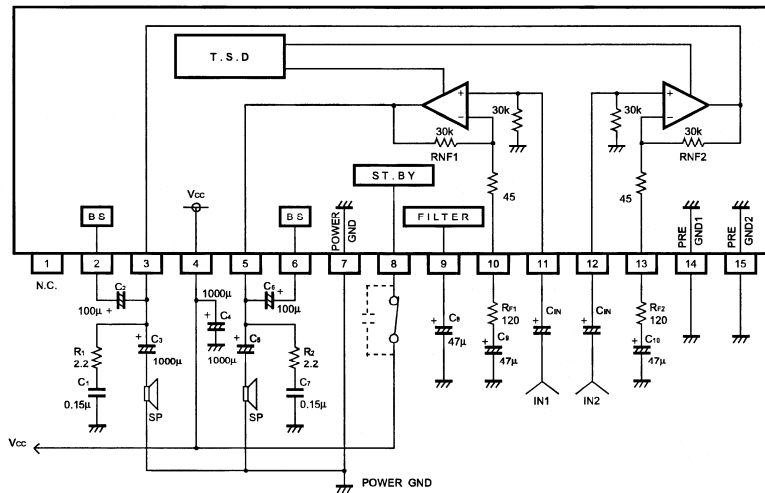

Fig.6

BTL mode circuit

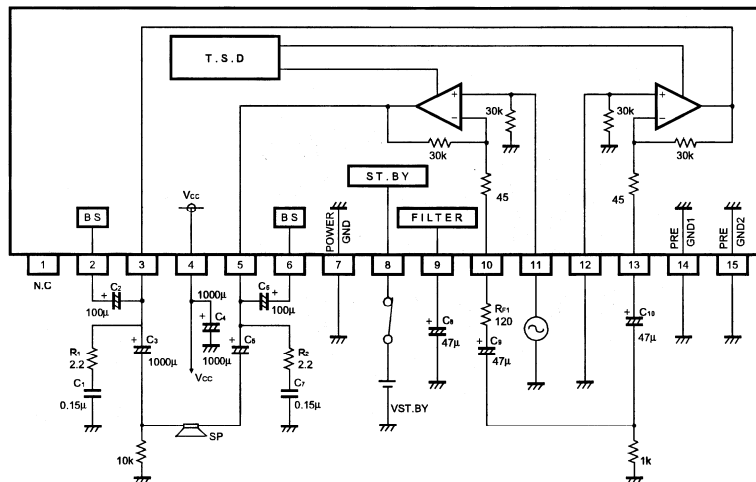

Fig.7

●Reference data

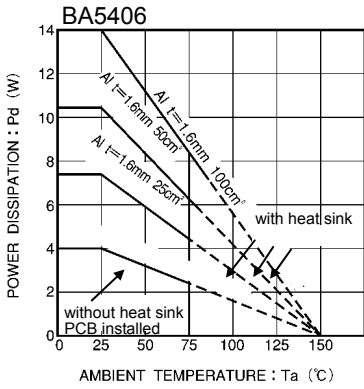

Fig.8 Thermal derating curve

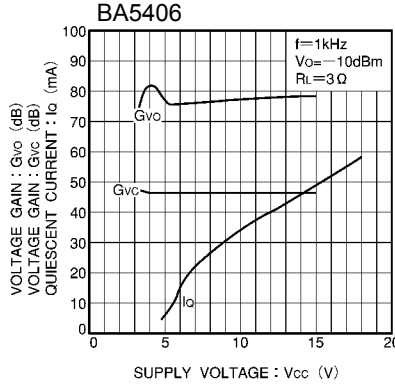

Fig.9 Quiescent current and voltage gain vs Supply voltage

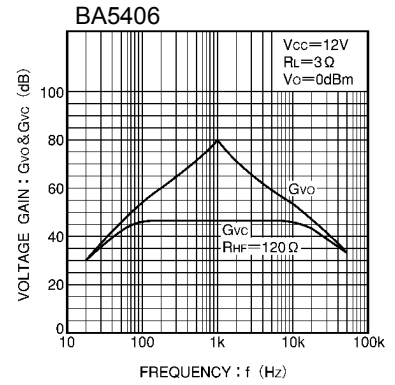

Fig.10 Voltage gain vs frequency

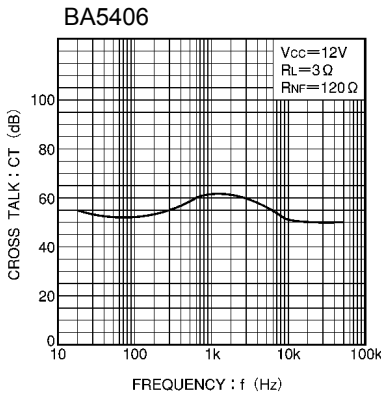

Fig.11 Crosstalk vs frequency

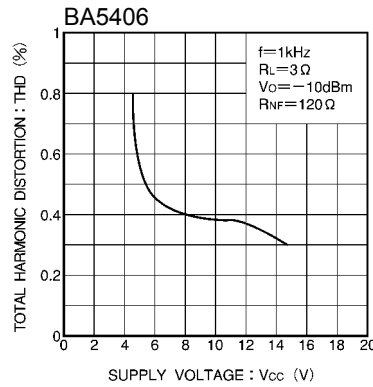

Fig.12 Distortion vs power supply voltage

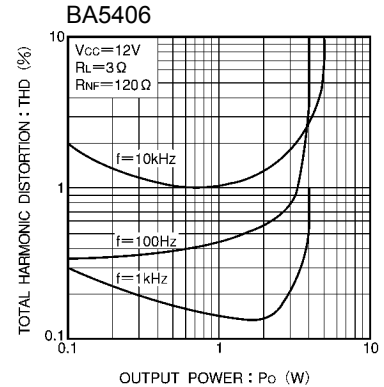

Fig.13 Distortion vs Output power

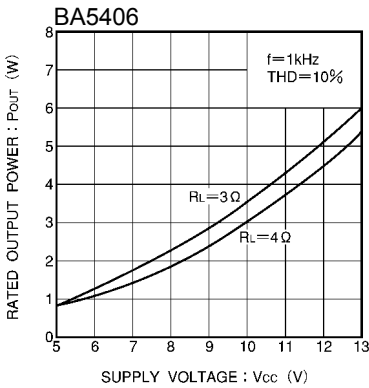

Fig.14 Output power vs power supply voltage

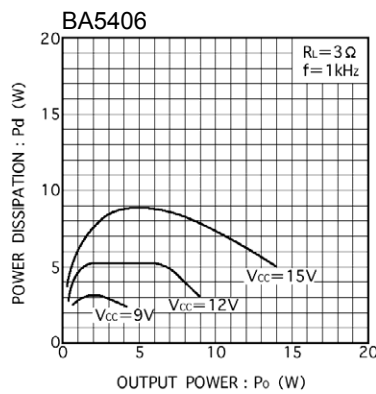

Fig.15 Power dissipation vs Output power(1)

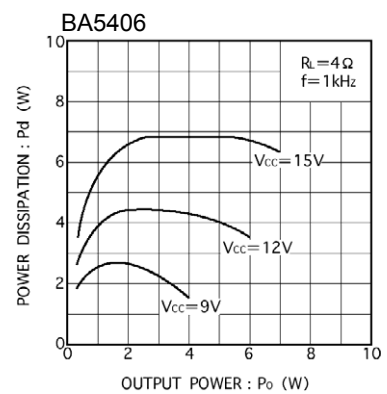

Fig.16 Power dissipation vs Output power(2)

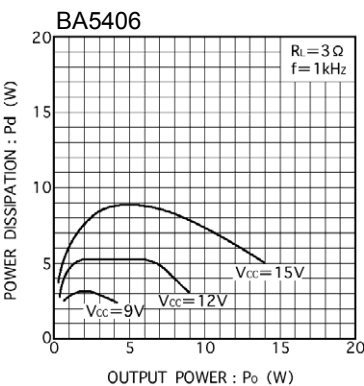

Fig.17 Power dissipation vs Output power(3)

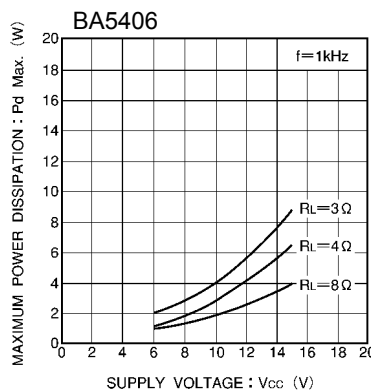

Fig.18 Maximum power dissipation vs Supply voltage

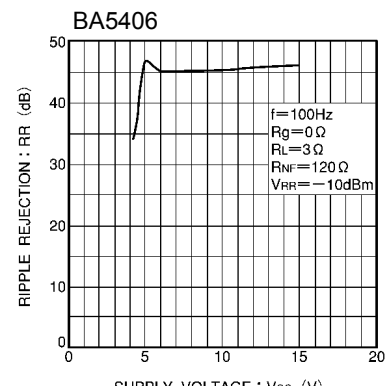

Fig.19 Ripple rejection ratio vs Supply voltage

BA5417 OTL mode

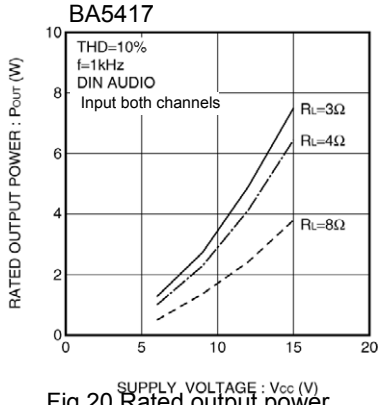

Fig.20 Rated output power vs Supply voltage

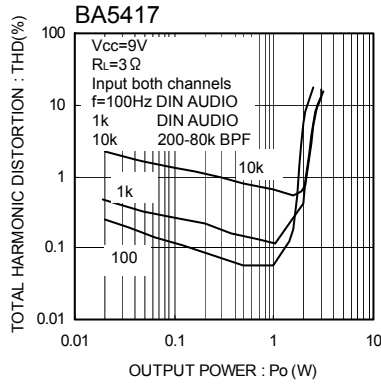

Fig.21 Total harmonic distortion vs Output power

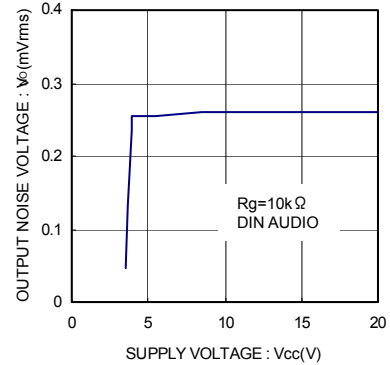

Fig.22 Output noise voltage vs Supply voltage

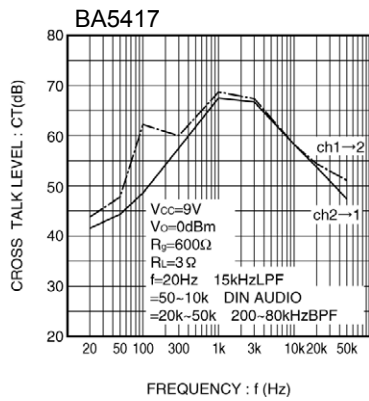

Fig.23 Crosstalk vs. Frequency

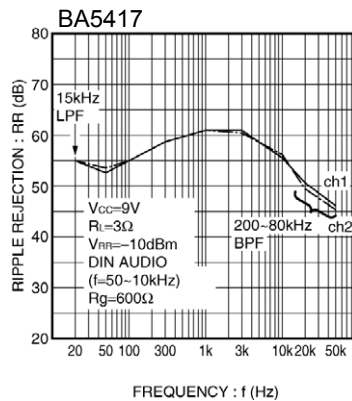

Fig.24 Ripple rejection vs. Frequency

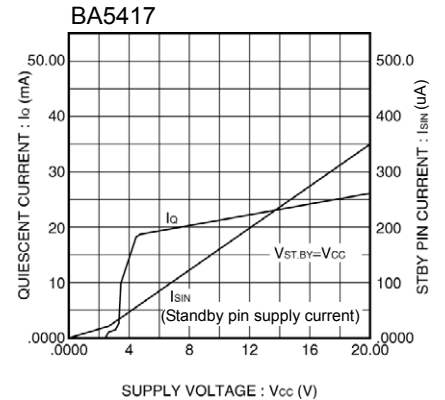

Fig.25 Quiescent, standby pin input current vs. Supply voltage

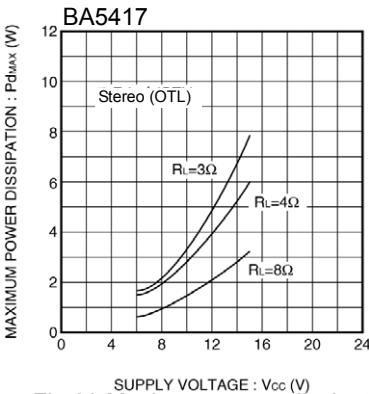

Fig.26 Maximum power dissipation vs. Supply voltage

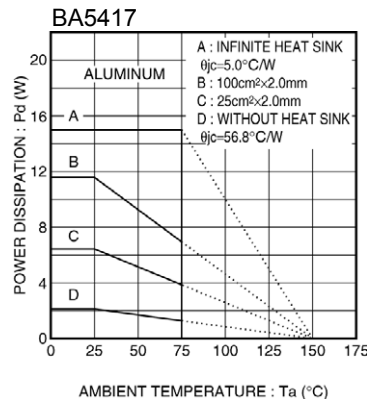

Fig.27 Thermal derating curve

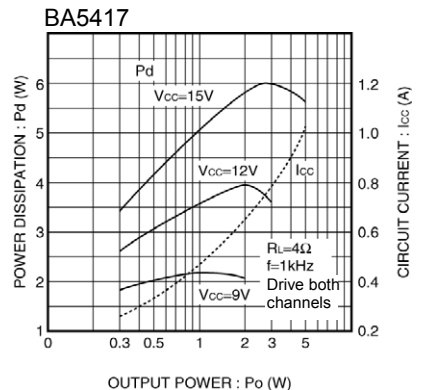

Fig.28 Power dissipation, circuit current vs. Supply Voltage (RL=4Ω)

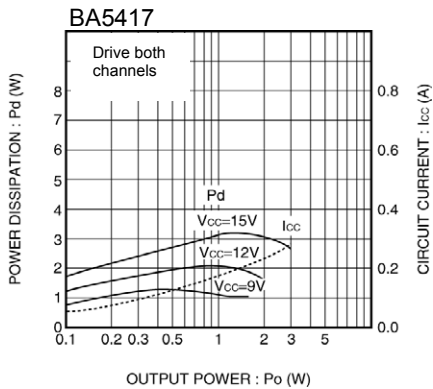

Fig.29 Power dissipation, circuit current vs. Supply Voltage (RL=8Ω)

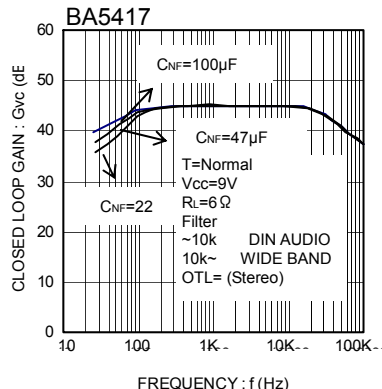

Fig.30 Closed loop gain vs. Frequency

BA5417 BTL mode

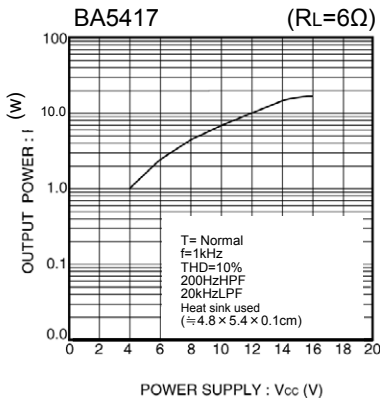

Fig.31 Rated output power vs. Supply Voltage

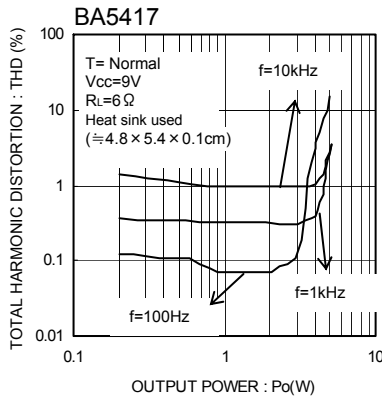

Fig.32 Total harmonic distortion vs. Output power

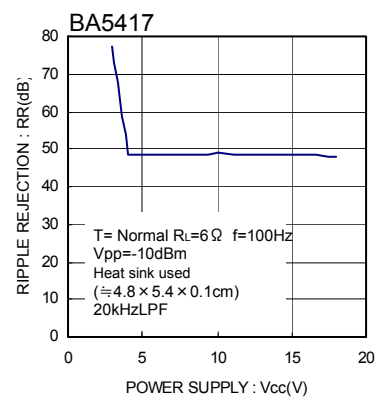

Fig.33 Ripple rejection ratio vs. Supply Voltage

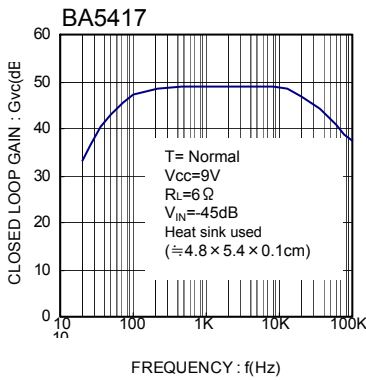

Fig.34 Close loop gain vs. Frequency

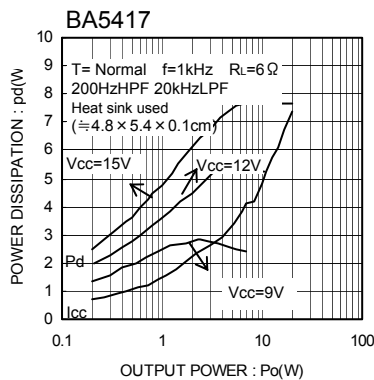

Fig.35 Power dissipation, Supply current vs. Frequency

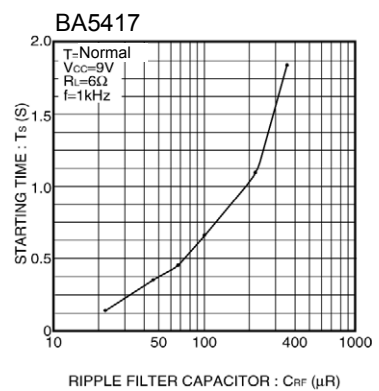

Fig.36 Starting time vs. Ripple filter capacitor

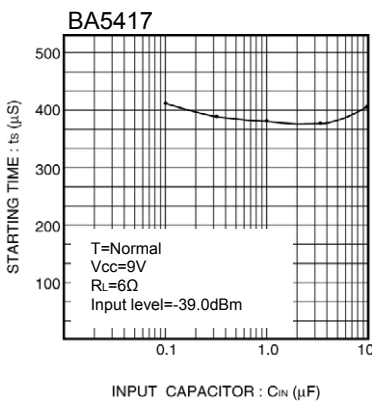

Fig.37 Starting time vs. Input coupling capacitor

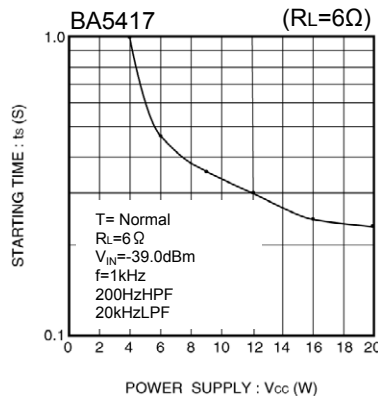

Fig.38 Starting time vs. Supply Voltage

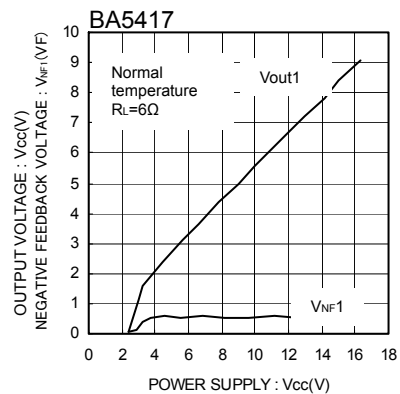

Fig.39 Output voltage, Negative feedback voltage vs. Supply Voltage

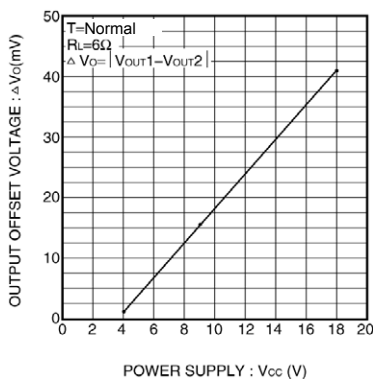

Fig.40 Output offset voltage vs. Supply Voltage

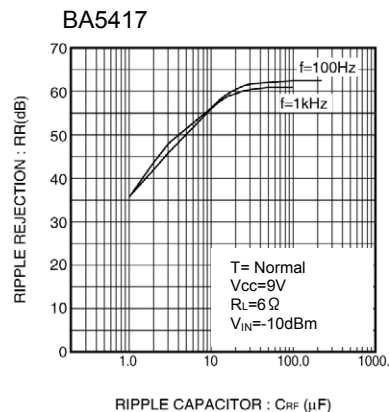

Fig.41 Ripple rejection vs. Ripple filter capacitor

●Notes for use

- 1) Numbers and data in entries are representative design values and are not guaranteed values of the items.
- 2) Although ROHM is confident that the example application circuit reflects the best possible recommendations, be sure to verify circuit characteristics for your particular application. Modification of constants for other externally connected circuits may cause variations in both static and transient characteristics for external components as well as this Rohm IC. Allow for sufficient margins when determining circuit constants.
- 3) Absolute maximum ratings
Use of the IC in excess of absolute maximum ratings, such as the applied voltage or operating temperature range (Topr), may result in IC damage. Assumptions should not be made regarding the state of the IC (short mode or open mode) when such damage is suffered. A physical safety measure, such as a fuse, should be implemented when using the IC at times where the absolute maximum ratings may be exceeded.
- 4) GND potential
Ensure a minimum GND pin potential in all operating conditions. Make sure that no pins are at a voltage below the GND at any time, regardless of whether it is a transient signal or not.
- 5) Thermal design
Perform thermal design, in which there are adequate margins, by taking into account the permissible dissipation (Pd) in actual states of use.
- 6) Short circuit between terminals and erroneous mounting
Pay attention to the assembly direction of the ICs. Wrong mounting direction or shorts between terminals, GND, or other components on the circuits, can damage the IC.
- 7) Operation in strong electromagnetic field
Using the ICs in a strong electromagnetic field can cause operation malfunction.

●Ordering part number

B	A
---	---

Part No.

5	4	0	6
---	---	---	---

Part No.
5406
5417

--	--

Package
None: SIP-M12
HSIP15

--	--

Packaging and forming specification
None: Tube

SIP-M12

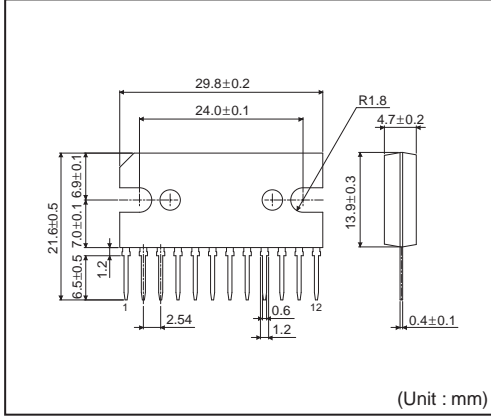

<Tape and Reel information>

Container	Tube
Quantity	300pcs
Direction of feed	Direction of products is fixed in a container tube

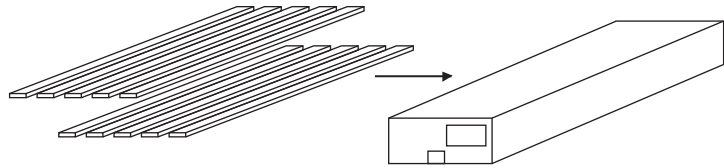

* Order quantity needs to be multiple of the minimum quantity.

HSIP15

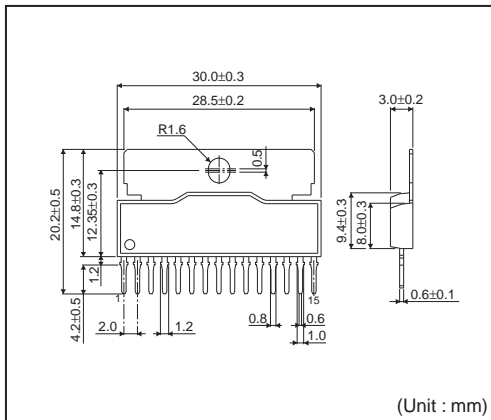

<Tape and Reel information>

Container	Tube
Quantity	300pcs
Direction of feed	Direction of products is fixed in a container tube

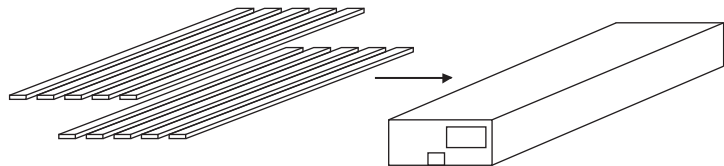

* Order quantity needs to be multiple of the minimum quantity.

Notice

Precaution on using ROHM Products

- Our Products are designed and manufactured for application in ordinary electronic equipments (such as AV equipment, OA equipment, telecommunication equipment, home electronic appliances, amusement equipment, etc.). If you intend to use our Products in devices requiring extremely high reliability (such as medical equipment ^(Note 1), transport equipment, traffic equipment, aircraft/spacecraft, nuclear power controllers, fuel controllers, car equipment including car accessories, safety devices, etc.) and whose malfunction or failure may cause loss of human life, bodily injury or serious damage to property ("Specific Applications"), please consult with the ROHM sales representative in advance. Unless otherwise agreed in writing by ROHM in advance, ROHM shall not be in any way responsible or liable for any damages, expenses or losses incurred by you or third parties arising from the use of any ROHM's Products for Specific Applications.

(Note1) Medical Equipment Classification of the Specific Applications

JAPAN	USA	EU	CHINA
CLASS III	CLASS III	CLASS II b	CLASS III
CLASS IV		CLASS III	

- ROHM designs and manufactures its Products subject to strict quality control system. However, semiconductor products can fail or malfunction at a certain rate. Please be sure to implement, at your own responsibilities, adequate safety measures including but not limited to fail-safe design against the physical injury, damage to any property, which a failure or malfunction of our Products may cause. The following are examples of safety measures:
 - Installation of protection circuits or other protective devices to improve system safety
 - Installation of redundant circuits to reduce the impact of single or multiple circuit failure
- Our Products are designed and manufactured for use under standard conditions and not under any special or extraordinary environments or conditions, as exemplified below. Accordingly, ROHM shall not be in any way responsible or liable for any damages, expenses or losses arising from the use of any ROHM's Products under any special or extraordinary environments or conditions. If you intend to use our Products under any special or extraordinary environments or conditions (as exemplified below), your independent verification and confirmation of product performance, reliability, etc. prior to use, must be necessary:
 - Use of our Products in any types of liquid, including water, oils, chemicals, and organic solvents
 - Use of our Products outdoors or in places where the Products are exposed to direct sunlight or dust
 - Use of our Products in places where the Products are exposed to sea wind or corrosive gases, including Cl₂, H₂S, NH₃, SO₂, and NO₂
 - Use of our Products in places where the Products are exposed to static electricity or electromagnetic waves
 - Use of our Products in proximity to heat-producing components, plastic cords, or other flammable items
 - Sealing or coating our Products with resin or other coating materials
 - Use of our Products without cleaning residue of flux (even if you use no-clean type fluxes, cleaning residue of flux is recommended); or Washing our Products by using water or water-soluble cleaning agents for cleaning residue after soldering
 - Use of the Products in places subject to dew condensation
- The Products are not subject to radiation-proof design.
- Please verify and confirm characteristics of the final or mounted products in using the Products.
- In particular, if a transient load (a large amount of load applied in a short period of time, such as pulse. is applied, confirmation of performance characteristics after on-board mounting is strongly recommended. Avoid applying power exceeding normal rated power; exceeding the power rating under steady-state loading condition may negatively affect product performance and reliability.
- De-rate Power Dissipation (Pd) depending on Ambient temperature (Ta). When used in sealed area, confirm the actual ambient temperature.
- Confirm that operation temperature is within the specified range described in the product specification.
- ROHM shall not be in any way responsible or liable for failure induced under deviant condition from what is defined in this document.

Precaution for Mounting / Circuit board design

- When a highly active halogenous (chlorine, bromine, etc.) flux is used, the residue of flux may negatively affect product performance and reliability.
- In principle, the reflow soldering method must be used; if flow soldering method is preferred, please consult with the ROHM representative in advance.

For details, please refer to ROHM Mounting specification

Precautions Regarding Application Examples and External Circuits

1. If change is made to the constant of an external circuit, please allow a sufficient margin considering variations of the characteristics of the Products and external components, including transient characteristics, as well as static characteristics.
2. You agree that application notes, reference designs, and associated data and information contained in this document are presented only as guidance for Products use. Therefore, in case you use such information, you are solely responsible for it and you must exercise your own independent verification and judgment in the use of such information contained in this document. ROHM shall not be in any way responsible or liable for any damages, expenses or losses incurred by you or third parties arising from the use of such information.

Precaution for Electrostatic

This Product is electrostatic sensitive product, which may be damaged due to electrostatic discharge. Please take proper caution in your manufacturing process and storage so that voltage exceeding the Products maximum rating will not be applied to Products. Please take special care under dry condition (e.g. Grounding of human body / equipment / solder iron, isolation from charged objects, setting of ionizer, friction prevention and temperature / humidity control).

Precaution for Storage / Transportation

1. Product performance and soldered connections may deteriorate if the Products are stored in the places where:
 - [a] the Products are exposed to sea winds or corrosive gases, including Cl₂, H₂S, NH₃, SO₂, and NO₂
 - [b] the temperature or humidity exceeds those recommended by ROHM
 - [c] the Products are exposed to direct sunshine or condensation
 - [d] the Products are exposed to high Electrostatic
2. Even under ROHM recommended storage condition, solderability of products out of recommended storage time period may be degraded. It is strongly recommended to confirm solderability before using Products of which storage time is exceeding the recommended storage time period.
3. Store / transport cartons in the correct direction, which is indicated on a carton with a symbol. Otherwise bent leads may occur due to excessive stress applied when dropping of a carton.
4. Use Products within the specified time after opening a humidity barrier bag. Baking is required before using Products of which storage time is exceeding the recommended storage time period.

Precaution for Product Label

QR code printed on ROHM Products label is for ROHM's internal use only.

Precaution for Disposition

When disposing Products please dispose them properly using an authorized industry waste company.

Precaution for Foreign Exchange and Foreign Trade act

Since our Products might fall under controlled goods prescribed by the applicable foreign exchange and foreign trade act, please consult with ROHM representative in case of export.

Precaution Regarding Intellectual Property Rights

1. All information and data including but not limited to application example contained in this document is for reference only. ROHM does not warrant that foregoing information or data will not infringe any intellectual property rights or any other rights of any third party regarding such information or data. ROHM shall not be in any way responsible or liable for infringement of any intellectual property rights or other damages arising from use of such information or data.:
2. No license, expressly or implied, is granted hereby under any intellectual property rights or other rights of ROHM or any third parties with respect to the information contained in this document.

Other Precaution



1. This document may not be reprinted or reproduced, in whole or in part, without prior written consent of ROHM.
2. The Products may not be disassembled, converted, modified, reproduced or otherwise changed without prior written consent of ROHM.
3. In no event shall you use in any way whatsoever the Products and the related technical information contained in the Products or this document for any military purposes, including but not limited to, the development of mass-destruction weapons.
4. The proper names of companies or products described in this document are trademarks or registered trademarks of ROHM, its affiliated companies or third parties.

General Precaution

1. Before you use our Products, you are requested to carefully read this document and fully understand its contents. ROHM shall not be in any way responsible or liable for failure, malfunction or accident arising from the use of any ROHM's Products against warning, caution or note contained in this document.
2. All information contained in this document is current as of the issuing date and subject to change without any prior notice. Before purchasing or using ROHM's Products, please confirm the latest information with a ROHM sales representative.
3. The information contained in this document is provided on an "as is" basis and ROHM does not warrant that all information contained in this document is accurate and/or error-free. ROHM shall not be in any way responsible or liable for any damages, expenses or losses incurred by you or third parties resulting from inaccuracy or errors of or concerning such information.

Looking for pricing, stock, or lifecycle information?

Click below to explore more details on WIN SOURCE:

-  [View BA5406](#) on WIN SOURCE
-  [Rohm Semiconductor](#) Information

Optimize Your Supply Chain with WIN SOURCE Solutions

-  Global Sourcing Solution
-  Obsolete Management
-  Cost Control Management
-  Shortage Management
-  Alternative Solution
-  Excess Inventory Management