



**THE DATASHEET OF  
LT6703HVIS5-2#TRMPBF**



# Micropower, Low Voltage Comparator with 400mV Reference

## FEATURES

- Internal 400mV Reference
- Total Threshold Error:  $\pm 1.25\%$  Max at 25°C
- Wide Supply Range: 1.4V to 18V
- Input and Output Operate to 36V
- Specified for -40°C to 125°C Temperature Range
- Low Quiescent Current: 6.5µA Typ at 5V
- Internal Hysteresis: 6.5mV Typ
- Low Input Bias Current:  $\pm 10$ nA Max
- Over-The-Top® Input also Includes Ground
- Open-Collector Output Allows Level Translation
- Choice of Input Polarities: LT6703-2/LT6703-3/LT6703HV-2/LT6703HV-3
- Available in 2mm × 2mm DFN and Low Profile (1mm) SOT-23 (ThinSOT™) Packages

## APPLICATIONS

- Battery-Powered System Monitoring
- Threshold Detectors
- Window Comparators
- Relay Driving
- Industrial Control Systems
- Handheld Instruments
- Automotive Monitor and Controls

## DESCRIPTION

The LT®6703-2/LT6703-3/LT6703HV-2/LT6703HV-3 combine a micropower, low voltage comparator with a 400mV reference in a tiny DFN package. Operating with supplies from 1.4V up to 18V, these devices draw only 6.5µA, making them ideal for low voltage system monitoring. Hysteresis is included in the comparator, ensuring stable operation.

The comparator has one input available externally while the other input is connected internally to the reference. The comparator output is open collector and the output load can be referred to any voltage up to 18V (36V for LT6703HV) independent of supply voltage. The output stage has a guaranteed current sink capability of more than 5mA over temperature.

The two versions of this part differ by the polarity of the available comparator input. The LT6703-2/LT6703HV-2 has an inverting input and the LT6703-3/LT6703HV-3 has a noninverting input. Both versions are offered in commercial, industrial and automotive temperature ranges.

LT, LT, LTC, LTM, Linear Technology, the Linear logo and Over-The-Top are registered trademarks of Linear Technology Corporation. ThinSOT is a trademark of Linear Technology Corporation. All other trademarks are the property of their respective owners.

## TYPICAL APPLICATION

Micropower Supply Voltage Monitor

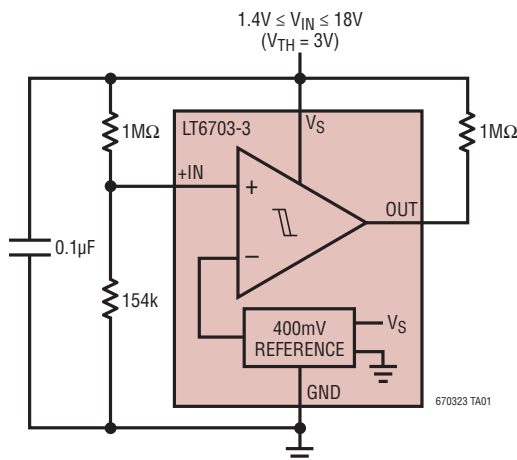

Rising Input Threshold Voltage vs Temperature

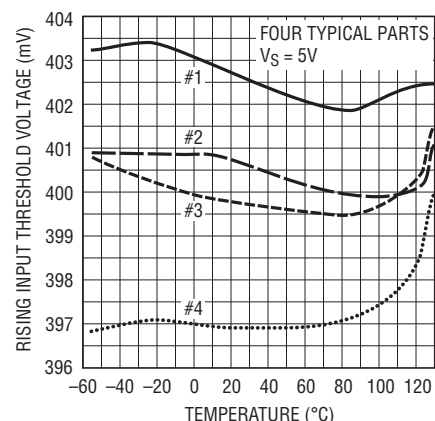

670323 TA01b

670323fd

# LT6703-2/LT6703-3 LT6703HV-2/LT6703HV-3

## ABSOLUTE MAXIMUM RATINGS

(Note 1)

Total Supply Voltage ( $V_S$  to GND) ..... 18.5V  
 Input Voltage (+IN, -IN)  
 (Note 3)..... 18.5V to (GND - 0.3V)  
 LT6703HV ..... 40V to (GND - 0.3V)  
 Output Voltage (OUT)..... 18.5V to (GND - 0.3V)  
 LT6703HV ..... 40V to (GND - 0.3V)  
 Output Short-Circuit Duration (Note 2) ..... Indefinite  
 Input Current (Note 3)..... -10mA

Operating Temperature Range (Note 4)  
 LT6703C-2/-3/LT6703HVC-2/-3 ..... -40°C to 85°C  
 LT6703I-2/-3/LT6703HVI-2/-3 ..... -40°C to 85°C  
 LT6703H-2/-3/LT6703HVH-2/-3 ..... -40°C to 125°C  
 Specified Temperature Range (Note 5)  
 LT6703C-2/-3/LT6703HVC-2/-3 ..... 0°C to 70°C  
 LT6703I-2/-3/LT6703HVI-2/-3 ..... -40°C to 85°C  
 LT6703H-2/-3/LT6703HVH-2/-3 ..... -40°C to 125°C  
 Maximum Junction Temperature..... 125°C  
 Storage Temperature Range..... -65°C to 125°C  
 Lead Temperature (Soldering, 10 sec) ..... 300°C

## PIN CONFIGURATION

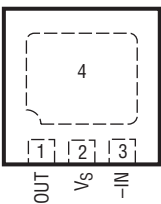
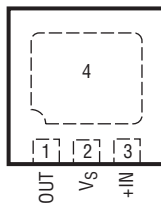
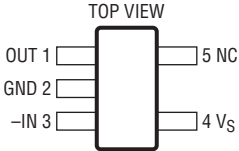
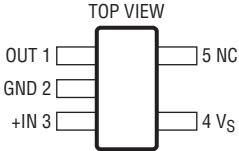
<p><b>LT6703-2</b></p> <p>TOP VIEW</p>  <p>DC PACKAGE          3-LEAD (2mm × 2mm) PLASTIC DFN  <math>T_{JMAX} = 125^{\circ}\text{C}</math>, <math>\theta_{JA} = 102^{\circ}\text{C/W}</math>          EXPOSED PAD (PIN 4) IS GND, MUST BE SOLDERED TO PCB</p>	<p><b>LT6703-3</b></p> <p>TOP VIEW</p>  <p>DC PACKAGE          3-LEAD (2mm × 2mm) PLASTIC DFN  <math>T_{JMAX} = 125^{\circ}\text{C}</math>, <math>\theta_{JA} = 102^{\circ}\text{C/W}</math>          EXPOSED PAD (PIN 4) IS GND, MUST BE SOLDERED TO PCB</p>
<p><b>LT6703HV-2</b></p> <p>TOP VIEW</p>  <p>S5 PACKAGE          5-LEAD PLASTIC TSOT-23  <math>T_{JMAX} = 125^{\circ}\text{C}</math>, <math>\theta_{JA} = 250^{\circ}\text{C/W}</math></p>	<p><b>LT6703HV-3</b></p> <p>TOP VIEW</p>  <p>S5 PACKAGE          5-LEAD PLASTIC TSOT-23  <math>T_{JMAX} = 125^{\circ}\text{C}</math>, <math>\theta_{JA} = 250^{\circ}\text{C/W}</math></p>

## ORDER INFORMATION

### Lead Free Finish

TAPE AND REEL (MINI)	TAPE AND REEL	PART MARKING*	PACKAGE DESCRIPTION	SPECIFIED TEMPERATURE RANGE
LT6703CDC-2#TRMPBF	LT6703CDC-2#TRPBF	LCWP	3-Lead (2mm × 2mm) Plastic DFN	0°C to 70°C
LT6703IDC-2#TRMPBF	LT6703IDC-2#TRPBF	LCWP	3-Lead (2mm × 2mm) Plastic DFN	-40°C to 85°C
LT6703HDC-2#TRMPBF	LT6703HDC-2#TRPBF	LCWP	3-Lead (2mm × 2mm) Plastic DFN	-40°C to 125°C
LT6703CDC-3#TRMPBF	LT6703CDC-3#TRPBF	LCTW	3-Lead (2mm × 2mm) Plastic DFN	0°C to 70°C
LT6703IDC-3#TRMPBF	LT6703IDC-3#TRPBF	LCTW	3-Lead (2mm × 2mm) Plastic DFN	-40°C to 85°C
LT6703HDC-3#TRMPBF	LT6703HDC-3#TRPBF	LCTW	3-Lead (2mm × 2mm) Plastic DFN	-40°C to 125°C
LT6703HVCS5-2#TRMPBF	LT6703HVCS5-2#TRPBF	LTDMM	5-Lead Plastic TSOT-23	0°C to 70°C
LT6703HVIS5-2#TRMPBF	LT6703HVIS5-2#TRPBF	LTDMM	5-Lead Plastic TSOT-23	-40°C to 85°C
LT6703HVHS5-2#TRMPBF	LT6703HVHS5-2#TRPBF	LTDMM	5-Lead Plastic TSOT-23	-40°C to 125°C
LT6703HVCS5-3#TRMPBF	LT6703HVCS5-3#TRPBF	LTDMP	5-Lead Plastic TSOT-23	0°C to 70°C
LT6703HVIS5-3#TRMPBF	LT6703HVIS5-3#TRPBF	LTDMP	5-Lead Plastic TSOT-23	-40°C to 85°C
LT6703HVHS5-3#TRMPBF	LT6703HVHS5-3#TRPBF	LTDMP	5-Lead Plastic TSOT-23	-40°C to 125°C

TRM = 500 pieces. \*Temperature grades are identified by a label on the shipping container.

Consult LTC Marketing for parts specified with wider operating temperature ranges.

Consult LTC Marketing for information on lead based finish parts.

For more information on lead free part marking, go to: <http://www.linear.com/leadfree/>

For more information on tape and reel specifications, go to: <http://www.linear.com/tapeandreel/>

## ELECTRICAL CHARACTERISTICS $T_A = 25^\circ\text{C}$ (LT6703-2/LT6703-3) unless otherwise specified.

SYMBOL	PARAMETER	CONDITIONS	MIN	TYP	MAX	UNITS
$V_{TH(R)}$	Rising Input Threshold Voltage (Note 6)	$R_L = 100k, V_O = 2V$ Swing, $V_S = 5V$	395	400	405	mV
$V_{TH(F)}$	Falling Input Threshold Voltage (Note 6)	$R_L = 100k, V_O = 2V$ Swing, $V_S = 5V$	387	393.5	400	mV
HYS	$HYS = V_{TH(R)} - V_{TH(F)}$	$V_S = 5V, R_L = 100k, V_O = 2V$ Swing	3.5	6.5	9.5	mV
$I_B$	Input Bias Current	$V_S = 1.4V, 18V, V_{IN} = V_S$ $V_S = 1.4V, V_{IN} = 18V$ $V_S = 1.4V, 18V, V_{IN} = 0.1V$		$\pm 0.01$ $\pm 0.01$ $\pm 4$	$\pm 10$ $\pm 10$ $\pm 10$	nA nA nA
$V_{OL}$	Output Low Voltage	10mV Input Overdrive, $V_S = 5V, I_{OUT} = 5mA$		70	200	mV
$I_{OFF}$	Output Leakage Current	$V_S = 1.4V, 18V, V_{OUT} = V_S, V_{IN} = 40mV$ Overdrive $V_S = 1.4V, V_{OUT} = 18V, V_{IN} = 40mV$ Overdrive		0.01 0.01	0.8 0.8	$\mu A$ $\mu A$
$t_{PD(HL)}$	High-to-Low Propagation Delay	$V_S = 5V, 10mV$ Input Overdrive, $R_L = 10k$ , $V_{OL} = 400mV$		18		$\mu s$
$t_{PD(LH)}$	Low-to-High Propagation Delay	$V_S = 5V, 10mV$ Input Overdrive, $R_L = 10k$ , $V_{OH} = 0.9 \cdot V_S$		29		$\mu s$
$t_r$	Output Rise Time	$V_S = 5V, 10mV$ Input Overdrive, $R_L = 10k$ $V_O = (0.1 \text{ to } 0.9) \cdot V_S$		2.2		$\mu s$
$t_f$	Output Fall Time	$V_S = 5V, 10mV$ Input Overdrive, $R_L = 10k$ $V_O = (0.1 \text{ to } 0.9) \cdot V_S$		0.22		$\mu s$
$I_S$	Supply Current	No Load Current, $V_S = 5V$		6.5	11	$\mu A$

# LT6703-2/LT6703-3

## LT6703HV-2/LT6703HV-3

**ELECTRICAL CHARACTERISTICS** The ● denotes the specifications which apply over the temperature range of  $0^{\circ}\text{C} \leq T_A \leq 70^{\circ}\text{C}$ , (LT6703C-2/LT6703C-3) unless otherwise specified (Notes 4, 5).

SYMBOL	PARAMETER	CONDITIONS	MIN	TYP	MAX	UNITS
$V_{TH(R)}$	Rising Input Threshold Voltage (Note 6)	$R_L = 100k, V_O = 2V \text{ Swing}, V_S = 5V$	● 392.5		407.5	mV
$V_{TH(F)}$	Falling Input Threshold Voltage (Note 6)	$R_L = 100k, V_O = 2V \text{ Swing}, V_S = 5V$	● 384.5		402.5	mV
HYS	$HYS = V_{TH(R)} - V_{TH(F)}$	$V_S = 5V, R_L = 100k, V_O = 2V \text{ Swing}$	● 3		11	mV
$I_B$	Input Bias Current	$V_S = 1.4V, 18V, V_{IN} = V_S$ $V_S = 1.4V, V_{IN} = 18V$ $V_S = 1.4V, 18V, V_{IN} = 0.1V$	●		±15 ±15 ±15	nA nA nA
$V_{OL}$	Output Low Voltage	10mV Input Overdrive, $V_S = 5V, I_{OUT} = 5mA$	●		250	mV
$I_{OFF}$	Output Leakage Current	$V_S = 1.4V, 18V, V_{OUT} = V_S, V_{IN} = 40mV \text{ Overdrive}$ $V_S = 1.4V, V_{OUT} = 18V, V_{IN} = 40mV \text{ Overdrive}$	●		1 1	$\mu A$ $\mu A$
$I_S$	Supply Current	No Load Current, $V_S = 5V$	●		14	$\mu A$

The ● denotes the specifications which apply over the temperature range of  $-40^{\circ}\text{C} \leq T_A \leq 85^{\circ}\text{C}$ , (LT6703I-2/LT6703I-3) unless otherwise specified (Notes 4, 5).

SYMBOL	PARAMETER	CONDITIONS	MIN	TYP	MAX	UNITS
$V_{TH(R)}$	Rising Input Threshold Voltage (Note 6)	$R_L = 100k, V_O = 2V \text{ Swing}, V_S = 5V$	● 392		408	mV
$V_{TH(F)}$	Falling Input Threshold Voltage (Note 6)	$R_L = 100k, V_O = 2V \text{ Swing}, V_S = 5V$	● 383.5		403.5	mV
HYS	$HYS = V_{TH(R)} - V_{TH(F)}$	$V_S = 5V, R_L = 100k, V_O = 2V \text{ Swing}$	● 2		11.5	mV
$I_B$	Input Bias Current	$V_S = 1.4V, 18V, V_{IN} = V_S$ $V_S = 1.4V, V_{IN} = 18V$ $V_S = 1.4V, 18V, V_{IN} = 0.1V$	●		±15 ±15 ±15	nA nA nA
$V_{OL}$	Output Low Voltage	10mV Input Overdrive, $V_S = 5V, I_{OUT} = 5mA$	●		250	mV
$I_{OFF}$	Output Leakage Current	$V_S = 1.4V, 18V, V_{OUT} = V_S, V_{IN} = 40mV \text{ Overdrive}$ $V_S = 1.4V, V_{OUT} = 18V, V_{IN} = 40mV \text{ Overdrive}$	●		1 1	$\mu A$ $\mu A$
$I_S$	Supply Current	No Load Current, $V_S = 5V$	●		15	$\mu A$

The ● denotes the specifications which apply over the temperature range of  $-40^{\circ}\text{C} \leq T_A \leq 125^{\circ}\text{C}$ , (LT6703H-2/LT6703H-3) unless otherwise specified (Notes 4, 5).

SYMBOL	PARAMETER	CONDITIONS	MIN	TYP	MAX	UNITS
$V_{TH(R)}$	Rising Input Threshold Voltage (Note 6)	$R_L = 100k, V_O = 2V \text{ Swing}, V_S = 5V$	● 392		410	mV
$V_{TH(F)}$	Falling Input Threshold Voltage (Note 6)	$R_L = 100k, V_O = 2V \text{ Swing}, V_S = 5V$	● 382.5		404.5	mV
HYS	$HYS = V_{TH(R)} - V_{TH(F)}$	$V_S = 5V, R_L = 100k, V_O = 2V \text{ Swing}$	● 2		13.5	mV
$I_B$	Input Bias Current	$V_S = 1.4V, 18V, V_{IN} = V_S$ $V_S = 1.4V, V_{IN} = 18V$ $V_S = 1.4V, 18V, V_{IN} = 0.1V$	●		±45 ±45 ±50	nA nA nA
$V_{OL}$	Output Low Voltage	10mV Input Overdrive, $V_S = 5V, I_{OUT} = 5mA$	●		250	mV
$I_{OFF}$	Output Leakage Current	$V_S = 1.4V, 18V, V_{OUT} = V_S, V_{IN} = 40mV \text{ Overdrive}$ $V_S = 1.4V, V_{OUT} = 18V, V_{IN} = 40mV \text{ Overdrive}$	●		1 1	$\mu A$ $\mu A$
$I_S$	Supply Current	No Load Current, $V_S = 5V$	●		17	$\mu A$

**ELECTRICAL CHARACTERISTICS**  $T_A = 25^\circ\text{C}$ , (LT6703HV-2/LT6703HV-3) unless otherwise specified.

SYMBOL	PARAMETER	CONDITIONS	MIN	TYP	MAX	UNITS
$V_{TH(R)}$	Rising Input Threshold Voltage (Note 6)	$R_L = 100k$ , $V_O = 2V$ Swing, $V_S = 5V$	395	400	405	mV
$V_{TH(F)}$	Falling Input Threshold Voltage (Note 6)	$R_L = 100k$ , $V_O = 2V$ Swing, $V_S = 5V$	387	393.5	400	mV
HYS	$HYS = V_{TH(R)} - V_{TH(F)}$	$V_S = 5V$ , $R_L = 100k$ , $V_O = 2V$ Swing	3.5	6.5	9.5	mV
$I_B$	Input Bias Current	$V_S = 1.4V, 18V$ , $V_{IN} = V_S$ $V_S = 1.4V$ , $V_{IN} = 18V, 36V$ $V_S = 1.4V, 18V$ , $V_{IN} = 0.1V$		$\pm 0.01$ $\pm 0.01$ $\pm 4$	$\pm 10$ $\pm 10$ $\pm 10$	nA nA nA
$V_{OL}$	Output Low Voltage	10mV Input Overdrive, $V_S = 5V$ , $I_{OUT} = 5mA$		70	200	mV
$I_{OFF}$	Output Leakage Current	$V_S = 1.4V, 18V$ , $V_{OUT} = V_S$ , $V_{IN} = 40mV$ Overdrive $V_S = 18V$ , $V_{OUT} = 18V$ , (36V, $R_L = 100k$ ), $V_{IN} = 40mV$ Overdrive		0.01 0.01	0.8 0.8	$\mu A$ $\mu A$
$t_{PD(HL)}$	High-to-Low Propagation Delay	$V_S = 5V$ , 10mV Input Overdrive, $R_L = 10k$ , $V_{OL} = 400mV$		18		$\mu s$
$t_{PD(LH)}$	Low-to-High Propagation Delay	$V_S = 5V$ , 10mV Input Overdrive, $R_L = 10k$ , $V_{OH} = 0.9 \cdot V_S$		29		$\mu s$
$t_r$	Output Rise Time	$V_S = 5V$ , 10mV Input Overdrive, $R_L = 10k$ $V_O = (0.1 \text{ to } 0.9) \cdot V_S$		2.2		$\mu s$
$t_f$	Output Fall Time	$V_S = 5V$ , 10mV Input Overdrive, $R_L = 10k$ $V_O = (0.1 \text{ to } 0.9) \cdot V_S$		0.22		$\mu s$
$I_S$	Supply Current	No Load Current, $V_S = 5V$		6.5	11	$\mu A$

The ● denotes the specifications which apply over the temperature range of  $0^\circ\text{C} \leq T_A \leq 70^\circ\text{C}$ , (LT6703HVC-2/LT6703HVC-3) unless otherwise specified (Notes 4, 5).

SYMBOL	PARAMETER	CONDITIONS	MIN	TYP	MAX	UNITS
$V_{TH(R)}$	Rising Input Threshold Voltage (Note 6)	$R_L = 100k$ , $V_O = 2V$ Swing, $V_S = 5V$	●	392.5	407.5	mV
$V_{TH(F)}$	Falling Input Threshold Voltage (Note 6)	$R_L = 100k$ , $V_O = 2V$ Swing, $V_S = 5V$	●	384.5	402.5	mV
HYS	$HYS = V_{TH(R)} - V_{TH(F)}$	$V_S = 5V$ , $R_L = 100k$ , $V_O = 2V$ Swing	●	3	11	mV
$I_B$	Input Bias Current	$V_S = 1.4V, 18V$ , $V_{IN} = V_S$ $V_S = 1.4V$ , $V_{IN} = 18V, 36V$ $V_S = 1.4V, 18V$ , $V_{IN} = 0.1V$	● ● ●		$\pm 15$ $\pm 15$ $\pm 15$	nA nA nA
$V_{OL}$	Output Low Voltage	10mV Input Overdrive, $V_S = 5V$ , $I_{OUT} = 5mA$	●		250	mV
$I_{OFF}$	Output Leakage Current	$V_S = 1.4V, 18V$ , $V_{OUT} = V_S$ , $V_{IN} = 40mV$ Overdrive $V_S = 18V$ , $V_{OUT} = 18V$ , (36V, $R_L = 100k$ ), $V_{IN} = 40mV$ Overdrive	● ●		1 1	$\mu A$ $\mu A$
$I_S$	Supply Current	No Load Current, $V_S = 5V$	●		14	$\mu A$

The ● denotes the specifications which apply over the temperature range of  $-40^\circ\text{C} \leq T_A \leq 85^\circ\text{C}$ , (LT6703HVI-2/LT6703HVI-3) unless otherwise specified (Notes 4, 5).

SYMBOL	PARAMETER	CONDITIONS	MIN	TYP	MAX	UNITS
$V_{TH(R)}$	Rising Input Threshold Voltage (Note 6)	$R_L = 100k$ , $V_O = 2V$ Swing, $V_S = 5V$	●	392	408	mV
$V_{TH(F)}$	Falling Input Threshold Voltage (Note 6)	$R_L = 100k$ , $V_O = 2V$ Swing, $V_S = 5V$	●	383.5	403.5	mV
HYS	$HYS = V_{TH(R)} - V_{TH(F)}$	$V_S = 5V$ , $R_L = 100k$ , $V_O = 2V$ Swing	●	2	11.5	mV
$I_B$	Input Bias Current	$V_S = 1.4V, 18V$ , $V_{IN} = V_S$ $V_S = 1.4V$ , $V_{IN} = 18V, 36V$ $V_S = 1.4V, 18V$ , $V_{IN} = 0.1V$	● ● ●		$\pm 15$ $\pm 15$ $\pm 15$	nA nA nA

# LT6703-2/LT6703-3

## LT6703HV-2/LT6703HV-3

### ELECTRICAL CHARACTERISTICS

The ● denotes the specifications which apply over the temperature range of  $-40^{\circ}\text{C} \leq T_A \leq 85^{\circ}\text{C}$ , (LT6703HVI-2/LT6703HVI-3) unless otherwise specified (Notes 4, 5).

SYMBOL	PARAMETER	CONDITIONS	MIN	TYP	MAX	UNITS
$V_{OL}$	Output Low Voltage	10mV Input Overdrive, $V_S = 5\text{V}$ , $I_{OUT} = 5\text{mA}$	●		250	mV
$I_{OFF}$	Output Leakage Current	$V_S = 1.4\text{V}, 18\text{V}$ , $V_{OUT} = V_S$ , $V_{IN} = 40\text{mV}$ Overdrive $V_S = 18\text{V}$ , $V_{OUT} = 18\text{V}$ , (36V, $R_L = 100\text{k}$ ), $V_{IN} = 40\text{mV}$ Overdrive	●		1	$\mu\text{A}$
$I_S$	Supply Current	No Load Current, $V_S = 5\text{V}$	●		15	$\mu\text{A}$

The ● denotes the specifications which apply over the temperature range of  $-40^{\circ}\text{C} \leq T_A \leq 125^{\circ}\text{C}$ , (LT6703HVH-2/LT6703HVH-3) unless otherwise specified (Notes 4, 5).

SYMBOL	PARAMETER	CONDITIONS	MIN	TYP	MAX	UNITS
$V_{TH(R)}$	Rising Input Threshold Voltage (Note 6)	$R_L = 100\text{k}$ , $V_O = 2\text{V}$ Swing, $V_S = 5\text{V}$	●	392	410	mV
$V_{TH(F)}$	Falling Input Threshold Voltage (Note 6)	$R_L = 100\text{k}$ , $V_O = 2\text{V}$ Swing, $V_S = 5\text{V}$	●	382.5	404.5	mV
HYS	$HYS = V_{TH(R)} - V_{TH(F)}$	$V_S = 5\text{V}$ , $R_L = 100\text{k}$ , $V_O = 2\text{V}$ Swing	●	2	13.5	mV
$I_B$	Input Bias Current	$V_S = 1.4\text{V}, 18\text{V}$ , $V_{IN} = V_S$ $V_S = 1.4\text{V}$ , $V_{IN} = 18\text{V}, 36\text{V}$ $V_S = 1.4\text{V}, 18\text{V}$ , $V_{IN} = 0.1\text{V}$	●		$\pm 45$	nA
$V_{OL}$	Output Low Voltage	10mV Input Overdrive, $V_S = 5\text{V}$ , $I_{OUT} = 5\text{mA}$	●		250	mV
$I_{OFF}$	Output Leakage Current	$V_S = 1.4\text{V}, 18\text{V}$ , $V_{OUT} = V_S$ , $V_{IN} = 40\text{mV}$ Overdrive $V_S = 18\text{V}$ , $V_{OUT} = 18\text{V}$ , (36V, $R_L = 100\text{k}$ ), $V_{IN} = 40\text{mV}$ Overdrive	●		1	$\mu\text{A}$
$I_S$	Supply Current	No Load Current, $V_S = 5\text{V}$	●		17.0	$\mu\text{A}$

**Note 1:** Stresses beyond those listed under Absolute Maximum Ratings may cause permanent damage to the device. Exposure to any Absolute Maximum Rating condition for extended periods may affect device reliability and lifetime.

**Note 2:** A heat sink may be required to keep the junction temperature below the absolute maximum rating when the output is shorted indefinitely.

**Note 3:** The inputs are protected by ESD diodes to the ground pin. If the input voltage exceeds  $-0.3\text{V}$  below ground, the input current should be limited to less than 10mA.

**Note 4:** The LT6703C-2/-3/LT6703HVC-2/-3, and LT6703I-2/-3/LT6703HVI-2/-3 are guaranteed functional over the operating temperature range of  $-40^{\circ}\text{C}$  to  $85^{\circ}\text{C}$ .

The LT6703H-2/-3/LT6703HVH-2/-3, is guaranteed functional over the operating temperature range of  $-40^{\circ}\text{C}$  to  $125^{\circ}\text{C}$ .

**Note 5:** The LT6703C-2/-3/LT6703HVC-2/-3, are guaranteed to meet the specified performance from  $0^{\circ}\text{C}$  to  $70^{\circ}\text{C}$ . The LT6703C-2/-3/LT6703HVC-2/-3 are designed, characterized and expected to meet specified performance from  $-40^{\circ}\text{C}$  to  $85^{\circ}\text{C}$  but are not tested or QA sampled at these temperatures. The LT6703I-2/-3/LT6703HVI-2/-3, are guaranteed to meet specified performance from  $-40^{\circ}\text{C}$  to  $85^{\circ}\text{C}$ . The LT6703H-2/-3/LT6703HVH-2/-3, is guaranteed to meet specified performance from  $-40^{\circ}\text{C}$  to  $125^{\circ}\text{C}$ .

**Note 6:**  $V_{TH}$  defines the threshold voltage of the comparator and combines the effect of offset and reference accuracy.

## PIN FUNCTIONS

**OUT:** Open-Collector Output of Comparator. This pin provides drive for up to 40mA of load current. Off-state voltage may be as high as 18V (36V for LT6703HV) above GND, regardless of  $V_S$  used.

**GND:** Ground. This pin is also the low side return of the internal 400mV reference.

**IN:** External Input for Comparator. The voltage on this pin can range from  $-0.3\text{V}$  to 18V (36V for LT6703HV) with respect to GND regardless of  $V_S$  used. The input is noninverting for the LT6703-3/LT6703HV-3, and inverting for the LT6703-2/LT6703HV-2. The other comparator input is internally connected to the 400mV reference.

**$V_S$ :** Supply Voltage. The parts are characterized for operation with  $1.4\text{V} \leq V_S \leq 18\text{V}$  with respect to GND.

## PIN FUNCTIONS

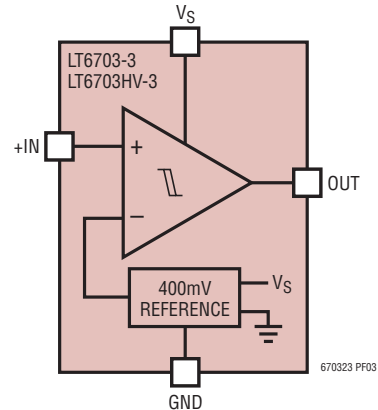
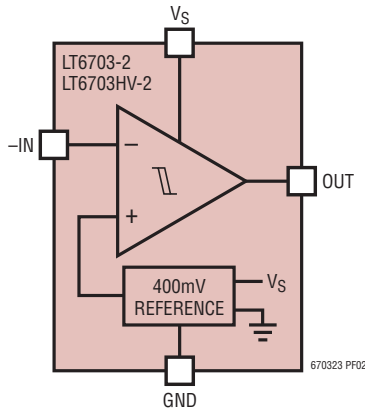

## TYPICAL PERFORMANCE CHARACTERISTICS

Distribution of Rising Input Threshold Voltage

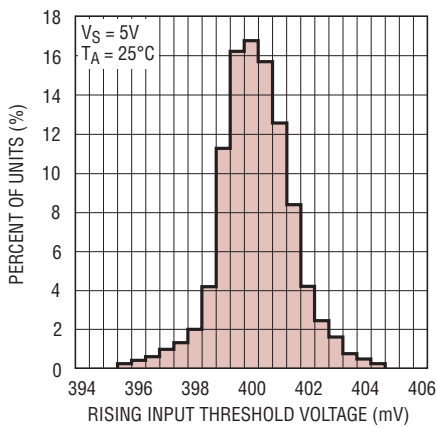

670323 G01

Distribution of Falling Input Threshold Voltage

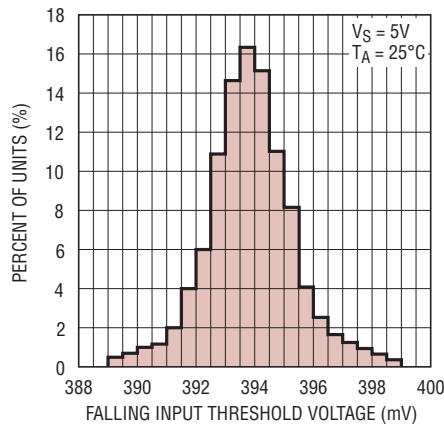

670323 G02

Distribution of Hysteresis

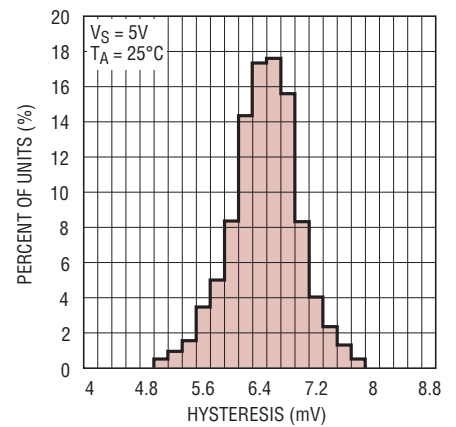

670323 G03

Rising Input Threshold Voltage vs Temperature

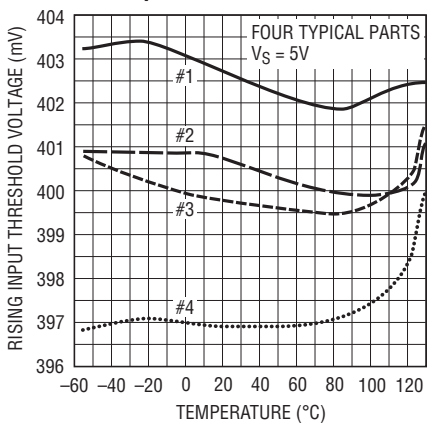

670323 G04

Rising Input Threshold Voltage vs Temperature

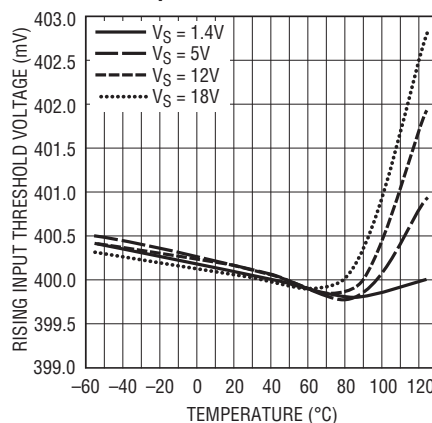

670323 G05

Rising Input Threshold Voltage vs Supply Voltage

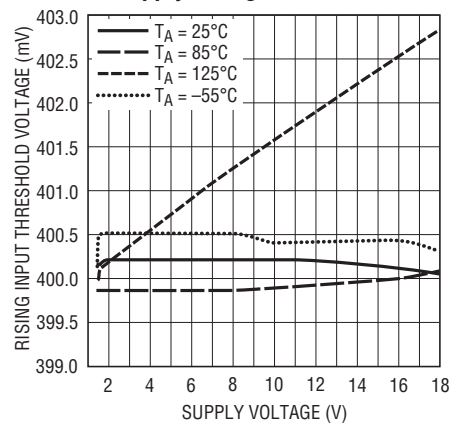

670323 G06

# TYPICAL PERFORMANCE CHARACTERISTICS

**Hysteresis vs Temperature**

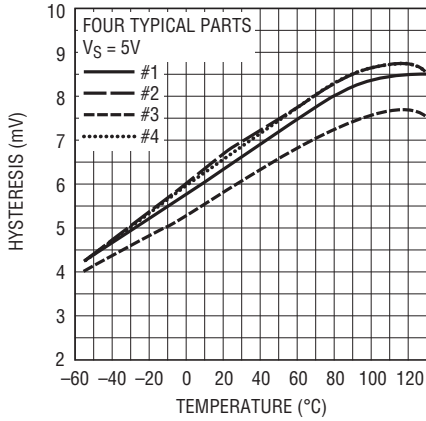

670323 G07

**Hysteresis vs Temperature**

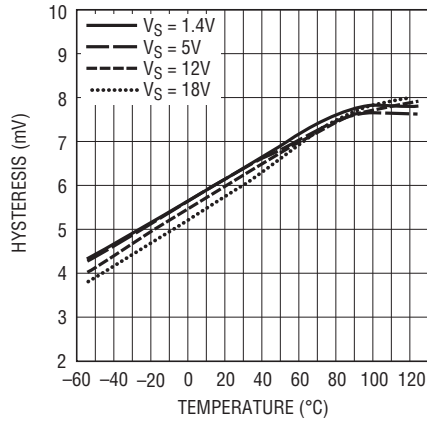

670323 G08

**Hysteresis vs Supply Voltage**

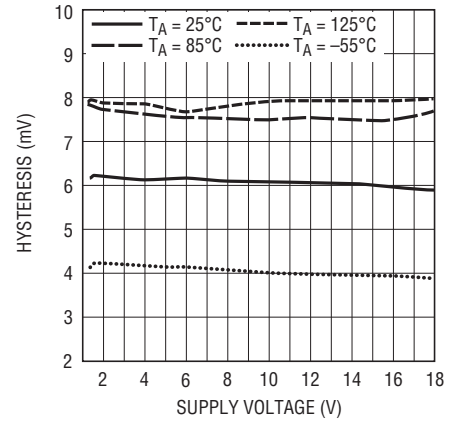

670323 G09

**Minimum Supply Voltage**

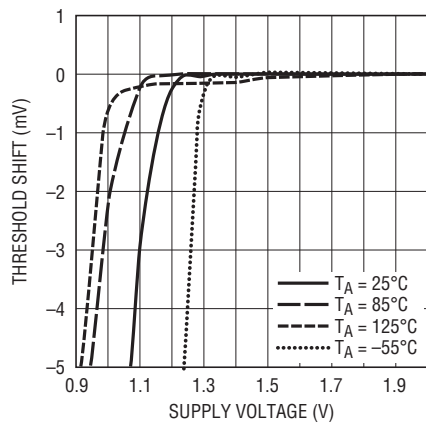

670323 G10

**Quiescent Supply Current vs Supply Voltage**

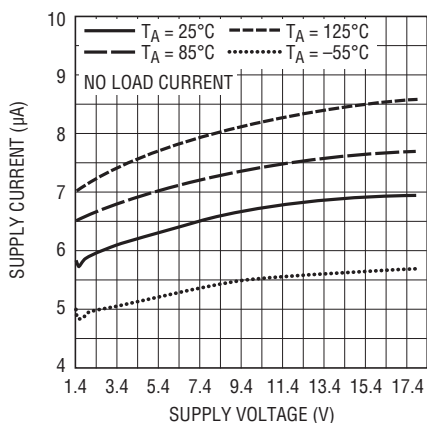

670323 G11

**Start-Up Supply Current**

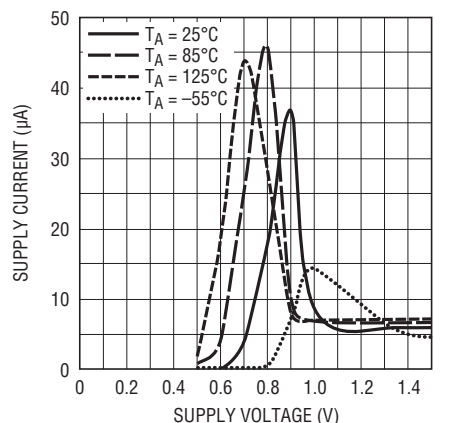

670323 G12

**Supply Current vs Output Sink Current**

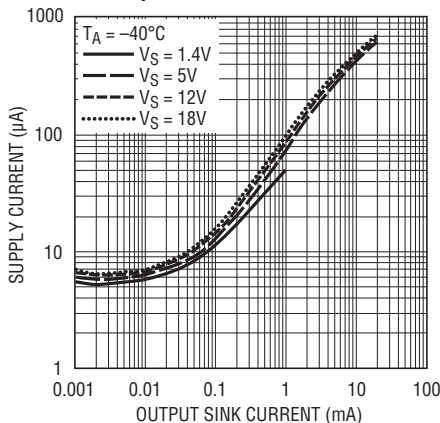

670323 G13

**Supply Current vs Output Sink Current**

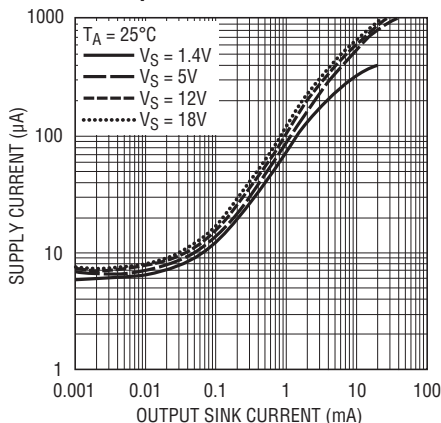

670323 G14

**Supply Current vs Output Sink Current**

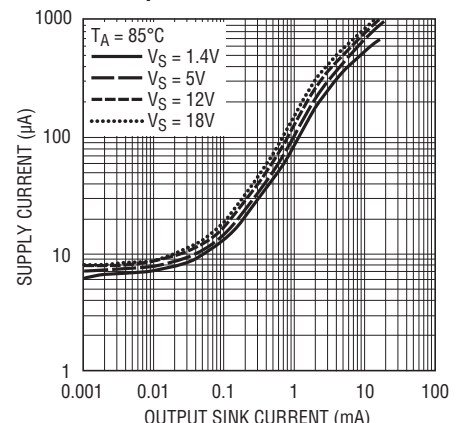

670323 G15

# TYPICAL PERFORMANCE CHARACTERISTICS

**Below Ground Input Bias Current**

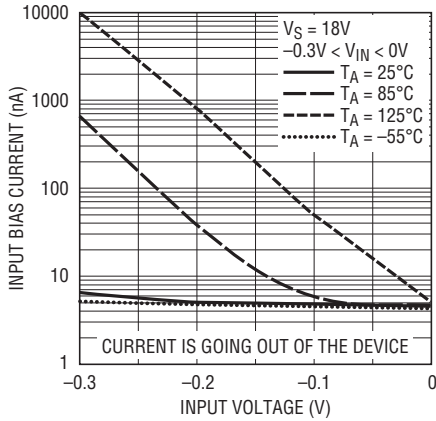

670323 G16

**Low Level Input Bias Current**

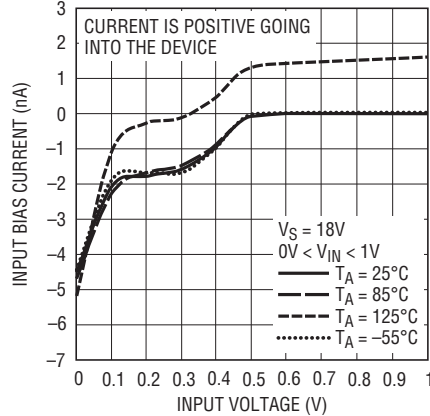

670323 G17

**High Level Input Bias Current**

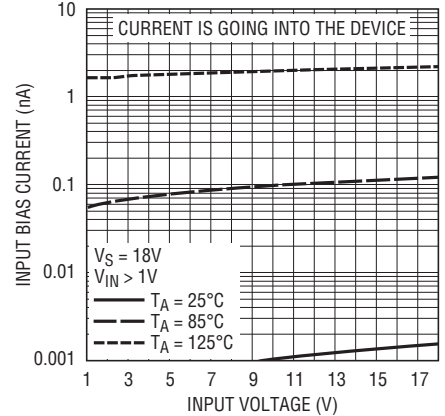

670323 G18

**Output Saturation Voltage vs Output Sink Current**

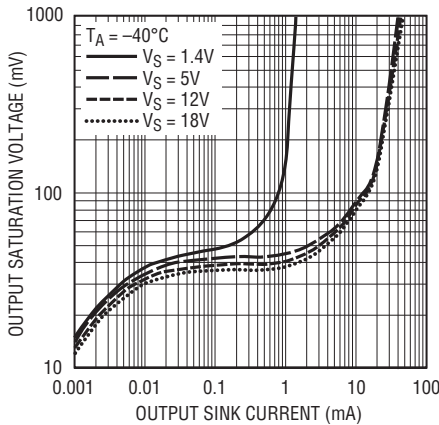

670323 G19

**Output Saturation Voltage vs Output Sink Current**

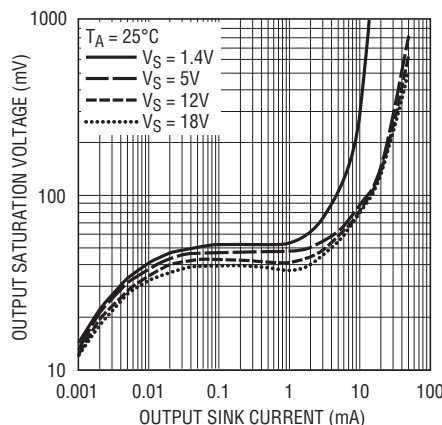

670323 G20

**Output Saturation Voltage vs Output Sink Current**

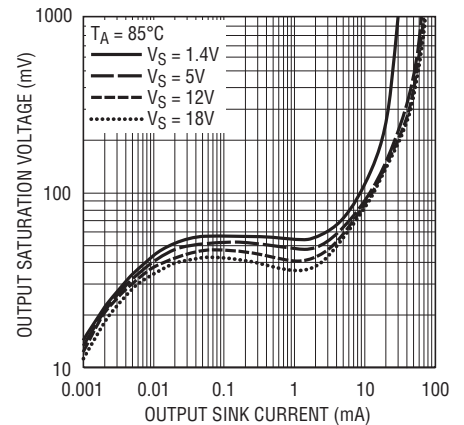

670323 G21

**Output Short-Circuit Current**

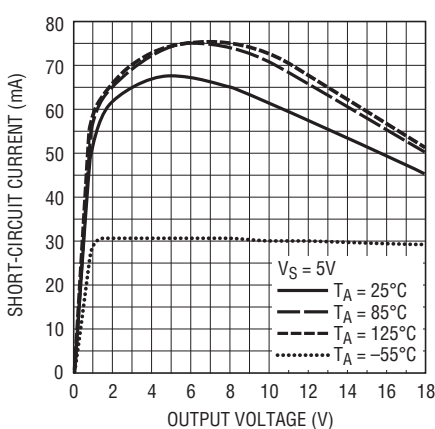

670323 G22

**Output Short-Circuit Current**

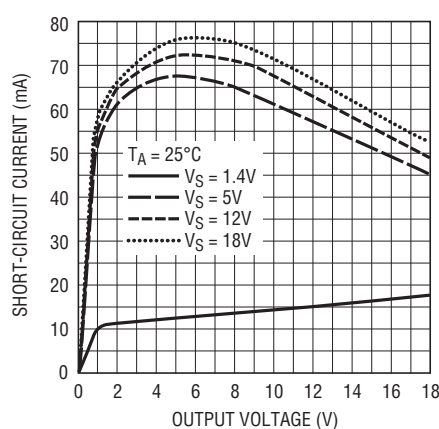

670323 G23

**Output Leakage Current**

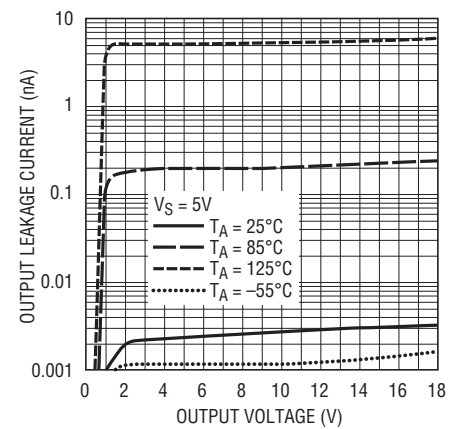

670323 G24

## TYPICAL PERFORMANCE CHARACTERISTICS

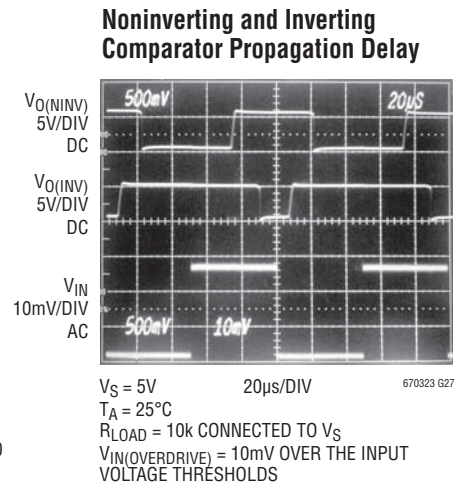
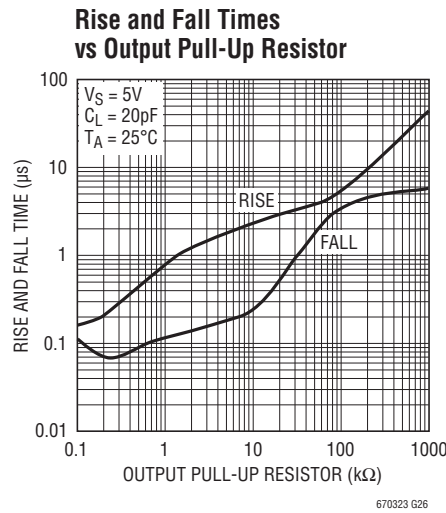
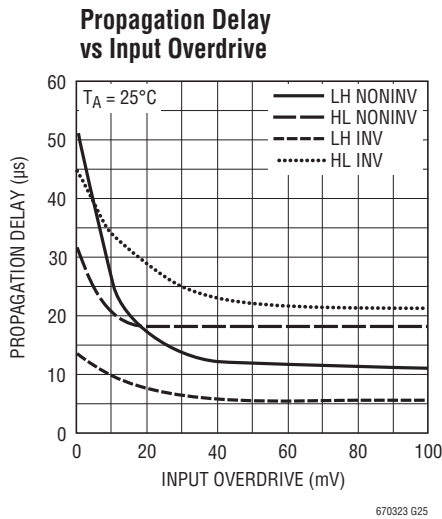

## APPLICATIONS INFORMATION

The LT6703-2/LT6703-3/LT6703HV-2/LT6703HV-3 devices are micropower comparators with a built-in 400mV reference. Features include wide supply voltage range (1.4V to 18V), Over-The-Top input and output range, 2% accurate rising input threshold voltage and 6.5mV typical built-in hysteresis.

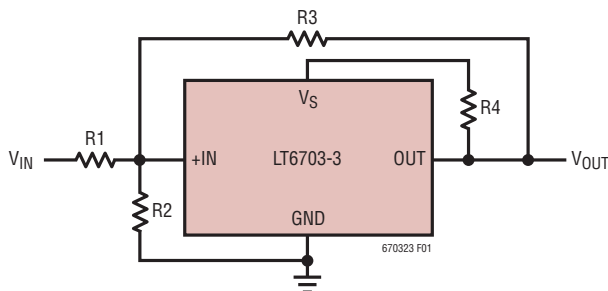

THRESHOLD EQUATIONS:

$$V_{IN} (\text{L TO H}) = (400\text{mV}) \cdot (R_1) \cdot \left( \frac{1}{R_1} + \frac{1}{R_2} + \frac{1}{R_3} \right)$$

$$V_{IN} (\text{H TO L}) = (393\text{mV}) \cdot (R_1) \cdot \left( \frac{1}{R_1} + \frac{1}{R_2} + \frac{1}{R_3 + R_4} \right) - \left( \frac{V_S \cdot R_1}{R_3 + R_4} \right)$$

Figure 1. Additional Hysteresis Circuit

### Internal Reference

Each comparator has one input available externally. The two versions of the part differ by the polarity of the available input (i.e., inverting or noninverting). The other comparator input is connected internally to the 400mV reference. The rising input threshold voltage of the comparator is designed to be equal to that of the reference (i.e.,  $\approx 400\text{mV}$ ). The reference voltage is established with respect to the device GND connection.

### Hysteresis

Each comparator has built-in 6.5mV (typical) of hysteresis to simplify designs, to insure stable operation in the presence of noise at the inputs, and to reject supply rail noise that might be induced by state change load transients. The hysteresis is designed such that the falling input threshold voltage is nominally 393.5mV. External positive feedback circuitry can be employed to increase effective hysteresis if desired, but such circuitry will provide an apparent effect on both the rising and falling input thresholds (the actual internal thresholds remain unaffected).

## APPLICATIONS INFORMATION

### Comparator Input

The comparator input can range from ground to 18V (36V for LT6703HV), regardless of the supply voltage used. The typical input current for inputs well above the threshold (i.e., >800mV) is a few pA leaking into the input. With decreasing input voltage, a small bias current begins to be drawn out of the input, reaching a few nA when at ground potential. The input may be forced 100mV below ground without causing an improper output, though some additional bias current will begin to flow from the ESD input protection diode. Inputs driven further negative than 100mV below ground will not cause damage provided the current is limited to 10mA.

### Comparator Output

The comparator output is open collector and capable of sinking 40mA typical. Load currents are directed out of the GND pin of the part. The output off-state voltage may range between -0.3V and 18V (36V for LT6703HV) with respect to ground, regardless of the supply voltage used. When the output high state bias voltage is above 18V, a 100k minimum pull-up resistor is required and no total load capacitor greater than 100nF should be used. If the output high state is above 18V, caution has to be taken to prevent a short from the output directly to the bias voltage, even if the output is in the off state. As with any open-collector device, the outputs of multiple comparators may be tied together to implement wire-AND logic functions.

### Power Supplies

The comparator circuitry operates from a single 1.4V to 18V supply. A minimum 0.1 $\mu$ F bypass capacitor is required between the  $V_S$  pin and GND. When an output load is connected to the supply rail near the part and the output is sinking more than 5mA, a 1 $\mu$ F bypass capacitor is recommended. In instances where the supply is relatively "soft" (such as with small batteries) and susceptible to load steps, an additional 47 $\Omega$  series decoupling resistor can further improve isolation of supply transients from the  $V_S$  pin.

## PACKAGE DESCRIPTION

**DC Package**  
**3-Lead Plastic DFN (2mm × 2mm)**  
 (Reference LTC DWG # 05-08-1717 Rev A)

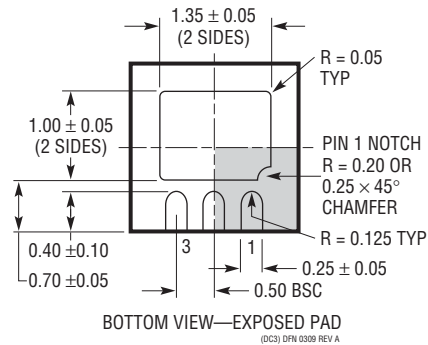
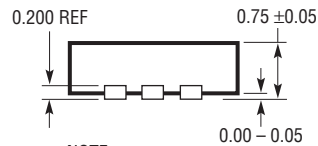
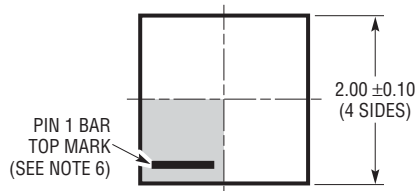
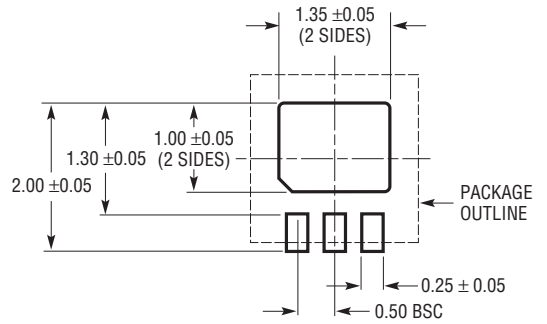

**NOTE:**

1. DRAWING TO BE MADE A JEDEC PACKAGE OUTLINE M0-229 VARIATION OF (W-TBD)
2. DRAWING NOT TO SCALE
3. ALL DIMENSIONS ARE IN MILLIMETERS
4. DIMENSIONS OF EXPOSED PAD ON BOTTOM OF PACKAGE DO NOT INCLUDE MOLD FLASH. MOLD FLASH, IF PRESENT, SHALL NOT EXCEED 0.15mm ON ANY SIDE
5. EXPOSED PAD SHALL BE SOLDER PLATED
6. SHADED AREA IS ONLY A REFERENCE FOR PIN 1 LOCATION ON THE TOP AND BOTTOM OF PACKAGE

## PACKAGE DESCRIPTION

**S5 Package**  
**5-Lead Plastic TSOT-23**  
 (Reference LTC DWG # 05-08-1635 Rev B)

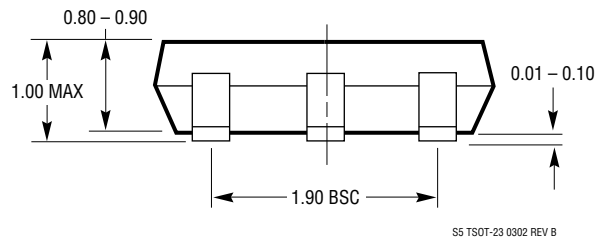
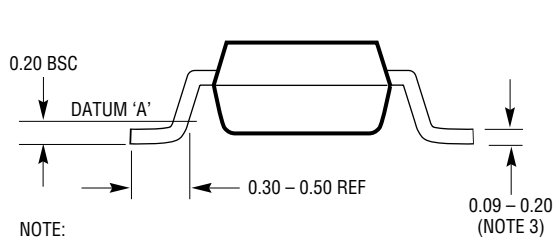
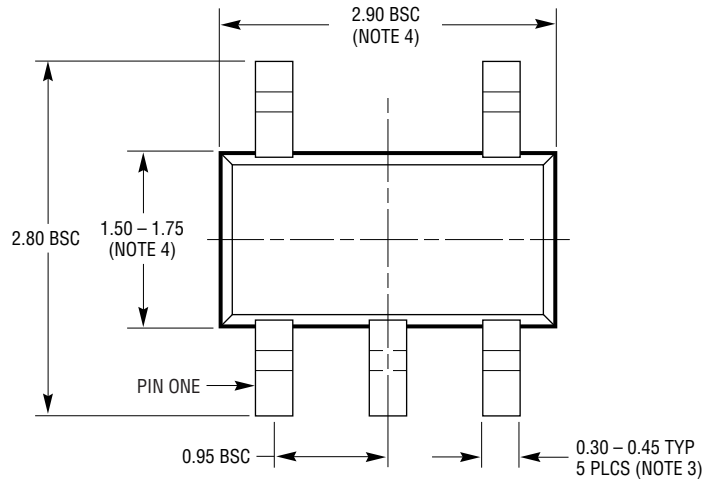
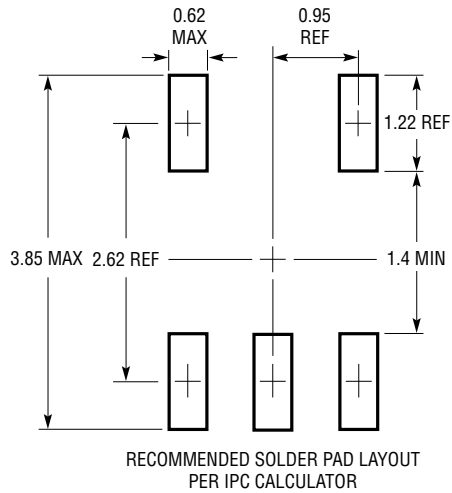

- NOTE:
1. DIMENSIONS ARE IN MILLIMETERS
  2. DRAWING NOT TO SCALE
  3. DIMENSIONS ARE INCLUSIVE OF PLATING
  4. DIMENSIONS ARE EXCLUSIVE OF MOLD FLASH AND METAL BURR
  5. MOLD FLASH SHALL NOT EXCEED 0.254mm
  6. JEDEC PACKAGE REFERENCE IS MO-193

S5 TSOT-23 0302 REV B

## TYPICAL APPLICATIONS

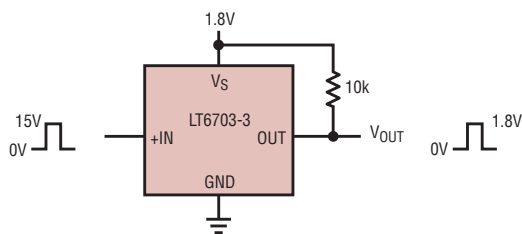

**Level Translator  
 High Voltage to Low Voltage**

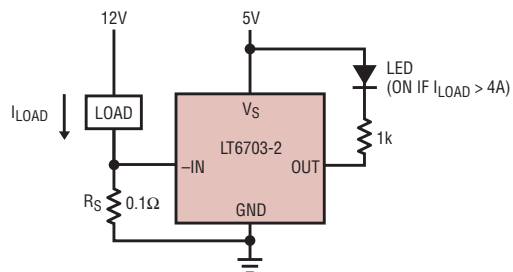

**Low Side Current Sense Alarm**

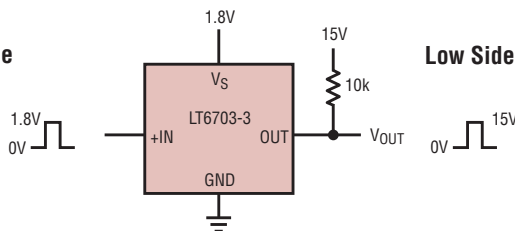

**Level Translator  
 Low Voltage to High Voltage**

670323 TA02

## RELATED PARTS

PART NUMBER	DESCRIPTION	COMMENTS
LT1017/LT1018	Micropower Dual Comparator	1.1V (Min) Supply Voltage, $\pm 1.4\text{mV}$ (Max) Input Offset
LTC1441/LTC1442	Micropower Dual Comparator with 1% Reference	1.182 $\pm 1\%$ Reference, $\pm 10\text{mV}$ (Max) Input Offset
LTC1998	Micropower Comparator for Battery Monitoring	2.5 $\mu\text{A}$ Typ Supply Current, Adjustable Threshold and Hysteresis
LT6700	Dual Micropower Comparator with 400mV Reference	1.4V to 18V Supply Voltage, 6.5 $\mu\text{A}$ Typical Supply Current

## Looking for pricing, stock, or lifecycle information?

Click below to explore more details on WIN SOURCE:

- ⊖ [View LT6703HVIS5-2#TRMPBF on WIN SOURCE](#)
- ⊖ [Analog Devices Inc. Information](#)

## Optimize Your Supply Chain with WIN SOURCE Solutions

- ✓ Global Sourcing Solution
- ✓ Obsolete Management
- ✓ Cost Control Management
- ✓ Shortage Management
- ✓ Alternative Solution
- ✓ Excess Inventory Management