

Structure : Silicon Monolithic Integrated Circuit

Product : Band-pass filter for spectrum analyzer for car audio systems

Type :: **BA3835F**

Function : 1. Built-in band pass filter for spectrum analyzer. BA3835F is for 5 bands.  
2. Designed for 5V microcomputer power voltage.

Absolute Maximum Ratings (Ta=25°C)

Parameter	Symbol	Rating	Unit
Power Supply voltage	Vcc	7	V
Power dissipation	Pd	450*	mW
Operating temperature	Topr	-25~+75	°C
Storage temperature	Tstg	-55~+125	°C

\*This value decreases 4.5 mW/°C for Ta=25°C or more.

Operating Voltage Range (Ta=25°C)

Parameter	Symbol	Min.	Typ.	Max.	Unit
Power supply voltage	Vcc	4.5	5.0	6.5	V

Electrical Characteristics

(Unless specified particularly, Ta=25°C, Vcc=5V, Ri=10MΩ, VAIN=-30dBV, SEL=1)

Parameter	Symbol	Limit			Unit	Conditions
		Min.	Typ.	Max.		
Circuit current	Icc	—	8.5	13	mA	VAIN=0V, A, B, C, SEL=0
Maximum output level	VOM	4.0	4.8	—	V	VAIN=-14dBV, Measured at each output
Output offset voltage	VOS	—	30	150	mV	VAIN=0V, SEL=0/1, Measured at each output (cycle time: Ts=50ms)
Standard output level 1	VO1	0.65	1.35	1.70	V	fIN=105Hz, A=0, B=0, C=1
Standard output level 2	VO2	0.65	1.35	1.70	V	fIN=340Hz, A=0, B=1, C=0
Standard output level 3	VO3	0.65	1.35	1.70	V	fIN=1kHz, A=1, B=0, C=0
Standard output level 4	VO4	0.65	1.35	1.70	V	fIN=3.4kHz, A=1, B=1, C=0
Standard output level 5	VO5	0.65	1.35	1.70	V	fIN=10.5kHz, A=1, B=1, C=1

Application example

Note that ROHM cannot provide adequate confirmation of patents.

The product described in this specification is designed to be used with ordinary electronic equipment or devices (such as audio-visual equipment, office-automation equipment, communications devices, electrical appliances, and electronic toys).

Should you intend to use this product with equipment or devices which require an extremely high level of reliability and the malfunction of which would directly endanger human life (such as medical instruments, transportation equipment, aerospace machinery, nuclear-reactor controllers, fuel controllers and other safety devices), please be sure to consult with our sales representative in advance.

Parameter	Symbol	Limit			Unit	Conditions
		Min.	Typ.	Max.		
Input impedance	$R_{IN}$	80	100	120	$k\Omega$	$f_{IN}=1kHz$
Common-mode rejection ratio	CMRR	25	50	—	dB	$f_{IN}=1kHz, V_{AIN}=V_{CIN}$
Logic input high level	$V_{IH}$	2.5	5.0	—	V	—
Logic input low level	$V_{IL}$	—	0	0.5	V	Not applicable in the when item 10 of operation notes applies.
Output response time*1	$T_O$	—	5	10	$\mu sec$	—
Discharge level	DL	—	3	—	dB	Reset pulse width $T_R=10\mu sec$ Typ.*2

\*1 The time from the rise of A, B, C or SEL until the rise of AOUT (90% of peak). If the output selection time is less than this, the output voltage is not guaranteed and the reset pulse is not generated.

\*2 Automatically generated internally based on the output select signal. For the duration that this signal is "H", a resistor is connected to the peak hold capacitor, and the output level drops by -3dB (typ.) for one pulse.

\*3 The Q of the bandpass filter is 3.5

© Not designed for radiation resistance.

Output select logic table

SEL	A	B	C	AOUT
0	x	x	x	GND
1	0	0	0	GND
1	0	0	1	105Hz
1	0	1	0	340Hz
1	0	1	1	GND
1	1	0	0	1kHz
1	1	0	1	GND
1	1	1	0	3.4kHz
1	1	1	1	10.5kHz

x: Don't Care.

Timing chart

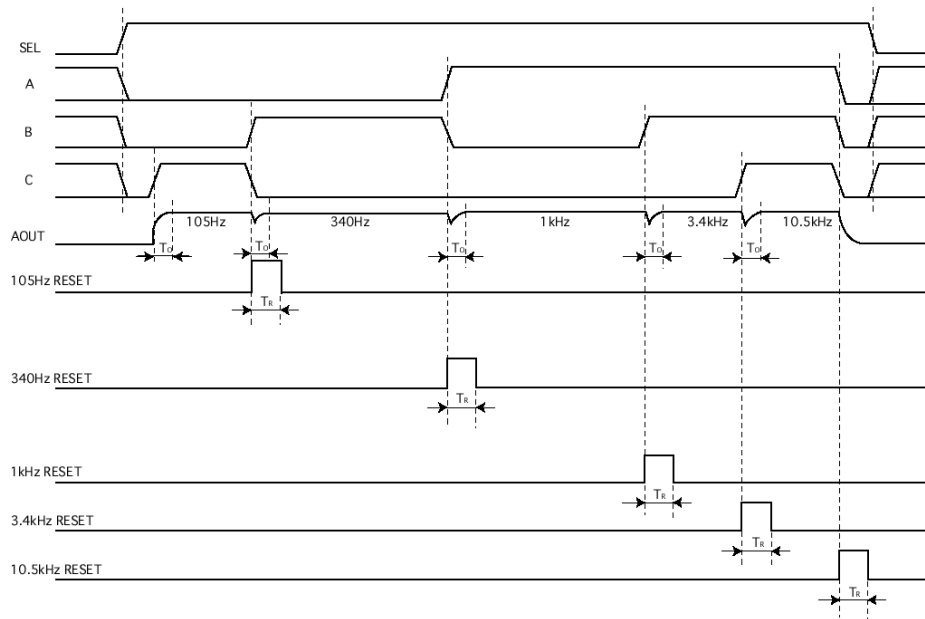

Block Diagram

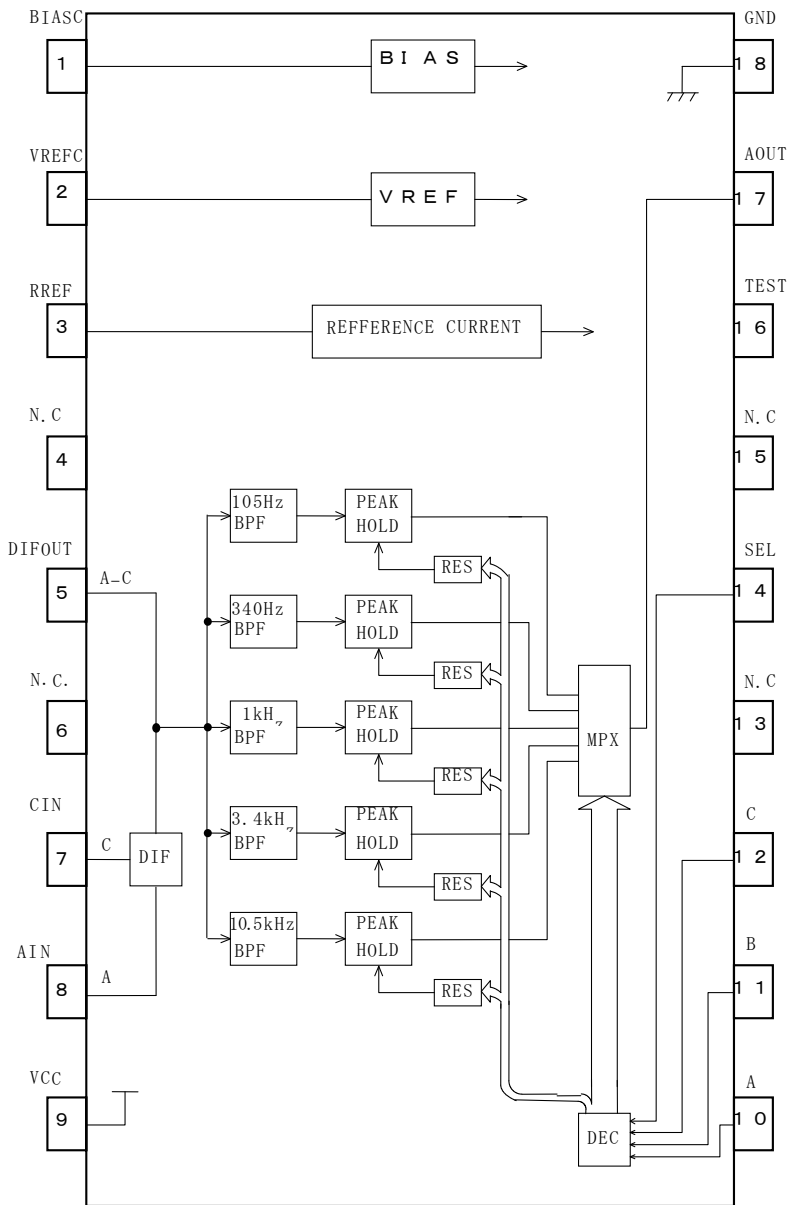

Terminal Number/ Terminal Name

Terminal Number	Terminal Name
1	BIASC
2	VREFC
3	RREF
4	N.C
5	DIFOUT
6	N.C
7	CIN
8	AIN
9	VCC
10	A
11	B
12	C
13	N.C
14	SEL
15	N.C
16	TEST
17	AOUT
18	GND

Outline Dimension

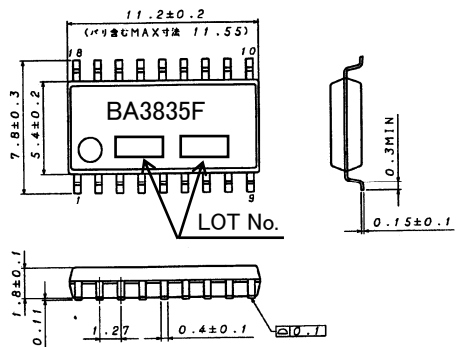

SOP18 (Unit:mm)

Application example

- (1) Numbers and data in entries are representative design values and are not guaranteed values of the items.
- (2) Although we are confident in recommending the sample application circuits, carefully check their characteristics further when using them. When modifying externally attached component constants before use, determine them so that they have sufficient margins by taking into account variations in externally attached components and the Rohm LSI, not only for static characteristics but also including transient characteristics.
- (3) Absolute maximum ratings  
If applied voltage, operating temperature range, or other absolute maximum ratings are exceeded, the LSI may be damaged. Do not apply voltages or temperatures that exceed the absolute maximum ratings. If you think of a case in which absolute maximum ratings are exceeded, enforce fuses or other physical safety measures and investigate how not to apply the conditions under which absolute maximum ratings are exceeded to the LSI.
- (4) GND potential  
Make the GND pin voltage such that it is the lowest voltage even when operating below it. Actually confirm that the voltage of each pin does not become a lower voltage than the GND pin, including transient phenomena.

(5) Thermal design

Perform thermal design in which there are adequate margins by taking into account the allowable power dissipation in actual states of use.

(6) Shorts between pins and misinstallation

When mounting the LSI on a board, pay adequate attention to orientation and placement discrepancies of the LSI. If it is misinstalled and the power is turned on, the LSI may be damaged. It also may be damaged if it is shorted by a foreign substance coming between pins of the LSI or between a pin and a power supply or a pin and a GND.

(7) Operation in strong magnetic fields

Adequately evaluate use in a strong magnetic field, since there is a possibility of malfunction.

(8) Frequency characteristics

The frequency characteristics of this IC are determined by the resistor connected between the R<sub>REF</sub> terminal and GND. For the specification conditions, the value of this resistor is 100kΩ. If it is necessary to set the frequency characteristics accurately, use a variable resistor

(note: all bands will shift together).

(9) Load characteristics

To convert the bias sense output signal to the GND sense signal, the IC performs a V / I conversion, and then an I / V conversion using a 10kΩ resistor (Typ.) for the output. Therefore, if the load circuit connected to the AOUT pin has a MOS structure there is no problem (eg. Microprocessor input port), but if the connected circuit has a low input impedance, it may cause the output level to drop.

(10) External resistor for the control pin

When using a common port for the output select control and FL drive, you must add a diode and resistor as shown in the right figure to prevent the FL drive “L” voltage from destroying the IC.

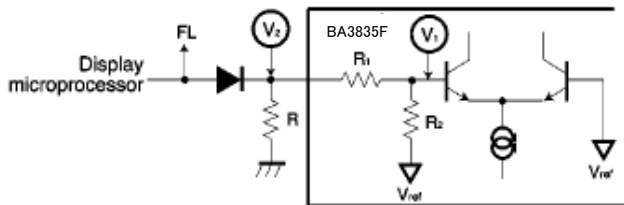

In this case, the “L” voltage applied to the internal comparator input terminal V<sub>1</sub> is given by:

$$V_1 = \frac{R_1 + R}{R_1 + R_2 + R} \times V_{ref}$$

To maintain a noise margin of at least 2.5V with respect to the comparator threshold level V<sub>REF</sub>, the representative values for V<sub>REF</sub>, R<sub>1</sub> and R<sub>2</sub> are 1.5V, 20kΩ, and 10kΩ respectively. This gives:

$$\frac{20k\Omega + R}{20k\Omega + 20k\Omega + R} \times 1.5V + 0.25V < 1.5V$$

And from this, the following condition is obtained:  
R < 30kΩ

In this case, the “L” level voltage V<sub>2</sub> for the IC will be:

$$V_2 < 0.75V$$

(11) Recommended operating ranges

Provided that the IC is operated within the recommended operating conditions and the recommended temperature range, the basic circuit functions are guaranteed. Within these ranges, ratings for electrical characteristics for conditions other than those stipulated cannot be guaranteed, but the inherent function of the band pass filter will be maintained.

(12) Output offset voltage

The relationship between the output offset voltage and the output selection cycle (cycle time) for this IC is shown in Fig.5. The maximum output offset voltage of 150mV that is given in the electrical characteristics table is under the condition that T<sub>s</sub> = 200ms.

When T<sub>s</sub> is greater than 50ms, the graph of the output offset voltage is a straight line at 150mV. When T<sub>s</sub> is below 50ms, due to transient

characteristics of the peak hold circuit, the graph is a line sloping downwards to the right. In other words, the shorter

the cycle, the larger the output offset voltage. Furthermore, the output offset voltage may shift due to soldering or other temperature stresses from the surroundings. Therefore, when setting the spectral analyzer light level, take into consideration the points given above

and make sure that it does not light by mistake during quiescent periods. Use the chart below as a guide for this, and, if necessary, leave even a larger margin.

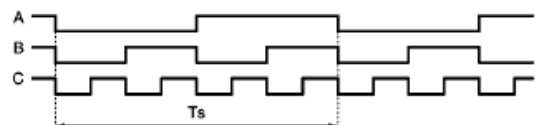
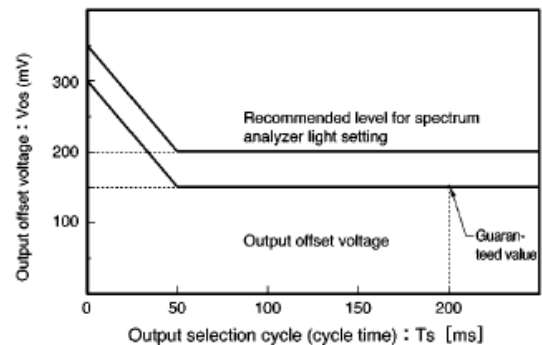

## Notes

No copying or reproduction of this document, in part or in whole, is permitted without the consent of ROHM Co.,Ltd.

The content specified herein is subject to change for improvement without notice.

The content specified herein is for the purpose of introducing ROHM's products (hereinafter "Products"). If you wish to use any such Product, please be sure to refer to the specifications, which can be obtained from ROHM upon request.

Examples of application circuits, circuit constants and any other information contained herein illustrate the standard usage and operations of the Products. The peripheral conditions must be taken into account when designing circuits for mass production.

Great care was taken in ensuring the accuracy of the information specified in this document. However, should you incur any damage arising from any inaccuracy or misprint of such information, ROHM shall bear no responsibility for such damage.

The technical information specified herein is intended only to show the typical functions of and examples of application circuits for the Products. ROHM does not grant you, explicitly or implicitly, any license to use or exercise intellectual property or other rights held by ROHM and other parties. ROHM shall bear no responsibility whatsoever for any dispute arising from the use of such technical information.

The Products specified in this document are intended to be used with general-use electronic equipment or devices (such as audio visual equipment, office-automation equipment, communication devices, electronic appliances and amusement devices).

The Products specified in this document are not designed to be radiation tolerant.

While ROHM always makes efforts to enhance the quality and reliability of its Products, a Product may fail or malfunction for a variety of reasons.

Please be sure to implement in your equipment using the Products safety measures to guard against the possibility of physical injury, fire or any other damage caused in the event of the failure of any Product, such as derating, redundancy, fire control and fail-safe designs. ROHM shall bear no responsibility whatsoever for your use of any Product outside of the prescribed scope or not in accordance with the instruction manual.

The Products are not designed or manufactured to be used with any equipment, device or system which requires an extremely high level of reliability the failure or malfunction of which may result in a direct threat to human life or create a risk of human injury (such as a medical instrument, transportation equipment, aerospace machinery, nuclear-reactor controller, fuel-controller or other safety device). ROHM shall bear no responsibility in any way for use of any of the Products for the above special purposes. If a Product is intended to be used for any such special purpose, please contact a ROHM sales representative before purchasing.

If you intend to export or ship overseas any Product or technology specified herein that may be controlled under the Foreign Exchange and the Foreign Trade Law, you will be required to obtain a license or permit under the Law.





Thank you for your accessing to ROHM product informations.  
More detail product informations and catalogs are available, please contact us.

### ROHM Customer Support System

<http://www.rohm.com/contact/>

## Looking for pricing, stock, or lifecycle information?

Click below to explore more details on WIN SOURCE:

-  [View BA3835F-E2 on WIN SOURCE](#)
-  [Rohm Semiconductor](#) Information

## Optimize Your Supply Chain with WIN SOURCE Solutions

-  Global Sourcing Solution
-  Obsolete Management
-  Cost Control Management
-  Shortage Management
-  Alternative Solution
-  Excess Inventory Management