



**THE DATASHEET OF
BA10393N**



Dual comparators

BA10393 / BA10393F / BA10393N

The BA10393, BA10393F, and BA10393N are dual comparators with open-collector output which allows wired OR connections.

The operating power supply voltage ranges from 2 to 36V for a single power supply and ± 1 to ± 18 V for a dual power supply. The packages are as follows: DIP 8-pin (BA10393), SOP 8-pin (BA10393F), and SIP 8-pin (BA10393N).

●Features

- 1) Wide operating voltage range.
(Single power supply: 2 to 36V, dual power supply: ± 1 to ± 18 V)
- 2) Low current dissipation. (0.4mA typ. at $V_{CC} = 5$ V)
- 3) Low input offset voltage. (25nA typ. at $V_{CC} = 5$ V) and low input offset voltage. (typically ± 1.0 mV at $V_{CC} = 5$ V)
- 4) Wide common-mode input voltage. (0 to $V_{CC} - 1.5$ V)
- 5) Open collector output.
- 6) Compatible with 393 comparators from other manufacturers.

●Block diagram

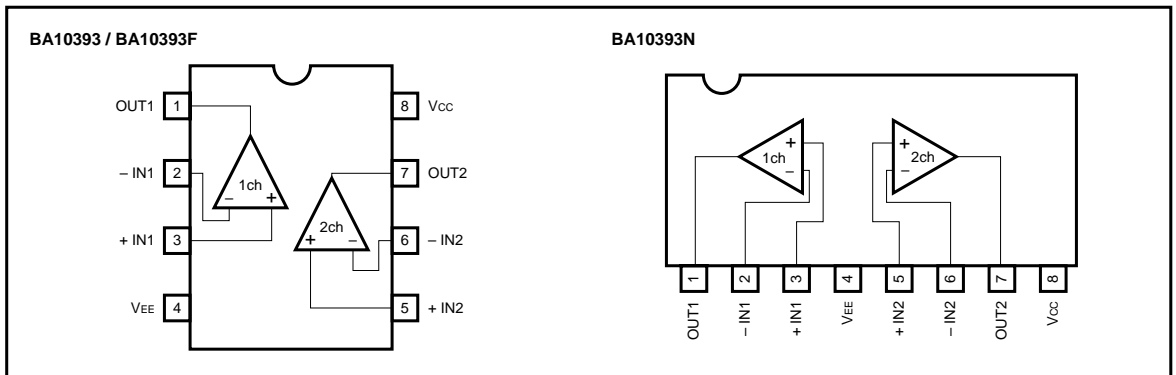

●Internal circuit configuration

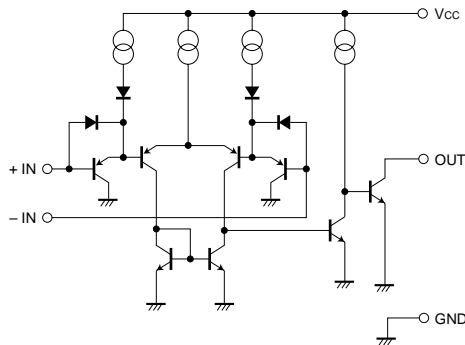

●Absolute maximum ratings (Ta = 25°C)

Parameter	Symbol	Limits			Unit
		BA10393	BA10393F	BA10393N	
Power supply voltage	V _{CC}	36 (± 18)	36 (± 18)	36 (± 18)	V
Power dissipation	P _d	800*	550*	900*	mW
Differential input voltage	V _{ID}	± V _{CC}	± V _{CC}	± V _{CC}	V
Common-mode input voltage	V _I	- 0.3 ~ V _{CC}	- 0.3 ~ V _{CC}	- 0.3 ~ V _{CC}	V
Operating temperature	T _{opr}	- 40 ~ + 85	- 40 ~ + 85	- 40 ~ + 85	°C
Storage temperature	T _{stg}	- 55 ~ + 125	- 55 ~ + 125	- 55 ~ + 125	°C

* Refer to the Pd characteristics diagram.

The values for the BA10393F are those when it is mounted on a glass epoxy PCB (50mm × 50mm × 1.6mm).

●Electrical characteristics (unless otherwise noted, Ta = 25°C, V_{CC} = + 5V)

Parameter	Symbol	Min.	Typ.	Max.	Unit	Conditions
Input offset voltage	V _{IO}	—	± 1	± 5	mV	V _O = 1.4V
Input offset current	I _{IO}	—	± 5	± 50	nA	I _{IN+} - I _{IN-} , V _O = 1.4V
Input bias current	I _B	—	25	250	nA	V _O = 1.4V
Common-mode input voltage	V _{ICM}	0	—	V _{CC} - 1.5	V	
Voltage gain	A _V	93	106	—	dB	R _L = 15kΩ, V _{CC} = 15V
Quiescent current	I _Q	—	0.4	1	mA	R _L = ∞, on All Comparators
Output sink current	I _{sink}	6	16	—	mA	V _{IN-} = + 1V, V _{IN+} = 0V, V _O = 1.5V
Output saturation voltage	V _{OL}	—	250	400	mV	V _{IN-} = + 1V, V _{IN+} = 0V, I _{sink} = 4mA
Output leakage current	I _{leak}	—	0.1	—	nA	V _{IN+} = + 1V, V _{IN-} = 0V, V _O = 5V
Response time	t _r	—	1.3	—	μs	R _L = 5.1kΩ, V _{RL} = 5V

●Electrical characteristic curves

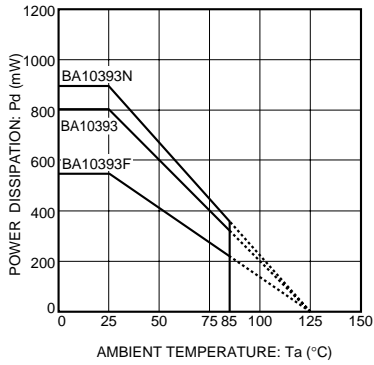

Fig. 1 Power dissipation vs. ambient temperature

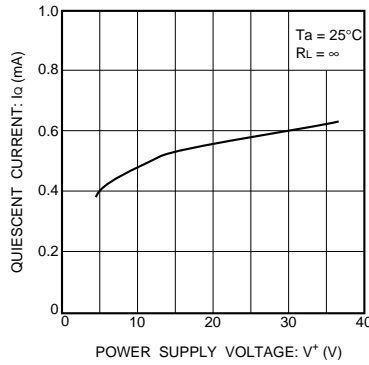

Fig. 2 Quiescent current vs. power supply voltage

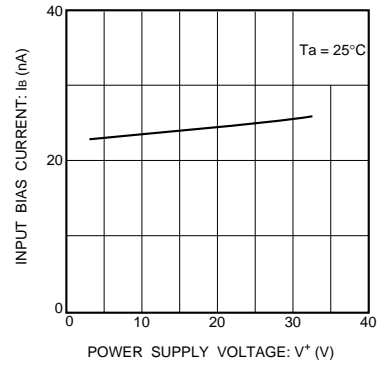

Fig. 3 Input bias current vs. power supply voltage

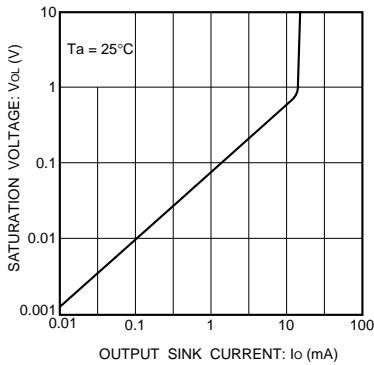

Fig. 4 Output saturation voltage vs. output current

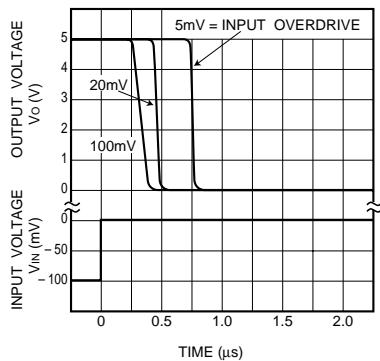

Fig. 5 Propagation characteristics (I)

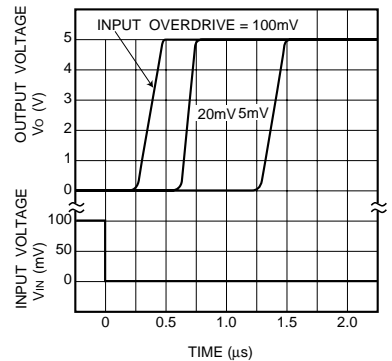

Fig. 6 Propagation characteristics (II)

●Operation notes

(1) Handling unused circuits

If a circuit is not in use, we recommend connecting it as shown in Figure 7, so that its input is connected to the potential within the in-phase input voltage range (V_{ICM}) and the output is left open.

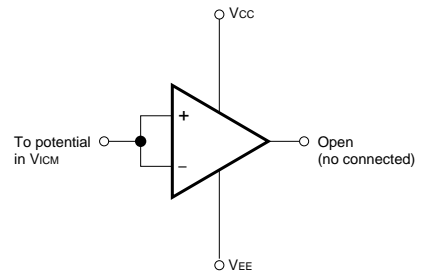
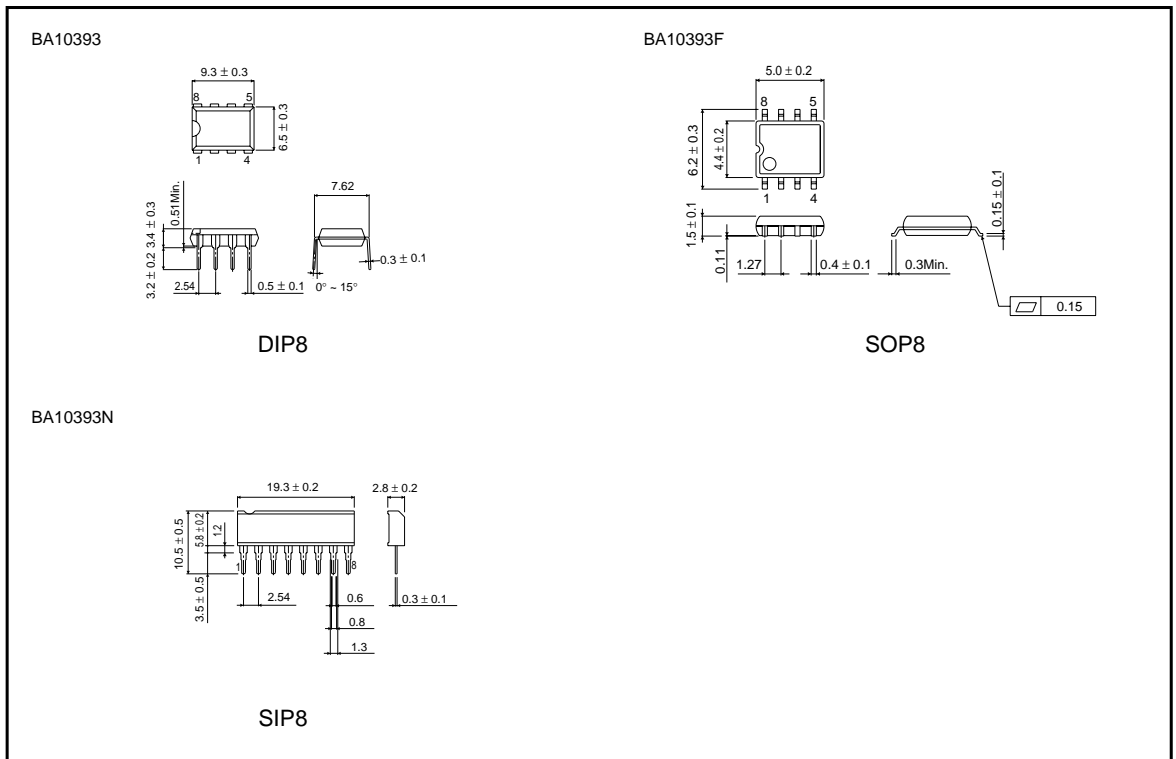

Fig. 7 Example of unused circuit connection

●External dimensions (Units: mm)



Notes

- No technical content pages of this document may be reproduced in any form or transmitted by any means without prior permission of ROHM CO.,LTD.
- The contents described herein are subject to change without notice. The specifications for the product described in this document are for reference only. Upon actual use, therefore, please request that specifications to be separately delivered.
- Application circuit diagrams and circuit constants contained herein are shown as examples of standard use and operation. Please pay careful attention to the peripheral conditions when designing circuits and deciding upon circuit constants in the set.
- Any data, including, but not limited to application circuit diagrams information, described herein are intended only as illustrations of such devices and not as the specifications for such devices. ROHM CO.,LTD. disclaims any warranty that any use of such devices shall be free from infringement of any third party's intellectual property rights or other proprietary rights, and further, assumes no liability of whatsoever nature in the event of any such infringement, or arising from or connected with or related to the use of such devices.
- Upon the sale of any such devices, other than for buyer's right to use such devices itself, resell or otherwise dispose of the same, no express or implied right or license to practice or commercially exploit any intellectual property rights or other proprietary rights owned or controlled by
- ROHM CO., LTD. is granted to any such buyer.
- Products listed in this document use silicon as a basic material.
Products listed in this document are no antiradiation design.

The products listed in this document are designed to be used with ordinary electronic equipment or devices (such as audio visual equipment, office-automation equipment, communications devices, electrical appliances and electronic toys).

Should you intend to use these products with equipment or devices which require an extremely high level of reliability and the malfunction of which would directly endanger human life (such as medical instruments, transportation equipment, aerospace machinery, nuclear-reactor controllers, fuel controllers and other safety devices), please be sure to consult with our sales representative in advance.



About Export Control Order in Japan

Products described herein are the objects of controlled goods in Annex 1 (Item 16) of Export Trade Control Order in Japan.







In case of export from Japan, please confirm if it applies to "objective" criteria or an "informed" (by MITI clause) on the basis of "catch all controls for Non-Proliferation of Weapons of Mass Destruction.

Looking for pricing, stock, or lifecycle information?

Click below to explore more details on WIN SOURCE:

-  [View BA10393N on WIN SOURCE](#)
-  [Rohm Semiconductor Information](#)

Optimize Your Supply Chain with WIN SOURCE Solutions

-  Global Sourcing Solution
-  Obsolete Management
-  Cost Control Management
-  Shortage Management
-  Alternative Solution
-  Excess Inventory Management