



**THE DATASHEET OF
RFBPB2012090A7T**





PSA PASSIVE SYSTEM ALLIANCE
WALSIN TECHNOLOGY CORPORATION

RF Devices & Customer made Antenna

www.passivecomponent.com

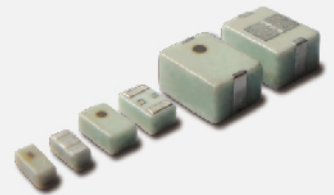

Product Portfolio



Multilayer Ceramic Capacitors



Chip Resistors



Disc Capacitors



Inductors



RF Filters



Antenna



Antenna Switch & Module



MOV & MLV

IEC-63 Nominal Resistance / Capacitance

E1	100																							
E3	100			220			470																	
E6	100	150	220	330	470	680																		
E12	100	120	150	180	220	270	330	390	470	560	680	820												
E24	100	110	120	130	150	160	180	200	220	240	270	300	330	360	390	430	470	510	560	620	680	750	820	910
E96	100	102	121	124	147	150	178	182	215	221	261	267	316	324	383	392	464	475	562	576	681	698	825	845
	105	107	127	130	154	158	187	191	226	232	274	280	332	340	402	412	487	499	590	604	715	732	866	887
	110	113	133	137	162	165	196	200	237	243	287	294	348	357	422	432	511	523	619	634	750	768	909	931
	115	118	140	143	169	174	205	210	249	255	301	309	365	374	442	453	536	549	649	665	787	806	953	976

E6: $\sqrt[6]{10} \approx 1.46$ E12: $\sqrt[12]{10} \approx 1.21$

E1 series resistance: 1Ω, 10Ω, 100Ω, 1000Ω, 10000Ω, 100000Ω

INDEX

Subject	Page
ORDERING CODE	1~5
CHIP ANTENNA	5~12
■ 1.575GHz GPS BAND WORKING FREQUENCY	
■ Bluetooth/WiFi BAND WORKING FREQUENCY	
■ WiMAX BAND WORKING FREQUENCY	
■ UHF BAND WORKING FREQUENCY	
HIGH FREQUENCY MULTILAYER BAND PASS FILTER	13~29
■ 2.4GHz BAND WORKING FREQUENCY	
■ WiMAX BAND WORKING FREQUENCY	
■ 5GHz BAND WORKING FREQUENCY	
■ 1558 ~ 1606 MHz GNSS Band Applications	
■ 860~960MHz/1805~2025 MHz Band Application	
■ MoCA / Docsis Application	
■ LTE BAND Application	
HIGH FREQUENCY MULTILAYER BALANCED FILTER	30~33
■ 2.4GHz BAND WORKING FREQUENCY	
HIGH FREQUENCY MULTILAYER LOW PASS FILTER	34~43
■ GSM850/900GHz BAND WORKING FREQUENCY	
■ DCS/PCS BAND WORKING FREQUENCY	
■ 2.4GHz BAND WORKING FREQUENCY	
■ 5GHz BAND WORKING FREQUENCY	
■ LTE BAND APPLICATION	
■ MoCA Application	
HIGH FREQUENCY MULTILAYER HIGH PASS FILTER	44~45
■ 2496 ~ 2690 MHz BAND WORKING FREQUENCY	
■ 5GHz BAND WORKING FREQUENCY	
■ MoCA Application	
BALUN TRANSFORMERS	46~55
■ ISM Band 2.4GHz Application	
■ ISM Band 5GHz Application	
■ LTE Band Application	
■ GSM 850/ GSM 900/ DCS1800/ PCS1900 Application	
DIPLEXER	56~66
■ ISM Band 2.4GHz/5GHz Application	
■ GPS 1.575GHz/ISM 2.4GHz/5GHz Band Application	
■ 892 MHz & 1.94GHz Band Working Frequency	
TRIPLEXER	67~70
■ GPS 1.575GHz/ISM 2.4GHz/5GHz BandRF Application	
COMMON MODE FILTER	71
■ DISCRETE CMF for HIGH SPEED TRANSMISSION LINES· USB2.0 · IEEE1394 · LVDS(mini)	
COUPLER	72~76
■ ISM Band 2.4GHz Application	
■ ISM Band 2.4/5GHz Application	
■ LTE BAND Application	
SAW FILTER	77~85
ANTENNA SWITCH (GPIO)	86~87
ANTENNA SWITCH (MIPI)	88~89
ANTENNA SWITCH (LTE Antenna Tuner- GPIO)	90
ANTENNA SWITCH (Network-GPIO)	91
Customer made Antenna	92~102
■ Dipole Antenna (None Cable and With Cable)	
■ PCB Antenna	
■ FPA Antenna	
■ Metal Antenna	
■ NFC Antenna	
■ Connector	

*The specifications are subject to change or our products in it may be discontinued without advance notice. Please check with our sales representatives or product engineers before ordering.

*This catalog has only typical specifications because there is no space for detailed specifications. Therefore, please approve our product specifications or transact the approval sheet for product specifications before ordering.

■ **CHIP ANTENNA**

RF	ANT	321612	0	A	5	T
Type code	Product code	Dimension code	Unit of dimension	Application	Specification	Packing
RF/RG: device	ANT : Antenna FRA : Free Antenna ECA : SMD Antenna	Per 2 digits of Length, Width, Thickness 321612 = Length =32 Width = 16 Thickness = 12	0 : 0.1 mm 1 : 1.0 mm	A : 2.4GHz ISM Band E : GPS 1.5GHz L : 2.4/5.2/5.8GHz Tri Band W : WiMAX	Code from 0-9 dependent on different electrical specification	T: 7" Reeled G: 13" Reeled

■ **HIGH FREQUENCY MULTILAYER BAND PASS FILTER**

RF	BPF	322515	0	A	4	T
Type code	Product code	Dimension code	Unit of dimension	Application	Specification	Packing
RF device	BPF : Band Pass Filter	Per 2 digits of Length, Width, Thickness 322515 = Length =32 Width = 25 Thickness = 15	0 : 0.1 mm 1 : 1.0 mm	A : 2.4GHz ISM Band W : WiMAX K : ISM 5.2/5.8 Dual Band	Code from 0-9 dependent on different electrical specification	T: 7" Reeled G: 13" Reeled

■ **HIGH FREQUENCY MULTILAYER BALANCED FILTER**

RF	BPB	252009	0	A	7	T
Type code	Product code	Dimension code	Unit of dimension	Application	Specification	Packing
RF/RG: device	BPB : Balanced Type Band Pass Filter	Per 2 digits of Length, Width, Thickness 252009 = Length =25 Width = 20 Thickness = 09	0 : 0.1 mm 1 : 1.0 mm	A : 2.4GHz ISM Band W : WiMAX	Code from 0-9 dependent on different electrical specification	T: 7" Reeled G: 13" Reeled

■ **HIGH FREQUENCY MULTILAYER LOW PASS FILTER**

RF	LPF	201211	0	A	0	T
Type code	Product code	Dimension code	Unit of dimension	Application	Specification	Packing
RF device	LPF : Low Pass Filter	Per 2 digits of Length, Width, Thickness 201210 = Length =20 Width = 12 Thickness = 11	0 : 0.1 mm 1 : 1.0 mm	A : 2.4GHz ISM Band K : ISM 5.2/5.8 Dual Band	Code from 0-9 dependent on different electrical specification	T: 7" Reeled G: 13" Reeled

■ **HIGH FREQUENCY MULTILAYER HIGH PASS FILTER**

RF	HPF	252009	0	L	0	T
Type code	Product code	Dimension code	Unit of dimension	Application	Specification	Packing
RF device	HPF : High Pass Filter	Per 2 digits of Length, Width, Thickness 252009 = Length =2.5 Width = 2.0 Thickness = 0.9	0 : 0.1 mm 1 : 1.0 mm	L : 2.4/4.9/5.2/5.8GHz Multiband Application	Code from 0-9 dependent on different electrical specification	T: 7" Reeled G: 13" Reeled

■ **BALUN TRANSFORMERS**

RF	BLN	201208	0	A	4	T
Type code	Product code	Dimension code	Unit of dimension	Application	Specification	Packing
RF/RG: device	BLN : BALUN	Per 2 digits of Length, Width, Thickness 201208 = Length =20 Width = 12 Thickness = 08	0 : 0.1 mm 1 : 1.0 mm	A : 2.4GHz ISM Band K : ISM 5.2/5.8 Dual Band	Code from 0-9 dependent on different electrical specification	T: 7" Reeled G: 13" Reeled

■ DIPLEXER

RF	DIP	201210	0	L	0	T
Type code	Product code	Dimension code	Unit of dimension	Application	Specification	Packing
RF device	DIP : Diplexer	Per 2 digits of Length, Width, Thickness 201210 = Length =20 Width = 12 Thickness = 10	0 : 0.1 mm 1 : 1.0 mm	L : 2.4/4.9/5.2/5.8GHz Multiband Application	Code from 0-9 dependent on different electrical specification	T : 7" Reeled G:13" Reeled

■ TRIPLEXER

RF	TIP	2109	A	T	M0T63
Type code	Product code	Dimension code	Pin Define	Application	Specification
RF device	TIP : Triplexer	Per 2 digits of Length, Width, Thickness e.g. : 21 = Length 2.0 mm, Width 1.2 mm, 09= Thickness 0.9 mm	Design Code	T: GPS/ ISM 2.4GHz/5 GHz	Design Code

■ COMMON MODE FILTER

RF	CMF	122010	0	M	3	T
Type code	Product code	Dimension code	Unit of dimension	Application	Specification	Packing
RF/RG: device	CMF : Common Mode Filter	Per 2 digits of Length, Width. 122010 = Length =12 Width = 20 Thickness = 10	0 : 0.1 mm 1 : 1.0 mm	M: USB 2.0/ IEEE1394	Code from 0-9 dependent on different electrical specification	T : 7" Reeled

■ COUPLER

RF	CPL	18	10	B	2450	T
Type code	Product code	Dimension code	Coupling Factor	Unit	Application	Packing
RF device	Coupler	e.g. : 18 = Length 16, Width 08, 15= Length 10, Width 05,	10 dB	dB	2.4 GHZ ISM Band	T : 7" Reeled

■ SAW FILTER

SF	1411	2595	B38	03	T
Product code	Dimension code	Frequency	Application	Serial Number	Packing
SF:SAW Filter DF:SAW DUPLEXER	Per 2 digits of Length, Width 1411= Length 1.4mm Width 1.1mm	2595:Center Freq (2595MHz)	B38:Band38	Design Code	T: 7" Reeled

■ ANTENNA SWITCH

RF	ASW	D	H2418A	T
Type code	Product code	Application	Serial Number	Packing
RF device	ASW: Antenna Switch	D: SP8T	Design Code	T: 7" Reeled

■ ANTENNA SWITCH MODULE

RM	ASM	N	T1492A	T
Type code	Product code	Application	Serial Number	Packing
RM: Walsin RF Module Device	ASM: Antenna Switch Module	N: SP16T	Design Code	T: 7" Reeled

■ **Dipole Antenna**

RF	DPA	8709	00	S	B	A	B	8	01
Type code	Product code	Dimension code	Cable Length code	Connector Brand code	Type of Connector code	Application code	Project status code	Wire Diameter code	Project code
RF device	DPA : Dipole Antenna	Per 2 digits of Length, Width 8709 = Length = 87 Width = 9.95	2 digits for cable length 10= None Cable	A: N C:MCX D:IPEX III E: IPEX IV F: IPEX A13 H: Hirose I: IPEX K:F M: MMCX S: SMA T: TNC U:MURATA N: None	A: Reverse Female B: Reverse Male F: Female M: Male N: None	0: 0GHz 5: 5 GHz A: 2.4GHz ISM band B: GSM 900/1800 dual band G: GPS band L: 2.4/5.2/5.8 GHz tri-band T:LTE band U:UHF W: WCDMA band	B: MP T:During Test X: Pile Run	0:None 1:Ø0.81 2:Ø1.32 3:Ø1.13 4:Low LossØ1.13 5:Ø0.50 6:RG316 7:Ø1.37 8:RG178 9:Low LossØ1.37 A:RG174 B:1.5C-2V	01-99 series number

■ **PCB Antenna**

RF	PCA	4305	10	N	N	A	B	4	01
Type code	Product code	Dimension code	Cable Length code	Connector Brand code	Type of Connector code	Application code	Project status code	Wire Diameter code	Project code
RF device	PCA : PCB Antenna	Per 2 digits of Length, Width 4305 = Length = 43 Width = 5	2 digits for cable length 10= Cable Length: 10cm	A: N C:MCX D:IPEX III E: IPEX IV F: IPEX A13 H: Hirose I: IPEX K:F M: MMCX S: SMA T: TNC U:MURATA N: None	A: Reverse Female B: Reverse Male F: Female M: Male N: None	0: 0GHz 5: 5 GHz A: 2.4GHz ISM band B: GSM 900/1800 dual band G: GPS band L: 2.4/5.2/5.8 GHz tri-band T:LTE band U:UHF W: WCDMA band	B: MP T:During Test X: Pile Run	0:None 1:Ø0.81 2:Ø1.32 3:Ø1.13 4:Low LossØ1.13 5:Ø0.50 6:RG316 7:Ø1.37 8:RG178 9: Low LossØ1.37 A:RG174 B:1.5C-2V	01-99 series number

■ **FPA Antenna**

RF	FPA	3025	10	I	M	A	B	3	01
Type code	Product code	Dimension code	Cable Length code	Connector Brand code	Type of Connector code	Application code	Project status code	Wire Diameter code	Project code
RF device	FPA : FPA Antenna	Per 2 digits of Length, Width 3025 = Length = 30 Width = 25	2 digits for cable length 10= Cable Length: 10cm	A: N C:MCX D:IPEX III E: IPEX IV F: IPEX A13 H: Hirose I: IPEX K:F M: MMCX S: SMA T: TNC U:MURATA N: None	A: Reverse Female B: Reverse Male F: Female M: Male N: None	0: 0GHz 5: 5 GHz A: 2.4GHz ISM band B: GSM 900/1800 dual band G: GPS band L: 2.4/5.2/5.8 GHz tri-band T:LTE band U:UHF W: WCDMA band	B: MP T:During Test X: Pile Run	0:None 1:Ø0.81 2:Ø1.32 3:Ø1.13 4:Low LossØ1.13 5:Ø0.50 6:RG316 7:Ø1.37 8:RG178 9: Low LossØ1.37 A:RG174 B:1.5C-2V	01-99 series number

■ **Metal Antenna**

RF	MTA	3109	10	I	M	L	B	7	01
Type code	Product code	Dimension code	Cable Length code	Connector Brand code	Type of Connector code	Application code	Project status code	Wire Diameter code	Project code
RF device	MTA : Metal Antenna	Per 2 digits of Length, Width 3109 = Length = 31 Width = 9	2 digits for cable length 10= Cable Length: 10cm	A: N C:MCX D:IPEX III E: IPEX IV F: IPEX A13 H: Hirose I: IPEX K:F M: MMCX S: SMA T: TNC U:MURATA N: None	A: Reverse Female B: Reverse Male F: Female M: Male N: None	0: 0GHz 5: 5 GHz A: 2.4GHz ISM band B: GSM 900/1800 dual band G: GPS band L: 2.4/5.2/5.8 GHz tri-band T:LTE band U:UHF W: WCDMA band	B: MP T:During Test X: Pile Run	0:None 1:Ø0.81 2:Ø1.32 3:Ø1.13 4:Low LossØ1.13 5:Ø0.50 6:RG316 7:Ø1.37 8:RG178 9: Low LossØ1.37 A:RG174 B:1.5C-2V	01-99 series number

■ **Cable Assembly**

RF	CBA	1613	10	I	M	3	B	7	01
Type code	Product code	Dimension code	Cable Length code	Connector Brand code	Type of Connector code	Application code	Project status code	Wire Diameter code	Project code
RF device	CBA : Cable Assembly	Per 2 digits of Length, Width 1613 = Length = 16.8 Width = 13.7	2 digits for cable length 10= Cable Length: 10cm	A: N C:MCX D:IPEX III E: IPEX IV F: IPEX A13 H: Hirose I: IPEX K:F M: MMCX S: SMA T: TNC U:MURATA N: None	A: Reverse Female B: Reverse Male F: Female M: Male N: None	0: 0GHz 3: 3GHz 6: 6GHz	B: MP T:During Test X: Pile Run	0:None 1:Ø0.81 2:Ø1.32 3:Ø1.13 4:Low LossØ1.13 5:Ø0.50 6:RG316 7:Ø1.37 8:RG178 9: Low LossØ1.37 A:RG174 B:1.5C-2V	01-99 series number

■ **Connector**

RF	CON	0201	00	D	F	6	B	0	01
Type code	Product code	Dimension code	Cable Length code	Connector Brand code	Type of Connector code	Application code	Project status code	Wire Diameter code	Project code
RF device	CON : Connector	Per 2 digits of Length, Width 0201 = Length = 2.05 Width = 1.40	2 digits for cable length 00= None Cable	A: N C:MCX D:IPEX III E: IPEX IV F: IPEX A13 H: Hirose I: IPEX K:F M: MMCX S: SMA T: TNC U:MURATA N: None	A: Reverse Female B: Reverse Male F: Female M: Male N: None	0: 0GHz 3: 3GHz 6: 6GHz	B: MP T:During Test X: Pile Run	0:None 1:Ø0.81 2:Ø1.32 3:Ø1.13 4:Low LossØ1.13 5:Ø0.50 6:RG316 7:Ø1.37 8:RG178 9: Low LossØ1.37 A:RG174 B:1.5C-2V	01-99 series number

■ **NFC Antenna**

RF	NFC	0201	00	N	N	N	B	0	01
Type code	Product code	Dimension code	Cable Length code	Connector Brand code	Type of Connector code	Application code	Project status code	Wire Diameter code	Project code
RF device	NFC : Near Field Communication Antenna	Per 2 digits of Length, Width 0201 = Length = 53.7 Width = 39.7	2 digits for cable length 00= None Cable	A: N C:MCX D:IPEX III E: IPEX IV F: IPEX A13 H: Hirose I: IPEX K:F M: MMCX S: SMA T: TNC U:MURATA N: None	A: Reverse Female B: Reverse Male F: Female M: Male N: None	N: NFC	B: MP T:During Test X: Pile Run	0:None 1:Ø0.81 2:Ø1.32 3:Ø1.13 4:Low LossØ1.13 5:Ø0.50 6:RG316 7:Ø1.37 8:RG178 9: Low LossØ1.37 A:RG174 B:1.5C-2V	01-99 series number

■ **WPC Antenna**

RF	WPC	5830	00	N	N	N	B	0	01
Type code	Product code	Dimension code	Cable Length code	Connector Brand code	Type of Connector code	Application code	Project status code	Wire Diameter code	Project code
RF device	WPC : Wireless Power Charging Antenna	Per 2 digits of Length, Width 5830 = Length = 58 Width = 30	2 digits for cable length 00= None Cable	A: N C:MCX D:IPEX III E: IPEX IV F: IPEX A13 H: Hirose I: IPEX K:F M: MMCX S: SMA T: TNC U:MURATA N: None	A: Reverse Female B: Reverse Male F: Female M: Male N: None	N: NFC	B: MP T:During Test X: Pile Run	0:None 1:Ø0.81 2:Ø1.32 3:Ø1.13 4:Low LossØ1.13 5:Ø0.50 6:RG316 7:Ø1.37 8:RG178 9: Low LossØ1.37 A:RG174 B:1.5C-2V	01-99 series number

Remark:

1. Central Frequency should be defined after customers' application approval.

CHIP ANTENNA

■ STRUCTURE AND PIN ASSOCIATED

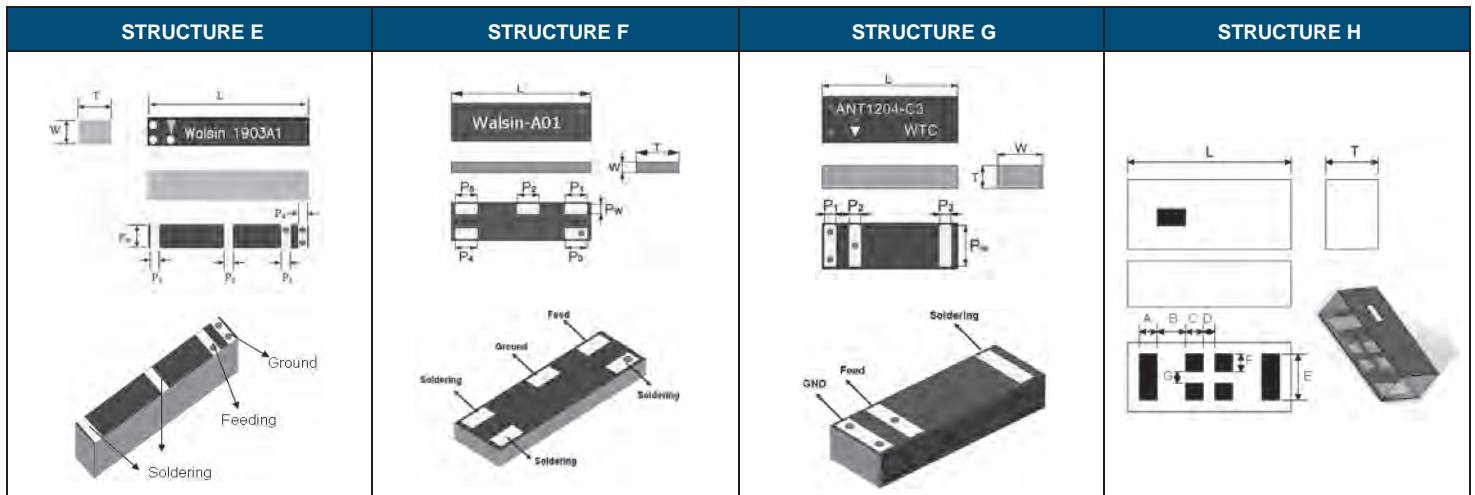
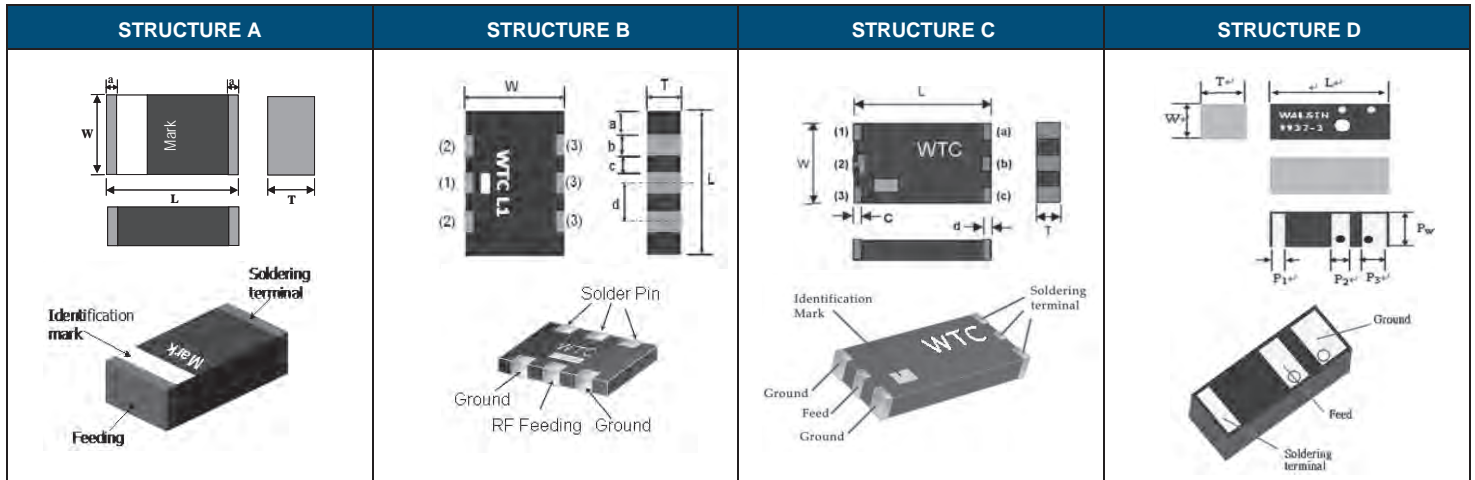

■ STRUCTURE AND DIMENSION

Unit: mm

Structure\Dimension	L	W	T	a	b	c	d	1	2	3
A	10 ± 0.20	3.2 ± 0.20	0.8 ± 0.10	0.8 ± 0.10						
	2.0 ± 0.20	1.25 ± 0.20	0.90 ± 0.10	0.25 ± 0.15	-	-	-	-	-	-
	3.20 ± 0.20	1.60 ± 0.20	0.60 ± 0.10	0.25 ± 0.20	-	-	-	-	-	-
			1.20 ± 0.10	0.25 ± 0.15	-	-	-	-	-	-
	5.20 ± 0.20	2.00 ± 0.20	1.30 ± 0.20	0.40 ± 0.20	-	-	-	-	-	-
			1.15 ± 0.10	0.40 ± 0.25	-	-	-	-	-	-
	5.8 ± 0.1 - 0.3	3.0 ± 0.1 - 0.3	1.1 ± 0.2 - 0.1	0.4 ± 0.25	-	-	-	-	-	-
	8.00 ± 0.20	1.05 ± 0.20	0.80 ± 0.10	0.30 ± 0.20	-	-	-	-	-	-
	9.10 ± 0.20	3.00 ± 0.20	2.00 ± 0.10	0.20 ± 0.20	-	-	-	-	-	-
	9.50 ± 0.20	2.10 ± 0.20	1.15 ± 0.10	0.50 ± 0.30	-	-	-	-	-	-
	1.60 ± 0.20	0.80 ± 0.20	0.50 ± 0.10	0.10 ± 0.05						
2.00 ± 0.20	1.20 ± 0.20	0.50 ± 0.10	0.15 ± 0.05							
12.00 ± 0.15	4.00 ± 0.15	1.60 ± 0.15	4.00 ± 0.15	0.80 ± 0.10	10.40 ± 0.15					
B	5.9 ± 0.3	5.1 ± 0.3	1.1 ± 0.1	0.45 ± 0.2	1.0 ± 0.2	1.0 ± 0.2	2.0 ± 0.2	1.0 ± 0.2	1.0 ± 0.2	1.0 ± 0.2
C	7.6 ± 0.3	3.5 ± 0.2	1.1 ± 0.1	0.8 ± 0.2	0.8 ± 0.2	0.8 ± 0.2	0.5 ± 0.2	0.5 ± 0.2	0.8 ± 0.2	0.50 ± 0.2

Structure\Dimension	L	W	T	PW	P1	P2	P3	P4	P5
D	9.90±0.15	3.70±0.15	3.80±0.20	3.48±0.10	1.4±0.10	1.9±0.10	2.4±0.15	-	-
E	19.0±0.15	3.00±0.15	3.80±0.20	3.00±0.10	1.0±0.10	1.0±0.10	1.0±0.10	1.0±0.10	-
F	12.8±0.15	3.90±0.15	1.10±0.10	1.00±0.10	2.0±0.10	2.0±0.10	2.0±0.10	2.0±0.10	2.0±0.10
G	12.0±0.15	4.00±0.15	2.00±0.10	3.60±0.10	1.0±0.10	1.0±0.10	1.0±0.10	-	-
H	9.90±0.15	3.70±0.15	3.80±0.20	3.48±0.10	1.4±0.10	1.9±0.10	2.4±0.15	-	-

■ ELECTRICAL SPECIFICATION

1.575GHz BAND WORKING FREQUENCY

Part Number	Frequency Range (GHz)	Azimuth Beamwidth (MHz)	Gain (dBi)	VSWR (max.)	Impedance (Ω)	Polarization	Size (mm)	Structure
RFANT5830110EOT	1.575	Omni-directional	0 ~ 2	2.0	50	Linear	5.80x3.00x1.10	A
RFECA1003011EOT	1.575	Omni-directional	2 ~ 3	2.0	50	Linear	10.0x3.20x0.80	A
RFECA3216060E=T	1.575	Omni-directional	3	2.0	50	Linear	3.20x1.60x0.60	A

Bluetooth/WiFi BAND WORKING FREQUENCY

Part Number	Frequency Range (GHz)	Azimuth Beamwidth (MHz)	Gain (dBi)	VSWR (max.)	Impedance (Ω)	Polarization	Size (mm)	Structure
RFECA3216060L1T	2.4-2.5 5.25-5.85	Omni-directional	0.6/2	2.1	50	Linear	3.20x1.60x0.60	A
RFANT6050110L0T	2.4-2.5 4.9-5.9	Omni-directional	4	2.0	50	Linear	5.90x5.10x1.10	B
RFANT6050110L1T	2.4-2.5 4.9-5.9	Omni-directional	4	2.0	50	Linear	5.90x5.10x1.10	B
RFANT2012090AOT	2.4-2.5	Omni-directional	1.72	2.0	50	Linear	2.00x1.25x0.90	A
RFANT3216120A1T	2.4-2.5	Omni-directional	2	2.0	50	Linear	3.20x1.60x1.20	A
RFANT3216120A3T	2.4-2.5	Omni-directional	2	2.0	50	Linear	3.20x1.60x1.20	A
RFANT3216120A5T	2.4-2.5	Omni-directional	2	2.0	50	Linear	3.20x1.60x1.20	A
RFANT5220110A0T	2.4-2.5	Omni-directional	2	2.0	50	Linear	5.20x2.00x1.10	A
RFANT5220110A2T	2.4-2.5	Omni-directional	2	2.0	50	Linear	5.20x2.00x1.10	A
RFANT7635110A1T	2.4-2.5	Omni-directional	0 ~ 2	2.0	50	Linear	7.60x3.50x1.10	C
RFANT8010080A3T	2.4-2.5	Omni-directional	2	2.0	50	Linear	8.00x1.00x0.80	A
RFANT9520120A0T	2.4-2.5	Omni-directional	2	2.0	50	Linear	9.50x2.00x1.20	A
RFECA3216060A1T	2.4-2.5	Omni-directional	2	2.1	50	Linear	3.20x1.60x0.60	A
RFECA3216060K1T	4.9-5.85	Omni-directional	2.8	2.0	50	Linear	3.20x1.60x0.60	A
RFANT9030200A1T	2.4-2.4835	Omni-directional	2	2.1	50	Linear	9.00x 3.00x2.00	A
RGFRA1903041A1T	2.4-2.5	Omni-directional	2	2.0	50	Linear	19.0x3.00x3.80	E
RGFRA1903041A5T	2.4-2.5	Omni-directional	2	2.0	50	Linear	19.0x3.00x3.80	E
RGFRA9937380A3T	2.4-2.55	Omni-directional	2	2.0	50	Linear	9.90x3.70x3.80	D
RGFRA1304011A1T	2.4-2.5	Omni-directional	2	2.1	50	Linear	12.8x3.90x1.10	F
RGFRA1204021A1T	2.4-2.5	Omni-directional	2	2.0	50	Linear	12.0x4.00x2.00	G
RFANT2012090AOT	2.4-2.5	Omni-directional	2	2.0	50	Linear	2.00x1.25x0.90	A
RFECA1608050A0T	2.4-2.5	Omni-directional	0.7	3.0	50	Linear	1.60x0.80x0.50	A
RFECA2012050A3T	2.4-2.5	Omni-directional	0.29	2.6	50	Linear	2.00x1.20x0.5	A

WiMAX BAND WORKING FREQUENCY

Part Number	Frequency Range (GHz)	Azimuth Beamwidth (MHz)	Gain (dBi)	VSWR (max.)	Impedance (Ω)	Polarization	Size (mm)	Structure
RFANT32162G6W0T	2.5-2.69	Omni-directional	1	3.0	50	Linear	3.20x1.60x1.20	A
RFANT32163G5W0T	3.3-3.8	Omni-directional	2-3	2.0	50	Linear	3.20x1.60x1.20	A

UHF BAND WORKING FREQUENCY

Part Number	Frequency Range (MHz)	Azimuth Beamwidth (MHz)	Gain (dBi)	VSWR (max.)	Impedance (Ω)	Polarization	Size (mm)	Structure
RGFRA1204011DCT	900-930	Omni-directional	1	2.0	50	Linear	12.00x4.00x1.60	A
RGFRA1204011DET	855-885	Omni-directional	1	2.0	50	Linear	12.00x4.00x1.60	A

■ For more information, please contact with local sales representative

■ All specifications are subject to change without notice





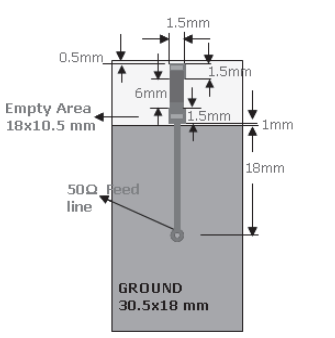
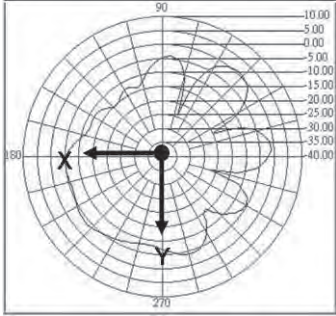
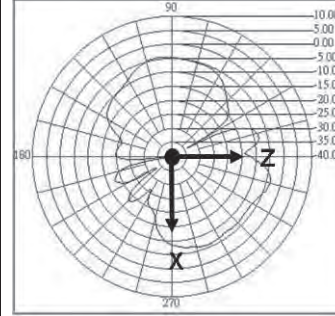
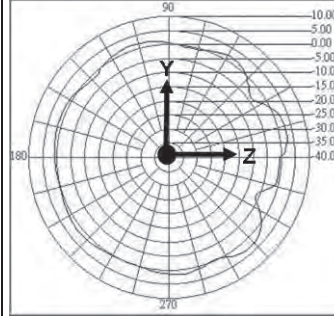
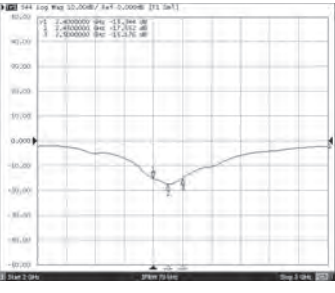
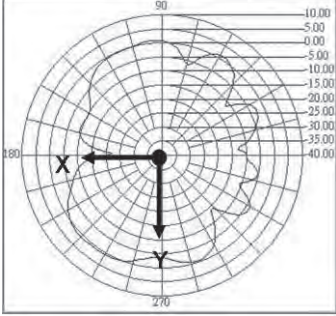
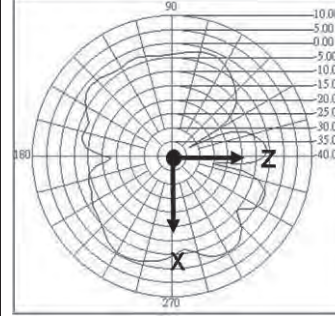
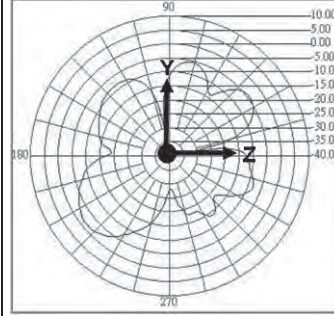
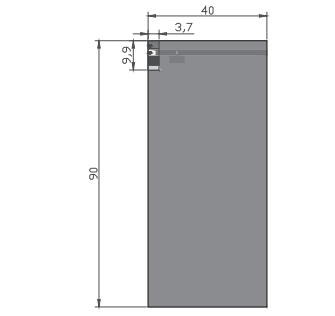
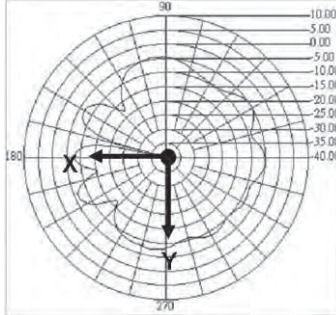
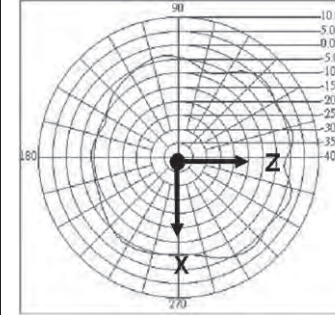
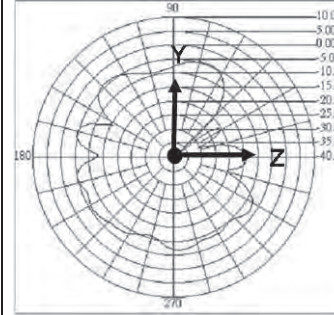
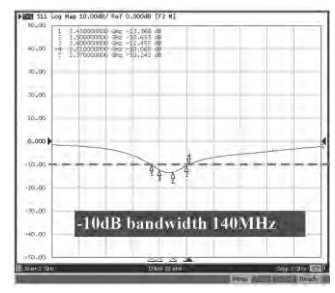
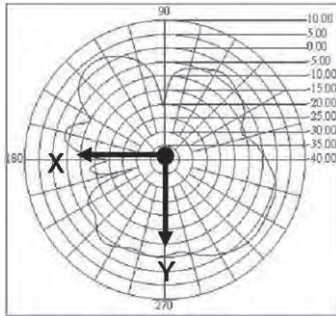
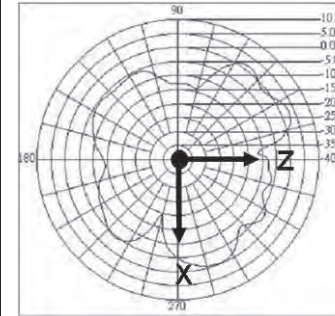
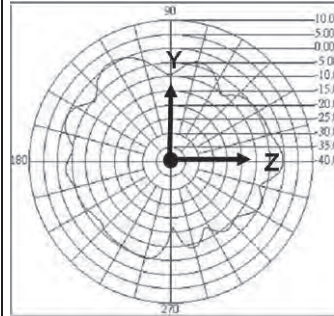

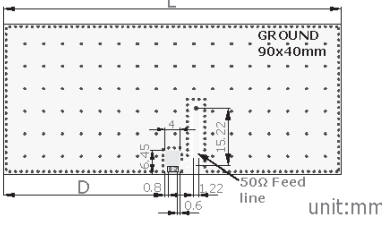
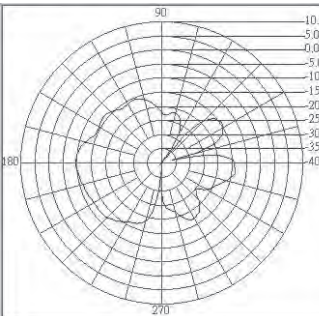
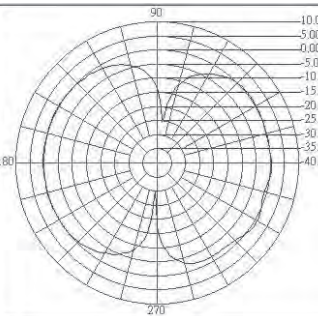
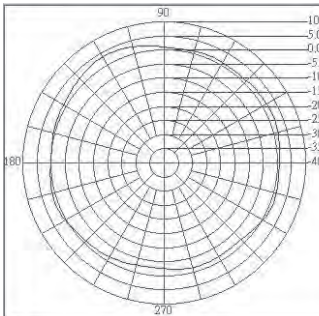
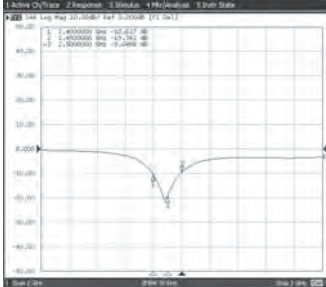
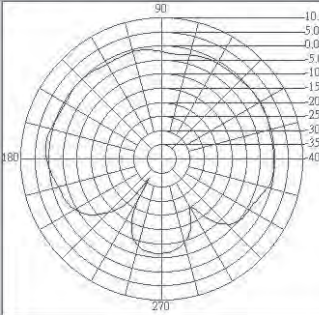
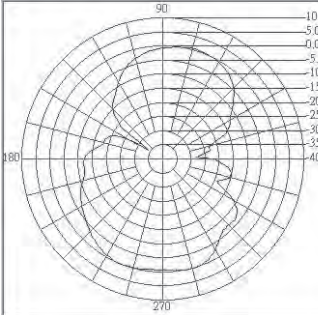
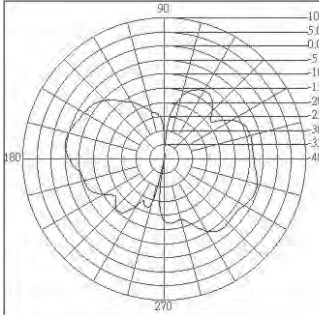
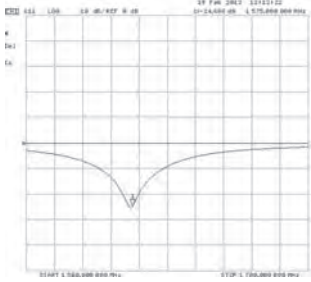
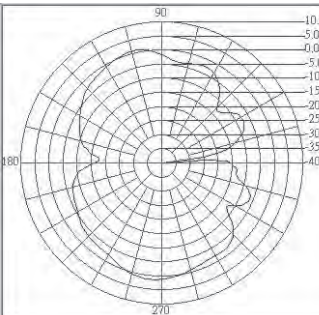
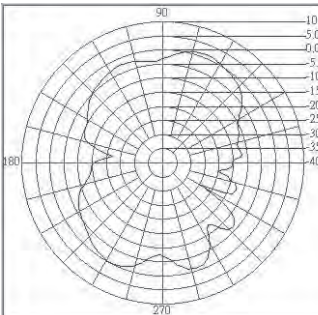
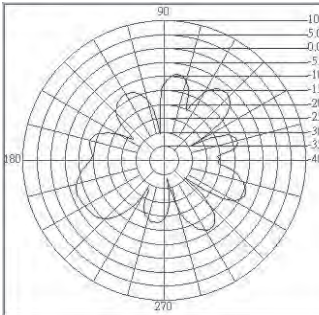
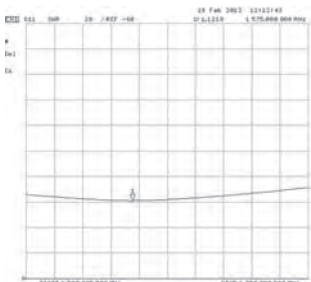
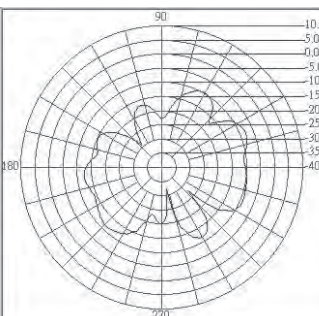
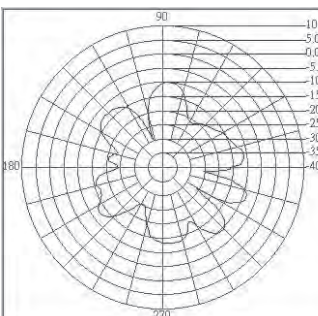
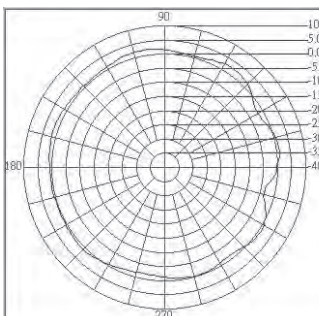
■ **TYPICAL ELECTRICAL CHARACTERISTICS**

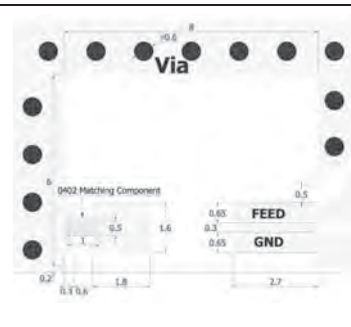
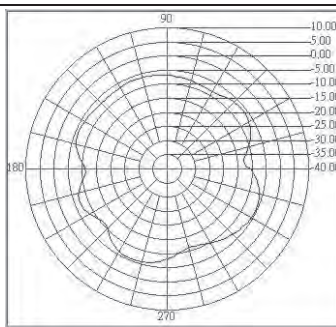
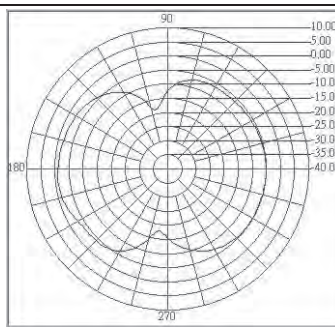
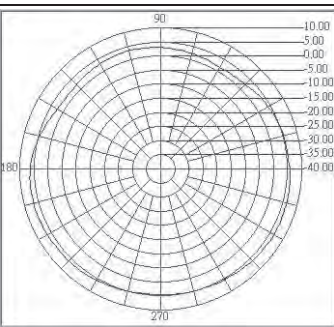
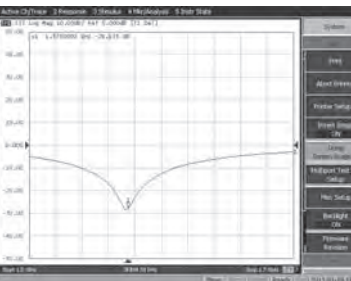
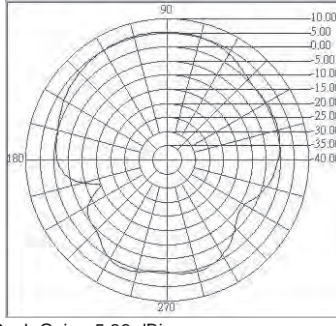
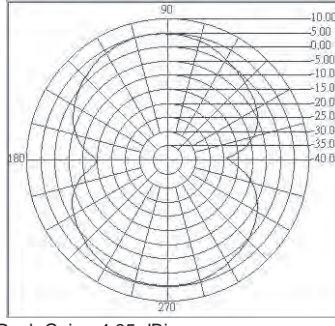
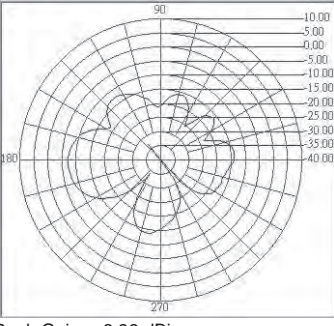
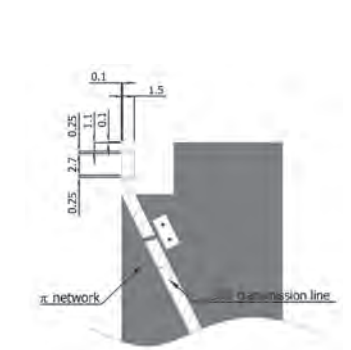
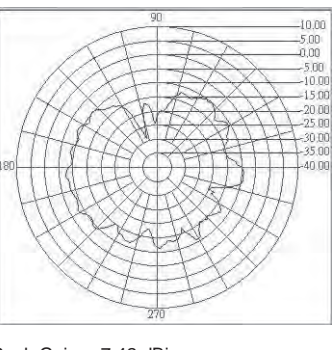
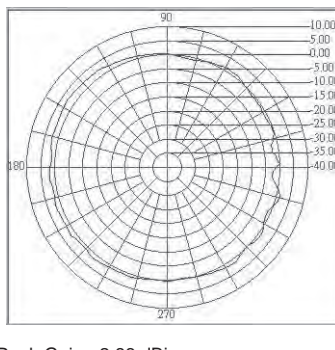
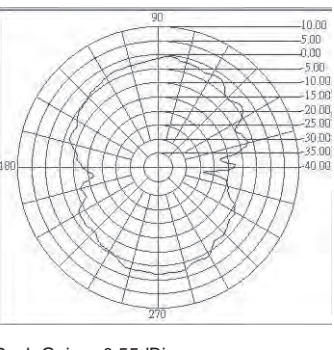
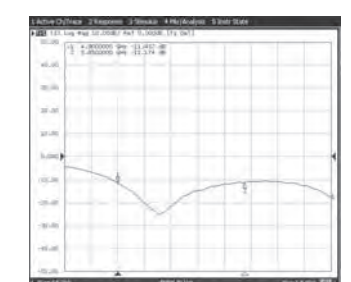
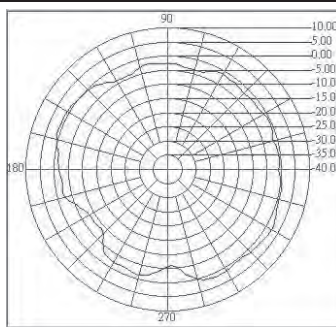
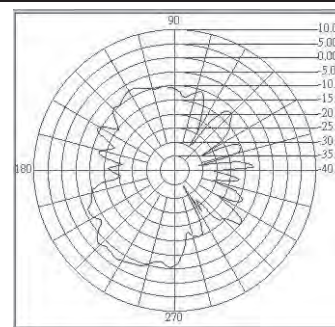
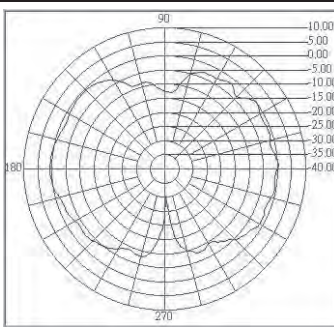
RFANT5220110A0T			
Test Board	X-Y Plane Vertical	X-Z Plane Vertical	Y-Z Plane Vertical
	<p>Peak Gain= -5.97dBi Average Gain=-3.12 dBi</p>	<p>Peak Gain= -5.97dBi Average Gain=-3.24 dBi</p>	<p>Peak Gain= 1.69dBi Average Gain=-3.22 dBi</p>
Return Loss (S11)	X-Y Plane Horizontal	X-Z Plane Horizontal	Y-Z Plane Horizontal
	<p>Peak Gain= 2.59dBi Average Gain=-9.24 dBi</p>	<p>Peak Gain= 2.66dBi Average Gain=-8.61 dBi</p>	<p>Peak Gain= -5.42dBi Average Gain=-8.98 dBi</p>
RGFAR1903041A1T			
Test Board	X-Y Plane Vertical	X-Z Plane Vertical	Y-Z Plane Vertical
	<p>Peak Gain= -7.42 dBi Average Gain= -10.48 dBi</p>	<p>Peak Gain= 1.95 dBi Average Gain= -0.81 dBi</p>	<p>Peak Gain= -0.26dBi Average Gain=-5 dBi</p>
Return Loss (S11)	X-Y Plane Horizontal	X-Z Plane Horizontal	Y-Z Plane Horizontal
	<p>Peak Gain= 2.0 dBi Average Gain= -2.31 dBi</p>	<p>Peak Gain= -2.65 dBi Average Gain= -8.4dBi</p>	<p>Peak Gain= 1.11dBi Average Gain = -4.37 dBi</p>

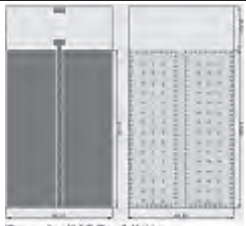
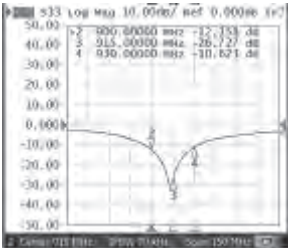
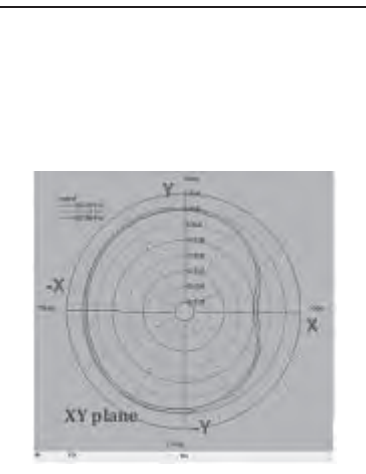
RFANT8010080A3T			
Test Board 	X-Y Plane Vertical  Peak Gain= 0.76 dBi Average Gain= -5.81dBi	X-Z Plane Vertical  Peak Gain= -3.76 dBi Average Gain= -8.72dBi	Y-Z Plane Vertical  Peak Gain = 3.03 dBi Average Gain = 0.71 dBi
Return Loss (S11) 	X-Y Plane Horizontal  Peak Gain= 1.37 dBi Average Gain= -2.67 dBi	X-Z Plane Horizontal  Peak Gain= -0.25 dBi Average Gain= -4.24 dBi	Y-Z Plane Horizontal  Peak Gain= -1.37 dBi Average Gain= -8.6 dBi
RGFAR9937380A3T			
Test Board 	X-Y Plane Vertical  Peak Gain= -4.48 dBi Average Gain= -8.02 dBi	X-Z Plane Vertical  Peak Gain= 2.49 dBi Average Gain= -2.47 dBi	Y-Z Plane Vertical  Peak Gain= -4.05dBi Average Gain= -8.03 dBi
Return Loss (S11) 	X-Y Plane Horizontal  Peak Gain= 3.19 dBi Average Gain= -2.65 dBi	X-Z Plane Horizontal  Peak Gain= 3.05 dBi Average Gain= -4.10dBi	Y-Z Plane Horizontal  Peak Gain = 0.95dBi Average Gain = -4.26 dBi

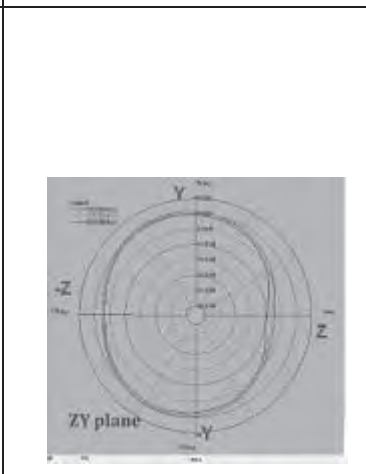
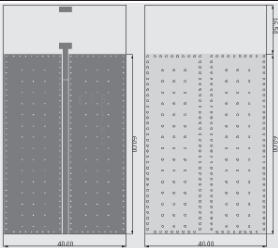
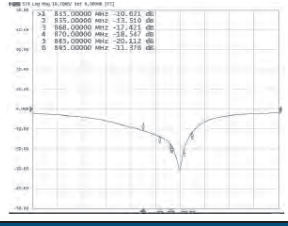
RFECA3216060A1T			
Test Board	X-Y Plane Vertical	X-Z Plane Vertical	Y-Z Plane Vertical
 <p>unit:mm</p>	 <p>Peak Gain = 3.37 dBi Average Gain = -0.65 dBi</p>	 <p>Peak Gain= 0.83 dBi Average Gain= -1.35 dBi</p>	 <p>Peak Gain= -9.59 dBi Average Gain= -15.40 dBi</p>
Return Loss (S11)	X-Y Plane Horizontal	X-Z Plane Horizontal	Y-Z Plane Horizontal
	 <p>Peak Gain= -4.62 dBi Average Gain=-10.42 dBi</p>	 <p>Peak Gain= 0.51 dBi Average Gain= -4.07 dBi</p>	 <p>Peak Gain= 1.39 dBi Average Gain= -2.07 dBi</p>
RFECA1003011E0T			
Antenna S11 on Test Board	X-Y Plane Vertical	X-Z Plane Vertical	Y-Z Plane Vertical
	 <p>Peak Gain = 3.12dBi Average Gain = -3.99 dBi</p>	 <p>Peak Gain= 1.97dBi Average Gain= -1.44 dBi</p>	 <p>Peak Gain = 3.32dBi Average Gain = 1.02 dBi</p>
Antenna VSWR on Test Board	X-Y Plane Horizontal	X-Z Plane Horizontal	Y-Z Plane Horizontal
	 <p>Peak Gain = +0.48dBi Average Gain = -4.59dBi</p>	 <p>Peak Gain = +4.99dBi Average Gain = -1.31dBi</p>	 <p>Peak Gain = +3.02dBi Average Gain = -0.85dBi</p>

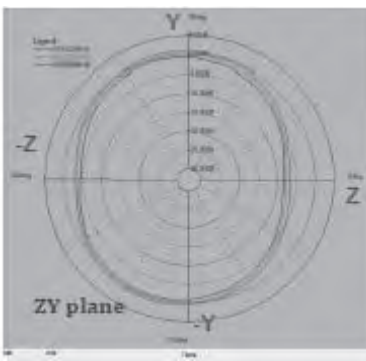
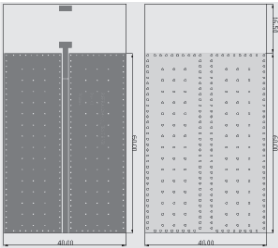
RFECA3216060E1T			
Land Pattern	X-Y Plane Vertical	X-Z Plane Vertical	Y-Z Plane Vertical
	 <p>Peak Gain= -5.51 dBi Average Gain= -7.48 dBi</p>	 <p>Peak Gain= -0.85 dBi Average Gain= -5.22 dBi</p>	 <p>Peak Gain= 6.74 dBi Average Gain = 4.81 dBi</p>
Return Loss (S11)	X-Y Plane Horizontal	X-Z Plane Horizontal	Y-Z Plane Horizontal
	 <p>Peak Gain= 5.36 dBi Average Gain= 1.25 dBi</p>	 <p>Peak Gain= 4.85 dBi Average Gain= 1.21 dBi</p>	 <p>Peak Gain= -6.99 dBi Average Gain= -14.30 dBi</p>
RFECA3216060K1T			
Land Pattern	X-Y Plane Vertical	X-Z Plane Vertical	Y-Z Plane Vertical
	 <p>Peak Gain= -7.42 dBi Average Gain= -11.78 dBi</p>	 <p>Peak Gain= 2.86 dBi Average Gain= 0.86 dBi</p>	 <p>Peak Gain= -0.55 dBi Average Gain= -4.9 dBi</p>
Return Loss (S11)	X-Y Plane Horizontal	X-Z Plane Horizontal	Y-Z Plane Horizontal
	 <p>Peak Gain= 2.3 dBi Average Gain= -1.1 dBi</p>	 <p>Peak Gain= -2.49 dBi Average Gain= -9.61 dBi</p>	 <p>Peak Gain = 0.73 dBi Average Gain = -2.86 dBi</p>

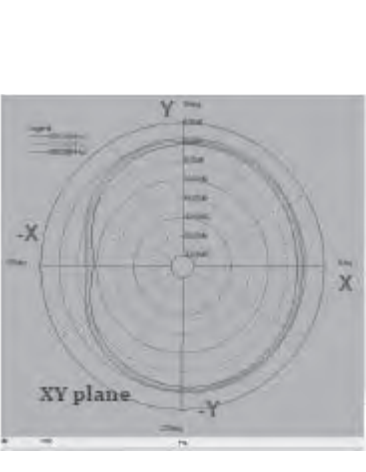
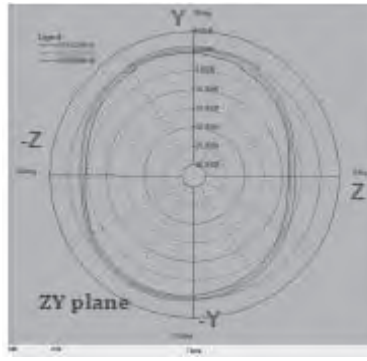
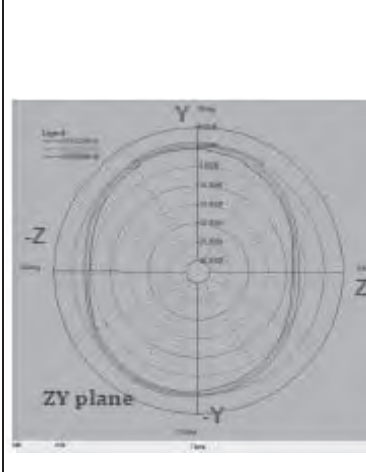
RGFRA1204011DCT			
Test Board	X-Y Plane	X-Z Plane	Y-Z Plane
 <p>Return Loss (S11)</p> 	 <p>Peak Gain= -0.82 dBi Average Gain= -1.11 dBi</p>	 <p>Peak Gain= 0.56 dBi Average Gain= -3.41 dBi</p>	 <p>Peak Gain= 0.94dBi Average Gain=-1.48 dBi</p>
RGFRA1204011DET			
Test Board	X-Y Plane	X-Z Plane	Y-Z Plane
 <p>Return Loss (S11)</p> 	 <p>Peak Gain= -0.85 dBi Average Gain= -0.74 dBi</p>	 <p>Peak Gain= -1.06 dBi Average Gain= -3.01 dBi</p>	 <p>Peak Gain= -0.82dBi Average Gain=-1.29 dBi</p>
RGFRA1204011DET			
Test Board	X-Y Plane	X-Z Plane	Y-Z Plane
 <p>Return Loss (S11)</p> 	 <p>Peak Gain= -0.85 dBi Average Gain= -0.74 dBi</p>	 <p>Peak Gain= -1.06 dBi Average Gain= -3.01 dBi</p>	 <p>Peak Gain= -0.82dBi Average Gain=-1.29 dBi</p>

- For more information, please contact with local sales representative
- All specifications are subject to change without notice

HIGH FREQUENCY MULTILAYER BAND PASS FILTER

■ **STRUCTURE AND PIN ASSOCIATED**

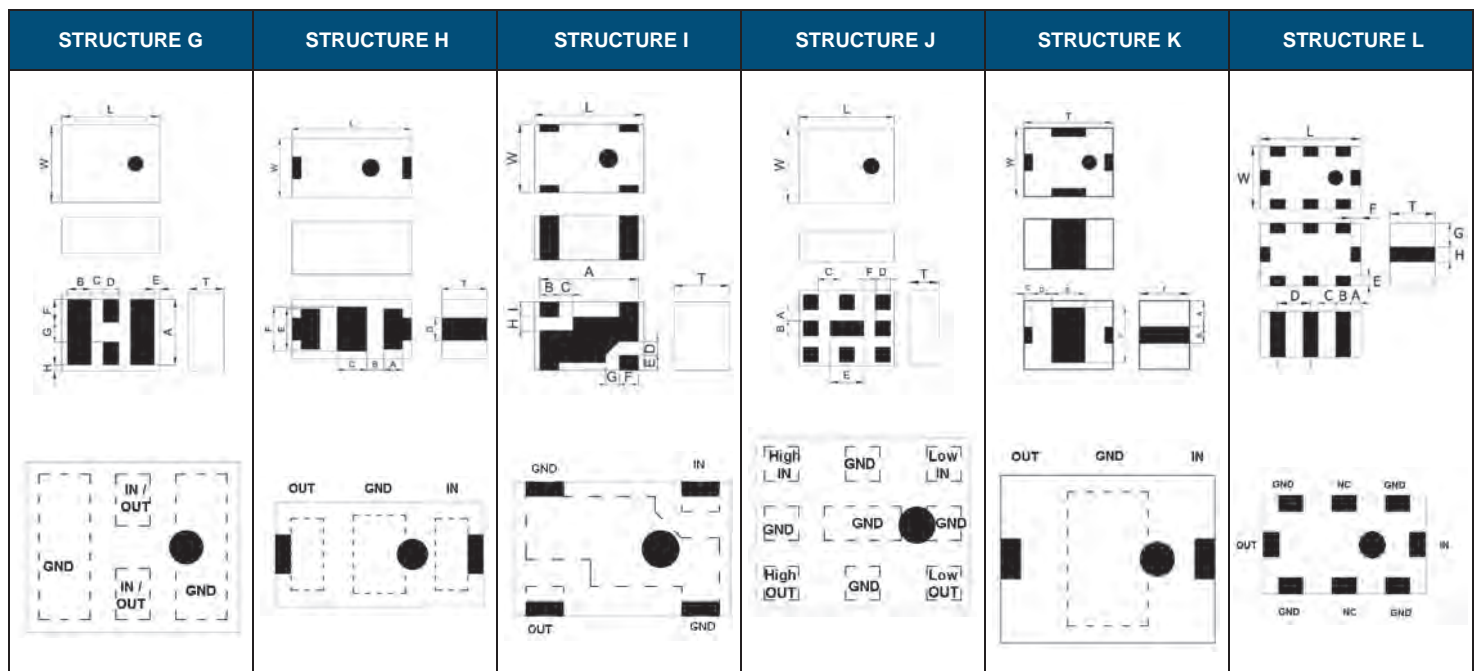
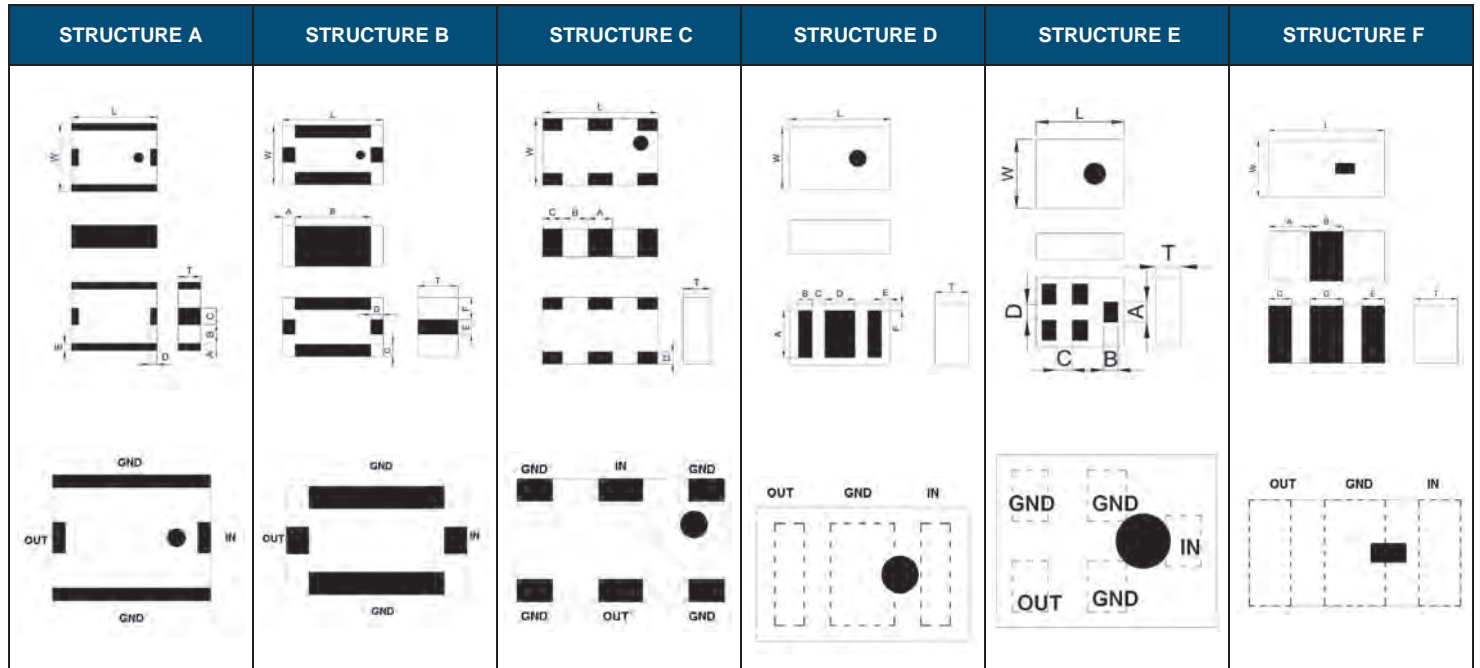

■ **STRUCTURE AND DIMENSION**

Unit: mm

Structure\ Dimension	L	W	T	A	B	C	D	E	F	G	H	I	
A	2.50±0.20	2.00±0.20	0.70±0.10	0.20±0.20	0.55±0.20	0.50±0.20	0.25±0.20	0.20±0.20	-	-	-	-	
			0.90±0.10	0.20±0.20	0.55±0.20	0.50±0.20	0.20±0.20	0.20±0.20	-	-	-	-	
			1.00±0.10	0.20±0.20	0.55±0.20	0.50±0.20	0.25±0.20	0.20±0.20	-	-	-	-	
			1.05±0.10	0.25±0.20	0.50±0.20	0.50±0.20	0.25±0.20	0.25±0.20	-	-	-	-	
			1.20±0.10	0.25±0.20	0.50±0.20	0.50±0.20	0.25±0.20	0.25±0.20	-	-	-	-	
	2.05±0.20	0.70±0.20	0.25±0.20	0.50±0.20	0.50±0.20	0.25±0.20	0.25±0.20	-	-	-	-		
3.20±0.20	2.50±0.10	1.50±0.10	0.20±0.20	0.75±0.20	0.60±0.20	0.20±0.15	0.40±0.20	-	-	-	-		
B	1.00±0.10	0.50±0.10	0.40±0.10	0.35±0.10	0.30±0.10	0.15±0.10	0.15±0.10	0.30±0.10	-	-	-	-	
	1.60±0.15	0.80±0.15	0.50±0.10	0.45±0.15	0.70±0.15	0.20±0.15	0.20±0.15	0.30±0.15	0.25±0.15	-	-	-	
			0.60±0.10	0.45±0.15	0.70±0.15	0.20±0.15	0.20±0.15	0.30±0.15	0.25±0.15	-	-	-	
			0.70±0.10	0.40±0.15	0.80±0.15	0.20±0.10	0.20±0.10	0.30±0.15	0.25±0.15	-	-	-	
			0.70±0.10	0.45±0.15	0.70±0.15	0.20±0.10	0.20±0.10	0.30±0.15	0.25±0.15	-	-	-	
	2.00±.15	1.20±0.15	0.90±0.10	0.50±0.10	0.40±0.15	0.80±0.15	0.20±0.10	0.20±0.10	0.30±0.15	0.45±0.15	-	-	-
				0.20±0.15	1.60±0.15	0.20±0.15	0.20±0.15	0.40±0.15	0.40±0.15	-	-	-	
			0.20±0.15	1.60±0.15	0.25±0.15	0.25±0.15	0.30±0.15	0.45±0.15	-	-	-		
			0.45±0.15	1.10±0.15	0.25±0.15	0.25±0.15	0.30±0.15	0.45±0.15	-	-	-		
			0.50±0.15	1.00±0.15	0.20±0.15	0.20±0.15	0.30±0.15	0.45±0.15	-	-	-		
		1.25±0.15	0.60±0.10	0.50±0.15	1.00±0.15	0.25±0.15	0.25±0.15	0.30±0.15	0.475±0.15	-	-	-	
			0.80±0.10	0.50±0.15	1.00±0.15	0.25±0.15	0.25±0.15	0.30±0.15	0.475±0.15	-	-	-	
			0.90±0.10	0.50±0.15	1.00±0.15	0.25±0.15	0.25±0.15	0.30±0.15	0.475±0.15	-	-	-	
			0.95±0.10	0.35±0.15	1.30±0.15	0.20±0.15	0.20±0.15	0.30±0.15	0.475±0.15	-	-	-	
0.35±0.15				1.30±0.15	0.25±0.15	0.25±0.15	0.30±0.15	0.475±0.15	-	-	-		
0.50±0.15	1.00±0.15	0.25±0.15	0.25±0.15	0.30±0.15	0.475±0.15	-	-	-					
C	2.00±.15	1.20±0.20	0.55±0.10	0.40±0.20	0.40±0.20	0.40±0.20	0.20±0.10	-	-	-	-	-	
			0.60±0.10	0.40±0.20	0.40±0.20	0.40±0.20	0.20±0.10	-	-	-	-	-	
			0.80±0.10	0.40±0.20	0.40±0.20	0.40±0.20	0.20±0.10	-	-	-	-	-	
D	1.60±0.15	0.80±0.15	0.60±0.10	0.55±0.10	0.25±0.10	0.23±0.10	0.40±0.10	0.12±0.10	0.125±0.10	-	-	-	
	2.00±.15	1.25±0.10	0.45±0.10	0.95±0.10	0.275±0.20	0.25±0.10	0.60±0.10	0.175±0.10	0.15±0.10	-	-	-	
			0.70 max	0.95±0.10	0.275±0.10	0.25±0.10	0.60±0.10	0.175±0.10	0.15±0.10	-	-	-	
0.80±0.10	0.95±0.10	0.275±0.10	0.25±0.10	0.60±0.10	0.175±0.10	0.15±0.10	-	-	-	-			
E	1.10±0.10	0.90±0.10	0.60±0.10	0.25±0.10	0.18±0.10	0.205±0.10	0.25±0.10	-	-	-	-	-	
	1.40±0.15	1.10±0.10	0.60±0.10	0.325±0.10	0.25±0.10	0.25±0.10	0.25±0.10	-	-	-	-	-	
	1.40±0.15	1.10±0.15	0.70±0.10	0.325±0.10	0.25±0.10	0.25±0.10	0.25±0.10	-	-	-	-	-	
	2.00±0.20	1.25±0.20	1.00 max.	0.325±0.10	0.25±0.10	0.25±0.10	0.25±0.10	-	-	-	-	-	
F	1.60±0.15	0.80±0.15	0.40±0.10	0.55±0.15	0.50±0.15	0.35±0.15	0.50±0.15	0.20±0.15	-	-	-	-	
			0.60±0.10	0.55±0.15	0.50±0.15	0.35±0.15	0.50±0.15	0.20±0.15	-	-	-	-	
G	1.60±0.10	0.80±0.10	0.70 max.	0.55±0.10	0.25±0.10	0.23±0.10	0.40±0.10	0.12±0.10	0.195±0.10	0.21±0.10	0.125±0.10	-	
	2.00±0.15	1.25±0.10	0.80±0.10	0.95±0.10	0.40±0.10	0.30±0.10	0.30±0.10	0.15±0.10	0.30±0.10	0.35±0.10	0.15±0.10	-	
			0.90±0.10	0.95±0.10	0.40±0.10	0.30±0.10	0.30±0.10	0.15±0.10	0.30±0.10	0.35±0.10	0.15±0.10	-	
2.50±0.20	2.00±0.20	0.90±0.10	1.70±0.20	0.60±0.20	0.30±0.20	0.40±0.20	0.15±0.10	0.60±0.10	0.50±0.10	0.15±0.10	-		
H	1.60±0.15	0.80±0.10	0.60 max.	0.25±0.10	0.23±0.05	0.40±0.10	0.30±0.10	0.55±0.10	0.60±0.10	-	-	-	
I	2.00±0.15	1.25±0.10	1.00 max.	1.80±0.10	0.35±0.10	0.25±0.10	0.25±0.10	0.275±0.10	0.35±0.10	0.25±0.10	0.25±0.10	0.275±0.10	
J	2.50±0.15	2.00±0.15	0.90±0.10	0.30±0.10	0.40±0.10	0.55±0.10	0.40±0.10	0.90±0.10	0.30±0.10	-	-	-	
K	2.00±0.15	1.25±0.15	1.05±0.15	0.475±0.15	0.30±0.15	0.20±0.15	0.50±0.15	0.60±0.15	0.95±0.15	-	-	-	
	3.20±0.20	2.50±0.20	1.80±0.20	0.95±0.20	0.60±0.20	0.30±0.15	0.70±0.15	1.20±0.15	2.00±0.15	-	-	-	
L	2.00±0.15	1.25±0.10	1.05 max.	0.20±0.10	0.35±0.10	0.30±0.10	0.65±0.10	0.20±0.10	0.20±0.10	0.475±0.10	0.30±0.10	-	

■ ELECTRICAL SPECIFICATION

2.4GHz BAND WORKING FREQUENCY

Part Number	Frequency Range(GHz)	Insertion Loss (dB)	Attenuation (dB min.)	VSWR (max.)	Impedance (Ω)	Size(mm)	STRUCTURE
RBBPF1005040A1T	2.4-2.5	2.5	25(824-960MHz) 20(1710-1910MHz) 20(4800-5000MHz) 15(7200-7500MHz)	2.0	50	1.00x0.50x0.40	B
RFBPF1005040A3T	2.4-2.5	1.5max.(25°C) 1.7max.(-40~+85°C)	13(824-915MHz) 5(1545-1605MHz) 34(4800-5000MHz) 27(7200-7500MHz)	2.1	50	1.00x0.50x0.40	B
RFBPF1109060A0T	2.4-2.5	1.8	35(824-960MHz) 38(1545-1605MHz) 20(1710-1990MHz) 8(2110-2170MHz) 35(3600MHz) 35(4800-5000MHz) 35(7200-7500MHz)	2.0	50	1.10x 0.90x0.60	E
RFBPF1411060A1T	2.4-2.5	1.8max.(25°C) 2.1max.(-40~+85°C)	40(824-960MHz) 40(1545-1605MHz) 20(1710-1990MHz) 8(2110-2170MHz) 35(3600MHz) 35(4800-5000MHz) 35(7200-7500MHz)	2.0	50	1.40x1.10x0.60	E
RFBPF1411060A2T	2.4-2.5	1.5	30(500-960MHz) 25(1500-1650MHz) 19(3200-3300MHz) 40(4800-5000MHz) 30(7200-7500MHz)	2.0	50	1.40x1.10x0.60	E
RBBPF1411060A3T	2.4-2.5	1.1	20(50-960MHz) 10(1710-1990MHz) 9(3600MHz) 22(4800-7200MHz)	2.0	50	1.40x1.10x0.60	E
RBBPF1411060A8T	2.4-2.5	1.0max.(25°C) 1.2max.(-40~+85°C)	15(50-960MHz) 10(1710-1990MHz) 15(3600MHz) 25(4800-7200MHz)	2.0	50	1.40x1.10x0.60	E
RFBPF1608060AA7M1U	2.4-2.5	0.95max.(25°C) 1.25max.(-40~+85°C)	20(500-960MHz) 23(3200MHz) 30(4800-5000MHz) 32(7200-7500MHz)	2.0	50	1.60x0.80x0.60	H
RFBPF1608060ADT	2.4-2.5	1.8max.(25°C) 2.1max.(-40~+85°C)	25(800-1000MHz) 22.5(1200-1300MHz) 5.5(2000MHz) 10.5(3000MHz) 23.5(3600-3800MHz) 35(4800-5000MHz) 35(7200-7500MHz)	2.0	50	1.60x0.80x0.60	B
RFBPF1608060AET	2.4-2.5	1.7max.(25°C) 2.0max.(-40~+85°C)	25(880MHz) 20(3200MHz) 35(4800-5000MHz) 25(7200-7500MHz)	2.0	50	1.60x0.80x0.60	F
RFBPF1608070AFT	2.4-2.5	2.4max.(25°C) 2.7max.(-40~+85°C)	24.5(880-960MHz) 20(1710-1990MHz) 8.5(2170MHz) 15(4800-5000MHz) 20(7200-7500MHz)	2.0	50	1.60x0.80x0.70	B
RFBPF1608070AWT	2.4-2.5	2.0max.(25°C) 2.2max.(-40~+85°C)	30 (960MHz) 25(1910MHz) 20(1990MHz) 25(4800MHz) 15(7200MHz)	2.0	50	1.60x0.80x0.70	B
RFBPF1608050A0T	2.4-2.5	2.0max.(25°C) 2.2max.(-40~+85°C)	20(960MHz) 20(1910MHz) 15(1990MHz) 18(4800MHz) 25(7200MHz)	2.0	50	1.60x0.80x0.50	B
RFBPF1608060A1T	2.4-2.5	2.8	25(695-800MHz) 20(1910MHz) 35(3200MHz) 20(4800-5000MHz) 20(7200-7500MHz)	2.0	50	1.60x0.80x0.60	B
RFBPF1608060A7T	2.4-2.5	3.0	25(695-800MHz) 20(1910MHz) 35(3200MHz) 20(4800-5000MHz) 20(7200-7500MHz)	2.0	50	1.60x0.80x0.60	B

2.4GHz BAND WORKING FREQUENCY

Part Number	Frequency Range(GHz)	Insertion Loss (dB)	Attenuation (dB min.)	VSWR (max.)	Impedance (Ω)	Size(mm)	STRUCTURE
RFBPF1608070A3T	2.4~2.5	1.8max.(25°C) 2.1max.(-40~+85°C)	27(800-900MHz) 25(4800-5000MHz) 30(7200-7500MHz)	2.0	50	1.60x0.80x0.70	B
RFBPF2012080AM0T62	2.4~2.5	1.8max.(25°C) 2.0max.(-40~+85°C)	30(860-960MHz) 30(1545-1605MHz) 35(1710-1990MHz) 30(2170MHz) 30(4800-5000MHz)	2.0	50	2.00x1.20x0.80	D
RFBPF2008A38T	2.4~2.5	1.80max.(25°C) 2.00max.(-40~+85°C)	30(860-960MHz) 30(1545-1605MHz) 35(1710-1990MHz) 30(2170MHz) 30(4800-5000MHz)	2.0	50	2.00x1.25x0.80	G
RFBPF2012090AS1T35	2.4~2.5	0.9max.(25°C) 1.1max.(-40~+85°C)	28(824-960MHz) 30(1570-1580MHz) 15(1710-1910MHz) 9.5(1910-1990MHz) 25(4800-5000MHz) 25(7200-7500MHz)	2.0	50	2.00x1.25x0.90	G
RFBPF2012060AAT	2.4~2.5	1.5max.(25°C) 1.8max.(-40~+85°C)	30(880-960MHz) 25(1710-1910MHz) 25(4800-5000MHz) 30(7200-7500MHz)	2.0	50	2.00x1.20x0.60	C
RFBPF2012040ABT	2.4~2.5	2.5	30(824-849MHz) 30(880-915MHz) 30(1545-1605MHz) 30(1565-1585MHz) 35(1710-1785MHz) 40(1850-1910MHz) 32(1920-1980MHz) 7(3168-4752MHz) 11(3300-3800MHz) 35(4800-4967MHz) 26(5150-6000MHz) 23(7200-7450MHz)	2.0	50	2.00x1.20x0.40	D
RFBPF2012050ACT	2.4~2.5	2.5	35(824-960MHz) 38(1710-1910MHz) 25(4880-5000MHz) 20(7200-7500MHz)	2.0	50	2.00x1.20x0.55	C
RFBPF2012080ADT	2.4~2.5	1.5max.(25°C) 1.7max.(-40~+85°C)	30(860-960MHz) 30(1545-1605MHz) 30(1710-1990MHz) 30(2170MHz) 30(4800-5000MHz)	2.0	50	2.00x1.25x0.80	D
RFBPF2008A40T	2.4~2.5	1.8max.(25°C) 2.0max.(-40~+85°C)	30(824-915MHz) 30(1545-1605MHz) 35(1710-1990MHz) 30(2170MHz) 30(4800-4967MHz) 25(5150-6000MHz) 20(7200-7450.5MHz)	2.0	50	2.00x1.25x0.80	D
RFBPF2008A39T	2.4~2.5	1.8max.(25°C) 2.0max.(-40~+85°C)	35(824-960MHz) 28(1540-1605MHz) 30(1710-1990MHz) 30(2170MHz) 6(3200MHz) 30(4800-4967MHz) 20(5150-6000MHz) 18(7200-7450MHz)	2.0	50	2.00x1.25x0.80	D
RFBPF2012040AHT	2.4~2.5	2.5	25(746-764MHz) 30(824-849MHz) 26(869-960MHz) 28(1570-1580MHz) 28(1710-1785MHz) 30(1850-1910MHz) 30(1930-1990MHz) 30(2110-2170MHz) 15(3300-3800MHz) 35(4800-5000MHz) 20(7200-7450.5MHz)	2.0	50	2.00x1.25x0.45	D
RBBPF2012050AHT	2.4~2.5	2.5max.(typ.2.2)	25(746-764MHz) 30(824-849MHz) 26(869-960MHz) 28(1570-1580MHz) 28(1710-1785MHz) 30(1850-1910MHz) 30(1930-1990MHz) 25(2110-2170MHz) 15(3300-3800MHz) 35(4800-5000MHz)	2.0	50	2.00x1.25x0.45	D

2.4GHz BAND WORKING FREQUENCY

Part Number	Frequency Range(GHz)	Insertion Loss (dB)	Attenuation (dB min.)	VSWR (max.)	Impedance (Ω)	Size(mm)	STRUCTURE
RFBPF2012090ALT	2.4-2.5	1.0max.(25°C) 1.2max.(-40~+85°C)	28(824-960MHz) 28(1570-1580MHz) 23(1710-1910MHz) 17(1920-1990MHz) 25(4800-5000MHz)	2.0	50	2.00x1.25x0.90	G
RFBPF2012090AMT	2.4-2.5	2.6	40(880-960MHz) 38(1710-1990MHz) 16(2170MHz) 30(4800-5000MHz) 30(7200-7500MHz)	2.0	50	2.00x1.20x0.90	B
RFBPF2012100ANT	2.4-2.5	2.3max.(25°C) 2.6max.(-40~+85°C)	40(699-960MHz) 40(1428-1448MHz) 40(1476-1607MHz) 40(1710-1785MHz) 33(1805-1880MHz) 30(1880-1915MHz) 30(1920-1990MHz) 22(2110-2170MHz) 25(4800-5000MHz) 35(7200-7500MHz)	2.0	50	2.00x1.20x1.00	I
RFBPF2012090AQT	2.4-2.5	1.2	20(1600MHz) 25(3200MHz) 20(4800-5000MHz)	2.0	50	2.00x1.20x0.90	B
RFBPF2012090ART	2.4-2.5	1.0	20(1600MHz) 25(3200MHz)	2.0	50	2.00x1.20x0.90	B
RFBPF2012100AVT	2.4-2.5	1.5max.(25°C) 1.7max.(-40~+85°C)	40(699-960MHz) 40(1428-1448MHz) 40(1476-1607MHz) 40(1710-1785MHz) 33(1805-1880MHz) 30(1880-1915MHz) 30(1920-1990MHz) 25(4800-5000MHz) 30(7200-7500MHz)	2.0	50	2.00x1.20x1.00	I
RBBPF2010A108Q1C	2.4-2.5	1.3max.(25°C) 1.5max.(-40~+85°C)	38(50-960MHz) 17(1710-1910MHz) 5(3200MHz) 30(4800-5000MHz) 25(7200-7500MHz)	2.0	50	2.00x1.20x0.90	E
RFBPF2009A12T	2.4-2.5	1.0max.(25°C) 1.2max.(-40~+85°C)	28(824-960MHz) 28(1570-1580MHz) 23(1710-1910MHz) 17(1920-1990MHz) 4(2100-2170MHz) 25(4800-5000MHz) 25(7200-7500MHz)	2.0	50	2.00x1.25x0.90	G
RBBPF2010A16T	2.4-2.5	1.3max.(25°C) 1.5max.(-40~+85°C)	38(50-960MHz) 17(1710-1990MHz) 20(3200MHz) 30(4800-5000MHz) 25(7200-7500MHz)	2.0	50	2.00x1.25x1.00	E
RFBPF2009A25T	2.4-2.5	1.7max.(25°C) 1.9max.(-40~+85°C)	30(900MHz) 20(1850MHz) 30(4800MHz)	2.0	50	2.00x1.20x0.90	B
RFBPF2009A26T	2.4-2.5	1.4max.(25°C) 1.6max.(-40~+85°C)	30(824-960MHz) 30(1710-1910MHz) 20(1920-1990MHz) 6(2110-2170MHz) 20(4800-5000MHz)	2.0	50	2.00x1.20x0.90	B
RFBPF2012040A3T	2.4-2.5	2.0max.(25°C) 2.2max.(-40~+85°C)	25(746-764MHz) 30(824-849MHz) 26(869-960MHz) 28(1570-1580MHz) 28(1710-1785MHz) 30(1850-1910MHz) 30(1930-1990MHz) 25(2110-2170MHz) 15(3300-3800MHz) 35(4800-5000MHz) 20(7200-7450.5MHz)	2.0	50	2.00x1.25x0.45	D

2.4GHz BAND WORKING FREQUENCY

Part Number	Frequency Range(GHz)	Insertion Loss (dB)	Attenuation (dB min.)	VSWR (max.)	Impedance (Ω)	Size(mm)	STRUCTURE
RFBPF2012080A6T	2.4-2.5	3.5	30(880-960MHz) 30(1710-1990MHz) 20(2110-2170MHz) 30(4800-5000MHz) 30(7200-7500MHz)	2.0	50	2.00x1.20x0.80	C
RFBPF2012100A6T	2.4-2.5	1.0max.(25°C) 1.2max.(-40~+85°C)	21(902-928MHz) 26(4800-5000MHz) 34(7200-7500MHz) 29(9600-10000MHz)	2.0	50	2.00x1.20x1.00	L
RFBPF2012080A7T	2.4-2.5	2.8 (typ.2.5)	40(DC-1600MHz) 35(1710MHz) 25(1900MHz) 12(2100MHz) 8(2170MHz) 30(3100MHz) 40(4800-5000MHz) 20(7200-7500MHz)	2.0	50	2.00x1.20x0.80	B
RFBPF2012060A9T	2.4-2.5	2.8	30(960MHz) 30(1600MHz) 20(1990MHz) 35(3200MHz) 40(4800MHz) 25(7200MHz)	2.0	50	2.00x1.20x0.60	B
RFBPF2520090ACT	2.4-2.5	2.1max.(25°C) 2.3max.(-40~+85°C)	43(806-960MHz) 43(1570-1580MHz) 43(1710-1990MHz) 20(2110-2170MHz) 30(4800-5000MHz) 25(7200-7500MHz)	2.0	50	2.50x2.00x0.90	G
RFBPF2520070AMT	2.4-2.5	2.0max.(25°C) 2.2max.(-40~+85°C)	45(824-960MHz) 45(1570-1580MHz) 45(1710-1785MHz) 40(1805-1850MHz) 35(1850-1910MHz) 35(1920-1990MHz) 25(2110-2170MHz) 5(2750-3000MHz) 15(3000-4800MHz) 30(4800-5000MHz) 30(5150-5850MHz) 20(7200-7500MHz)	2.0	50	2.50x2.00x0.70	A
RFBPF2520080AUT	2.4-2.5	2.2	30(900MHz) 30(1850MHz) 33(2170MHz) 35(4800MHz) 25(7200MHz)	2.0	50	2.50x2.00x0.70	A
RFBPF2520120A1T	2.4-2.5	1.7	30(900MHz) 30(1850MHz) 20(2100MHz) 40(4800MHz) 25(7200MHz)	2.0	50	2.50x2.00x1.20	A
RFBPF2520120A2T	2.4-2.5	2.1	30(900MHz) 30(1850MHz) 30(4800MHz)	2.0	50	2.50x2.00x1.20	A
RFBPF2520120A3T	2.4-2.5	≤1.2(25°C)	30(900MHz) 30(1850MHz) 25(4800MHz)	2.0	50	2.50x2.00x1.20	A
RFBPF2520120A4T	2.4-2.5	≤1.7(25°C)	30(900MHz) 30(1850MHz) 25(4800MHz)	2.0	50	2.50x2.00x1.20	A
RFBPF2520100A6T	2.4-2.5	1.4	35(1900/4800 MHz)	2.0	50	2.50x2.00x1.00	A

5GHZ BAND WORKING FREQUENCY

Part Number	Frequency Range(GHz)	Insertion Loss (dB)	Attenuation (dB min.)	VSWR (max.)	Impedance (Ω)	Size(mm)	STRUCTURE
RFBPF1608060K2T	4.9-5.84	1.5max.(25°C) 1.7max.(-40~+85°C)	33(100-2170MHz) 29(2170-2500MHz) 32(9800-12000MHz)	2.0	50	1.60x0.80x0.70	B
RFBPF1608060K68Q1C	4.9-5.9	1.3max.(25°C) 1.5max.(-40~+85°C)	38(30-2700MHz) 16(3453-3547MHz) 33(3667-3883MHz) 9(6900-7093MHz) 32(7333-7750MHz) 40(10600-11650MHz) 18(15540-17760MHz)	2.0	50	1.60x0.80x0.60	D
RFBPF1608060K78Q1C	5.15-5.95	0.8max.(25°C) 1.0max.(-40~+85°C)	40(30-2700MHz) 45(3400-3800MHz) 20(7250-7800MHz) 20(10300-11700MHz)	1.5	50	1.60x0.80x0.60	D
RFBPF1608060K88Q1C	5.15-5.95	0.7max.(25°C) 0.85max.(-40~+85°C)	35(30-2700MHz) 30(3400-3800MHz) 12(7250-7800MHz) 20(10300-11700MHz)	1.5	50	1.60x0.80x0.60	D
RFBPF1608060KG8D1T	5.15-5.95	0.8	40(30-2700MHz) 45(3400-3800MHz) 20(6900MHz) 20(7250-7800MHz) 20(10300-11700MHz)	1.67	50	1.60x0.80x0.60	D
RFBPF1606K12T	5.15-5.925	1.1max.(25°C) 1.3max.(-40~+85°C)	38(10-2700MHz) 20(2700-3550MHz) 15(3550-4000MHz) 3(4000-4500MHz) 5(4400MHz) 3(6500-7000MHz) 11(7000-7400MHz) 13(7400-9750MHz) 30(9750-10300MHz) 27(10300-12750MHz) 10(15540-17775MHz)	2.0	50	1.60x0.80x0.60	D
RFBPF2012100KST	4.9-5.9	1.5(4.90GHz) 1.5(5.25GHz) 1.5(5.85GHz)	30(3450MHz) 20(11000MHz)	2.0	50	2.00x1.20x1.00	B
RFBPF2012100K0T	4.9-5.9	1.7(4.90GHz) 1.5(5.25GHz) 1.5(5.85GHz)	30(3450MHz) 20(11000MHz)	2.0	50	2.00x1.20x1.00	B
RFBPF2012090K5T	4.9-5.85	2.2max.(25°C) 2.5max.(-40~+85°C)	35(340-1195MHz) 19(2140-3580MHz) 25(6855-7150MHz) 20(8570-8930MHz)	2.0	50	2.00x1.20x0.90	B
RFBPF2012100K3T	4.9-5.85	1.8max.(25°C) 2.1max.(-40~+85°C)	30(500MHz) 35(3450MHz) 30(4000MHz) 20(4200MHz) 15(9800MHz) 15(11700MHz)	2.0	50	2.00x1.20x0.95	B
RFBPF2012100K6T	5.15-5.85	1.6max.(25°C) 1.8max.(-40~+85°C)	30(500MHz) 40(2000MHz) 35(3450MHz) 30(4000MHz) 20(4200MHz)	2.0	50	2.00x1.20x0.95	B
RFBPF2012090K9T	5.725-5.85	2.0	30(500MHz) 30(4000MHz) 20(4200MHz) 32(5000MHz) 15(9800MHz) 15(11750MHz)	2.0	50	2.00x1.20x0.95	B
RFBPF2520090K1T	4.9-5.85	1.2max.(25°C) 1.5max.(-40~+85°C)	50(824-1910MHz) 15(9880-11700MHz)	2.0	50	2.50x2.00x0.90	A
KFBPF25204G7W09S5K	4.4-4.94	3.5	50(1000MHz) 35(2500MHz) 20(3500MHz) 7(4250MHz) 15(5150MHz) 20(57500MHz)	2.0	50	2.50x2.00x0.80	A

WiMAX BAND WORKING FREQUENCY

Part Number	Frequency Range(GHz)	Insertion Loss (dB)	Attenuation (dB min.)	VSWR (max.)	Impedance (Ω)	Size(mm)	STRUCTURE
RFBPF16082G3W0T	2.3-2.39	2.0	29(880-915MHz) 29(1710-1785MHz) 21(1850-1910MHz) 15(1920-1980MHz) 18(4600-4780MHz) 23(6900-7170MHz)	2.0	50	1.60x0.80x0.70	B

1558 ~ 1606 MHz GNSS Band Applications

Part Number	Frequency Range (MHz)	Insertion Loss (dB)	Attenuation (dB min.)	VSWR (max.)	Impedance (Ω)	Size(mm)	STRUCTURE
RFBPF1109060E0T	1550-1610	1.9max.	25(960MHz) 8(1850MHz) 15(1990MHz) 20(2170MHz) 35(2400-2500MHz) 35(3400-3800MHz)	2.0	50	1.10x0.90x0.60	E
RFBPF1411070E0T	1558-1606	1.8max.(25°C) 2.0max.(-40~+85°C)	30(824-849MHz) 30(880-915MHz) 10(1880-1910MHz) 22(1920-1980MHz) 30(2400MHz)	2.0	50	1.40x1.10x0.70	E

860~960MHz/1805~2025 MHz Band Application

Part Number	Frequency Range (MHz)	Insertion Loss (dB)	Attenuation (dB min.)	VSWR (max.)	Impedance (Ω)	Size(mm)	STRUCTURE
RFBPF2520090B08Q1C	869-960	0.7max.(25°C) 0.75max.(-40~+85°C)	25(430-490MHz) 10(1700-1900MHz) 20(2400-2500MHz) 20(4905-5845MHz)	1.9	50	2.50x2.00x0.90	J
	1805-2025	1.1max.(25°C) 1.2max.(-40~+85°C)	25(900-1015MHz) 15(2400-2500MHz) 15(3610-3980MHz) 20(4905-5845MHz)	2.0			

MoCA / Docsis Application

Part Number	Frequency Range(MHz)	Insertion Loss (dB)	Attenuation (dB min.)	VSWR (max.)	Impedance (Ω)	Size(mm)	STRUCTURE
RFBPF3225180Y1T	975-1025	3.0	30(54-870MHz) 30(1125-1675MHz) 30(2300MHz)	2.0	75	3.20x2.50x1.80	K
RFBPF3225200Y07B1U	475-675	2.5max.(25°C) 2.7max.(-40~+85°C)	60(2.5MHz) 40(2.5-100MHz) 35(100-200MHz) 35(200-300MHz) 8(300-400MHz) 57(950MHz) 47(950-2025MHz) 41(2025-2500MHz) 35(2500-3000MHz)	2.0	75	3.20x2.50x1.80	K
RBBPF3225180Y27B1U	400-700	2.0	42(1-200MHz) 30(950-2150MHz) 35(2150-3000MHz) 27(3000-5900MHz)	2.0	50	3.20x2.50x1.80	K
KFBPF2012100C67B1U	1125-1675	2.5	35(1-900MHz) 20(900-1002MHz) 35(2000-2500MHz) 20(2500-5900MHz)	2.0	50	2.00x1.25x1.05	K
RFBPF3225180C07B1U	1125-1675	1.8max.(25°C) 2.0max.(-40~+85°C)	30(5-864MHz) 34(864-1002MHz) 32(2300-3000MHz)	2.0	75	3.20x2.50x1.80	K
RBBPF3225180C67B1U	1125-1675	2.0	40(1-900MHz) 25(900-1002MHz) 35(2000-2500MHz) 27(2500-5900MHz)	2.0	50	3.20x2.50x1.80	K

LTE Band Application

Part Number	Frequency Range(MHz)	Insertion Loss (dB)	Attenuation (dB min.)	VSWR (max.)	Impedance (Ω)	Size(mm)	STRUCTURE
RFBPF1109B101T	2110-2170	1.7	25(4280MHz)	2	50	1.10x0.90x0.60	E
RFBPF1109B201T	1930-1990	1.7	25(3920MHz)	2	50	1.10x0.90x0.60	E
RFBPF1109B301T	1805-1880	1.4	25(3685MHz)	2	50	1.10x0.90x0.60	E
RFBPF1109B501T	869-894	0.9	12(1763MHz)	2	50	1.10x0.90x0.60	E
RFBPF1109B701T	2620-2690	1.2	25(5310MHz)	2	50	1.10x0.90x0.60	E
RFBPF1109B801T	925-960	0.9	12(1885MHz)	2	50	1.10x0.90x0.60	E
RFBPF16081G9DM1T79	1805-2025	1.6max.(25°C) 1.8max.(-40~+85°C)	25(700-950MHz) 15(950-1050MHz) 25(2400-2500MHz) 35(2700-5150MHz) 40(5150-5850MHz) 25(5850-12750MHz)	2	50	1.60x0.80x0.70	G
RFBPF16081G9DMAT79	1880-2025	2.0max.(25°C) 2.2max.(-40~+85°C)	20(1545-1610MHz) 25(2400-2500MHz) 25(5150-5850MHz)	2	50	1.60x0.80x0.70	G
RFBPF16081G9DS8T60	1805-2025	1.6	30(700-950MHz) 15(950-1050MHz) 25(2400-2500MHz) 35(2700-5400MHz) 35(5500-6200MHz) 35(9350-10150MHz) 20(10500-12750MHz)	2	50	1.60x0.80x0.70	G

■ TYPICAL ELECTRICAL CHARACTERISTICS

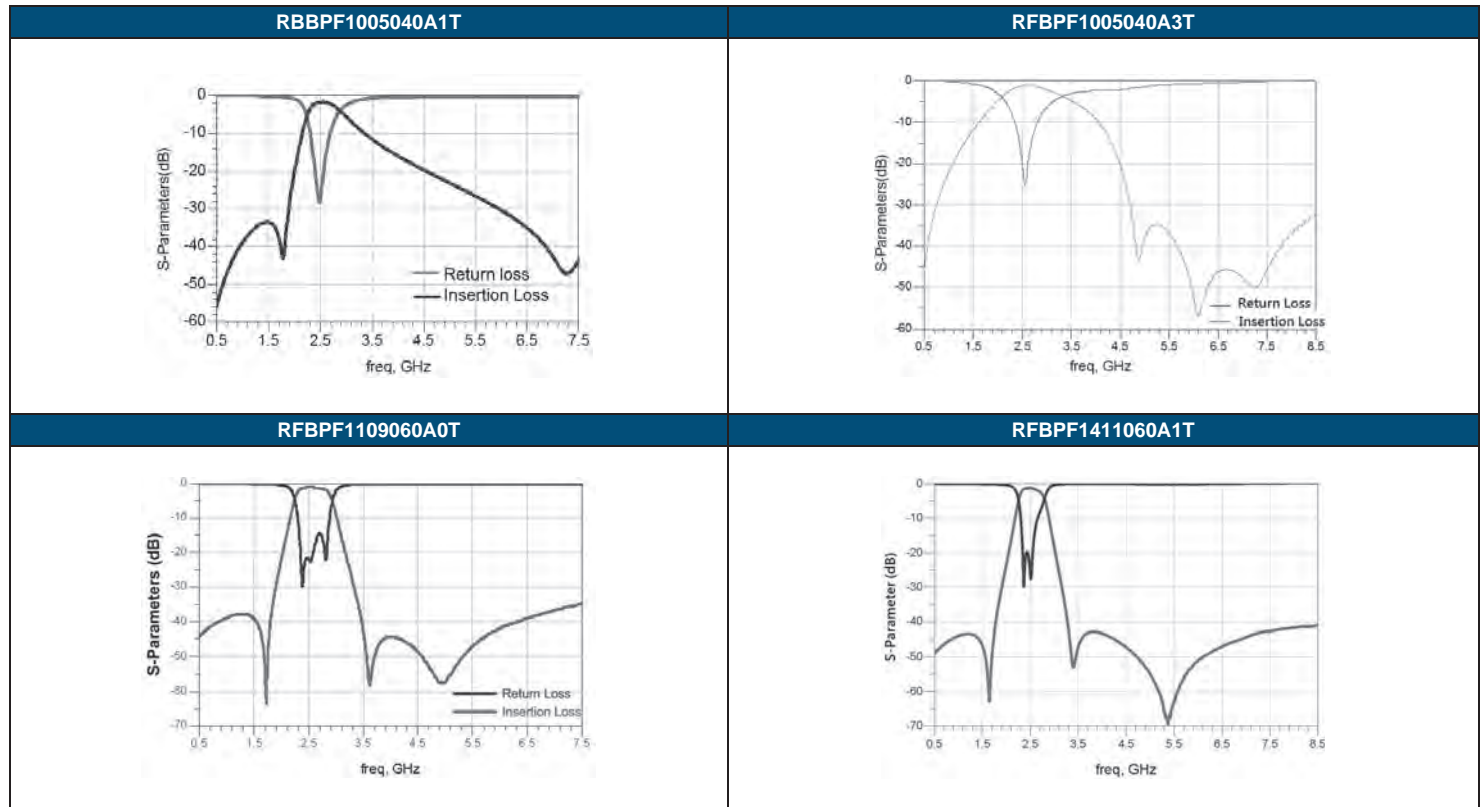

TYPICAL ELECTRICAL CHARACTERISTICS

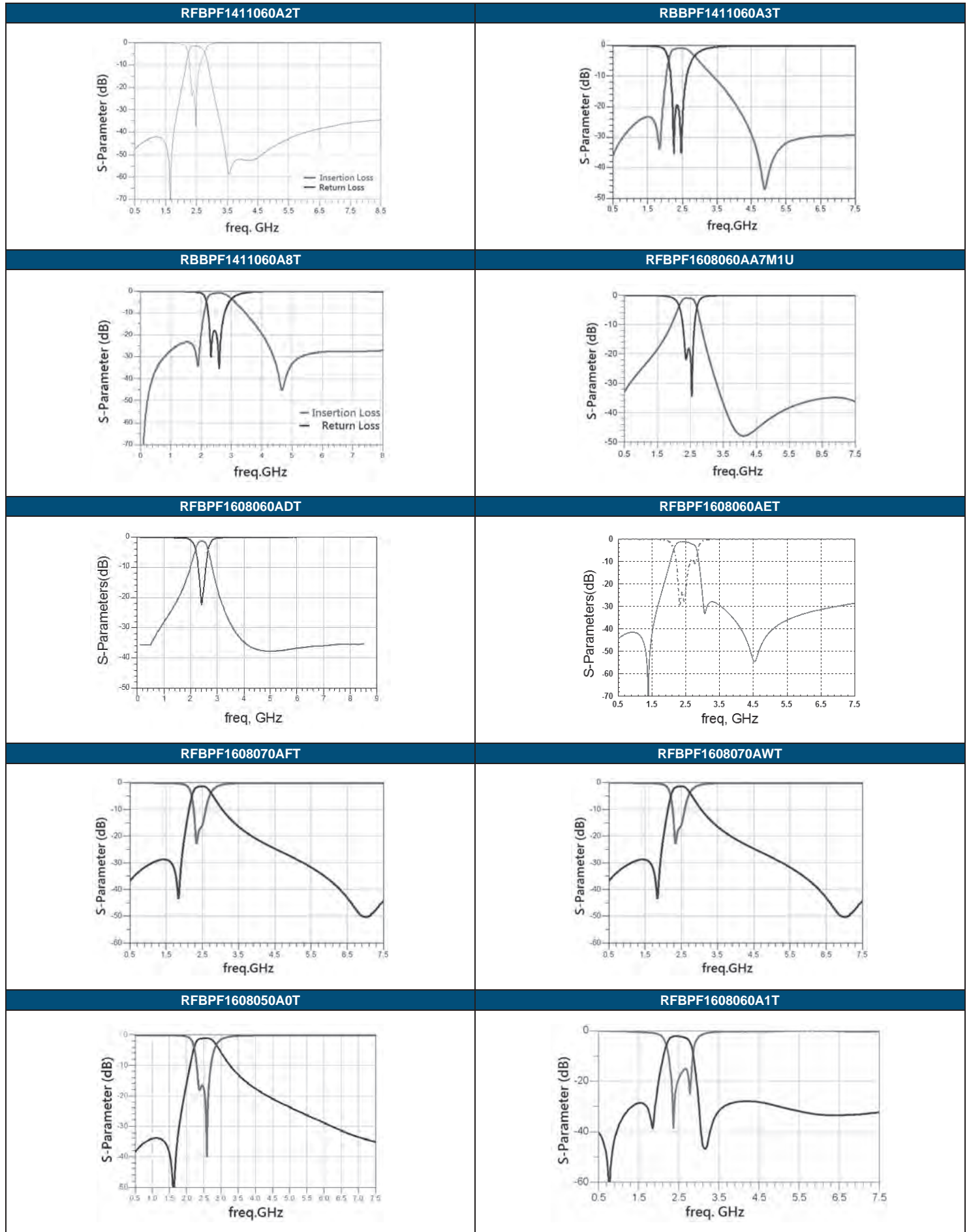

TYPICAL ELECTRICAL CHARACTERISTICS

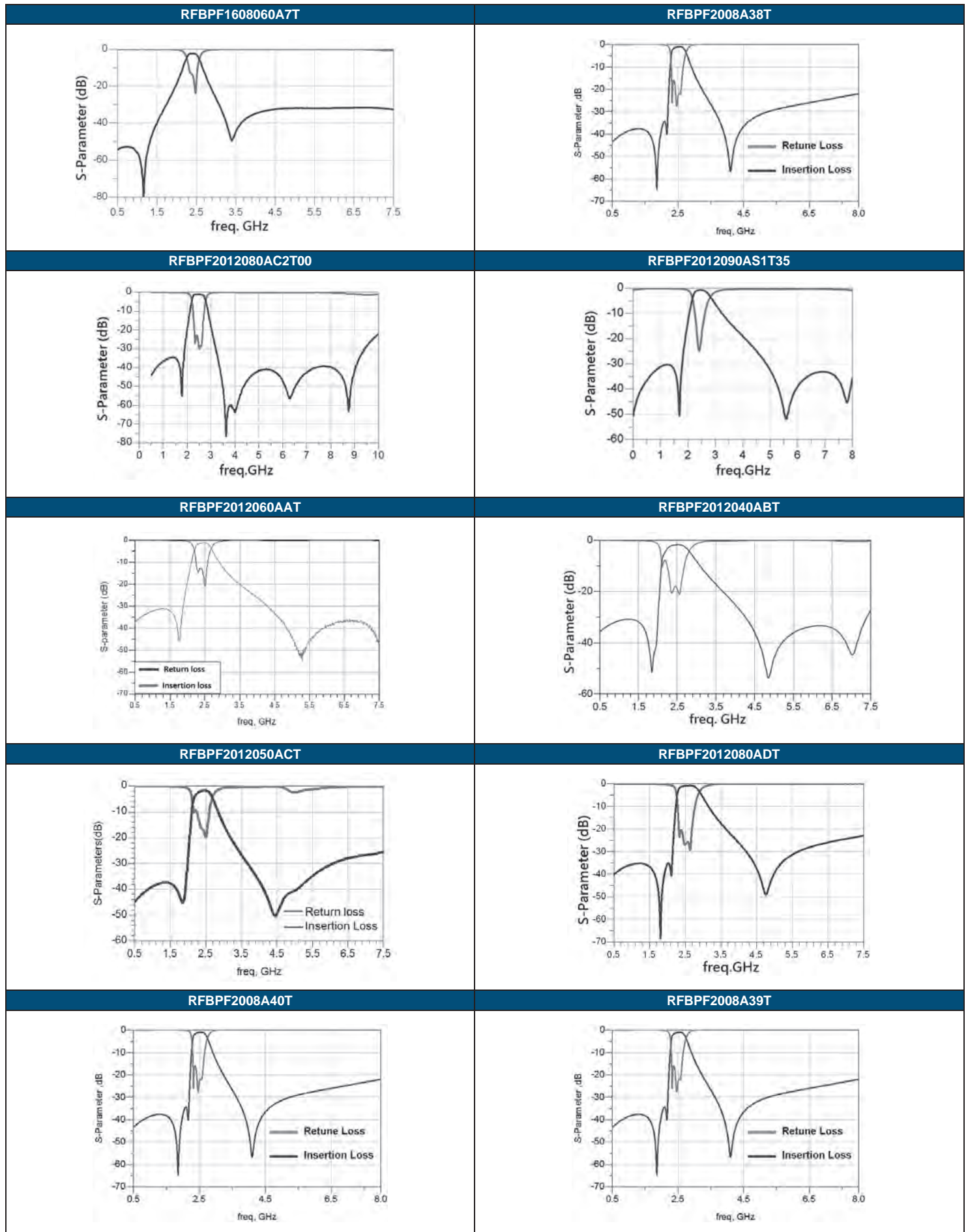

TYPICAL ELECTRICAL CHARACTERISTICS

RFBPF2012040AHT

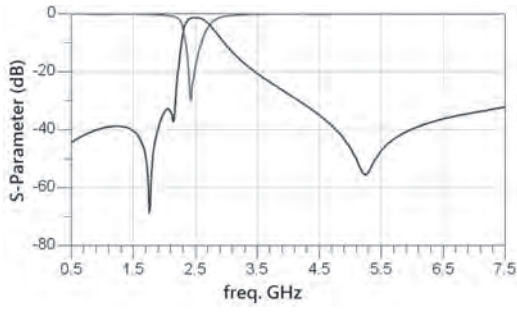

RBBPF2012050AHT

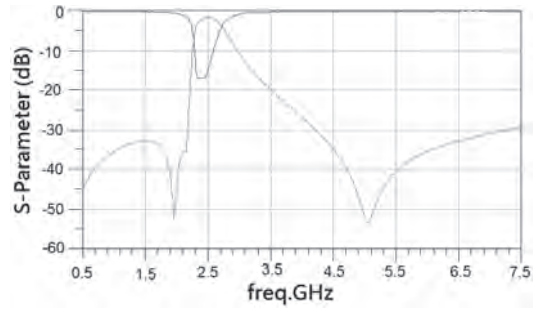

RFBPF2012090ALT

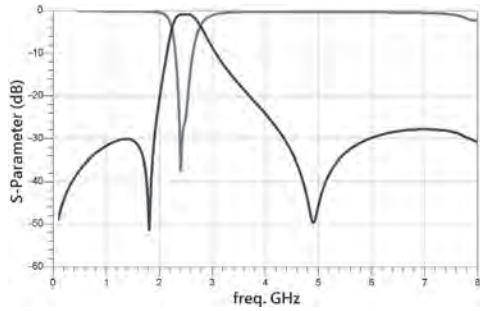

RFBPF2012090AMT

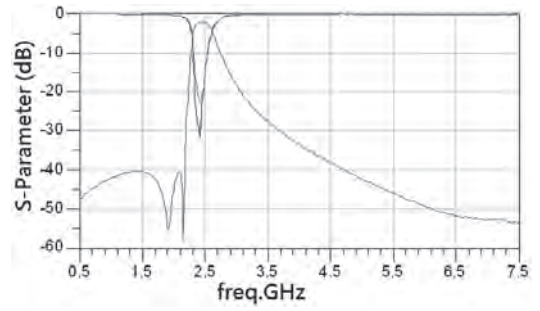

RFBPF2012100ANT

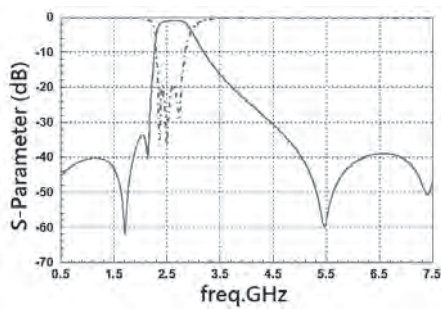

RFBPF2012090AQT

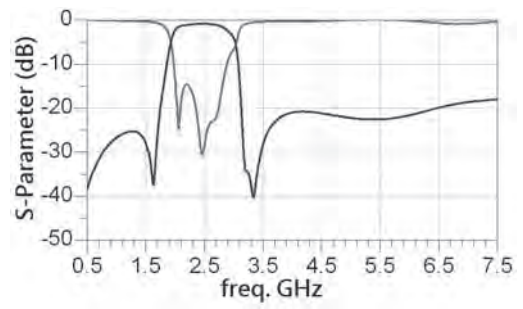

RFBPF2012090ART

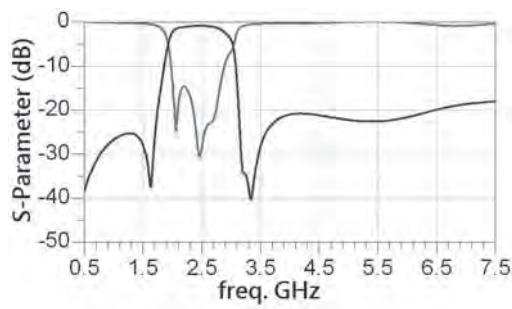

RFBPF2012100AVT

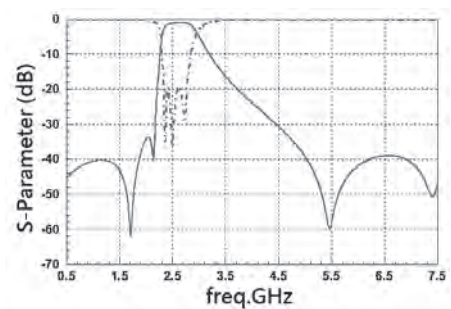

RBBPF2010A108Q1C

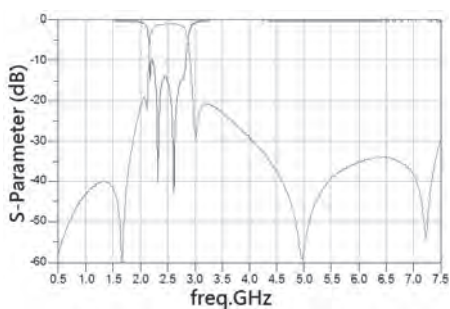

RFBPF2009A12T

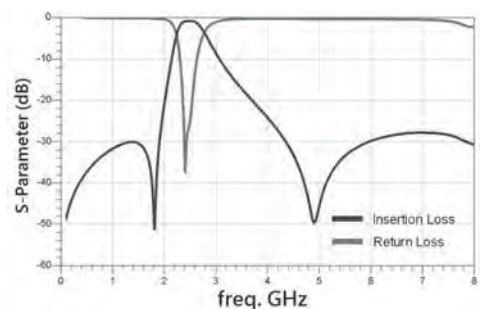

TYPICAL ELECTRICAL CHARACTERISTICS

RBBPF2010A16T

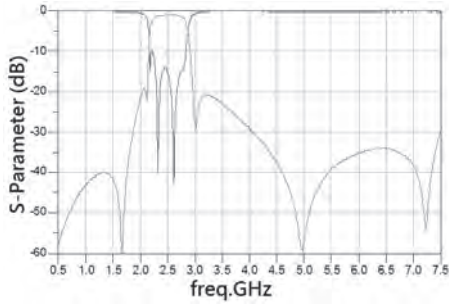

RFBPF2009A25T

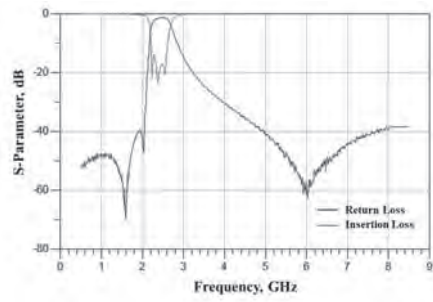

RFBPF2009A26T

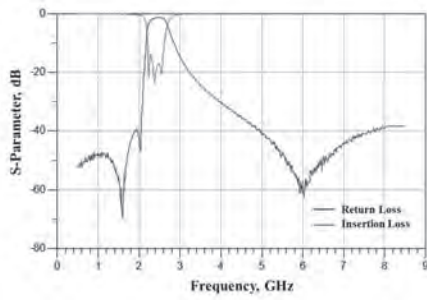

RFBPF2012040A3T

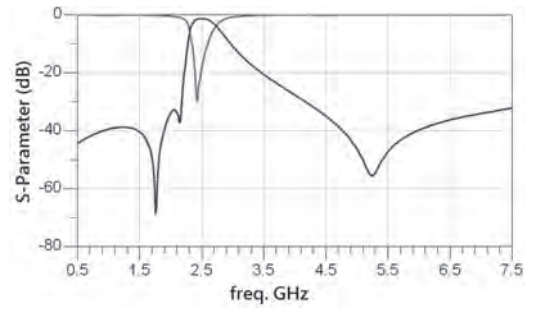

RFBPF2012080A6T

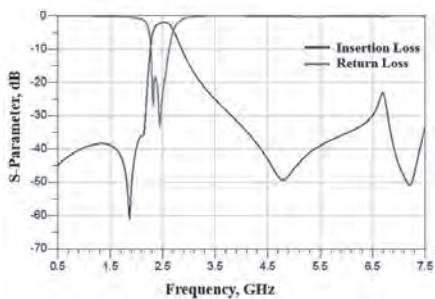

RFBPF2012100A6T

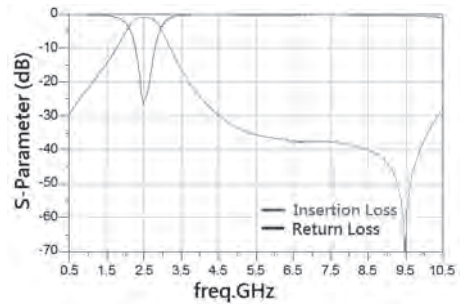

RFBPF2012080A7T

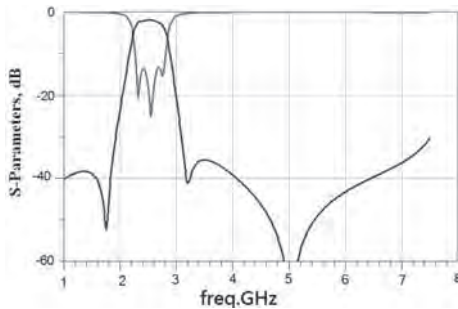

RFBPF2520090ACT

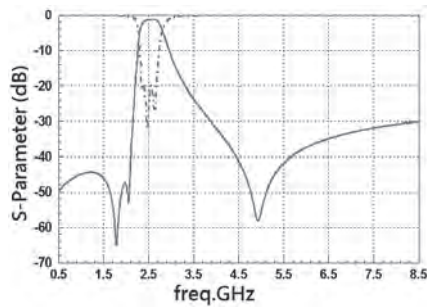

RFBPF2520070AMT

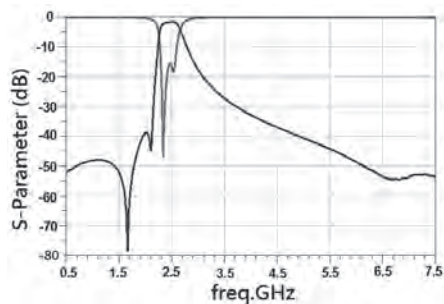

RFBPF2520080AUT

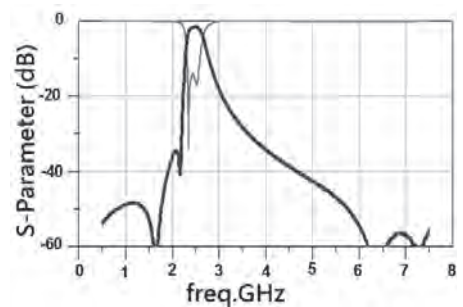

TYPICAL ELECTRICAL CHARACTERISTICS

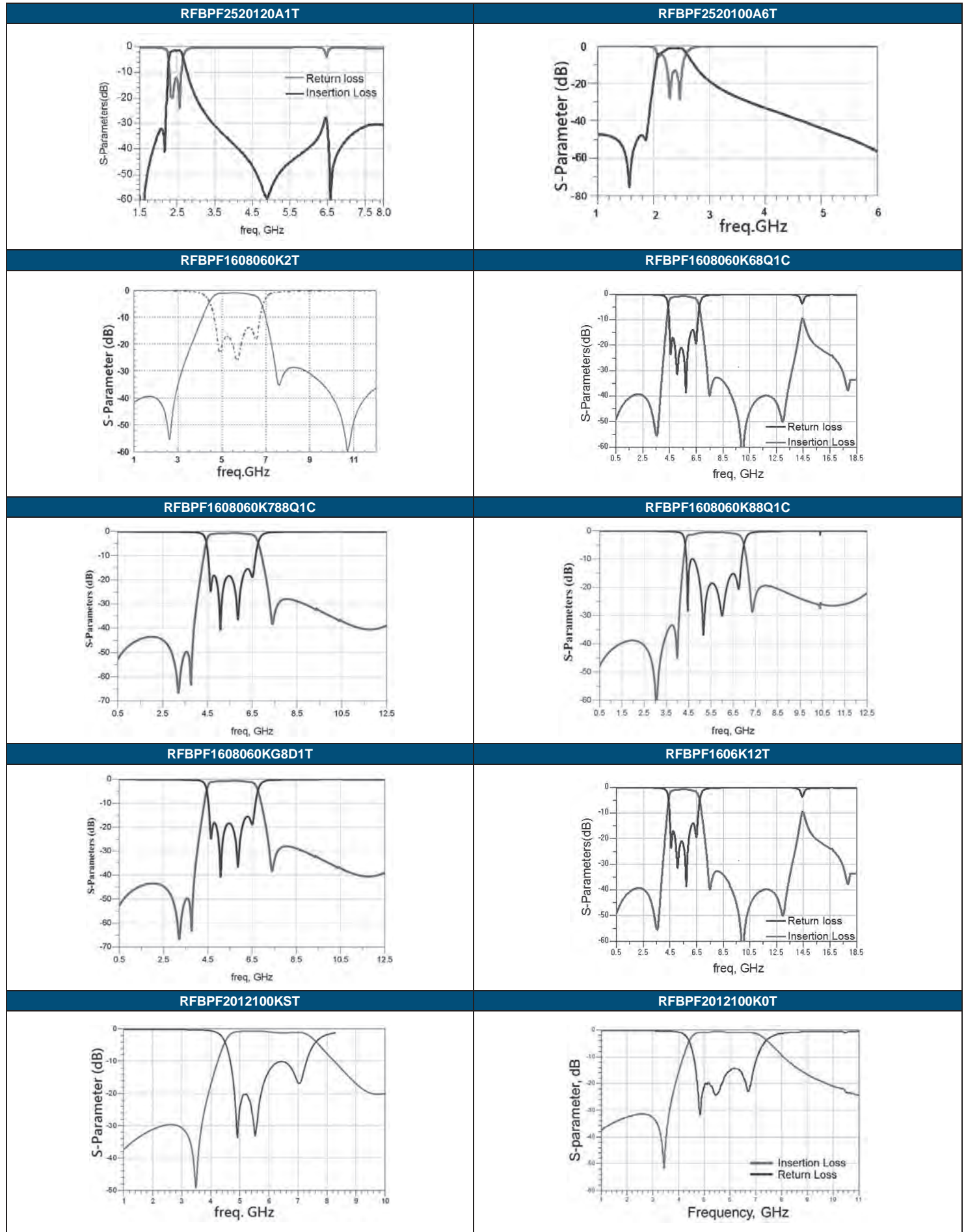

TYPICAL ELECTRICAL CHARACTERISTICS

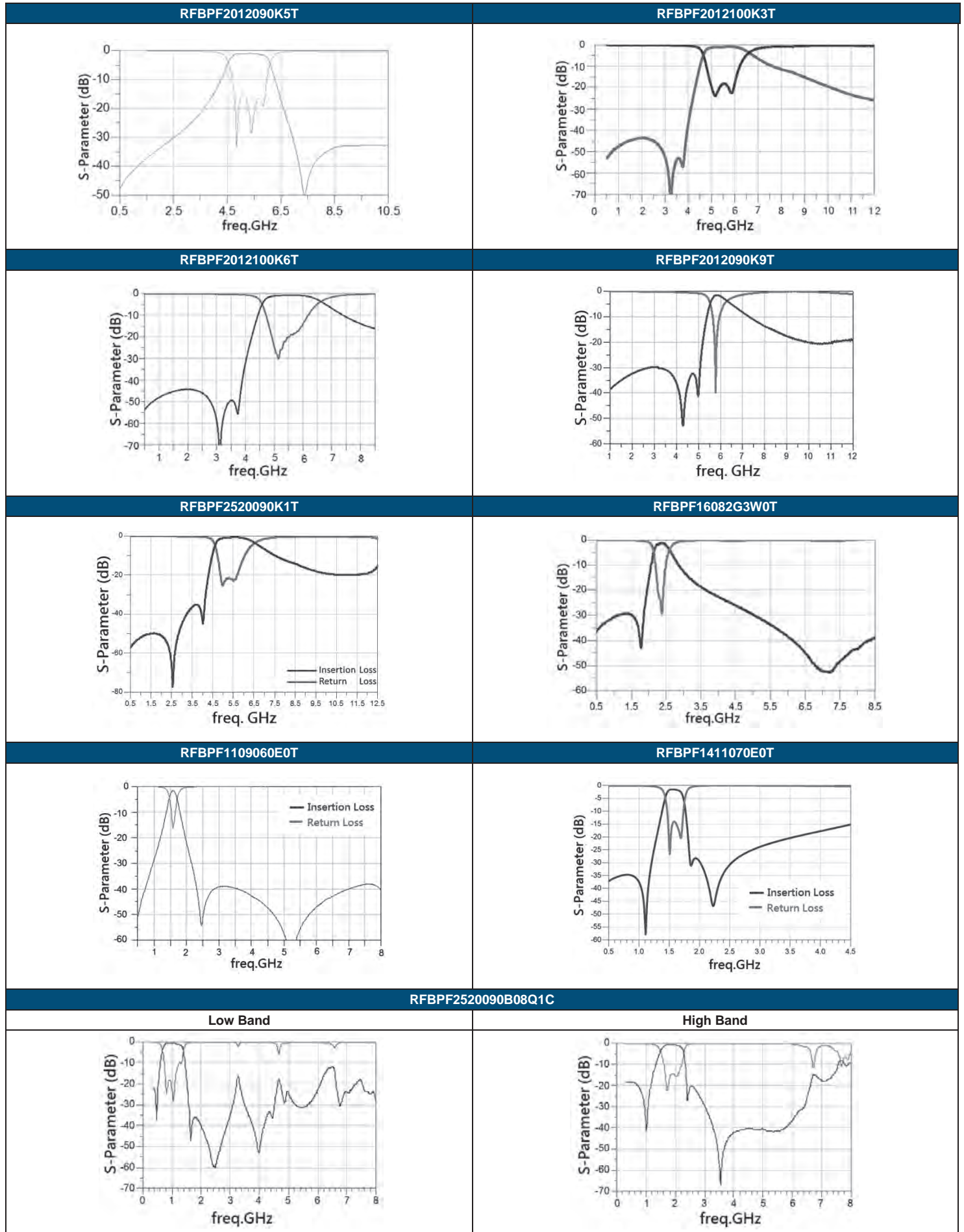

TYPICAL ELECTRICAL CHARACTERISTICS

RFBPF3225180Y1T

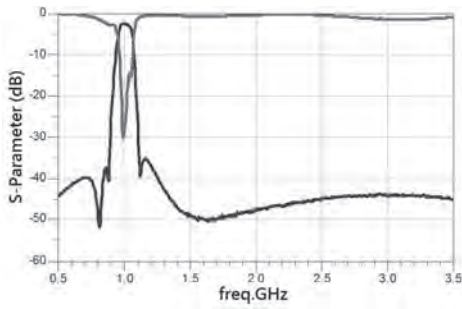

RFBPF3225200Y07B1U

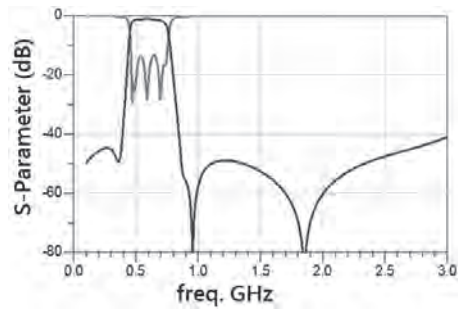

RBBPF3225180Y27B1U

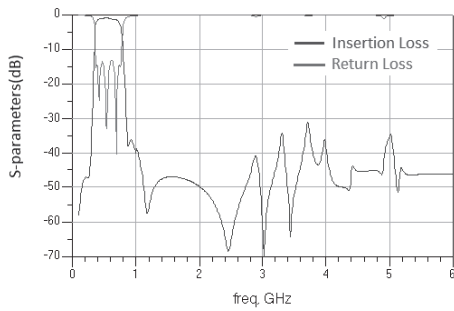

KFBPF2012100C67B1U

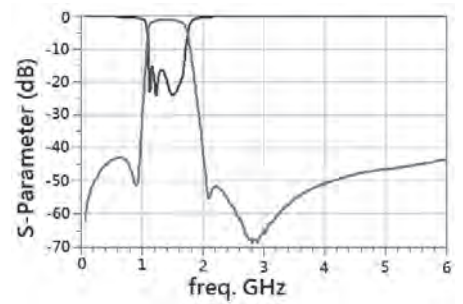

RFBPF3225180C07B1U

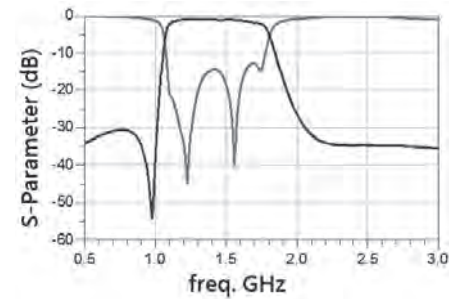

RBBPF3225180C67B1U

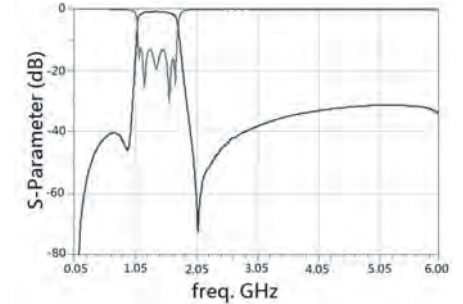

RFBPF1109B101T

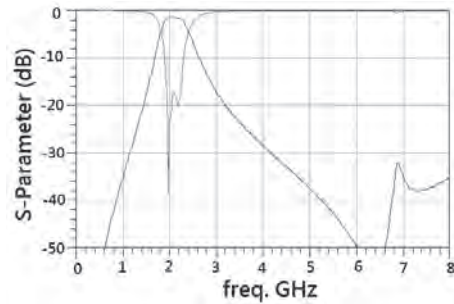

RFBPF1109B201T

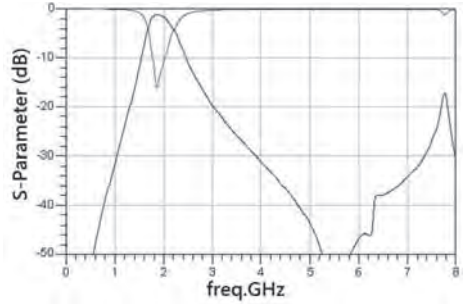

RFBPF1109B301T

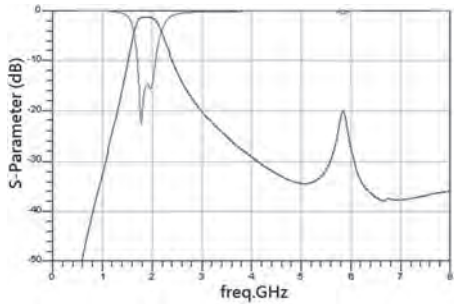

RFBPF1109B501T

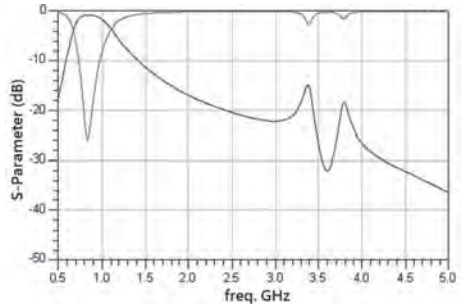

TYPICAL ELECTRICAL CHARACTERISTICS

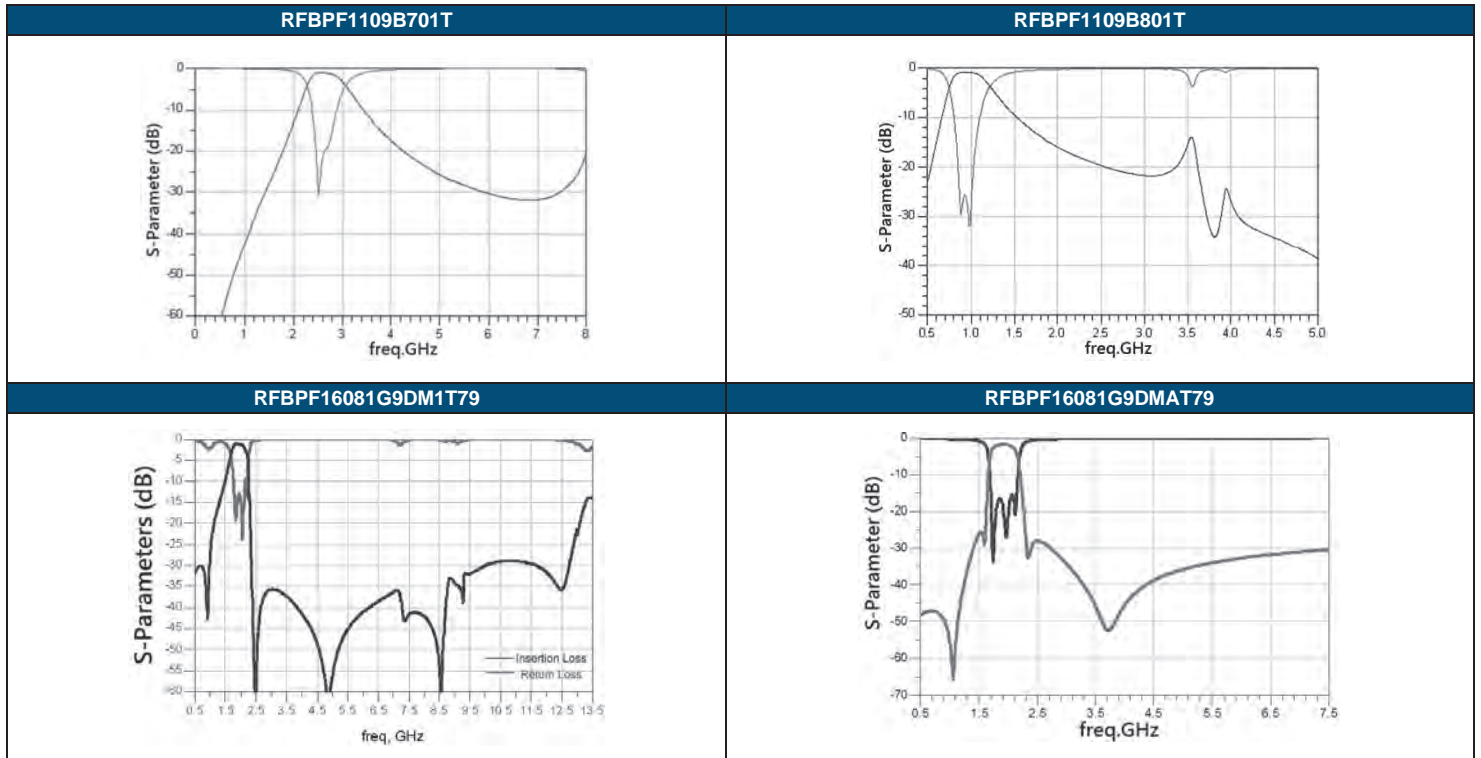

- For more information, please contact with local sales representative
- All specifications are subject to change without notice

HIGH FREQUENCY MULTILAYER BALANCED FILTER

■ **STRUCTURE AND PIN ASSOCIATED**

STRUCTURE A

STRUCTURE A-1

STRUCTURE B

■ **STRUCTURE AND DIMENSION**

Unit: mm

Structure\ Dimension	L	W	T	A	B	C	D	E	F	G	
A	1.60±0.15	0.80±0.15	0.60±0.10	0.175±0.15	0.25±0.15	0.25±0.15	0.50±0.15	0.20±0.15	0.20±0.15	0.30±0.15	
	2.00±0.15	1.25±0.15	1.20±0.10	0.40±0.10	0.175±0.10	0.35±0.15	0.30±0.15	0.65±0.10	0.20±0.10	0.20±0.15	0.50±0.10
			0.50±0.10	0.20±0.15	0.30±0.15	0.35±0.15	0.35±0.15	0.65±0.15	0.20±0.15	0.20±0.15	0.30±0.15
			0.60±0.10	0.20±0.15	0.30±0.10	0.35±0.10	0.35±0.10	0.65±0.10	0.20±0.15	0.20±0.15	0.50±0.10
			0.90±0.10	0.20±0.15	0.30±0.10	0.35±0.10	0.35±0.10	0.65±0.10	0.20±0.15	0.20±0.15	0.30±0.10
			1.00±0.10	0.20±0.15	0.30±0.10	0.35±0.10	0.35±0.10	0.65±0.10	0.20±0.10	0.20±0.15	0.50±0.10
			1.10±0.10	0.20±0.15	0.30±0.10	0.35±0.10	0.35±0.10	0.65±0.10	0.20±0.15	0.20±0.15	0.55±0.10
	2.50±0.20	2.00±0.20	0.85±0.10	0.35±0.20	0.40±0.10	0.30±0.10	0.70±0.20	0.15(Typical)	0.15(Typical)	1.20±0.20	
B	1.95±0.15	1.25±0.15	0.80±0.10	0.175±0.15	0.30±0.15	0.35±0.15	0.65±0.15	0.25±0.15	-	-	
	2.00±0.15	1.25±0.10	0.60±0.10	0.20±0.10	0.30±0.15	0.35±0.15	0.65±0.10	0.25±0.10	-	-	

■ **ELECTRICAL SPECIFICATION**

2.4GHz BAND WORKING FREQUENCY

Part Number	Frequency Range (MHz)	Impedance(Ω)		Insertion Loss (dB)	Attenuation (dB min.)	VSWR (Max.)	Phase Difference	Amplitude Difference	Size (mm)	STRUCTURE
		Unbalance	Balance							
RFBPB2012090A1T	2.4-2.5	50	Conjugate match to BC series of Bluetooth chipset	3.5	35(880-960MHz) 30(1710-1880MHz) 20(1880-1990MHz) 30(4800-5000MHz)	2.1	180°± 10	2	2.00x1.25x0.90	A-1
RFBPB2012090A9T	2.4-2.5	50	Conjugate match to BC series of Bluetooth chipset	2.8	35(880-960MHz) 30(1575MHz) 25(1710-1880MHz) 30(4800-5000MHz)	2.1	180°± 10	2	2.00x1.25x0.90	A-1
RFBPB2012090AAT	2.4-2.5	50	Conjugate match to CSR BC03/ 04 series	3.5	35(880-960MHz) 30(1710-1880MHz) 20(1880-1990MHz) 30(4800-5000MHz)	2.1	180°± 10	2	2.00x1.25x0.90	A-1
RFBPB2012060ABT	2.4-2.5	50	Impedance match to T.I. CC253X,CC254X, CC257X, CC853X and CC852X Chipsets	1.5max.(25°C) 1.7max. (-40~+85°C)	12(1000MHz) 15(4800-5000MHz) 20(7200-7500MHz)	2.0	180°± 15	2	2.00x1.25x0.60	B
RFBPB2012080AET	2.4-2.5	50	Impedance match to: Atmel AT86RF232, AT86RF233, ATMega256RF R2, Zigbit 256RFR2, Zigbit RF233, ZigBit RF233+FEM, Extension RF233, USB RF233	1.5max.(25°C) 1.7max. (-40~+85°C)	20(4800-5000MHz) 20(7200-7500MHz)	2.0	180°± 10	2	1.95x1.25x0.80	B
RFBPB2012090AHT	2.4-2.5	50	100	3.5	30(880-960MHz) 30(1710-1880MHz) 20(1880-1990MHz) 30(4800-5000MHz)	2.0	180°± 10	2	2.00x1.25x0.90	A-1
RFBPB2012090AM1T59	2.4-2.5	50	Conjunction to MT5931/MT6628 Chipset	2.5 (typ.2.2)	35(824-960 MHz) 32(1990 MHz) 18(2170 MHz) 40(4800-5000MHz) 25(7200-7500MHz)	2.0	180°± 10	2	2.00x1.25x0.95	A-1
RFBPB2012090AM1T61	2.4-2.5	50	Conjugate match to MTK MT6611 Bluetooth chipset	2.8	35(880-960MHz) 30(1710-1880MHz) 20(1880-1900MHz) 30(4800-5000MHz)	2.1	180°± 10	2	2.00x1.25x0.90	A-1
RFBPB2012100A6T	2.4-2.5	50	Conjugate match to BC series of Bluetooth chipset	3.5	35(880-960MHz) 30(1710-1880MHz) 20(1880-1900MHz) 40(4800-5000MHz)	2.0	180°± 10	2	2.00x1.25x1.00	A-1
RFBPB2012110A5T	2.4-2.5	50	50	2.8	30(880-960 MHz) 30(1710-1880MHz) 20(1880-1990 MHz) 30(4800-5000 MHz)	2.0	180°± 10	2	2.00x1.25x1.10	A-1
RFBPB2520090A7T	2.4-2.5	50	Conjugate match to TI BRF6150	3.5	35(880-960MHz) 30(1710-1880MHz) 25(1880-1990MHz) 25(4800-5000MHz)	2.0	180°± 15	1.5	2.50x2.00x0.90	A-2

■ **TYPICAL ELECTRICAL CHARACTERISTICS**

RFBPB2012090A1T

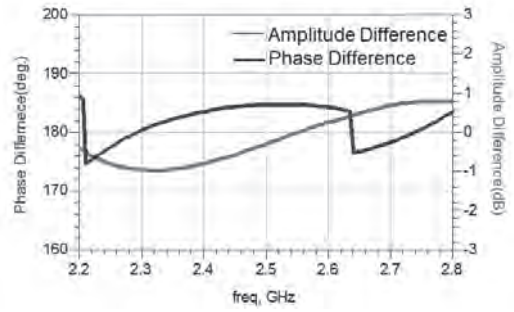
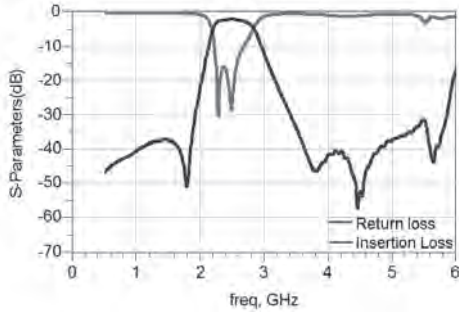

RFBPB2012090A9T

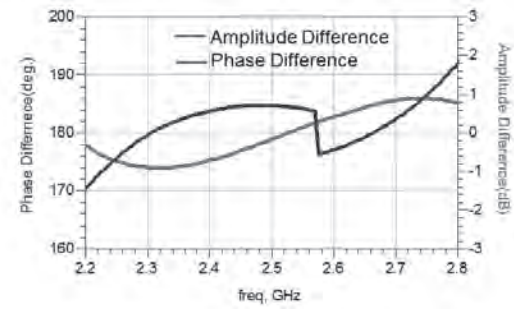
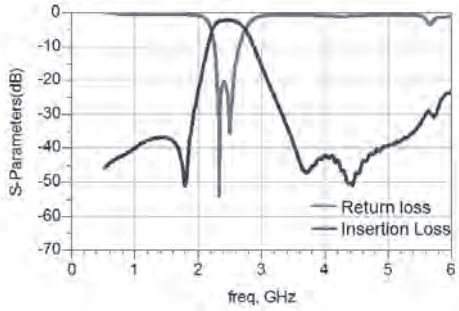

RFBPB2012060ABT

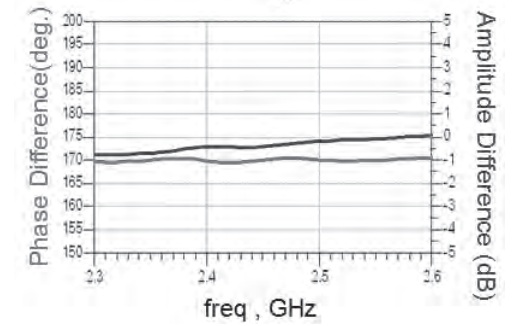

RFBPB2012080AET

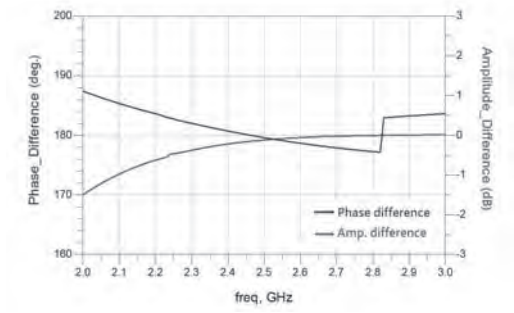
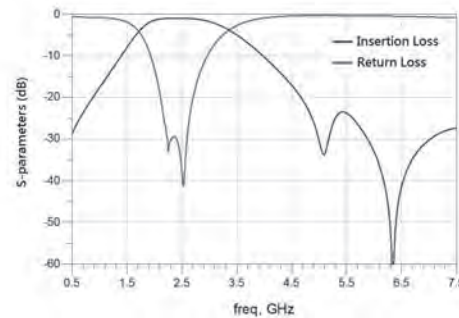

RFBPB2012090AHT

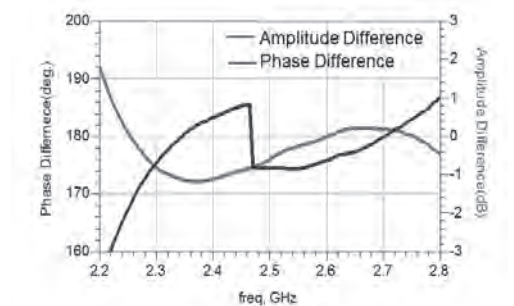
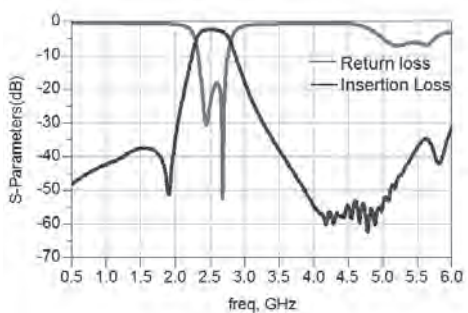

TYPICAL ELECTRICAL CHARACTERISTICS

RFBPB2012090AM1T59

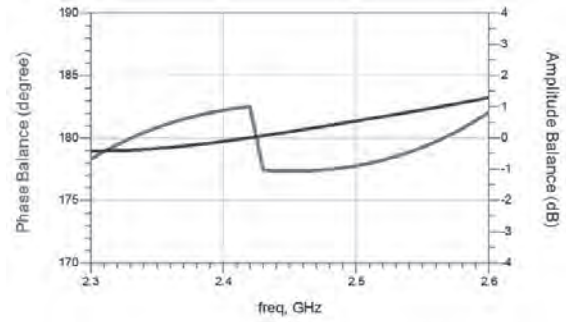
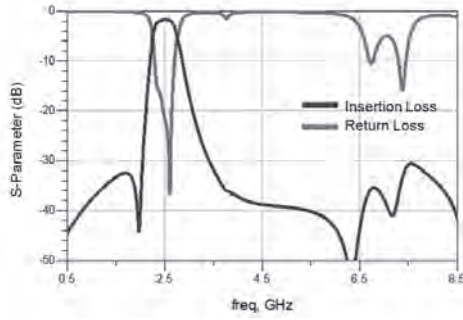

RFBPB2012090AM1T61

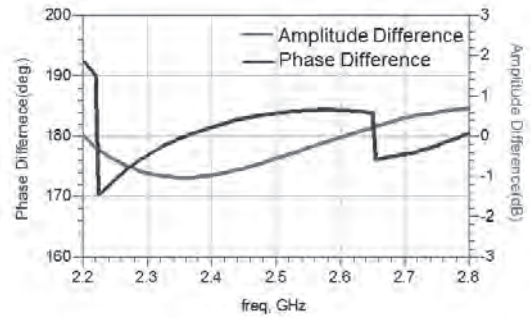
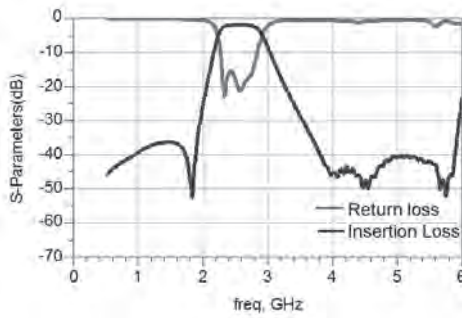

RFBPB2012100A6T

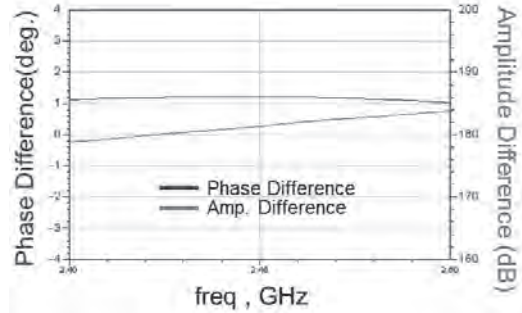
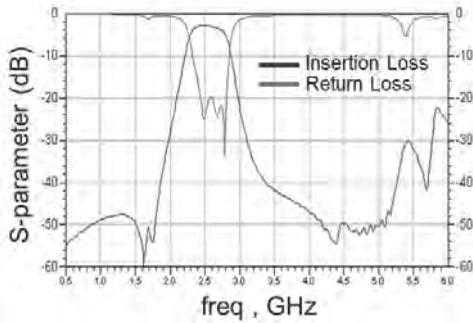

RFBPB2012090AM1T61

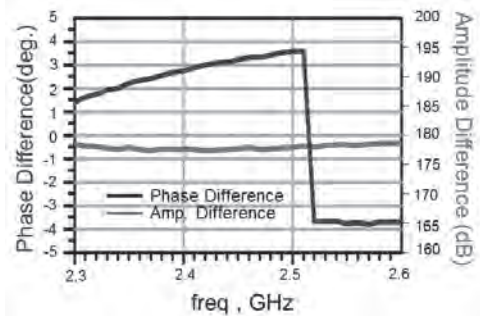
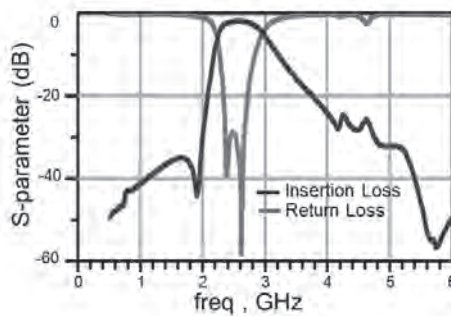

- For more information, please contact with local sales representative
- All specifications are subject to change without notice

HIGH FREQUENCY MULTILAYER LOW PASS FILTER

■ **STRUCTURE AND PIN ASSOCIATED**

STRUCTURE A		STRUCTURE C			
	<p>STRUCTURE A-1</p>	<p>STRUCTURE A-2</p>			
	<p>STRUCTURE A-3</p>	<p>STRUCTURE A-4</p>			
STRUCTURE B					
	<p>STRUCTURE B-1</p>	<p>STRUCTURE B-2</p>			
	<p>STRUCTURE B-1</p>	<p>STRUCTURE B-2</p>			
STRUCTURE D	STRUCTURE E	STRUCTURE F	STRUCTURE G	STRUCTURE H	STRUCTURE I

■ **STRUCTURE AND DIMENSION**

Unit: mm

Structure\Dimension	L	W	T	A	B	C	D	E	F
A	1.60±0.15	0.80±0.15	0.50max.	0.20±0.10	0.24±0.10	0.24±0.10	0.50±0.10	0.15±0.10	-
			0.60±0.10	0.175±0.15	0.25±0.15	0.25±0.15	0.50±0.15	0.20±0.15	-
			0.65±0.10	0.175±0.15	0.25±0.15	0.25±0.15	0.50±0.15	0.20±0.15	-
			0.70max.	0.175±0.15	0.25±0.15	0.25±0.15	0.50±0.15	0.20±0.15	-
B	2.00±0.15	1.25±0.10	0.90±0.10	0.20±0.10	0.30±0.10	0.35±0.10	0.65±0.10	0.20±0.10	0.20±0.10
			0.95±0.10	0.20±0.10	0.30±0.10	0.35±0.10	0.65±0.10	0.20±0.10	0.20±0.10
			1.05±0.10	0.20±0.10	0.30±0.10	0.35±0.10	0.65±0.10	0.20±0.10	0.20±0.10
			3.20±0.20	2.50±0.20	1.00±0.20	0.10min.	0.55±0.15	0.45±0.15	1.00±0.15
C	1.00±0.10	0.50±0.10	0.40±0.10	0.35±0.10	0.30±0.10	0.15±0.10	0.15±0.10	0.30±0.10	-
			1.60±0.15	0.80±0.15	0.50max.	0.45±0.15	0.70±0.15	0.20±0.15	0.20±0.15
D	0.65±0.10	0.50±0.10	0.40max.	0.225±0.10	0.20±0.05	0.10±0.05	0.25±0.05	0.025±0.25	-
E	1.60±0.15	0.80±0.15	0.65max.	0.23±0.05	0.40±0.10	0.30±0.10	0.65±0.10	0.20±0.05	0.23±0.05
			0.60±0.10	0.23±0.05	0.40±0.10	0.30±0.10	0.65±0.10	0.20±0.05	0.23±0.05
			0.70max.	0.25±0.10	0.40±0.10	0.23±0.10	0.55±0.10	0.21±0.10	0.195±0.10
F	1.60±0.10	0.80±0.10	0.65max.	0.55±0.10	0.25±0.10	0.25±0.10	0.40±0.10	0.12±0.10	0.125±0.10
				0.60±0.10	0.25±0.10	0.25±0.10	0.40±0.10	0.10±0.05	0.10±0.05
	2.00±0.15	1.25±0.10	0.90±0.10	0.95±0.10	0.275±0.10	0.25±0.10	0.60±0.10	0.175±0.10	0.15±0.10
G	1.00±0.10	0.50±0.10	1.00max.	0.95±0.10	0.275±0.10	0.25±0.10	0.60±0.10	0.175±0.10	0.15±0.10
			0.40 max.	0.18±0.05	0.18±0.05	0.05±0.05	0.125±0.05	0.15±0.05	0.05±0.05
H	3.20±0.20	2.50±0.20	1.00±0.20	0.95±0.20	0.60±0.20	0.30±0.15	0.70±0.15	1.20±0.15	2.00±0.15
			1.80±0.20	0.95±0.20	0.60±0.20	0.30±0.15	0.70±0.15	1.20±0.15	2.00±0.15
I	1.60±0.15	0.80±0.10	0.70±0.10	0.20±0.10	0.50±0.10	0.35±0.10	0.15±0.10	-	-

■ **ELECTRICAL SPECIFICATION**

GSM850/900GHz BAND WORKING FREQUENCY

Part Number	Frequency Range (MHz)	Insertion Loss (dB)	Attenuation (dB min.)	VSWR (max.)	Impedance (Ω)	Size(mm)	Structure
RFLPF06050G9D0T	824-915	0.5max.(25°C) 0.7max.(-40~+85°C)	20(2400-2750MHz)	2.0	50	0.65x0.50x0.40	D
RFLPF06050G9D2T	699-960	0.5max.(25°C) 0.7max.(-40~+85°C)	20(2400-2750MHz)	2.0	50	1.00x0.50x0.40	D
RFLPF10050G9D0T	824-915	0.6	25(1648-1830MHz) 25(2472-2745MHz) 25(3296-3660MHz)	2.0	50	1.00x0.50x0.40	C
RFLPF10050G9D3T	824-915	0.5max.(25°C) 0.7max.(-40~+85°C)	25(1648-1830MHz) 25(2472-2745MHz) 25(3296-3660MHz)	2.0	50	1.00x0.50x0.40	C
RFLPF10050G9D4T	699-915	0.5max.(25°C) 0.7max.(-40~+85°C)	25(1648-1830MHz) 25(2472-2745MHz) 25(3296-3660MHz)	2.0	50	1.00x0.50x0.40	C
RFLPF10050G9D58Q1C	814-915	0.5max.(25°C) 0.65max.(-40~+85°C)	18(1648-1830MHz) 17(2472-2745MHz)	2.0	50	1.00x0.50x0.40	C
RFLPF16080G9D4T	698-960	0.60(698-830MHz) 0.70(830-900MHz) 0.75(900-915MHz) 0.90(915-960MHz)	30(1554-1830MHz) 35(2097-2745MHz)	1.6	50	1.60x0.80x0.65	A-3
RFLPF16080G9DET	698-960	0.4max.(25°C) 0.45max.(-40~+85°C)	15(1574-1605MHz) 23(1648-1830MHz) 23(1805-1850MHz) 23(4944-5850MHz)	2.0	50	1.60x0.80x0.60	E
RFLPF16080G9DJT	434-960	0.6max.(25°C) 0.8max.(-40~+85°C)	25(1554-1610MHz) 30(1710-2700MHz)	2.0	50	1.60x0.80x0.65	A-1
RFLPF16080G9DM1T58	698-960	0.8	16(1565-1610MHz) 32(2110-2155MHz)	2.0	50	1.60x0.80x0.50	A-4
RFLPF10050G9DM1T76	698-960	0.6max.(25°C) 0.65max.(-40~+85°C)	13(1554-1610MHz) 35(1805-1830MHz) 35(2110-2170MHz) 30(1710-2700MHz)	2.0	50	1.00x0.50x0.40	G
RFLPF20120G9D0T	890-915	0.6max.(25°C) 0.75max.(-40~+85°C)	30(1780-1830MHz) 30(2670-2745MHz)	2.0	50	2.00x1.25x0.95	B-2
RFLPF20120G9D1T	890-915	0.6max.(25°C) 0.75max.(-40~+85°C)	40(1720-1765MHz) 30(1780-1830MHz) 30(2670-2745MHz)	2.0	50	2.00x1.25x0.95	B-2

DCS/PCS BAND WORKING FREQUENCY

Part Number	Frequency Range (MHz)	Insertion Loss (dB)	Attenuation (dB min.)	VSWR (max.)	Impedance (Ω)	Size(mm)	Structure
RFLPF10051G8D0T	1710-1910	0.8	35(3420-3570MHz) 35(3700-3820MHz) 35(5130-5730MHz)	2.0	50	1.00x0.50x0.40	C
RFLPF10051G8DM5T51	1710-1910	0.6	26(3420-3570MHz) 21(3700-3820MHz) 21(5130-5730MHz)	2.0	50	1.00x0.50x0.40	C
RFLPF10051G8D8T	1880-2025	1.4max.(25°C) 1.6max.(-40~+85°C)	10(2400-2500MHz) 22(3760-4050MHz) 22(5150-5850MHz) 22(5640-6075MHz)	2.0	50	1.00x0.50x0.40	G
RFLPF16081G8D3T	1710-1910	0.45max.(25°C) 0.55max.(-40~+85°C)	30(3420-3570MHz) 25(3700-3820MHz) 25(5130-5730MHz)	2.0	50	1.60x0.80x0.50	C
RFLPF16081G8D78Q1C	1880-2025	1.4	25(2400-2500MHz) 18(4020-4045MHz) 25(6030-6075MHz)	2.0	50	1.60x0.80x0.60	F
RFLPF16081G8DC8Q1C	1880-2170	0.60(1880-1920MHz) 0.70(1920-1980MHz) 0.80(2010-2170MHz) 2.00(2025-2170MHz)	15(2400-2500MHz) 20(3760-4050MHz) 12(5150-5850MHz) 12(5640-6075MHz) 5(7520-8100MHz)	2.0	20	1.60x0.80x0.60	E
RFLPF16081G8DHT	1710-1990	0.6max.(25°C) 0.8max.(-40~+85°C)	30.5(3420-3980MHz) 28.5(5130-5970MHz) 25.0(5970-12500MHz)	2.0	50	1.60x0.80x0.70	I
RFLPF20121G8D1T	1880-2025	1.35max.(25°C) 1.50max.(-40~+85°C)	38(2400-2500MHz) 25(4020-4045MHz) 27(6030-6075MHz)	1.9	50	2.00x1.20x0.90	F

2.4GHz BAND WORKING FREQUENCY

Part Number	Frequency Range (MHz)	Insertion Loss (dB)	Attenuation (dB min.)	VSWR (max.)	Impedance (Ω)	Size(mm)	Structure
RFLPF1005040A0T	2450±50	0.45max.(25°C) 0.55max.(-40~+85°C)	21(4800-5000MHz) 21(7200-7500MHz)	1.7	50	1.00x0.50x0.40	C
RFLPF1005040A1T	2450±50	0.75	33(4800-5000MHz) 37(7200-7500MHz)	2.0	50	1.00x0.50x0.40	C
RFLPF1005040A2T	2450±50	0.75max.(25°C) 0.90max.(-40~+85°C)	32(4800-5000MHz) 35(7200-7500MHz)	2.0	50	1.00x0.50x0.40	C
RFLPF1608060AAT	2450±50	0.65	20(3603-3720MHz) 30(4804-4960MHz) 10(6005-6200MHz) 20(7206-7440MHz) 10(8407-8680MHz) 20(9608-9920MHz) 10(10809-11160MHz) 10(12010-12400MHz) 10(13211-13640MHz) 15(14412-14880MHz) 10(15613-16120MHz) 10(16814-17360MHz)	2.0	50	1.60x0.80x0.70	A-1
RFLPF1608060ABT	2450±50	0.50	35(4800-5000MHz) 25(7200-7500MHz)	2.0	50	1.60x0.80x0.60	A-1
RFLPF1608060A0T	2450±50	0.65 (typ.0.48)	35(4800MHz(typ.40)) 27(7200MHz(typ.40))	1.5	50	1.60x0.80x0.60	A-1
RFLPF1608060A1T	2450±50	0.6	27(4800-5000MHz) 30(7200-7500MHz)	2.0	50	1.60x0.80x0.60	A-2
RFLPF1608060A2T	2450±50	0.42	25(4800MHz) 18(7200MHz)	1.5	50	1.60x0.80x0.60	A-1
RFLPF1608060A9T	2450±50	0.50max.(25°C) 0.60max.(-40~+85°C)	20(3400MHz) 20(3600MHz) 30(4800-5000MHz) 30(7200-7500MHz)	2.0	50	1.60x0.80x0.60	E
RFLPF2012110A0T	2450±50	0.7	30(2x(fo±BW/2)) 20(3x(fo±BW/2))	1.5	50	2.00x1.25x1.05	B-1

5GHz BAND WORKING FREQUENCY

Part Number	Frequency Range (MHz)	Insertion Loss (dB)	Attenuation (dB min.)	VSWR (max.)	Impedance (Ω)	Size(mm)	Structure
RFLPF1608050K0T	5400±500	0.60(25°C) 0.70(-40~+85°C)	25(9800MHz) 30(11900MHz) 20(17850MHz) (for reference)	2.0	50	1.60x0.85x0.50	C
RFLPF2012090K0T	5400±500	0.55(25°C) 0.65(-40~+85°C)	30(9800MHz) 30(11800MHz) 20(17550MHz) (for reference)	2.0	50	2.00x1.25x0.90	B-1

LTE BAND APPLICATION

Part Number	Frequency Range (MHz)	Insertion Loss (dB)	Attenuation (dB min.)	VSWR (max.)	Impedance (Ω)	Size(mm)	Structure
RFLPF1005040YM1T76	746-878	0.60(25°C) 0.65(-40~+85°C)	30(1554-1610MHz) 25(2238-2361MHz)	2.0	50	1.00x0.50x0.40	G
RFLPF1608060Y08Q1C	470-787	0.65(25°C) 0.71(-40~+85°C)	26(1429-1501MHz) 30(1565-1607MHz) 35(1570-1580MHz) 18(1920-1980MHz)	2.0	50	1.60x0.85x0.65	A-3
RFLPF1608060Y18Q1C	698-960	0.60(698-830MHz) 0.70(830-900MHz) 0.75(900-915MHz) 0.90(915-960MHz)	30(1554-1830MHz) 35(2097-2745MHz)	1.6	50	1.60x0.85x0.65	A-3
RFLPF2012090Y2T	400-470	0.50(25°C) 0.65(-40~+85°C)	33(800-940MHz)	2.0	50	2.00x1.25x0.90	F
RFLPF2012090Y3T	500-700	0.65(25°C) 0.80(-40~+85°C)	33(1000-1400MHz)	2.0	50	2.00x1.25x0.90	F
RFLPF2012100Y0T	DC-500	0.70	9(824-960MHz) 25(1710-1990MHz) 25(2400-4000MHz)	2.0	50	2.00x1.25x0.95	B-2
RFLPF1608060E0T	1400-2690	0.25(25°C) 0.30(-40~+85°C)	25(4905-5845MHz)	1.92	50	1.60x0.85x0.65	F
RFLPF1608060F0T	600-2700	0.50	30(4800-8000MHz) 25(8500-12500MHz)	2.0	50	1.60x0.85x0.65	F
RFLPF1608060F18Q1C	673-2690	0.50	35(4950-6000MHz) 35(6000-7500MHz) 35(7500-8100MHz) 35(8100-10500MHz) 27(10500-12500MHz)	2.0	50	1.60x0.85x0.65	F
RFLPF1608060F88Q1C	10-2700	0.5	30(4900-5950MHz)	2.0	50	1.60x0.85x0.65	E
RFLPF1608060FAT	673-2690	0.25(25°C) 0.35(-40~+85°C)	25(4905-5845MHz)	1.92	50	1.60x0.85x0.65	F
RFLPF2012100F18Q1C	1710-2170	1.30(25°C) 1.50(-40~+85°C)	15(2400-2500MHz) 25(3250-3350MHz) 25(3420-3570MHz) 23(3700-3820MHz) 23(3840-3960MHz) 23(4100-4600MHz) 25(4905-5845MHz) 23(5850-6400MHz) 20(6600-7350MHz)	1.56	50	2.00x1.25x1.00	B-2
RFLPF2012100F28Q1C	DC-2170	0.75(25°C) 0.85(-40~+85°C)	10(2400-2500MHz) 23(3250-3350MHz) 20(3420-3570MHz) 18(3700-3820MHz) 18(3840-3960MHz) 18(4100-4600MHz) 20(4905-5845MHz) 18(5850-6400MHz) 5(6600-7350MHz)	2.0	50	2.00x1.25x1.00	F
RFLPF16082G6W0T	2400-2690	0.6	26(4800-5390MHz) 23(7200-8085MHz)	2.0	50	1.60x0.80x0.60	A-2
RFLPF16082G6W2T	2300-2700	0.40(25°C) 0.43(-40~+85°C)	21(4600-5400MHz) 22(6900-8100MHz)	2.0	50	1.60x0.80x0.60	A-2
RFLPF16082G5W0T	2300-2700	0.90(25°C) 1.00(-40~+85°C)	30(4600-5400MHz) 30(6900-8100MHz) 20(9200-10800MHz) 15(11500-13500MHz)	1.8	50	1.60x0.80x0.60	A-1
RFLPF16082G5WM0T29	2300-2690	0.80 (typ.0.40)	25(4600-5400MHz) 25(6900-8070MHz)	2.0	50	1.60x0.80x0.60	A-1
RFLPF16083G5W7T	3300-3800	0.55	17(6600-7600MHz) 20(9900-11400MHz)	1.9	50	1.60x0.80x0.60	A-3
RFLPF2012090BM0T29	800-1000 1700-1910 2010-2025	0.5(800-1000MHz) 0.8(1700-1910MHz) 1.5(2010-2025MHz)	20(2300-3700MHz) 30(3700-4100MHz) 20(4100-6100MHz) 10(6100-8000MHz)	2.0	50	2.00x1.25x0.90	F

MoCA APPLICATION

Part Number	Frequency Range (MHz)	Insertion Loss (dB)	Attenuation (dB min.)	VSWR (max.)	Impedance (Ω)	Size(mm)	Structure
RFLPF3225180Y1T	54-870	2.5	35(975-1675MHz)	2.0	75	3.20x2.50x1.80	H
RFLPF3225100Q07B1U	5-1002	2.4(25°C) 2.6(-40~+85°C)	36(1125-1675MHz)	2.0	75	3.20x2.50x1.00	H
RFLPF3225100Q2T	5-1002	2.4(25°C) 2.6(-40~+85°C)	28(1125-1675MHz)	1.9	75	3.20x2.50x1.00	B-1
RFLPF3225200Q5T	5-1002	1.8(25°C) 2.05(-40~+85°C)	33(1125-1400MHz) 26(1400-1675MHz)	2.0	75	3.20x2.50x1.80	H

■ **TYPICAL ELECTRICAL CHARACTERISTICS**

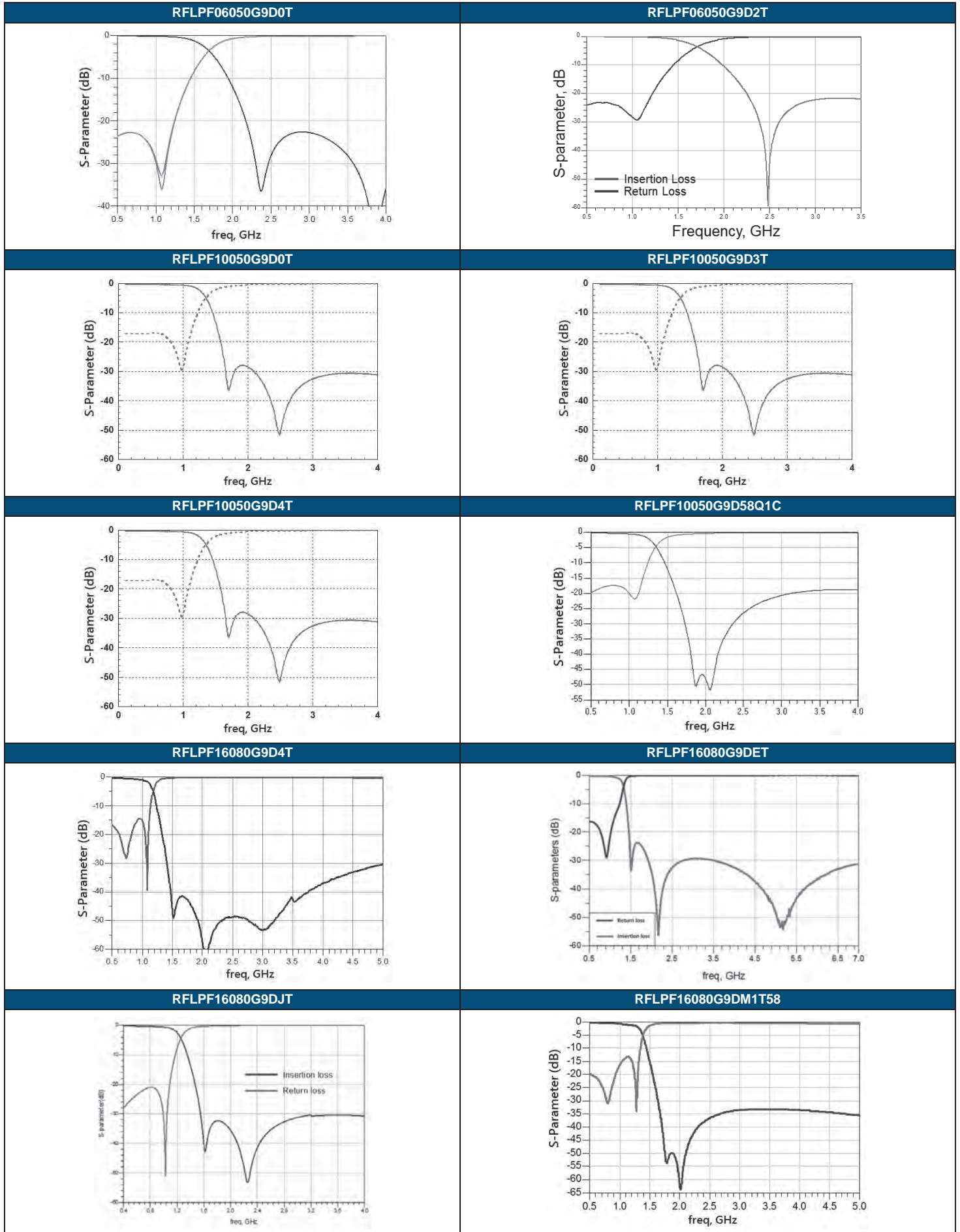

TYPICAL ELECTRICAL CHARACTERISTICS

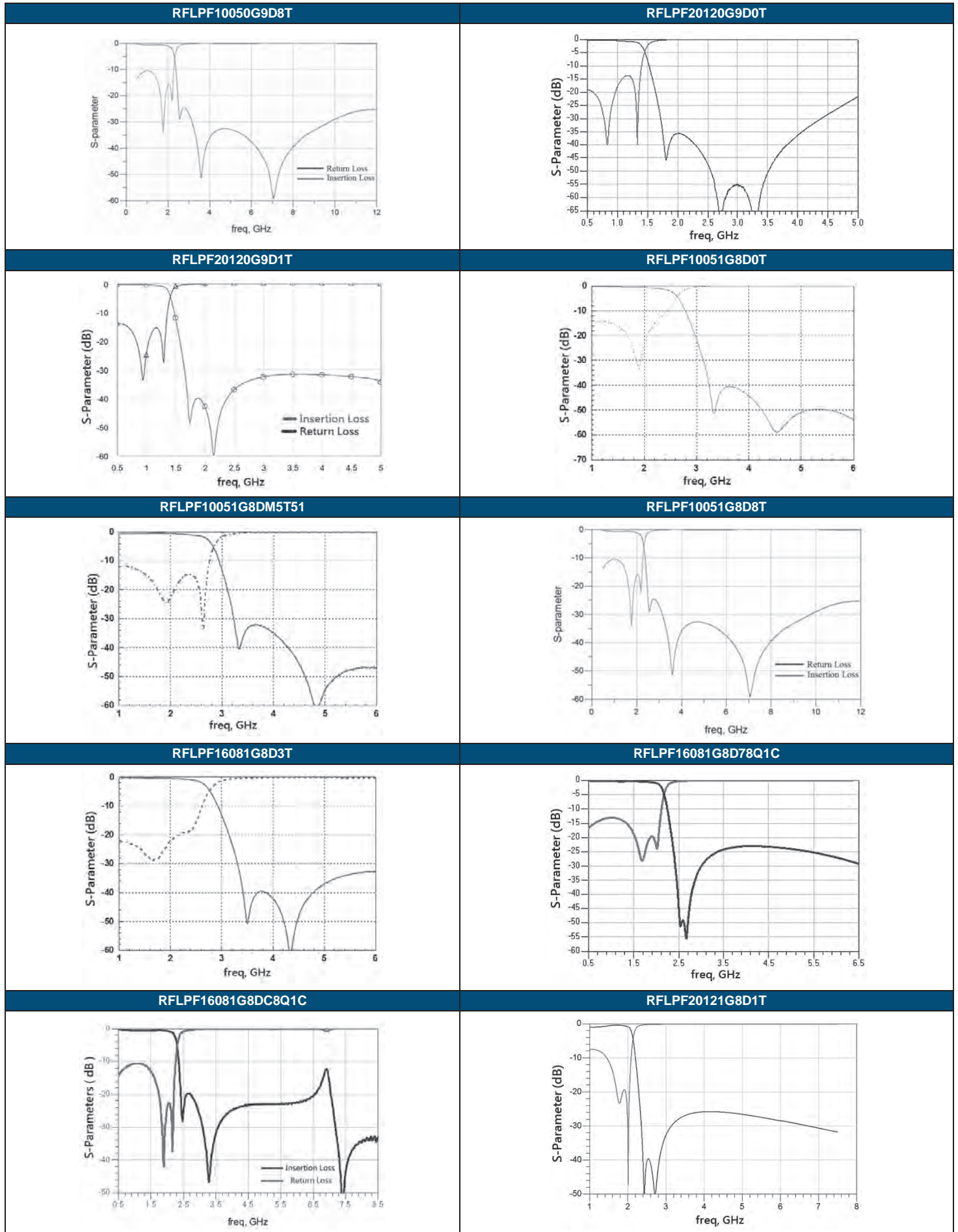

TYPICAL ELECTRICAL CHARACTERISTICS

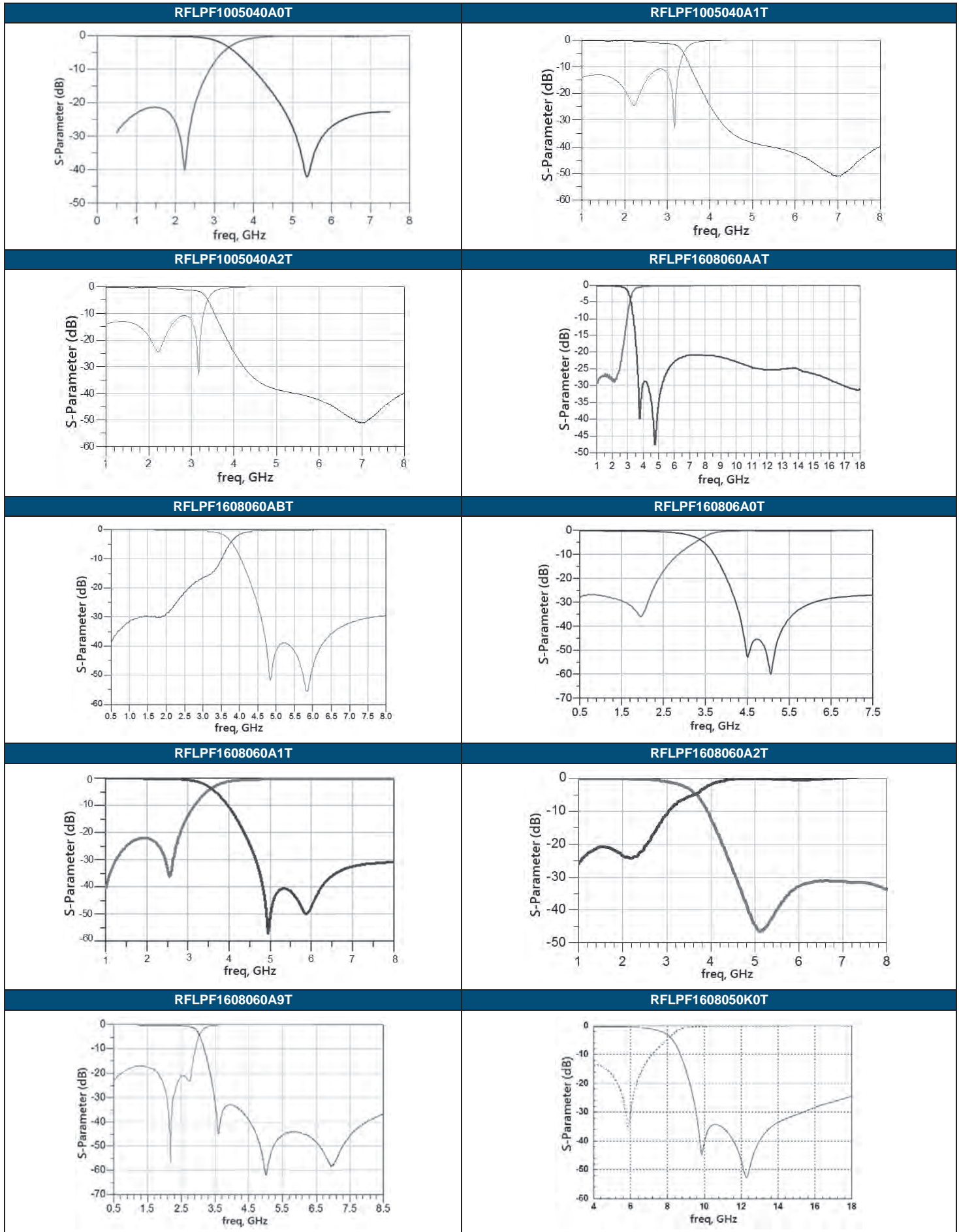

TYPICAL ELECTRICAL CHARACTERISTICS

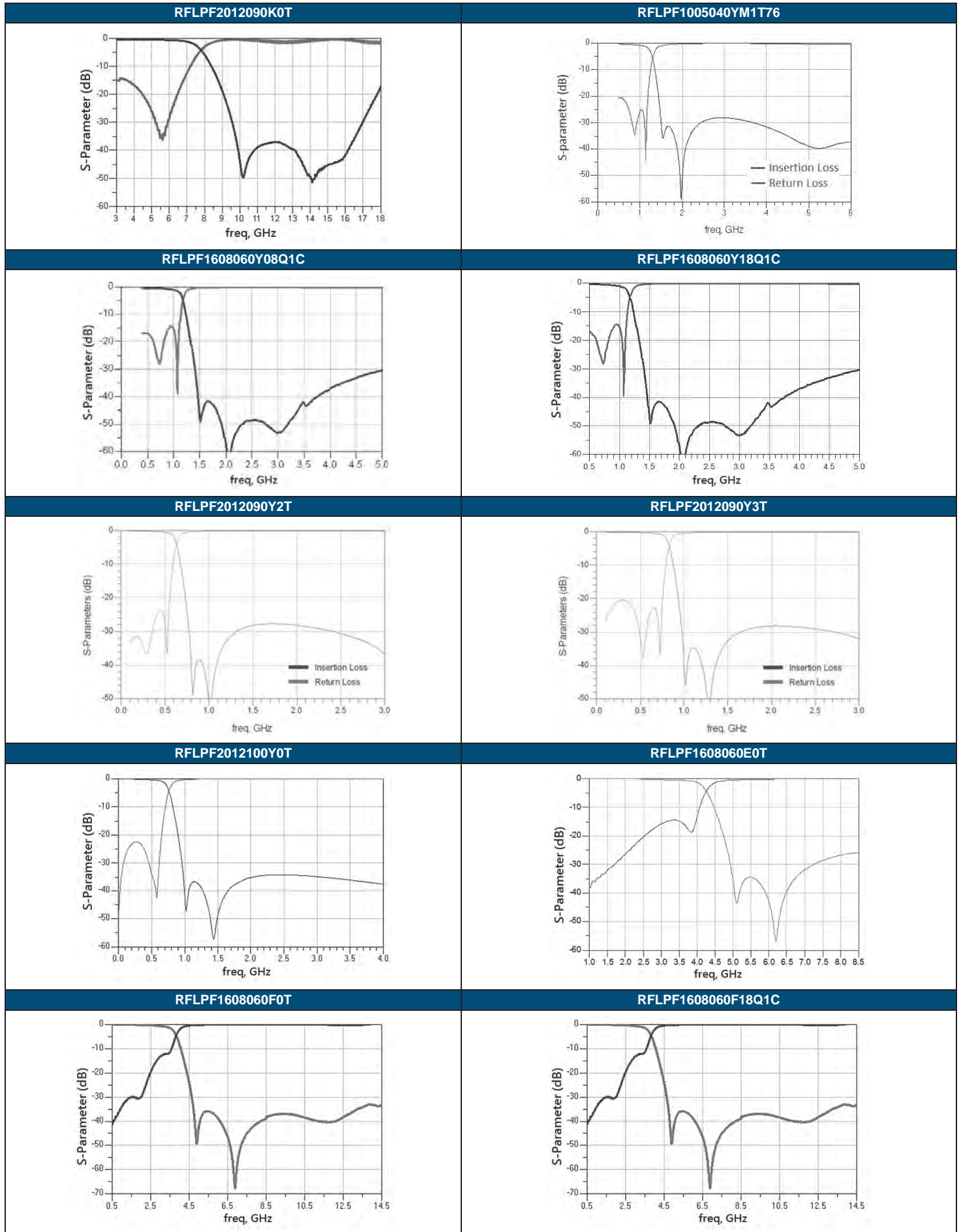

TYPICAL ELECTRICAL CHARACTERISTICS

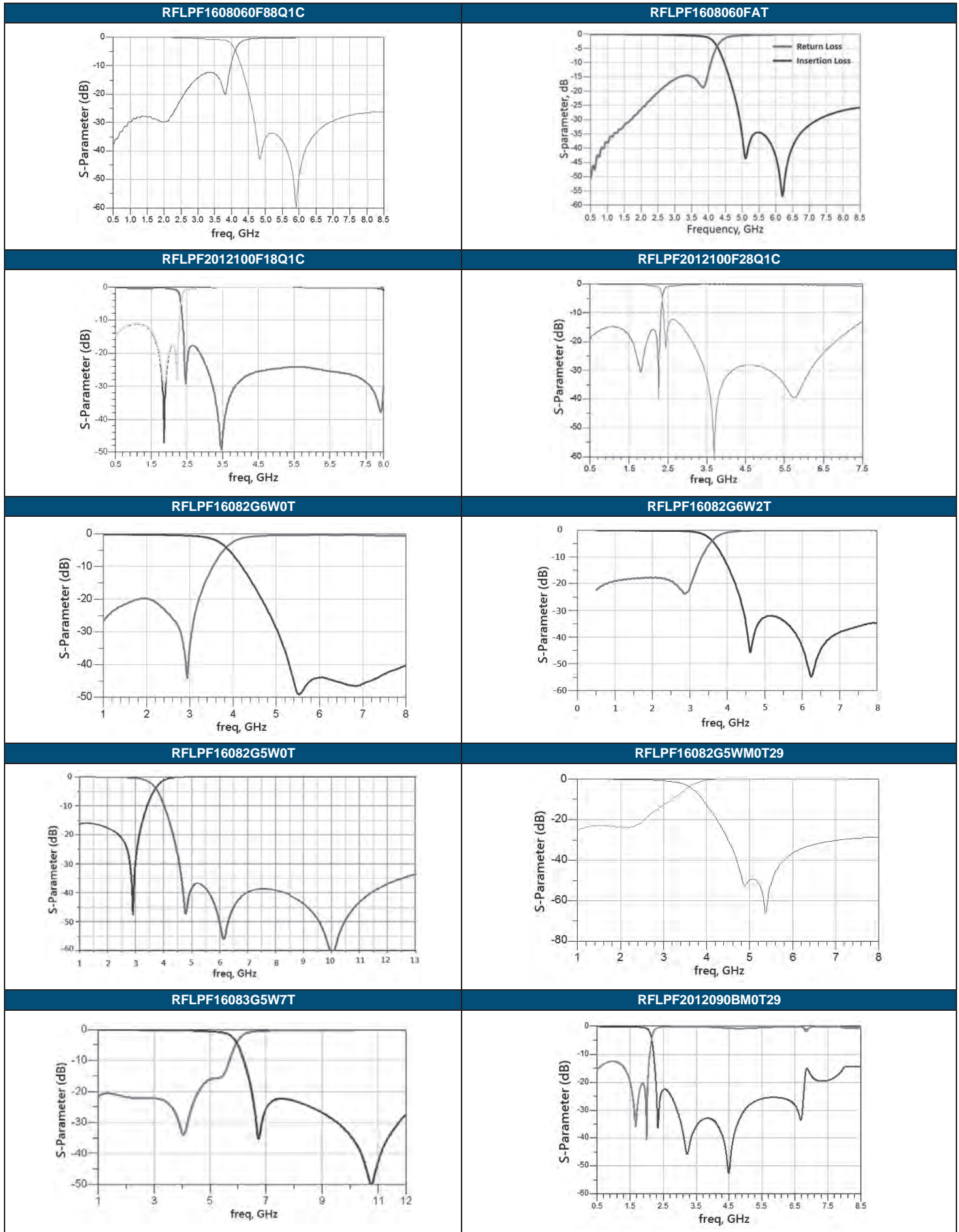

TYPICAL ELECTRICAL CHARACTERISTICS

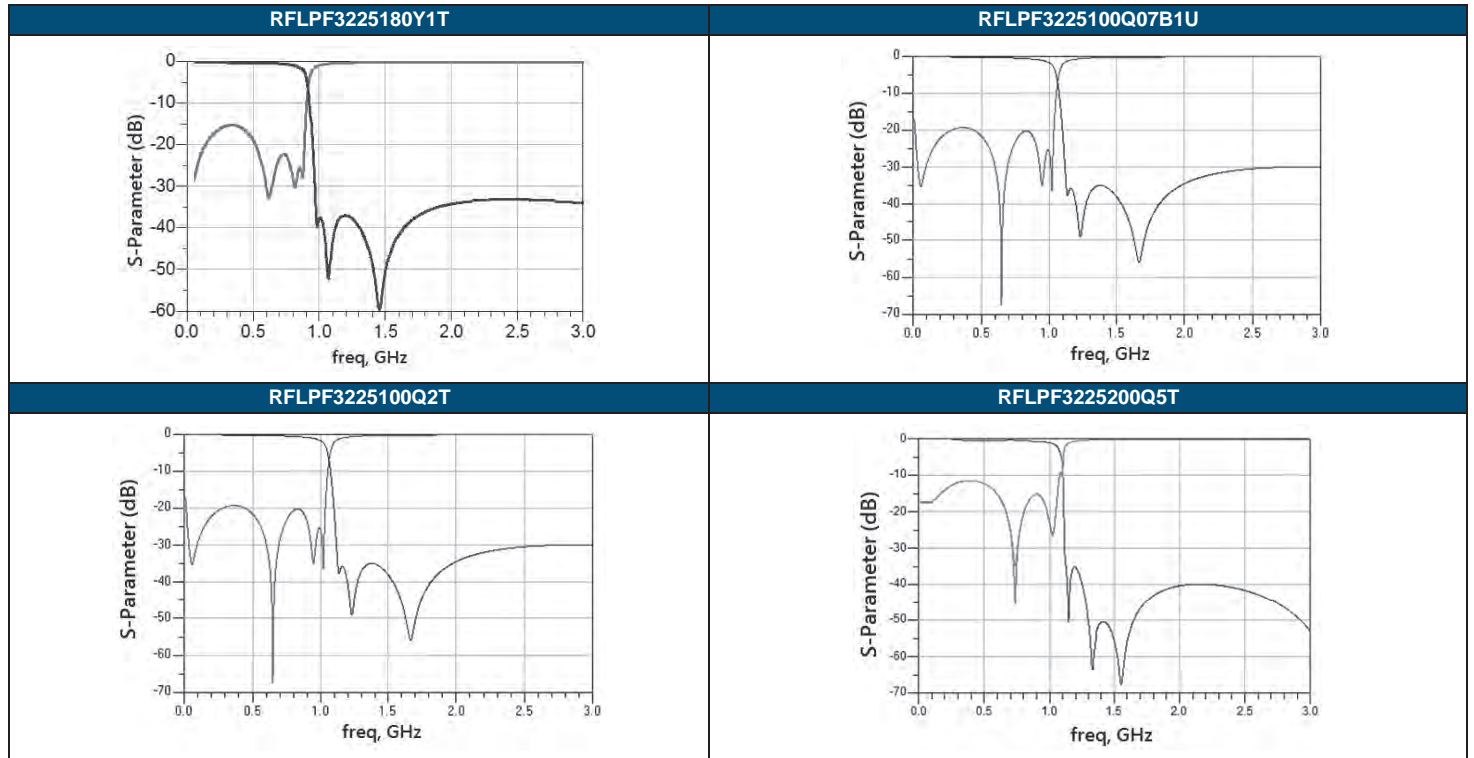

- For more information, please contact with local sales representative
- All specifications are subject to change without notice

HIGH FREQUENCY MULTILAYER HIGH PASS FILTER

■ **STRUCTURE AND PIN ASSOCIATED**

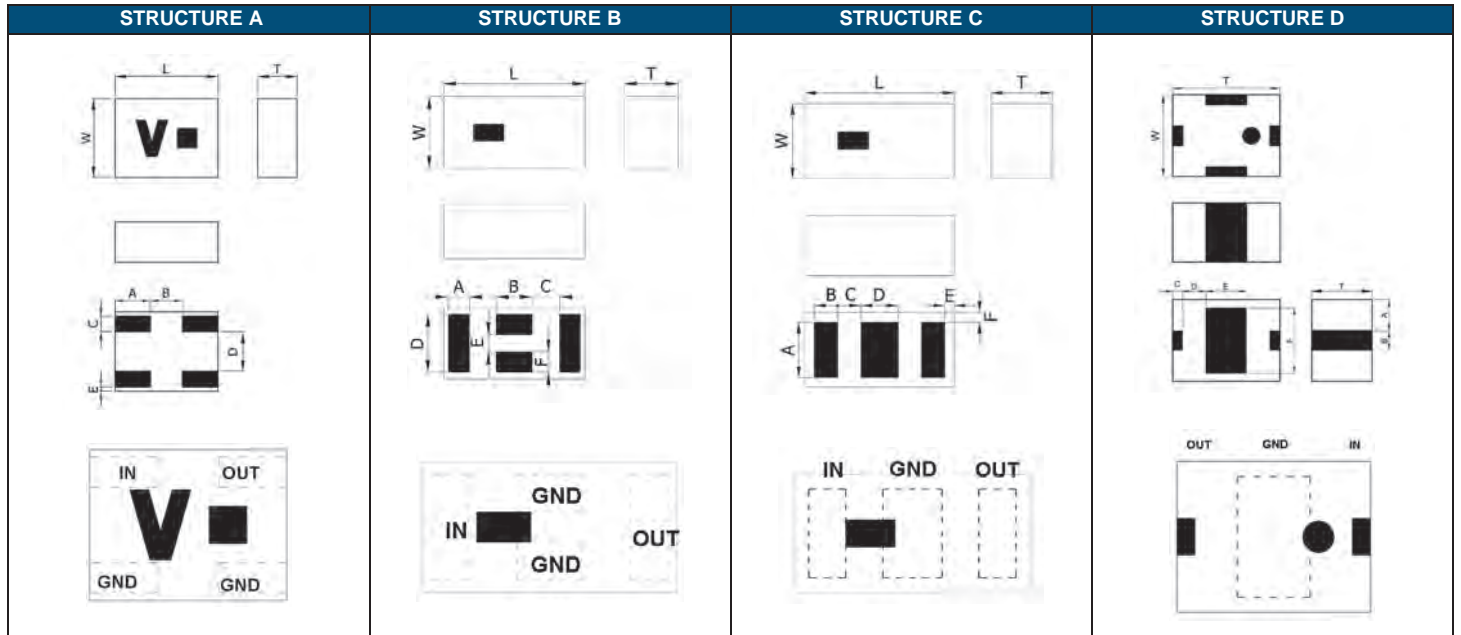

■ **STRUCTURE AND DIMENSION**

Unit: mm

Structure/Dimension	L	W	T	A	B	C	D	E	F
A	0.65 ± 0.10	0.50 ± 0.10	0.4 max.	0.225 ± 0.10	0.20 ± 0.05	0.10 ± 0.10	0.20 ± 0.05	0.05 ± 0.05	-
B	1.60 ± 0.15	0.80 ± 0.15	0.60 ± 0.1.0	0.23 ± 0.05	0.40 ± 0.10	0.30 ± 0.10	0.65 ± 0.10	0.20 ± 0.05	0.23 ± 0.05
C	1.60 ± 0.10	0.80 ± 0.10	0.65 max.	0.65 ± 0.10	0.25 ± 0.10	0.275 ± 0.10	0.40 ± 0.10	0.075 ± 0.05	0.075 ± 0.05
D	3.20 ± 0.20	2.50 ± 0.20	1.7 max.	0.95 ± 0.20	0.60 ± 0.20	0.30 ± 0.15	0.70 ± 0.15	1.20 ± 0.15	2.00 ± 0.15

■ **ELECTRICAL SPECIFICATION**

2496 ~ 2690 MHz BAND WORKING FREQUENCY

Part Number	Frequency Range (MHz)	Insertion Loss (dB)	Attenuation (dB min.)	VSWR (max.)	Size (mm)	Structure
RFHPPF16082G5W0T	2496-2690	1.2max.(25°C) 1.3max.(-40~+85°C)	25(1710-1995MHz)	2.0	1.6 X 0.8 X 0.6	B
RFHPPF16082G5W1T	2496-2690	0.9max.(25°C) 1.2max.(-40~+85°C)	22(1710-2010MHz)	2.0	1.6 X 0.8 X 0.6	C

5GHZ BAND WORKING FREQUENCY

Part Number	Frequency Range (MHz)	Insertion Loss (dB)	Attenuation (dB min.)	VSWR (max.)	Size (mm)	Structure
RFHPPF0605040K0T	4900-5840	0.60max.(25°C) 0.65max.(-40~+85°C)	14(2400-2500MHz)	1.6	0.65 X 0.5 X 0.4	A
RFHPPF0605040K1T	4900-5850	0.65	20(2450-2500MHz)	2.0	0.65 X 0.5 X 0.4	A

MoCA Application

Part Number	Frequency Range (MHz)	Insertion Loss (dB)	Attenuation (dB min.)	VSWR (max.)	Size (mm)	Structure
RFHPPF3225170F07B1U	950-2150	2.00max.(25°C) 2.2max.(-40~+85°C)	50(475-675MHz)	2.0	3.2 X 2.5 X 1.7	D

■ **TYPICAL ELECTRICAL CHARACTERISTICS**

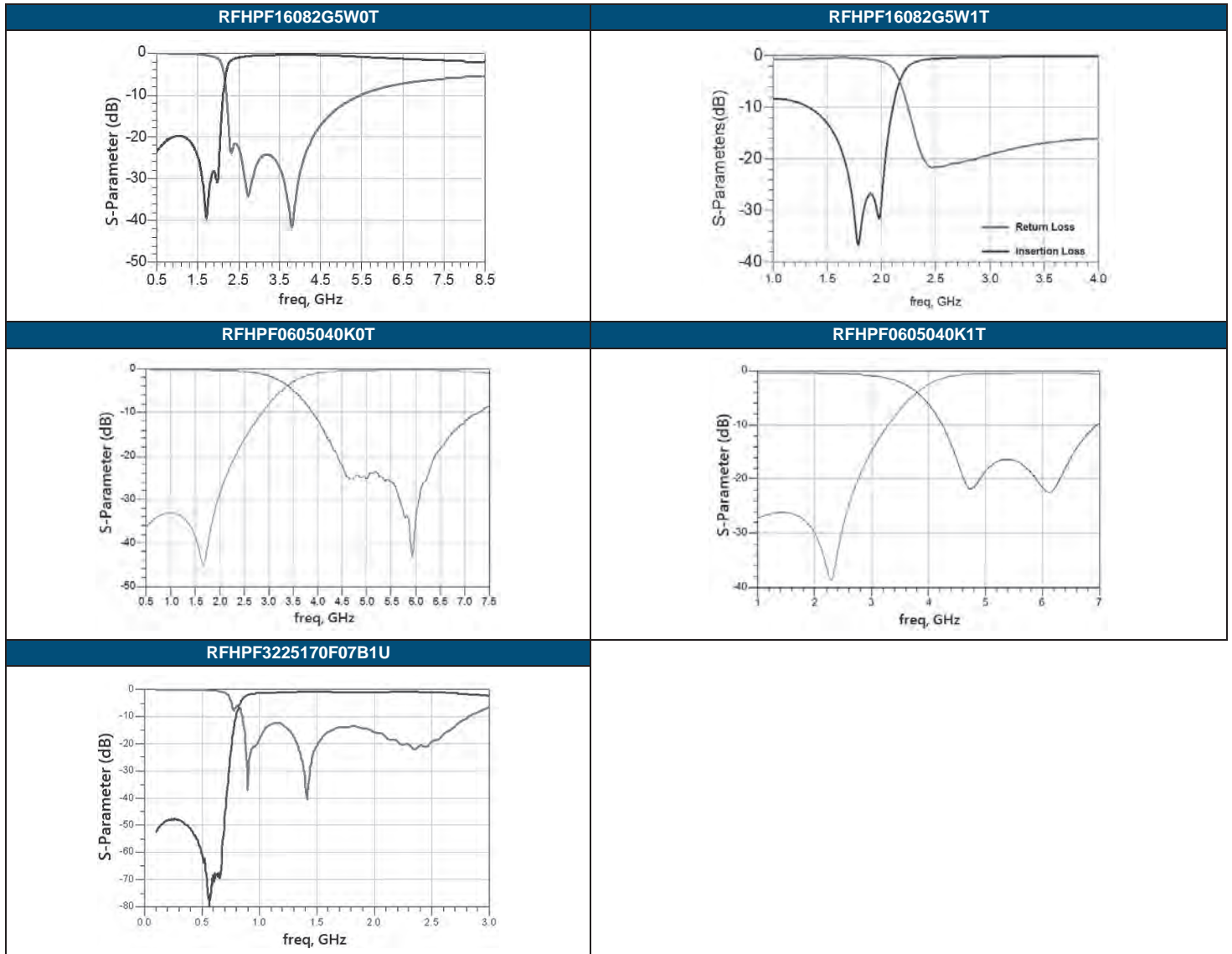

- For more information, please contact with local sales representative
- All specifications are subject to change without notice

BALUN TRANSFORMERS

■ **STRUCTURE AND PIN ASSOCIATED**

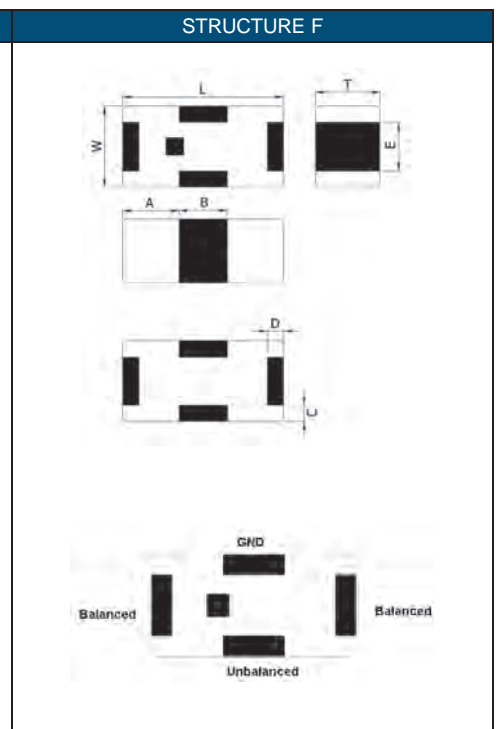
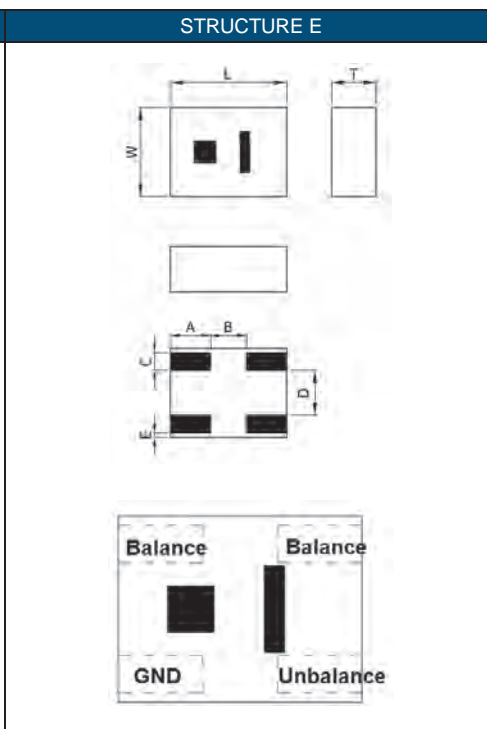
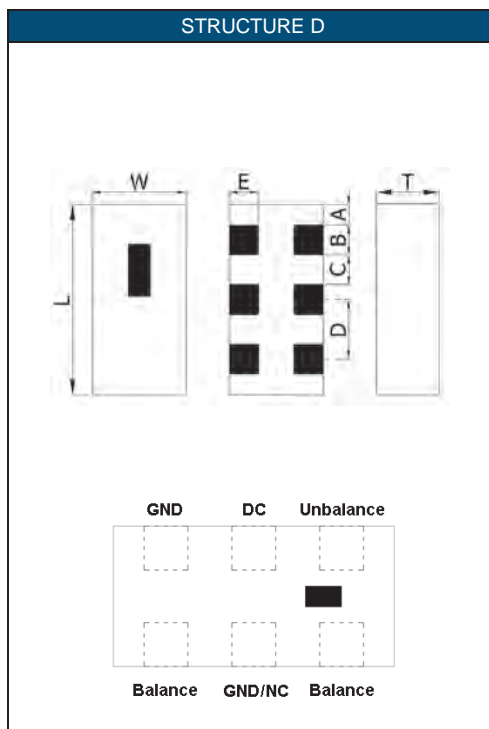
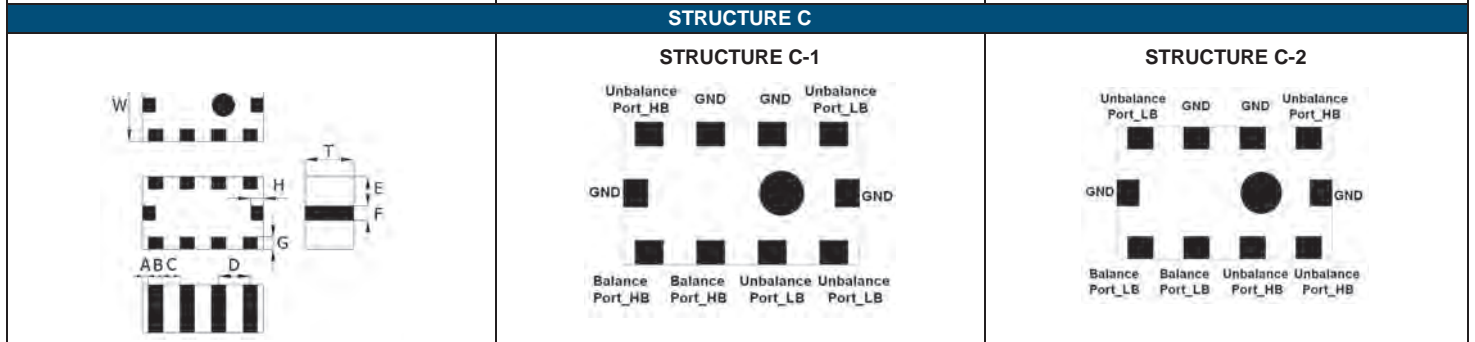
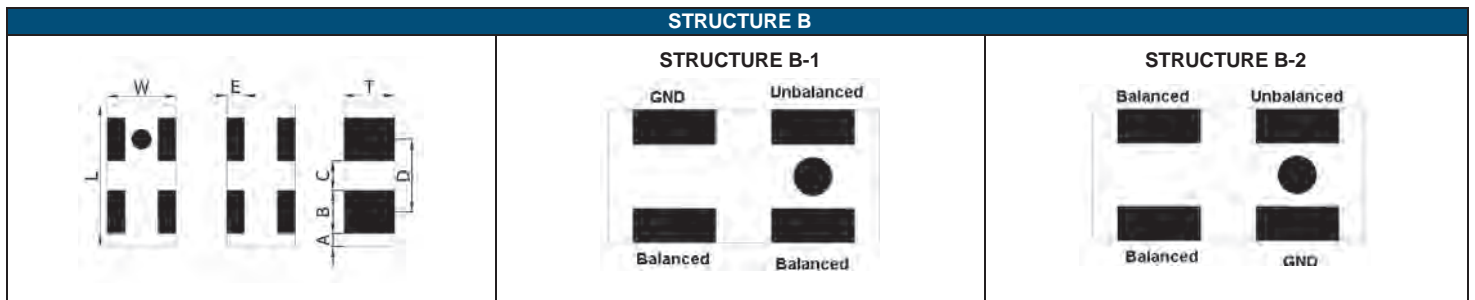
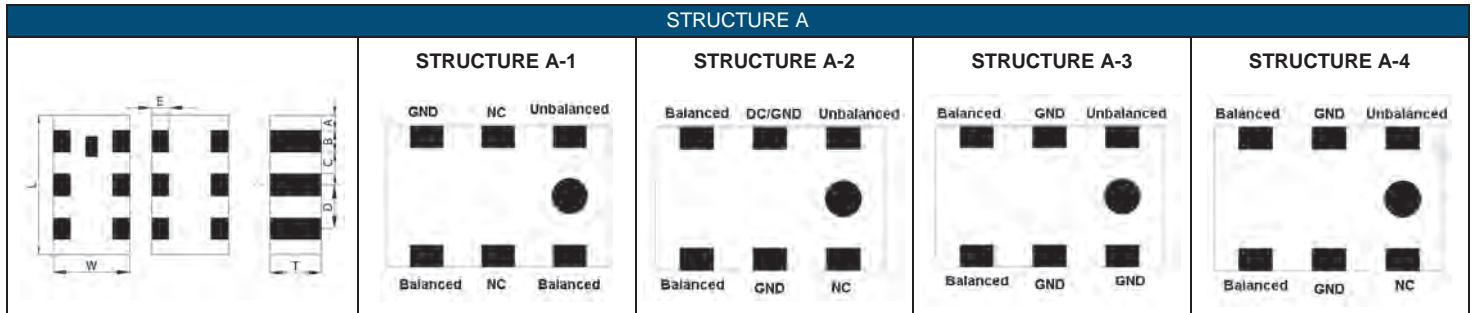

■ **STRUCTURE AND DIMENSION**

Unit: mm

Structure/Dimension	L	W	T	A	B	C	D	E	F	G	H
A	1.60±0.10	0.85±0.10	0.70±0.10	0.20±0.10	0.20±0.10	0.30±0.10	0.50±0.05	0.50±0.05	-	-	-
	1.60±0.15	0.80±0.10	0.50±0.10	0.175±0.15	0.25±0.15	0.25±0.15	0.50±0.15	0.20±0.15	-	-	-
			0.85±0.10	0.40 max.	0.175±0.15	0.25±0.15	0.25±0.15	0.50±0.15	0.20±0.15	-	-
		0.85±0.15	0.60±0.10	0.175±0.15	0.25±0.15	0.25±0.15	0.50±0.15	0.20±0.15	-	-	-
			0.70±0.10	0.175±0.15	0.25±0.15	0.25±0.15	0.50±0.15	-	-	-	-
	0.65±0.10	-	-					-	-	-	
	2.00±0.15	1.25±0.15	0.80±0.10	0.20±0.20	0.30±0.20	0.35±0.20	0.65±0.20	-	-	-	-
			0.85±0.10	0.20±0.20	0.30±0.20	0.35±0.20	0.65±0.20	-	-	-	-
			0.80±0.10	0.20±0.15	0.30±0.20	0.35±0.20	0.65±0.20	-	-	-	-
			0.95±0.10	0.20±0.20	0.30±0.20	0.35±0.20	0.65±0.20	-	-	-	-
B	1.00±0.10	0.50±0.10	0.37±0.10	0.10±0.10	0.30±0.10	0.20±0.10	0.50±0.10	0.125±0.10	-	-	-
	1.00±0.10	0.50±0.10	0.40±0.10	0.10±0.10	0.30±0.10	0.20±0.10	0.50±0.10	0.125±0.10	-	-	-
C	2.00±0.10	1.25±0.15	0.90±0.10	0.125±0.10	0.25±0.10	0.25±0.10	0.50±0.10	0.475±0.10	0.30±0.10	0.20±0.15	0.20±0.15
D	1.60±0.15	0.80±0.15	0.50±0.10	0.175±0.10	0.25±0.10	0.25±0.10	0.50±0.10	0.25±0.10	-	-	-
E	0.65±0.10	0.50±0.10	0.40±0.10	0.20±0.05	0.20±0.05	0.025±0.025	0.10±0.05	0.25±0.05	0.025±0.025	-	-
F	1.00±0.10	0.50±0.10	0.5 max.	0.35±0.10	0.30±0.10	0.15±0.10	0.15±0.10	0.30±0.10	-	-	-

■ **ELECTRICAL SPECIFICATION**

ISM Band 2.4GHz APPLICATION

Part Number	Frequency Range (MHz)	Impedance(Ω)		Return Loss (dB) Min.	Insertion Loss (dB)	Amplitude Difference (dB) Max.	Phase Difference	Size(mm)	Structure
		Unbalance	Balance						
RFBLN1005040A6T	2400~2500	50	50	10	0.8	2.0	180± 10	1.00x0.50x0.40	B-2
RFBLN1608050AAT	2400~2500	50	Conjugate match to AR6003 chipset	10	1.2	2.0	180± 10	1.60x0.80x0.50	D
RFBLN1608050AM8T62	2400~2500	50	50	10	1.2	2.0	180± 10	1.60x0.80x0.50	A-2
RFBLN1608050AM0T63	2400~2500	50	50	10	1.0	1.0	180± 10	1.60x0.80x0.55	A-2
RFBLN1608050AM6T30	2400~2500	50	35	10	1.0	1.0	180± 10	1.60x0.80x0.55	A-2
RFBLN1608060AC6T40	2400~2500	50	Conjugate match to TI CC26XX Chipset	10	1.6(25°C) 1.8(-40~+85°C)	2.3	180± 18	1.60x0.80x0.60	A-3
RGBLN1608070A1T	2400~2500	50	100	10	1.5	2.0	180± 15	1.60x0.85x0.70	A-1
RGBLN1608070A5T	2400~2500	50	100	10	1.2	2.0	180± 10	1.60x0.80x0.70	A-2
RGBLN2012080A5T	2400~2500	50	50	12	1.0	1.0	180± 10	2.00x1.25x0.85	A-2
RFBLN2012080A7T	2400~2500	50	100	10	1.0	2.0	180± 10	2.00x1.25x0.80	A-2
RGBLN2012090A0T	2400~2500	50	50	10	1.2	2.0	180± 10	2.00x1.25x0.95	A-2
RFBLN2012090A1T	2400~2500	50	100	10	1.0	2.0	180± 10	2.00x1.25x0.95	A-2

ISM Band 5GHz APPLICATION

Part Number	Frequency Range (MHz)	Impedance(Ω)		Return Loss (dB) Min	Insertion Loss (dB)	Amplitude Difference (dB) Max.	Phase Difference	Size (mm)	Structure
		Unbalance	Balance						
RFBLN1005040K1T	4900~5950	50	50	10	1.2	2.0	180± 10	1.00x0.50x0.40	B-2
RFBLN1005040K5T	4900~5950	50	100	10	0.55(25°C) 0.75(-40~+85°C)	2.5	180± 10	1.00x0.50x0.40	B-2
RFBLN1005040K6T	4900~5950	50	50	10	0.60(25°C) 0.80(-40~+85°C)	2.5	180± 15	1.00x0.50x0.40	B-2
RFBLN2012090K1T	4900~5900	50	100	10	1.2	2.0	180± 10	2.00x1.25x0.95	A-4

LTE Band APPLICATION

Part Number	Frequency Range (MHz)	Impedance(Ω)		Return Loss (dB)Min	Insertion Loss (dB)	Amplitude Difference (dB) Max.	Phase Difference	Size (mm)	Structure
		Unbalance	Balance						
RFBLN0605040Y1T	717-821	50	100	15	0.55(25°C) 0.65(-40~+85°C)	2.0	180± 10	0.65x0.50x0.40	E
RFBLN0605040YM9T16	729-821	50	100	10	0.55(25°C) 0.65(-40~+85°C)	2.0	180± 10	0.65x0.50x0.40	E
RFBLN1005040YM1T69	703-803	50	100	10	0.8	2.0	180± 12	1.00x0.50x0.40	F
RFBLN06050G9D0T	729-960	50	100	15	0.85(25°C) 0.95(-40~+85°C)	4.8	180± 10	0.65x0.50x0.40	E
RFBLN16080G9D2T	699-960	50	100	10	1.05(25°C) 1.15(-40~+85°C)	2.5	180± 15	1.60x0.80x0.70	A-4
RFBLN16080G9D3T	824-894	50	50	10	1.2	1.0	180± 10	1.60x0.80x0.60	A-2
RFBLN20120G9D0T	824-894	50	100	10	1.2	1.0	180± 10	2.00x1.25x0.90	A-2
RFBLN20120G9D5T	880-960	50	100	10	1.1	1.0	180± 10	2.00x1.25x0.90	A-2
RFBLN20120G9D8T	800-1000	50	50	10	1.2	2.0	180± 10	2.00x1.25x0.90	A-2
RFBLN06051G8DM1T69	1805-1990	50	100	10	0.60(25°C) 0.65(-40~+85°C)	1.8	180± 10	0.65x0.50x0.40	E
RFBLN06051G8D1T	1805-2170	50	100	10	0.65(25°C) 0.70(-40~+85°C)	3.0	180± 15	0.65x0.50x0.40	E
RFBLN20121G8D1T	1700-2000	50	100	10	1.0	2.0	180± 10	2.00x1.25x0.95	A-2
RFBLN10051G9D0T	1805-2020	50	100	10	0.65(25°C) 0.75(-40~+85°C)	2.0	180± 10	1.00x0.50x0.40	B-2
RFBLN10051G9D1T	1805-1990	50	100	10	0.60(25°C) 0.70(-40~+85°C)	2.2	180± 12	1.00x0.50x0.40	B-2
RFBLN1005040F0T	1805-2170	50	100	10	0.70(25°C) 0.80(-40~+85°C)	1.2	180± 15	1.00x0.50x0.40	F
RFBLN1608070F48Q1C	673-2700	50	100	10	1.7(25°C) 2.0(-40~+85°C)	1.5	180± 17	1.60x0.80x0.70	A-4
RFBLN1608060FET	1710-2200	50	50	10	1.20(25°C) 1.40(-40~+85°C)	2.0	180± 10	1.60x0.80x0.60	A-2
RFBLN2012090F0T	1920-1980 2110-2170	50	50	10	1.0	2.0	180± 10	2.00x1.25x0.95	A-2
RFBLN0605040E0T	2000-2500	50	100	10	0.60(25°C) 0.70(-40~+85°C)	3.5	180± 10	0.65x0.50x0.40	E
RFBLN2012090E0T	1500-3000	50	100	10	1.0	2.0	180± 10	2.00x1.25x0.90	A-4
RFBLN06052G5W9T16	2300-2690	50	100	10	0.55(25°C) 0.65(-40~+85°C)	2.5	180± 10	0.65x0.50x0.40	E
RFBLN10052G5W9T16	2300-2690	50	100	10	0.55(25°C) 0.65(-40~+85°C)	2.5	180± 10	1.00x0.50x0.40	B-1
RFBLN10052G5W37N2T	2300-2690	50	100	10	0.65(25°C) 0.75(-40~+85°C)	2.5	180± 10	1.00x0.50x0.40	B-2
RFBLN16082G5W0T	2300-2700	50	100	10	1.1	2.0	180± 10	1.60x0.80x0.70	A-2
RFBLN16082G5W38Q1C	2300-2700	50	100	10	0.55(25°C) 0.65(-40~+85°C)	1.0	180± 10	1.60x0.80x0.40	A-4
RFBLN16082G5W4T	2300-2700	50	50	10	1.2	2.0	180± 10	1.60x0.80x0.50	A-2

GSM 850/ GSM 900/ DCS1800/ PCS1900 APPLICATION

Part Number	Frequency Range (MHz)	Unbalance	Balance	Return Loss (dB) Min	Insertion Loss (dB)	Amplitude Difference (dB) Max	Attenuation (dB min.)	Phase Difference	Size(mm)	Structure
RFBLN2012090BM5T25	869-960	50	200	10	1.1	2.0	10(1738-1920MHz) 20(2400-2500MHz) 20(2607-2880MHz)	180± 10	2.00x1.25x0.95	C-1
	1805-2025	50	200	10	1.8	2.0	15(2400-2500MHz) 20(3610-3980MHz) 20(5415-5970MHz)	180± 15		
RFBLN2012090BS0T53	869-960	50	200	10	1.1(25°C) 1.3(-40~+85°C)	2.0	10(1738-1920MHz) 20(2400-2500MHz) 20(2607-2880MHz)	180± 15	2.00x1.25x0.95	C-1
	1805-1990	50	200	10	1.6(25°C) 1.8(-40~+85°C)	2.0	15(2400-2500MHz) 15(3610-3980MHz) 20(5415-5970MHz)	180± 15		
RFBLN2012090BS0T50	869-960	50	200	10	1.1(25°C) 1.3(-40~+85°C)	2.0	10(1738-1920MHz) 20(2400-2500MHz) 20(2607-2880MHz)	180± 15	2.00x1.25x0.95	C-2
	1805-2025	50	200	10	1.8(25°C) 2.0(-40~+85°C)	2.0	15(2400-2500MHz) 15(3610-3980MHz) 20(5415-5970MHz)	180± 15		

■ **TYPICAL ELECTRICAL CHARACTERISTICS**

RFBLN1005040A6T

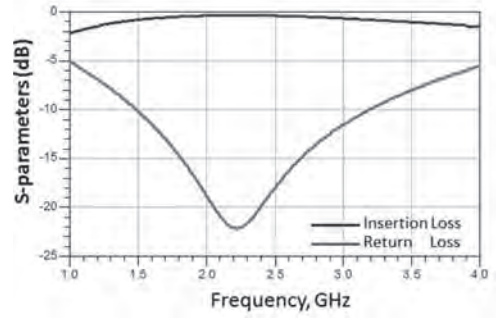
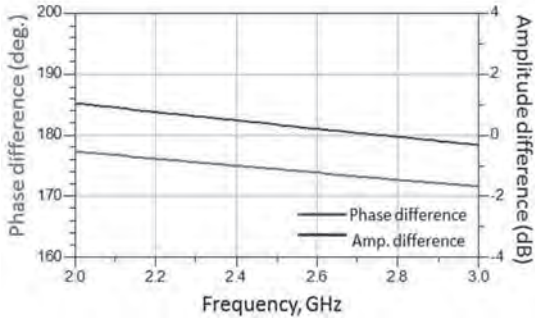

RFBLN1608050AAT

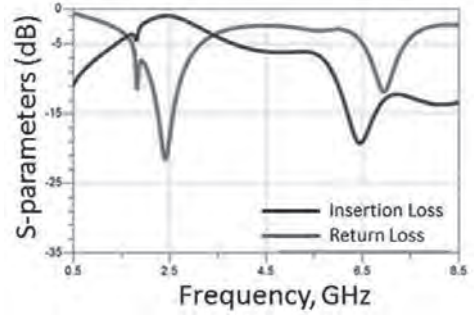
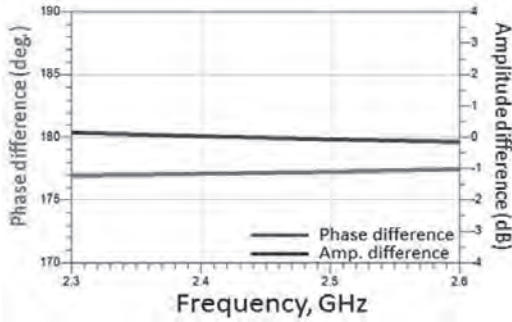

RFBLN1608050AM8T62

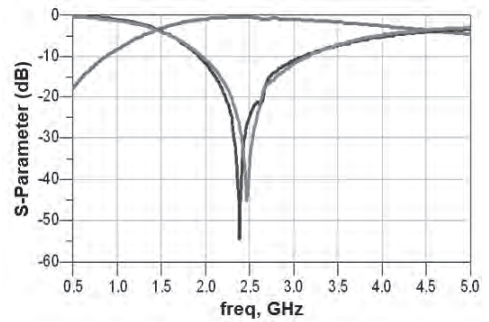
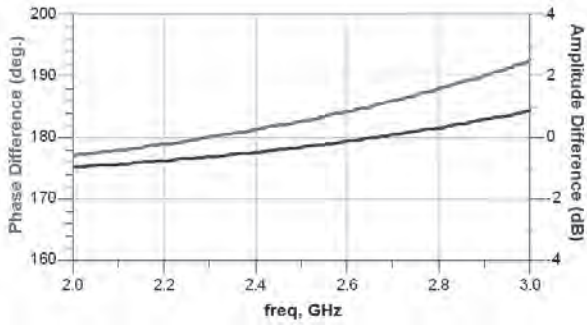

RFBLN1608050AM0T63

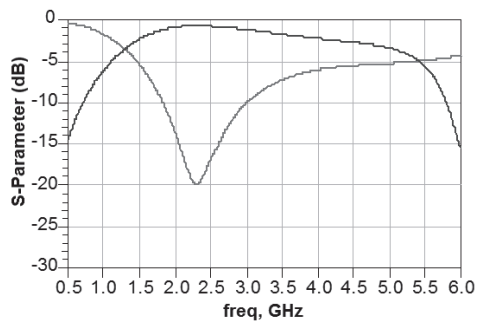
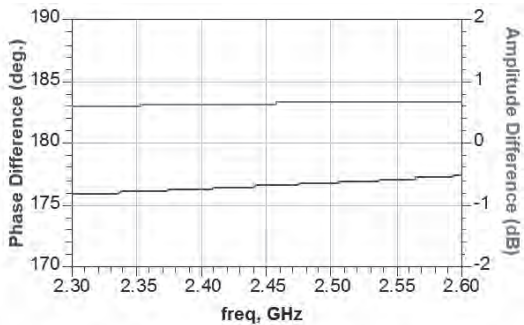

RFBLN2012080A7T

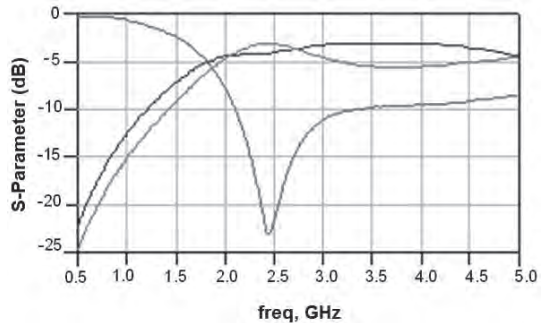
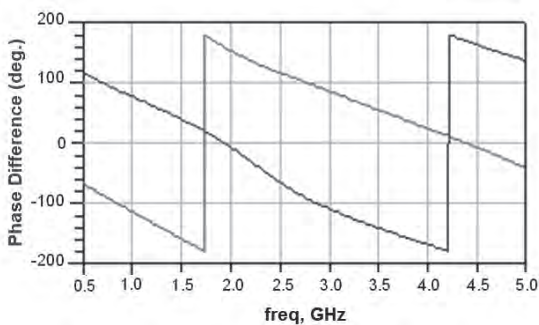

TYPICAL ELECTRICAL CHARACTERISTICS

RGBLN2012090A0T

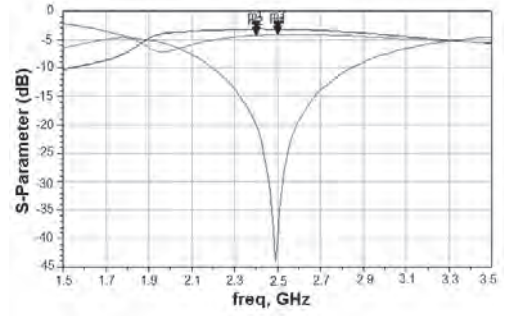
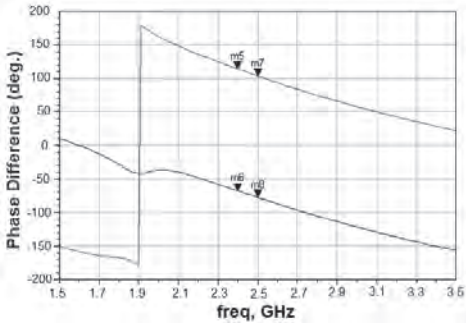

RFBLN1005040K1T

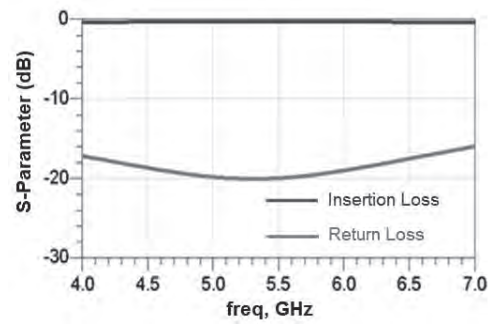
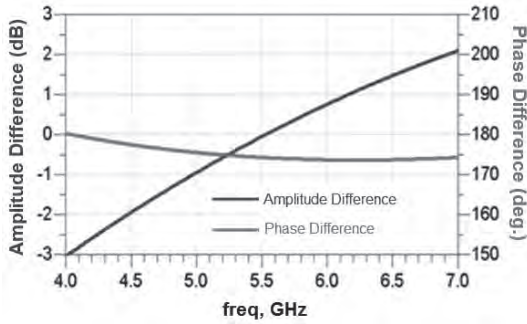

RFBLN1005040K5T

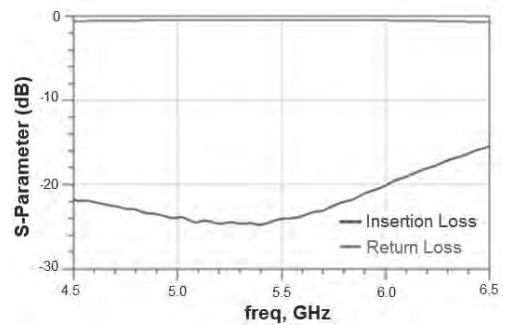
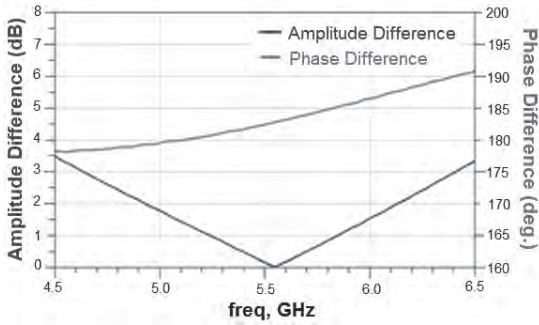

RFBLN0605040Y1T

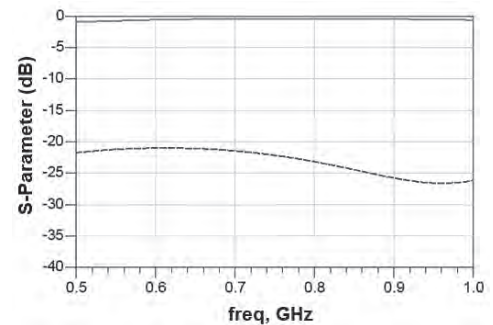
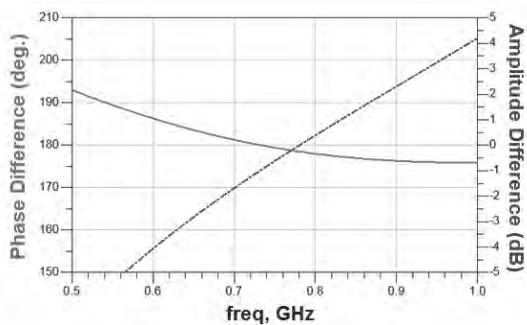

RFBLN0605040YM9T16

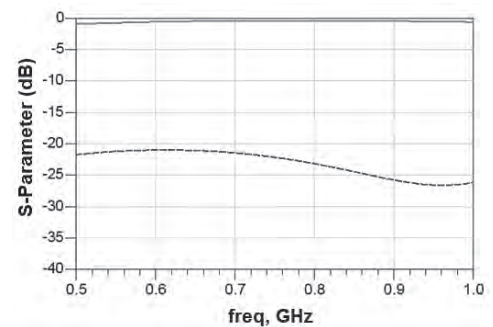
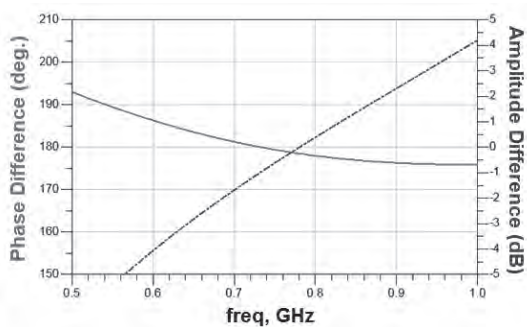

TYPICAL ELECTRICAL CHARACTERISTICS

RFBLN1005040YM1T69

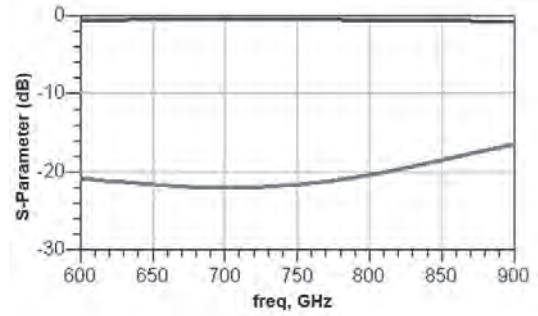
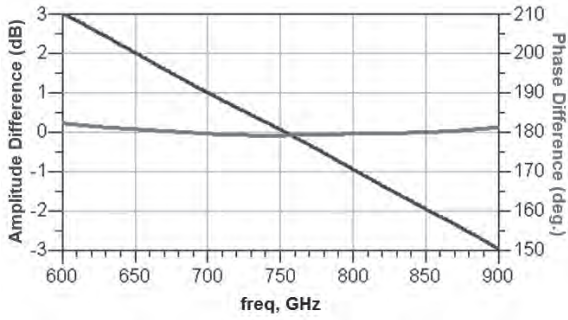

RFBLN06050G9D0T

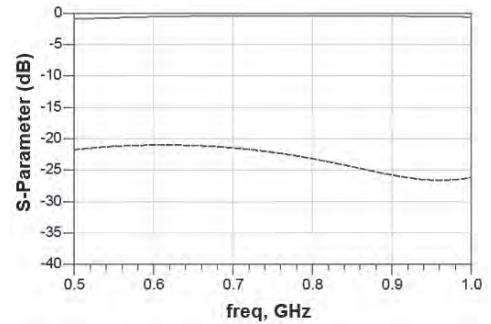
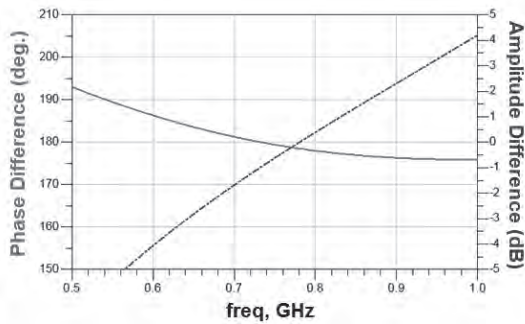

RFBLN16080G9D2T

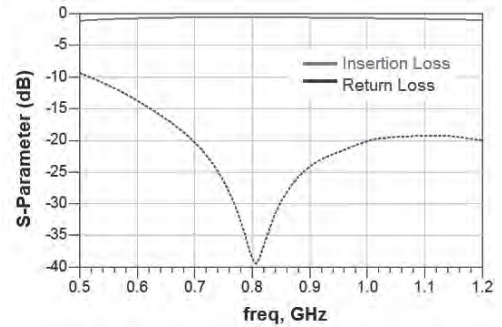
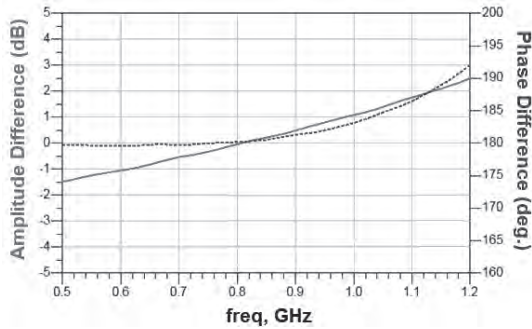

RFBLN16080G9D3T

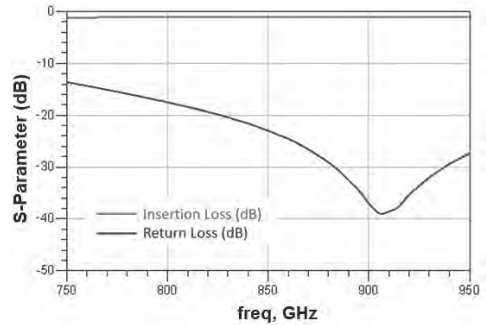
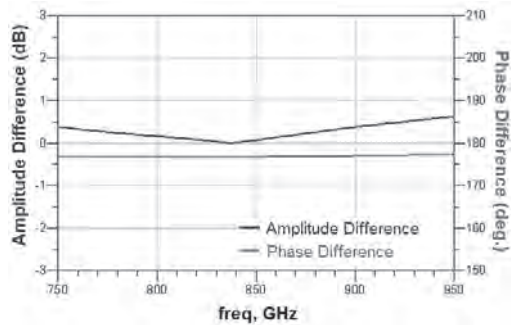

RFBLN20120G9D0T

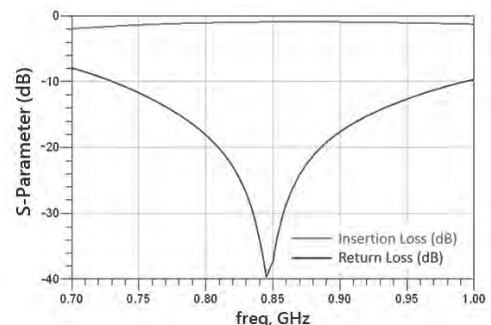
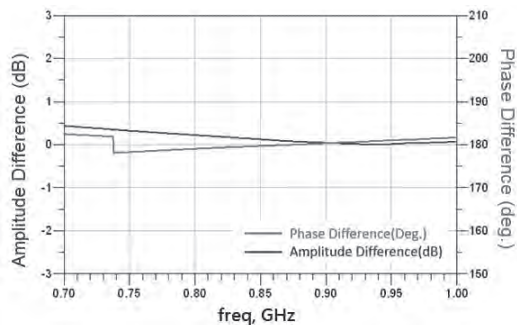

TYPICAL ELECTRICAL CHARACTERISTICS

RFBLN20120G9D5T

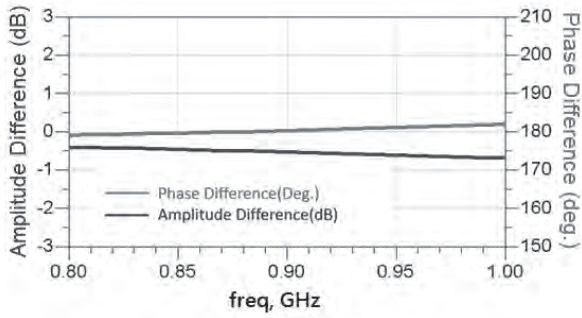

RFBLN20120G9D8T

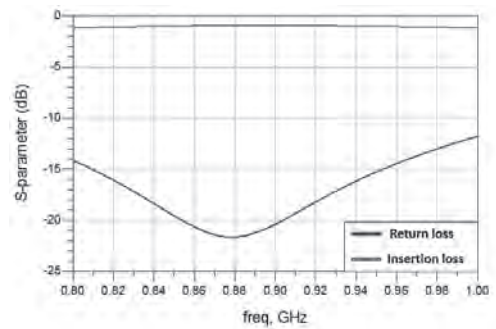
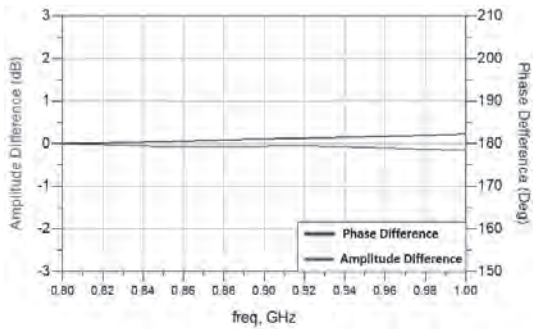

RFBLN06051G8DM1T69

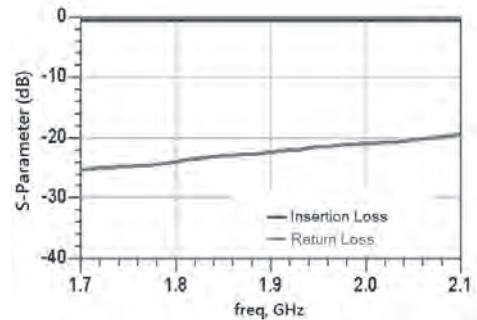
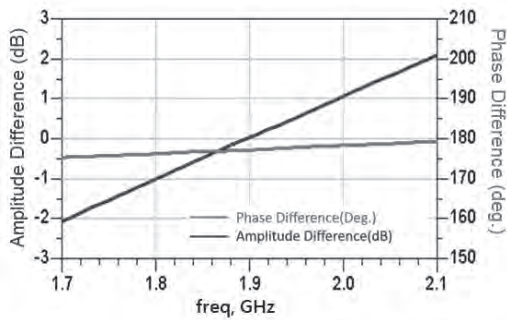

RFBLN06051G8D1T

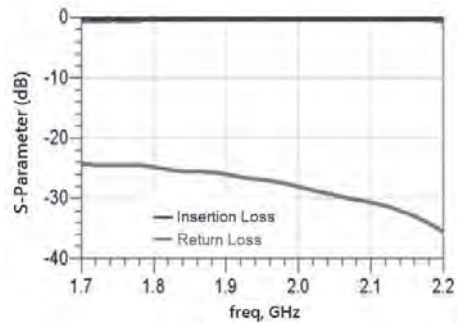
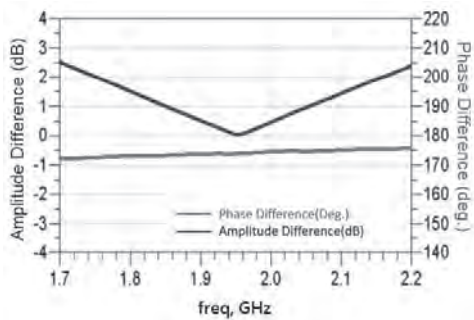

RFBLN20121G8D1T

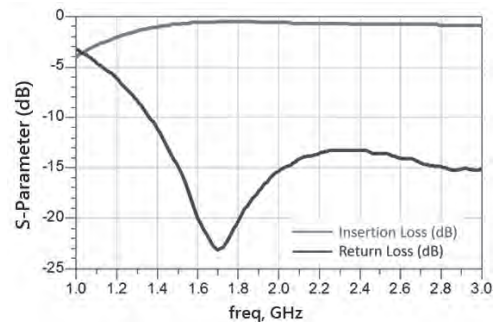
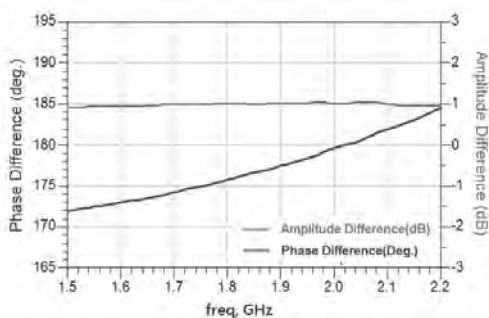

TYPICAL ELECTRICAL CHARACTERISTICS

RFBLN10051G9D0T

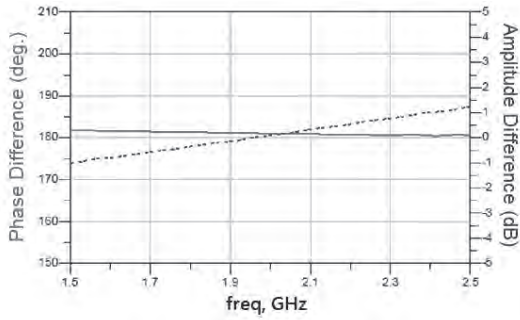

RFBLN10051G9D1T

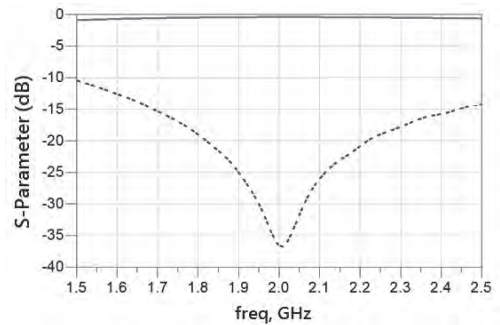
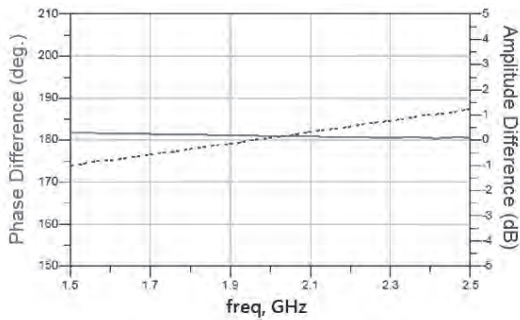

RFBLN1005040F0T

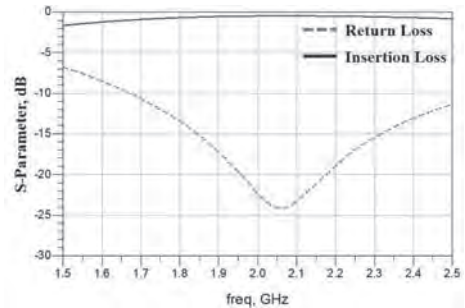
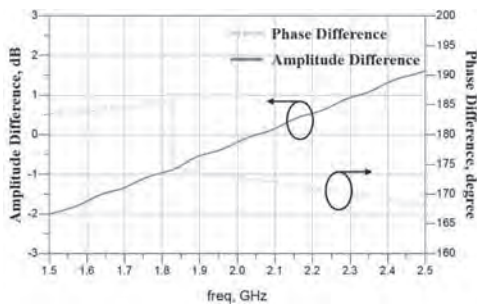

RFBLN1608070F48Q1C

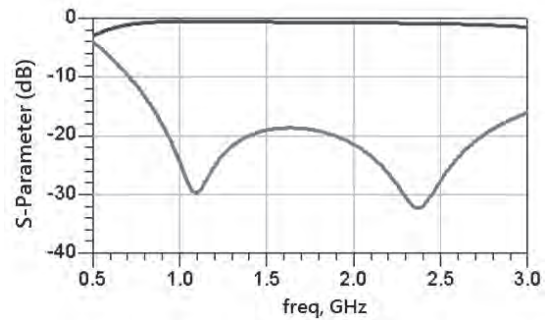
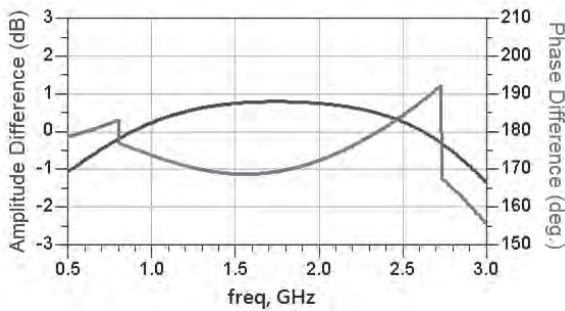

RFBLN2012090F0T

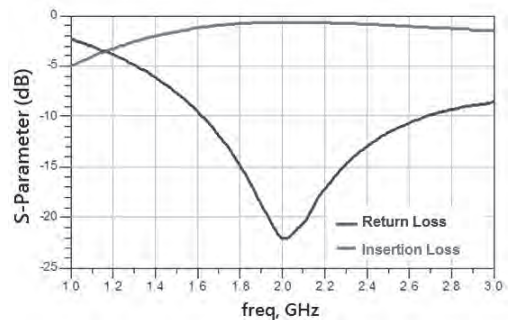
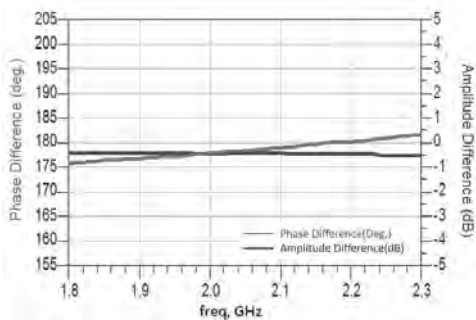

TYPICAL ELECTRICAL CHARACTERISTICS

RFBLN0605040E0T

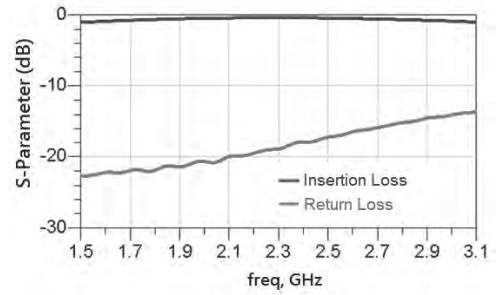
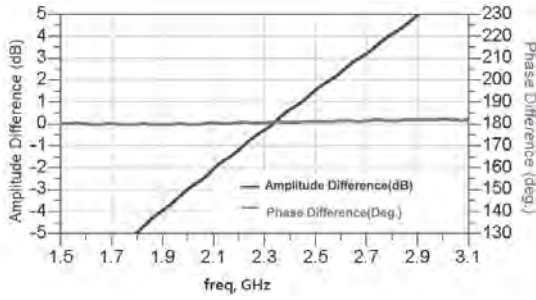

RFBLN2012090E0T

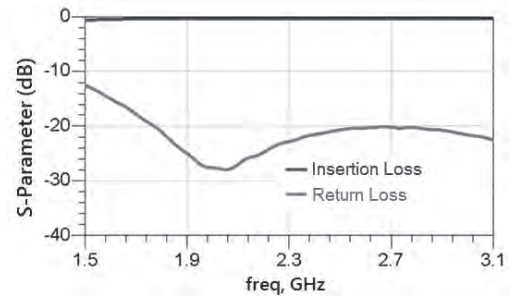
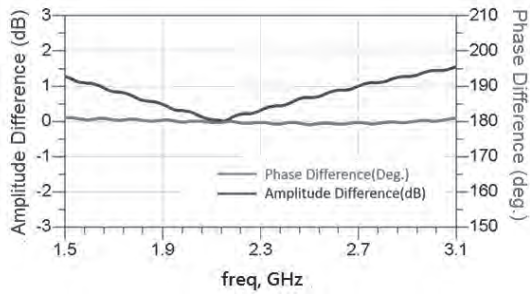

RFBLN06052G5WM9T16

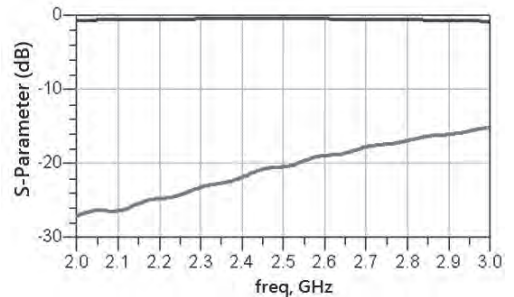
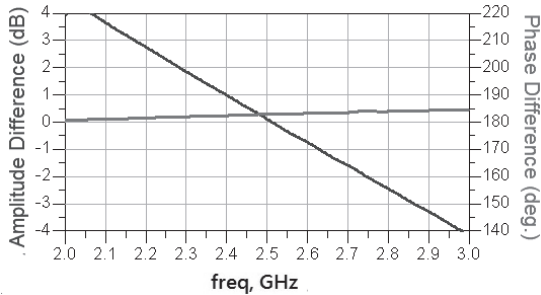

RFBLN10052G5WM9T16

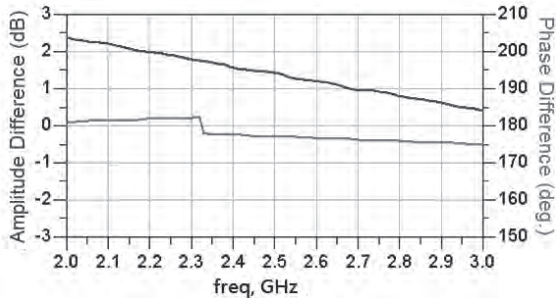

RFBLN10052G5W37N2T

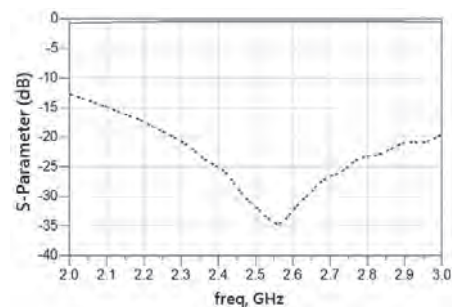
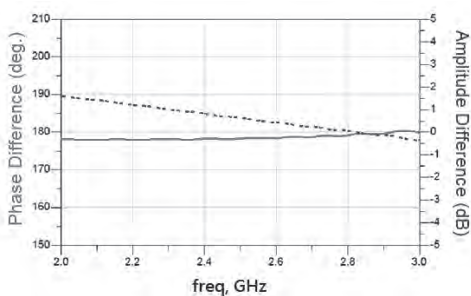

TYPICAL ELECTRICAL CHARACTERISTICS

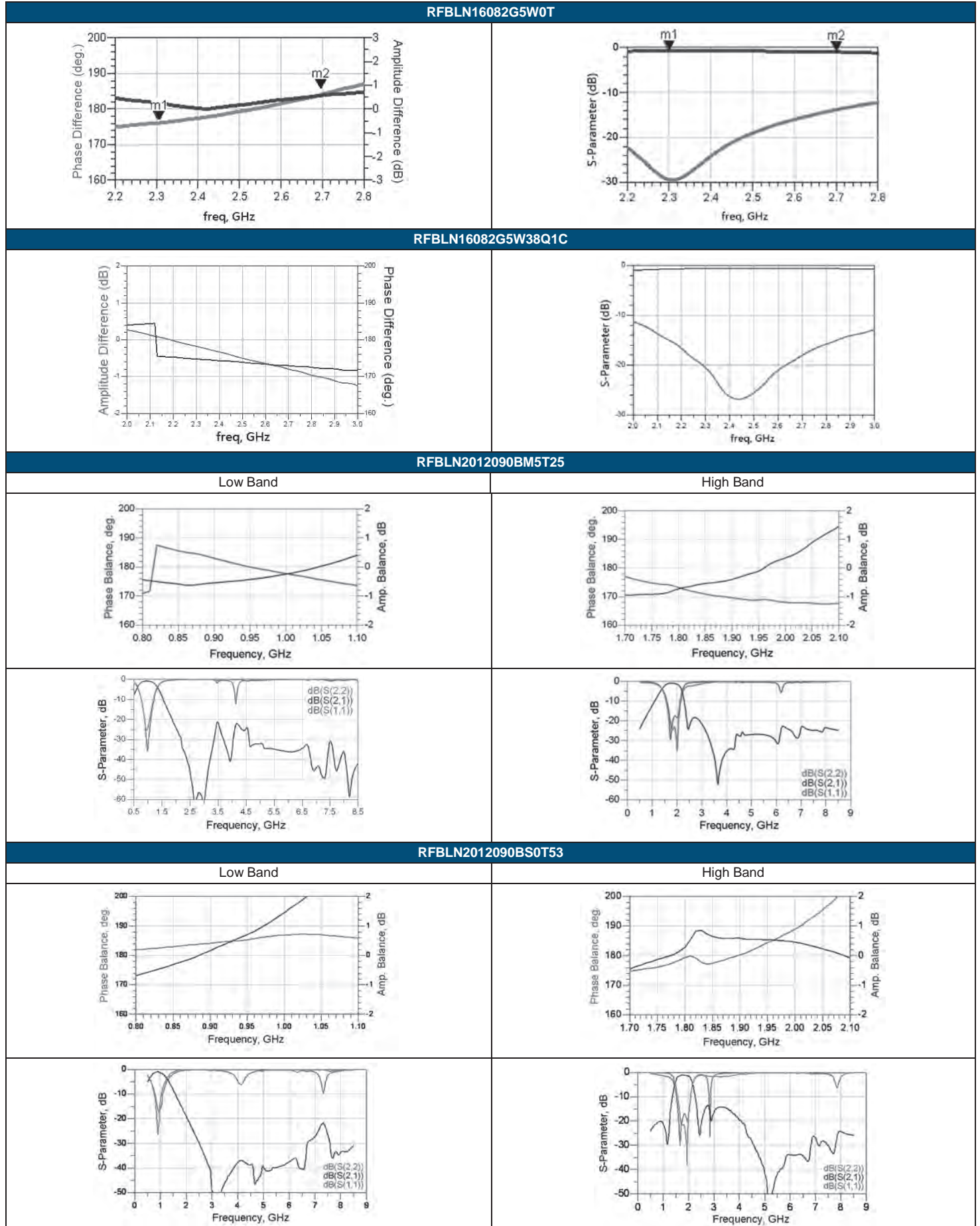

- For more information, please contact with local sales representative
- All specifications are subject to change without notice

DIPLEXER

■ **STRUCTURE AND PIN ASSOCIATED**

STRUCTURE A				
	<p>STRUCTURE A-1</p> <p>GND Common GND</p> <p>High Band GND Low Band</p>	<p>STRUCTURE A-2</p> <p>GND Common GND</p> <p>Low Band GND High Band</p>	<p>STRUCTURE A-3</p> <p>Low Band GND High Band</p> <p>GND Common GND</p>	<p>STRUCTURE A-4</p> <p>High Band GND Low Band</p> <p>GND Common GND</p>
STRUCTURE B	STRUCTURE C	STRUCTURE D	STRUCTURE E	
STRUCTURE B-1	STRUCTURE C-1	STRUCTURE D-1	STRUCTURE E-1	
STRUCTURE B-2	STRUCTURE C-2	STRUCTURE D-2	STRUCTURE E-2	
STRUCTURE F	STRUCTURE G	STRUCTURE H		

■ **STRUCTURE AND DIMENSION**

Unit: mm

Structure\ Dimension	L	W	T	A	B	C	D	E	F
A	1.60±0.15	0.80±0.15	0.60±0.10	0.175±0.15	0.25±0.15	0.25±0.15	0.50±0.15	0.20±0.15	-
	2.00±0.10	1.25±0.20	0.55±0.15	0.20±0.15	0.30±0.15	0.35±0.15	0.65±0.15	0.20±0.10	-
	2.00±0.15	1.25±0.15	0.95±0.10	0.20±0.20	0.30±0.20	0.35±0.20	0.65±0.20	-	-
B	1.60±0.15	0.80±0.15	0.60±0.10	0.65±0.15	0.30±0.15	0.20±0.15	0.20±0.15	0.25±0.15	0.30±0.15
C	2.00±0.15	1.25±0.15	0.70±0.10	0.35±0.10	0.30±0.10	0.65±0.10	0.60±0.10	0.275±0.10	-
			0.90±0.10	0.35±0.10	0.30±0.10	0.65±0.10	0.60±0.10	0.275±0.10	-
	2.50±0.15	2.00±0.15	0.80±0.15	0.30±0.15	0.35±0.15	0.65±0.15	0.75±0.15	0.525±0.15	-
D	1.60±0.15	0.80±0.15	0.60±0.10	0.175±0.15	0.25±0.15	0.25±0.15	0.50±0.15	0.20±0.15	-
E	2.50±0.15	2.00±0.15	0.70±0.10	0.30±0.10	0.40±0.10	0.60±0.10	1.10±0.10	-	-
F	2.50±0.15	2.00±0.15	1.0max.	0.375±0.15	0.25±0.15	0.25±0.15	0.50±0.15	0.20±0.15	-
G	1.60±0.15	0.80±0.15	0.60±0.10	0.65±0.15	0.30±0.15	0.20±0.15	0.20±0.15	0.25±0.15	0.30±0.15
H	1.00±0.10	0.50±0.10	0.40max.	0.10±0.10	0.30±0.10	0.20±0.10	0.50±0.10	0.125±0.10	-

■ **ELECTRICAL SPECIFICATION**

ISM Band 2.4GHz/5GHz APPLICATION

Part Number	Frequency (MHz)	Impedance (Ω)	Insertion Loss (dB)	Attenuation (dB)	Return Loss (dB) Min	Isolation	Size (mm)	Structure
RFDIP1004L10AT	2400~2500	50	0.5(25°C) 0.6(-40~+85°C)	25(4800~6000MHz) 25(7200~7500MHz)	10	-	1.00x0.50x0.40	H
	4900~5900	50	0.8(25°C) 1.3(-40~+85°C)	27(30~2400MHz) 30(2400~2500MHz) 24(2500~2690MHz) 20(9800~11900MHz)				
RFDIP1608060LCT	2400~2500	50	0.6	20(4800~5000MHz) 20(7200~7500MHz)	10	28(30~2700 MHz) 26(4900~5950 MHz)	1.60x0.80x0.60	A-4
	4900~5900	50	1.4	28(30~2700MHz) 10(9800~11900MHz)				
RFDIP1608060LET	2400~2500	50	0.6	18(4800~5000MHz) 18(7200~7500MHz)	10	-	1.60x0.80x0.60	A-1
	4900~5900	50	1.4	20(3700~3900MHz) 20(1800~2500MHz) 10(9800~11800MHz)				
RFDIP1608060LFT	2400~2500	50	0.6	18(4800~5000MHz) 18(7200~7500MHz)	10	-	1.60x0.80x0.60	A-2
	4900~5900	50	1.4	20(3700~3900MHz) 20(1800~2500MHz) 10(9800~11800MHz)				
RFDIP160806BLM6T25	2400~2500	50	0.5	10(3600~3750MHz) 20(4800~5000MHz) 20(5000~5950MHz) 10(7200~7500MHz) 10(9600~10000MHz)	10	-	1.60x0.80x0.60	A-1
	4900~5950	50	0.6	25(860~960MHz) 25(1545~1605MHz) 25(1710~1990MHz) 30(2170 MHz) 10(8100~8800MHz) 15(8820~9800MHz) 25(9800~11900MHz)				
RFDIP160806ALM6T30	2400~2500	50	0.5	10(3600~3750MHz) 20(4800~5000MHz) 20(5000~5950MHz) 10(7200~7500MHz) 10(9600~10000MHz)	10	-	1.60x0.80x0.60	A-2
	4900~5950	50	0.6	25(860~960MHz) 25(1545~1605MHz) 25(1710~1990MHz) 30(2170MHz) 10(8100~8800MHz) 15(8820~9800MHz) 25(9800~11900MHz)				
RFDIP1608060LM0T60	2400~2500	50	0.75(25°C) 0.95(-40~+85°C)	20(4800~5000MHz) 20(7200~7500MHz)	10	-	1.60x0.80x0.60	A-2
	4900~5950	50	1.0(25°C) 1.3(-40~+85°C)	20(1800~2500MHz) 20(9800~11800MHz)				

ISM Band 2.4/5GHz Application

Part Number	Frequency (MHz)	Impedance (Ω)	Insertion Loss (dB)	Attenuation (dB)	Return Loss (dB) Min	Isolation	Size (mm)	Structure
RFDIP160806BLM6T68	2400-2500	50	0.50(25°C) 0.65(-40~+85°C)	21(4800-5000MHz) 21(5000-5950MHz) 25(7200-7500MHz)	10	32(2400-2500MHz) 25(4900-6000MHz)	10	A-2
	4900-5950	50	0.60(25°C) 0.75(-40~+85°C)	27(824-2170MHz) 30(2400-2500MHz) 20(9800-11900MHz)				
RFDIP1608060LVT	2400-2500	50	0.6	-	10	32 (30-2700 MHz) 28(4900-5950 MHz)	1.60x0.80x0.60	A-4
	4900-5950	50	0.8	32(30-2700MHz) 15(9800-11900MHz) 11(14700-17850MHz)				
RFDIP1608060LST	2400-2500	50	0.5(25°C) 0.6(-40~+85°C)	22(4800-5000MHz) 24(7200-7500MHz)	10	-	1.60x0.80x0.60	G
	5100-5900	50	1.1(25°C) 1.3(-40~+85°C)	25(1800-2500MHz) 24(3700-3900MHz) 22(9800-11900MHz)				
RFDIP1608060LY8Q1C	2400-2496	50	0.5	35(4800-5000MHz) 15(7200-7500MHz)	12	-	1.60x0.80x0.60	A-3
	5150-5950	50	1.0	30(70-2000MHz) 30(2400-2690MHz) 12(7250-7800MHz) 25(10300-12000MHz) 10(15000-18000MHz)				
RFDIP1606L168M1U	2400-2500	50	0.55(25°C) 0.60(-40~+85°C)	29(4800-5000MHz) 24(7200-7500MHz)	10	32(30-2700MHz) 28(4900-5950 MHz)	1.60x0.80x0.60	A-3
	4900-5950	50	0.70(25°C) 0.80(-40~+85°C)	32(30-2700MHz) 15(9800-11900MHz) 11(14700-17850MHz)				
RFDIP1606L23T	2400-2500	50	0.6	23(4800-5000MHz) 30(7200-7500MHz)	10	-	1.60x0.80x0.60	A-3
	5150-5850	50	1.5	25(2400-2500MHz) 15(3400-3600MHz) 10(3600-3900MHz) 20(6900-7550MHz) 30(10600-11700MHz) 20(15300-16200MHz)				
RFDIP1606L24T	2400-2500	50	0.5	23(4800-5000MHz) 30(7200-7500MHz)	10	-	1.60x0.80x0.60	A-4
	5150-5850	50	0.6	25(2400-2500MHz) 15(3400-3600MHz) 10(3600-3900MHz) 20(6900-7550MHz) 30(10600-11700MHz) 20(15300-16200MHz)				
RFDIP1606L29T	2400-2500	50	0.75(25°C) 0.95(-40~+85°C)	25(4800-5000MHz) 20(7200-7500MHz)	10	-	1.60x0.80x0.60	A-2
	4900-5950	50	1.10(25°C) 1.30(-40~+85°C)	20(1800-2500MHz) 15(9800-11900MHz)				
RFDIP1606L51T	2400-2500	50	0.35(25°C) 0.45(-40~+85°C)	20(4800-5000MHz) 22(5000-5950MHz) 20(7200-7500MHz)	10	-	1.60x0.80x0.60	B-2
	4900-5850	50	0.50(25°C) 0.60(-40~+85°C)	26(824-2170MHz) 30(2400-2500MHz) 25(9500-11900MHz)				
RFDIP1606L52T	2400-2500	50	0.40(25°C) 0.45(-40~+85°C)	21(4800-5000MHz) 23(5000-5500MHz) 28(5500-5950MHz) 21(7200-7500MHz)	10	-	1.60x0.80x0.60	B-1
	4900-5850	50	0.50(25°C) 0.60(-40~+85°C)	27(824-2170MHz) 31(2400-2500MHz) 26(9800-11900MHz)				
RFDIP1606L53T	2400-2500	50	0.5	10(3600-3750MHz) 20(4800-5000MHz) 20(5000-5950MHz) 10(7200-7500MHz) 10(9600-10000MHz)	10	-	1.60x0.80x0.60	A-3
	5150-5850	50	0.6	25(860-960MHz) 25(1545-1605MHz) 25(1710-1990MHz) 30(2170MHz) 25(2400-2500MHz) 10(8100-8800MHz) 15(8820-9800MHz) 25(9800-11900MHz)				

ISM Band 2.4/5GHz Application

Part Number	Frequency (MHz)	Impedance (Ω)	Insertion Loss (dB)	Attenuation (dB)	Return Loss (dB)Min	Isolation	Size (mm)	Structure
RFDIP1606L54T	2400-2500	50	0.5	10(3600-3750MHz) 20(4800-5000MHz) 20(5000-5950MHz) 10(7200-7500MHz) 10(9600-10000MHz)	10	-	1.60x0.80x0.60	A-4
	4900-5950	50	0.6	25(860-960MHz) 25(1545-1605MHz) 25(1710-1990MHz) 30(2170MHz) 25(2400-2500MHz) 10(8100-8800MHz) 15(8820-9800MHz) 25(9800-11900MHz)				
RFDIP1607L898D1T	2400-2500	50	0.90(25°C) 1.05(-40~+85°C)	15(700-1300MHz) 25(4800-5000MHz) 30(7000-7500MHz)	10	30(2400-2500MHz) 25(4900-5950MHz)	1.60x0.80x0.70	A-4
	4900-5950	50	0.80(25°C) 0.95(-40~+85°C)	27(1200-1500MHz) 26(1500-2000MHz) 20(2300-3000MHz) 25(9800-11900MHz) 15(14700-17850MHz)				
RFDIP1606L110C8Q1C	2400-2500	50	0.48(25°C) 0.58(-40~+85°C)	20(4800-5000MHz) 22(5000-5950MHz) 20(7200-7500MHz)	10	-	1.60x0.80x0.60	A-3
	4900-5950	50	0.68(25°C) 0.78(-40~+85°C)	26(824-2170MHz) 30(2400-2500MHz) 25(9800-11900MHz) 20(15450-17550MHz)				
RFDIP1608060LS3T55	2400-2500	50	0.60(25°C) 0.65(-40~+85°C)	32(4800-4992MHz) 24(7200-7488MHz)	10	32(30-2700MHz) 28(4900-5950MHz)	1.60x0.80x0.60	A-4
	4900-5950	50	0.70(25°C) 0.80(-40~+85°C)	32(30-2700MHz) 15(9800-11900MHz) 11(14700-17850MHz)				
KFDIP2004L157B1U	2400-2500	50	0.5	10(3600MHz) 20(4800-5000MHz) 20(7200-7500MHz)	10	20(DC-2500MHz) 20(4900-5950MHz)	2.00x1.25x0.40	A-3
	4900-5950	50	1.0	20(824-915MHz) 20(1800-2500MHz) 10(3000-3900MHz) 4(7250MHz) 20(9800-11900MHz) 20(14700-17850MHz)				
KFDIP2004L167B1U	2400-2500	50	0.5	10(3600MHz) 20(4800-5000MHz) 20(7200-7500MHz)	10	20(DC-2500MHz) 20(4900-5950MHz)	2.00x1.25x0.40	A-4
	4900-5950	50	1.0	20(824-915MHz) 20(1800-2500MHz) 10(3000-3900MHz) 4(7250MHz) 20(9800-11900MHz) 20(14700-17850MHz)				
KFDIP2004L197B1U	2400-2500	50	0.6	15(3600MHz) 25(4800-5000MHz) 20(7200-7500MHz)	10	20(DC-2500MHz) 20(4900-5950MHz)	2.00x1.25x0.40	A-3
	4900-5950	50	1.0	20(824-915MHz) 18(1800-2500MHz) 14(3000-3900MHz) 20(9800-11900MHz) 20(14700-17850MHz)				
RFDIP2012050L5T	2400-2500	50	0.7	18(4800-6000MHz) 18(7200-7500 MHz)	10	-	2.00x1.25x0.55	A-1
	4900-5900	50	1.0	19(1800-2500MHz) 25(10300-10700MHz)				
RFDIP2012050L7T	2400-2500	50	0.7	18(4800-6000MHz) 18(7200-7500MHz)	10	-	2.00x1.25x0.55	A-2
	4900-5900	50	1.0	19(1800-2500MHz) 25(10300-10700MHz)				
RFDIP2012050L8T	2300-2500	50	0.65(25°C) 0.8(-40~+85°C)	20(4600-5000MHz) 20(6900-7500MHz)	10	-	2.00x1.25x0.55	A-3
	4900-5950	50	1.0	19(1800-2500MHz) 25(10300-10700MHz)				

ISM Band 2.4/5GHz Application

Part Number	Frequency (MHz)	Impedance (Ω)	Insertion Loss (dB)	Attenuation (dB)	Return Loss (dB) Min	Isolation	Size (mm)	Structure
RFDIP2012100L0T	2400-2500	50	0.7	20(4900MHz) 25(5200MHz) 25(5800MHz)	10	-	2.00x1.25x0.95	A-3
	4900-5900	50	0.9	25(2450MHz)				
RFDIP2012100L3T	2400-2500	50	0.7	20(4900MHz) 25(5200MHz) 25(5800MHz)	10	-	2.00x1.25x0.95	A-2
	4900-5900	50	0.9	25(2450MHz)				
RFDIP2012050LPT	2400-2500	50	0.5(25°C) 0.55(-40~+85°C)	23(4800-6000MHz) 20(7200-7500MHz)	10	-	2.00x1.25x0.55	A-1
	4900-5950	50	0.65(25°C) 0.75(-40~+85°C)	20(800-2500MHz) 15(9800-11900MHz)				
RFDIP2012050LQT	2400-2500	50	0.5(25°C) 0.55(-40~+85°C)	23(4800-6000MHz) 20(7200-7500MHz)	10	-	2.00x1.25x0.55	A-2
	4900-5950	50	0.65(25°C) 0.75(-40~+85°C)	20(800-2500MHz) 15(9800-11900MHz)				
RFDIP2008L107N3T	2400-2500	50	2.2(25°C) 2.4(-40~+85°C)	30(824-915MHz) 30(1545-1610MHz) 30(1710-1990MHz) 25(2110-2170MHz) 8(3200-3600MHz) 12(3700-3900MHz) 28(4800-5000MHz) 25(7200-7500MHz)	10	-	2.00x1.25x0.80	A-1
	5150-5850	50	1.2(25°C) 1.5(-40~+85°C)	20(1545-1610MHz) 20(1710-1990MHz) 20(2110-2170MHz) 23(2400-2500MHz) 8(3450-3900MHz) 8(7250-7800MHz) 20(9800-11700MHz)				
RFDIP2008L117N3T	2400-2500	50	2.2(25°C) 2.4(-40~+85°C)	30(824-915MHz) 30(1545-1610MHz) 30(1710-1990MHz) 25(2110-2170MHz) 8(3200-3600MHz) 12(3700-3900MHz) 28(4800-5000MHz) 25(7200-7500MHz)	10	-	2.00x1.25x0.80	A-2
	5150-5850	50	1.2(25°C) 1.5(-40~+85°C)	20(1545-1610MHz) 20(1710-1990MHz) 20(2110-2170MHz) 23(2400-2500MHz) 8(3450-3900MHz) 8(7250-7800MHz) 20(9800-11700MHz)				
AMDIP2520070L3T	2400-2500	50	2.4(25°C) 2.7(-40~+85°C)	30(824-915MHz) 30(1545-1610MHz) 24(1710-1990MHz) 15(2110-2170MHz) 30(4800-5000MHz) 20(7200-7500MHz)	10	-	2.50x2.00x0.70	E-1
	5150-5850	50	1.2(25°C) 1.5(-40~+85°C)	25(1545-1610MHz) 25(2400-2500MHz) 15(10300-11700MHz)				
AMDIP2520070L4T	2400-2500	50	2.4(25°C) 2.7(-40~+85°C)	30(824-915MHz) 30(1545-1610MHz) 24(1710-1990MHz) 15(2110-2170MHz) 30(4800-5000MHz) 20(7200-7500MHz)	10	-	2.00x1.25x0.80	E-2
	5150-5850	50	1.2(25°C) 1.5(-40~+85°C)	25(1545-1610MHz) 25(2400-2500MHz) 15(10300-11700MHz)				

GPS 1.575GHz/ISM 2.4GHz/5GHz Band Application

Part Number	Frequency (MHz)	Impedance (Ω)	Insertion Loss (dB)	Attenuation (dB)	Return Loss (dB)Min.	Size (mm)	Structure
RFDIP1608060T1T	1574-1577	50	0.65	20(2400-2500MHz)	10	1.60x0.80x0.60	B-1
	2400-2500	50	0.8	20(1574-1577MHz)			
RFDIP1608060TM7T62	1570-1610	50	0.6(typ.0.5)	20(2400-2500MHz) 20(4900-5900MHz)	10	1.60x0.80x0.60	A-4
	2400-2500 4900-5900	50	0.65(typ.0.55)	20(1570-1610MHz)			
RFDIP1608060TAT	698-960 1427-1511 1560-1607	50	0.40 0.55 0.65	20(2400-2500MHz) 20(2620-2690MHz) 20(5150-5850MHz)	10	1.60x0.80x0.60	B-1
	2400-2500 2620-2690 5150-5850	50	0.70 0.60 0.80	20(698-960MHz) 20(1427-1511MHz) 20(1560-1607MHz)			
RFDIP1608060TCT	1570-1610	50	0.6(typ.0.5)	20(2400-2500MHz) 20(4900-5900MHz)	10	1.60x0.80x0.60	A-4
	2400-2500 4900-5900	50	0.65(typ.0.55)	20(1570-1610MHz)			
RFDIP1608060TDT	1570-1610	50	0.65(25°C) 0.75(-40~+85°C)	13(2170MHz) 20(2400-2500MHz)	10	1.60x0.80x0.60	B-2
	2400-2500	50	0.80(25°C) 0.90(-40~+85°C)	20(1565-1616MHz) 15(1710MHz)			
RFDIP2012090T2T	1572.5-1578.5 1597-1607	50	0.40 0.50	13(2400-2500MHz)	10	2.00x1.25x0.90	A-3
	2400-2500	50	0.55(25°C) 0.65(-40~+85°C)	22(1572.5-1578.5MHz) 20(1597-1607MHz)			
RFDIP2520080T1T	1710-1990 1990-2110 2110-2170	50	1.00 1.50 2.50	5(2300-2350MHz) 10(2350-2500MHz) 10(2500-2690MHz)	10	2.50x2.00x0.80	C-2
	2300-2350 2350-2500 2500-2690	50	2.65 1.50 0.65	8(1710-1990MHz) 8(1990-2110MHz) 5(2110-2170MHz)			

892 MHz & 1.94GHz Band Working Frequency

Part Number	Frequency (MHz)	Impedance (Ω)	Insertion Loss (dB)	Attenuation (dB)	Return Loss (dB)Min.	Size (mm)	Structure
RFDIP1608070GM1T76	698-960	50	0.8(typ.0.45)	25(1710-2700MHz)	10	1.60x0.80x0.60	D-2
	1710-2700		0.7(typ.0.50)	20(698-960MHz) 20(5150-5850MHz)			
RFDIP2012070G5T	570-960	50	0.75	20(1427-2700MHz)	10	2.00x1.25x0.70	C-1
	1427-2700		0.85	20(570-960MHz)			
RFDIP2012090G77N2T	698-960	50	0.65	15(1554-1580MHz) 20(1710-2700MHz)	10	2.00x1.25x0.90	A-4
	1710-2700		0.65	20(824-960MHz)			
RFDIP2012090GM1T58	698-960	50	0.4(25°C) 0.45(-40~+85°C)	13(1710-2690MHz)	10	2.00x1.25x0.90	C-1
	1710-2690		0.55(25°C) 0.65(-40~+85°C)	19(698-960MHz)			
RFDIP2520100G2T	698-960	50	0.35(25°C) 0.45(-40~+85°C)	20(1710-2690MHz)	10	2.50x2.00x1.00	F
	1710-2690		0.55(25°C) 0.65(-40~+85°C)	25(698-960MHz) 5(3420-3820MHz)			

■ **TYPICAL ELECTRICAL CHARACTERISTICS**

RFDIP1004L10T

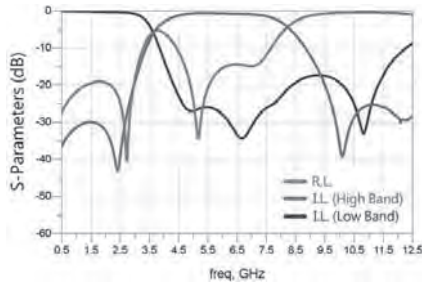

RFDIP1608060LCT

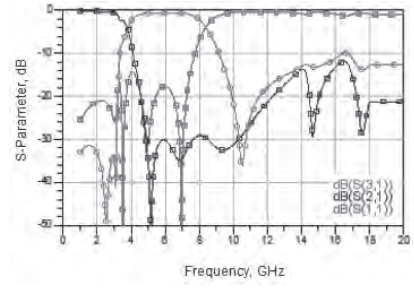

RFDIP1608060LET

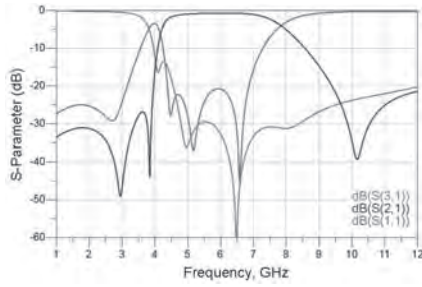

RFDIP1608060LFT

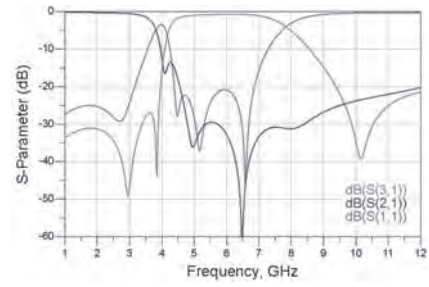

RFDIP160806BLM6T25

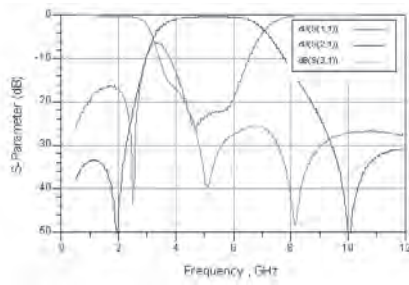

RFDIP160806ALM6T30

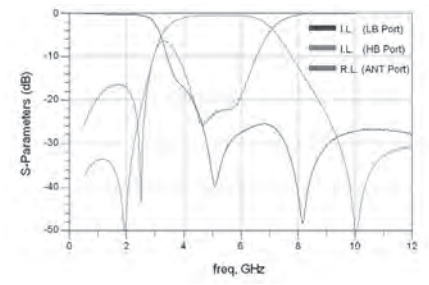

RFDIP1608060LM0T60

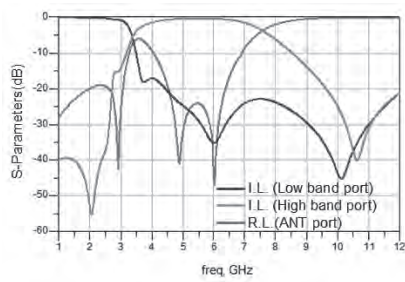

RFDIP160806BLM6T68

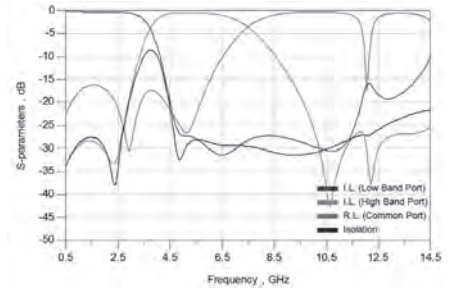

RFDIP1608060LVT

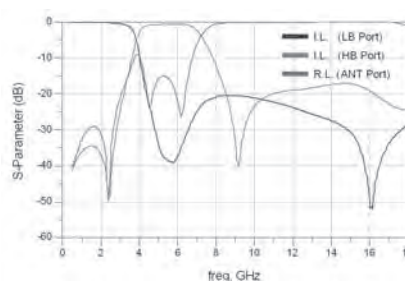

RFDIP1608060LST

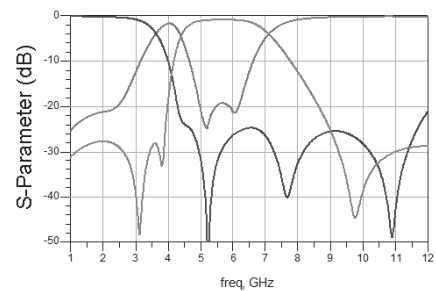

TYPICAL ELECTRICAL CHARACTERISTICS

RFDIP1608060LY8Q1C

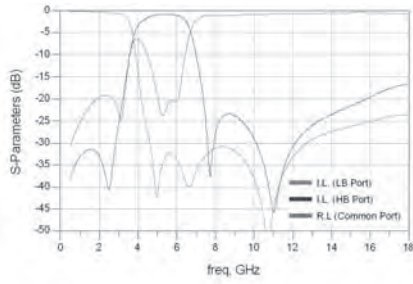

RFDIP1606L168M1U

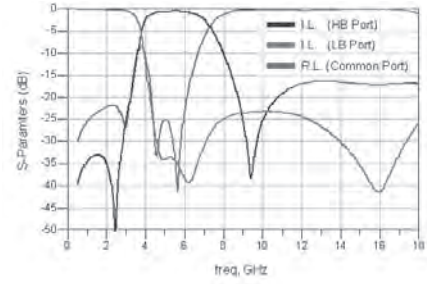

RFDIP1606L23T

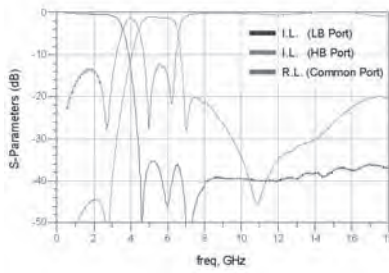

RFDIP1606L24T

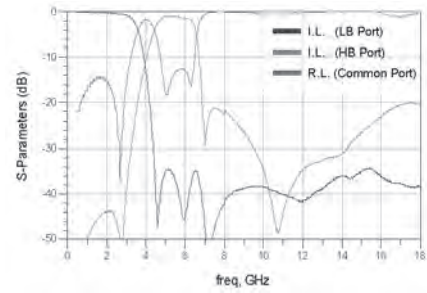

RFDIP1606L29T

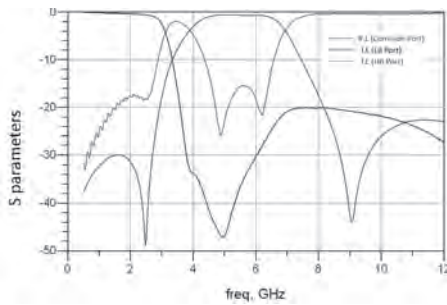

RFDIP1606L51T

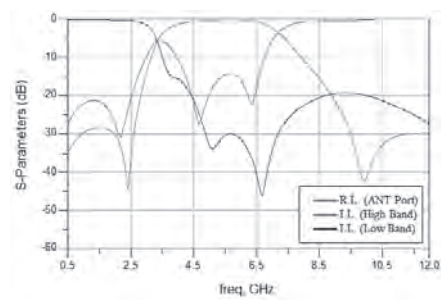

RFDIP1606L52T

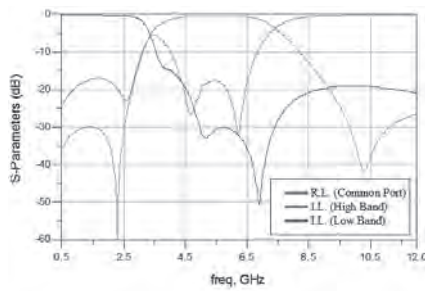

RFDIP1606L53T

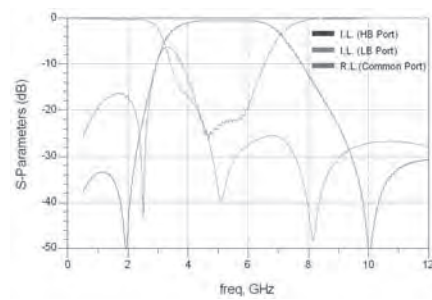

RFDIP1606L54T

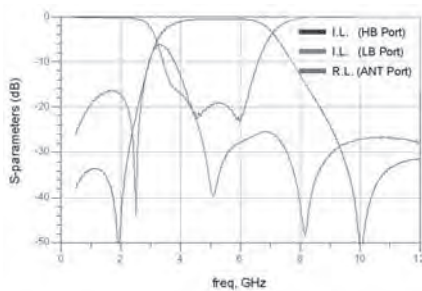

RFDIP1607L898D1T

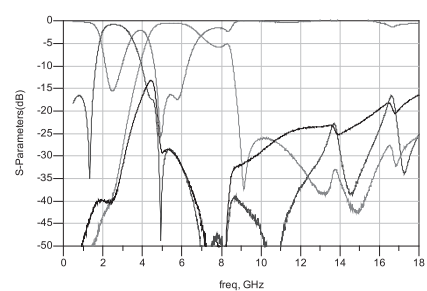

TYPICAL ELECTRICAL CHARACTERISTICS

RFDIP1606L110C8Q1C

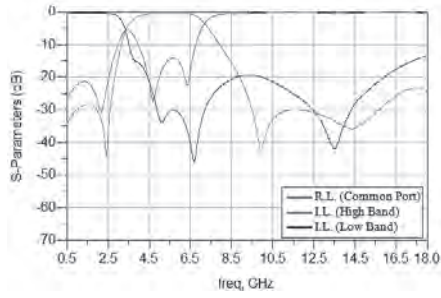

RFDIP1608060LS3T55

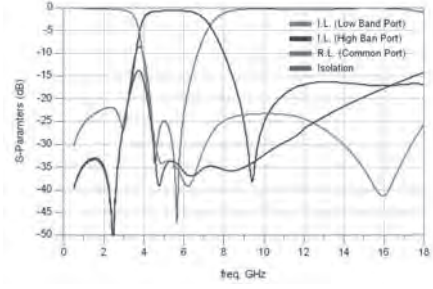

KFDIP2004L157B1U

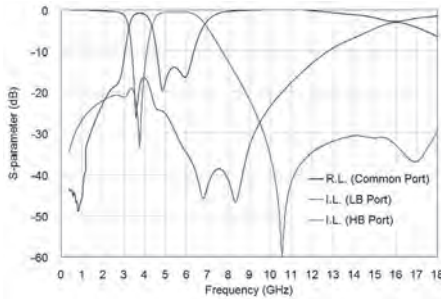

KFDIP2004L167B1U

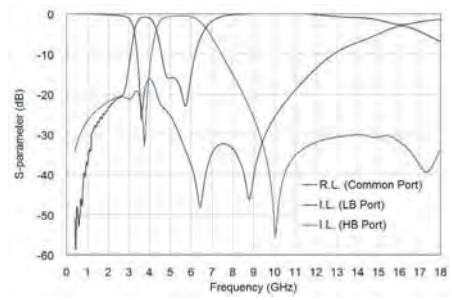

KFDIP2004L197B1U

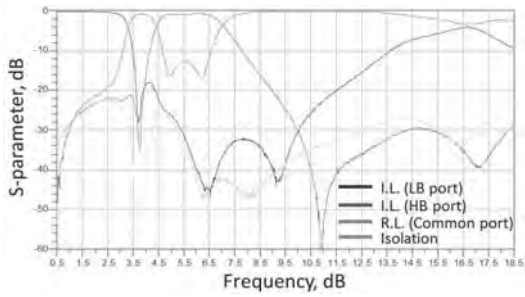

RFDIP2012050L5T

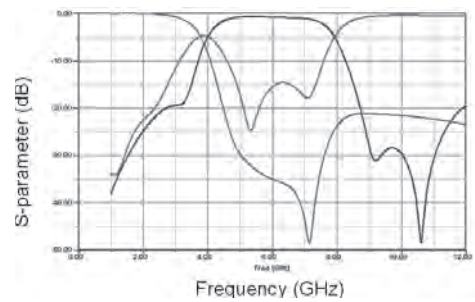

RFDIP2012050L7T

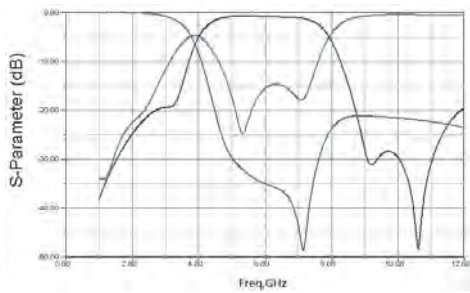

RFDIP2012050L8T

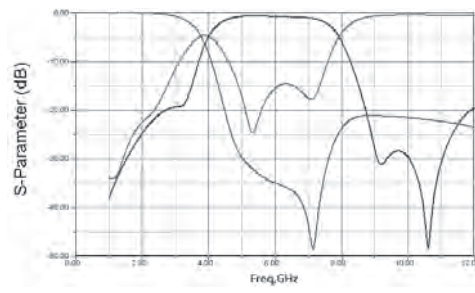

RFDIP2012050LPT

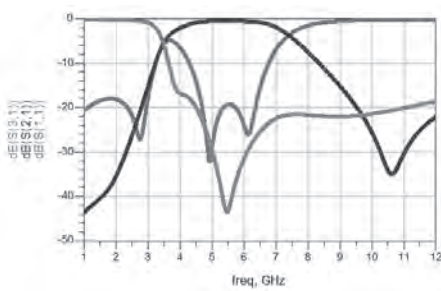

RFDIP2012050LQT

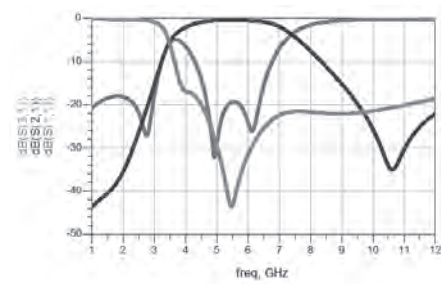

TYPICAL ELECTRICAL CHARACTERISTICS

RFDIP2008L107N3T

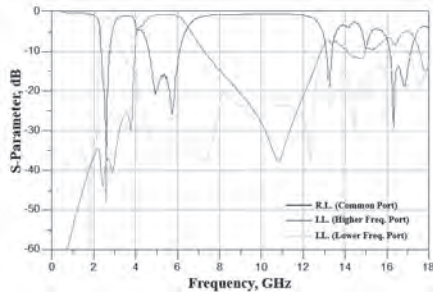

RFDIP2008L117N3T

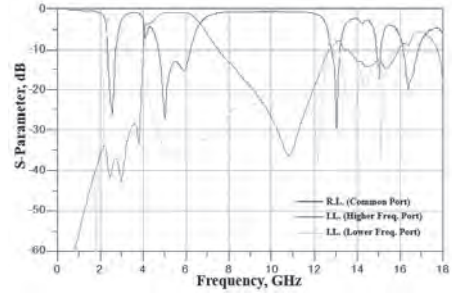

AMDIP2520070L3T

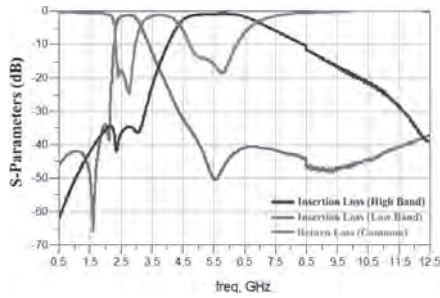

AMDIP2520070L4T

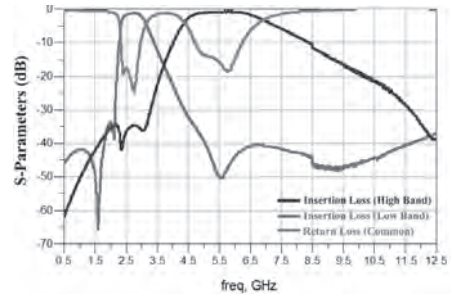

RFDIP1608060T1T

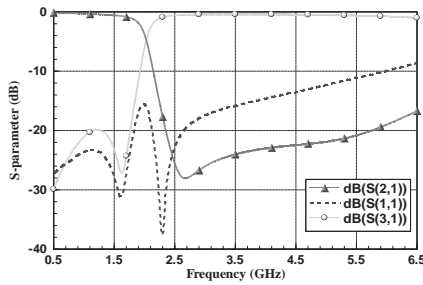

RFDIP1608060TM7T62

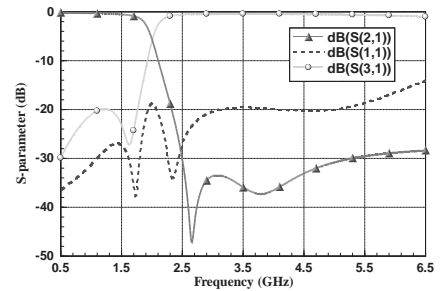

RFDIP1608060TAT

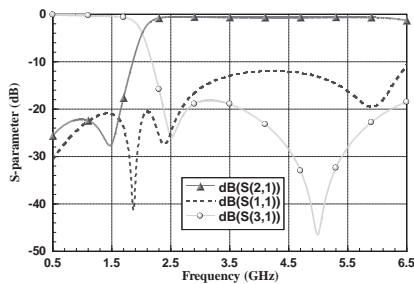

RFDIP1608060TCT

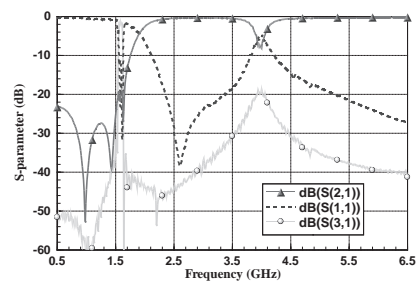

RFDIP1608060TDT

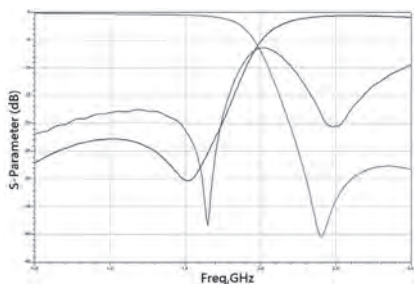

RFDIP2012090T2T

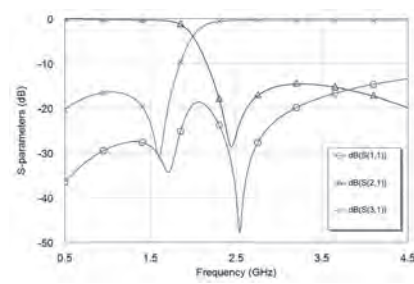

TYPICAL ELECTRICAL CHARACTERISTICS

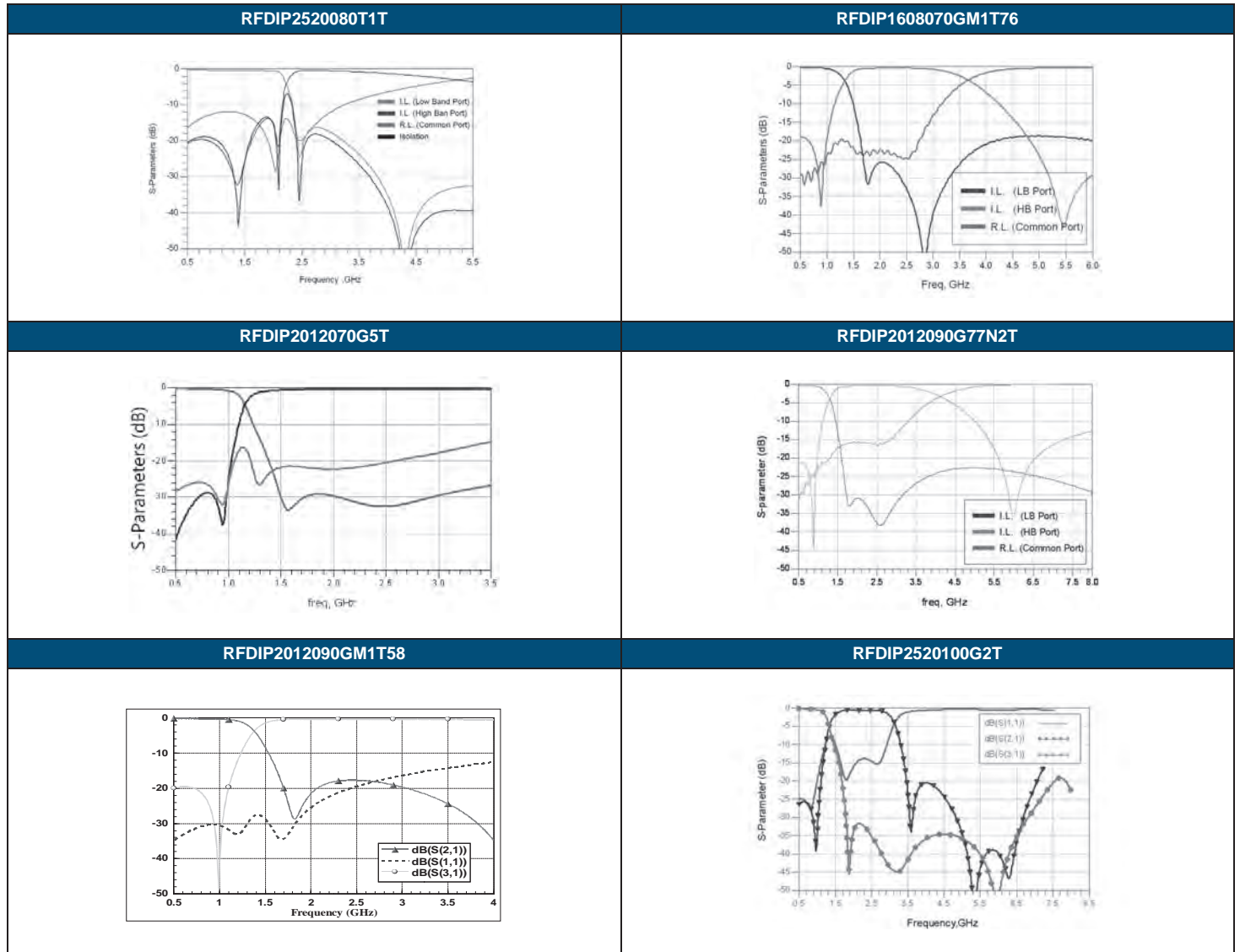

- For more information, please contact with local sales representative
- All specifications are subject to change without notice

TRIPLEXER

■ **STRUCTURE AND PIN ASSOCIATED**

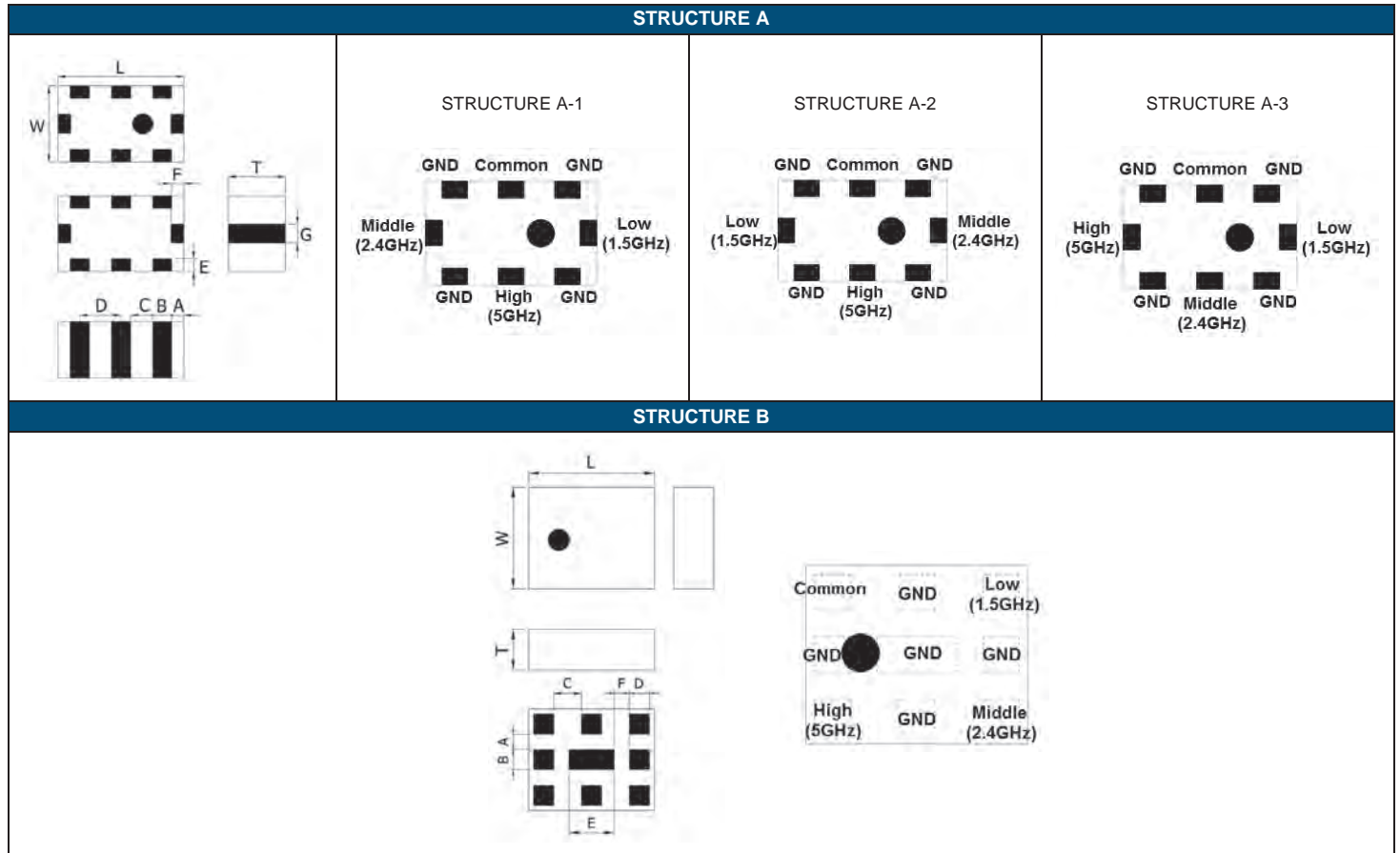

■ **STRUCTURE AND DIMENSION**

Unit: mm

Structure\ Dimension	L	W	T	A	B	C	D	E	F	G
A	2.00±0.15	1.25±0.15	0.90±0.10	0.20±0.20	0.30±0.20	0.35±0.20	0.65±0.20	0.20±0.20	0.20±0.20	0.30±0.20
B	2.50±0.15	2.00±0.15	0.90±0.10	0.30±0.10	0.40±0.10	0.55±0.10	0.40±0.10	0.90±0.10	0.30±0.10	0.30±0.10

■ **ELECTRICAL SPECIFICATION**

GPS 1.575GHz/ISM 2.4GHz/5GHz band RF application

Part Number	Frequency (MHz)	Impedance (Ω)	Insertion Loss (dB)	Attenuation (dB)	Return Loss (dB) Min	Isolation	Size (mm)	Structure
RFTIP2012090T18Q1C	1560-1606	50	0.6	15(2400-2500 MHz) 15(4800-6000 MHz)	10	-	2.00x1.25x0.90	A-1
	2400-2500	50	0.7	10(860-960 MHz) 15(1545-1605 MHz) 10(3600-3750 MHz) 20(4800-6000 MHz) 10(7200-7500 MHz) 10(9600-10000 MHz)	10	20(1559-1606 MHz) 25(4800-5000 MHz)		
	4900-5950	50	0.8	25(860-960 MHz) 25(1545-1605 MHz) 25(1710-1990 MHz) 30(2170 MHz) 10(8100-8800 MHz) 15(8820-9800 MHz) 25(9800-11900 MHz)	10	20(1559-1606 MHz)		

■ ELECTRICAL SPECIFICATION

GPS 1.575GHz/ ISM 2.4GHz/5GHz band RF application

Part Number	Frequency (MHz)	Impedance (Ω)	Insertion Loss (dB)	Attenuation (dB)	Return Loss (dB) Min	Isolation	Size (mm)	Structure
RFTIP2012090T27N3T	1560-1606	50	0.65(25°C) 0.70(-40~+85°C)	20(2400-2500 MHz) 20(4900-6000 MHz)	10	-	2.00x1.25x0.90	A-2
	2400-2500	50	0.70(25°C) 0.85(-40~+85°C)	10(860-960 MHz) 15(1545-1610 MHz) 10(3600-3750 MHz) 20(4800-6000 MHz) 10(7200-7500 MHz) 10(9600-10000 MHz)	10	20(1559-1606 MHz) 20(4800-5000 MHz)		
	4900-5950	50	0.80(25°C) 0.95(-40~+85°C)	25(1559-1606 MHz) 35(2400-2500 MHz) 12(3400-3600 MHz) 12(3600-3900 MHz) 10(6900-7200 MHz) 10(7200-7800 MHz) 25(10300-11700 MHz) 15(15300-16200 MHz)	10	20(1559-1606 MHz)		
RFTIP2012090T9T	1560-1606	50	0.7	15(2400-2500 MHz) 15(4800-6000 MHz)	10	-	2.00x1.25x0.90	A-3
	2400-2500	50	0.8	10(860-960 MHz) 15(1545-1605 MHz) 8(3600-3750 MHz) 20(4800-5000 MHz) 10(7200-7500 MHz) 10(9600-10000 MHz)	10			
	4900-5950	50	0.9	25(860-960 MHz) 25(1545-1605 MHz) 25(1710-1990 MHz) 30(2170 MHz) 38(2400-2500 MHz) 8(8100-8800 MHz) 15(8820-9800 MHz) 22(9800-11900 MHz)	10			
RFTIP2012090TLT	1560-1606	50	0.70(25°C) 0.80(-40~+85°C)	14(2400-2500 MHz) 15(4800-6000 MHz)	10	-	2.00x1.25x0.90	A-1
	2400-2500	50	0.80(25°C) 0.95(-40~+85°C)	10(860-960 MHz) 10(1545-1605 MHz) 8(3600-3750 MHz) 20(4800-5000 MHz) 10(7200-7500 MHz) 5(9600-10000 MHz)	10			
	4900-5950	50	0.90(25°C) 1.10(-40~+85°C)	24(860-960 MHz) 24(1545-1605 MHz) 25(1710-1990 MHz) 25(2170 MHz) 0.2(3920-4720 MHz) 10(8100-8800 MHz) 14(8820-9800 MHz) 20(9800-11900 MHz)	10			
RFTIP2109ATM0T63	1560-1606	50	0.60(25°C) 0.80(-40~+85°C)	15(2400-2500 MHz) 15(4800-6000 MHz)	10	-	2.00x1.25x0.90	A-1
	2400-2500	50	0.70(25°C) 0.90(-40~+85°C)	10(860-960 MHz) 15(1545-1605 MHz) 10(3600-3750 MHz) 20(4800-5000 MHz) 10(7200-7500 MHz) 10(9600-10000 MHz)	10	20(1559-1606 MHz) 25(4800-5000 MHz)		
	4900-5950	50	0.80(25°C) 1.00(-40~+85°C)	25(860-960 MHz) 25(1545-1605 MHz) 25(1710-1990 MHz) 30(2170 MHz) 10(8100-8800 MHz) 15(8820-9800 MHz) 25(9800-11900 MHz)	10	25(1559-1606 MHz)		

GPS 1.575GHz/ ISM 2.4GHz/5GHz band RF application

Part Number	Frequency (MHz)	Impedance (Ω)	Insertion Loss (dB)	Attenuation (dB)	Return Loss (dB) Min	Isolation	Size (mm)	Structure
RFTIP2109BTM5T62	1560-1606	50	0.60(25°C) 0.80(-40~+85°C)	15(2400-2500 MHz) 15(4800-6000 MHz)	10	-	2.00x1.25x0.90	A-2
	2400-2500	50	0.70(25°C) 0.90(-40~+85°C)	10(860-960 MHz) 15(1545-1605 MHz) 10(3600-3750 MHz) 20(4800-5000 MHz) 10(7200-7500 MHz) 10(9600-10000 MHz)	10	20(1559-1606 MHz) 25(4800-5000 MHz)		
	4900-5950	50	0.80(25°C) 1.00(-40~+85°C)	25(860-960 MHz) 25(1545-1605 MHz) 25(1710-1990 MHz) 30(2170 MHz) 10(8100-8800 MHz) 15(8820-9800 MHz) 25(9800-11900 MHz)	10	25(1559-1606 MHz)		
RFTIP2520090T3T	698-960	50	0.70(25°C) 0.80(-40~+85°C)	20(1710-2200 MHz) 20(2500-2690 MHz)	10	20(1710-2200 MHz) 20(2500-2690 MHz)	2.50x2.00x0.90	C
	1710-2200	50	1.40(25°C) 1.60(-40~+85°C)	20(698-960 MHz) 15(2500-2690 MHz)	10	18(698-960 MHz) 18(2500-2690 MHz)		
	2500-2690	50	1.80(25°C) 2.00(-40~+85°C)	15(698-960 MHz) 15(1710-2200 MHz)	10	20(698-960 MHz) 20(1710-2200 MHz)		

■ TYPICAL ELECTRICAL CHARACTERISTICS

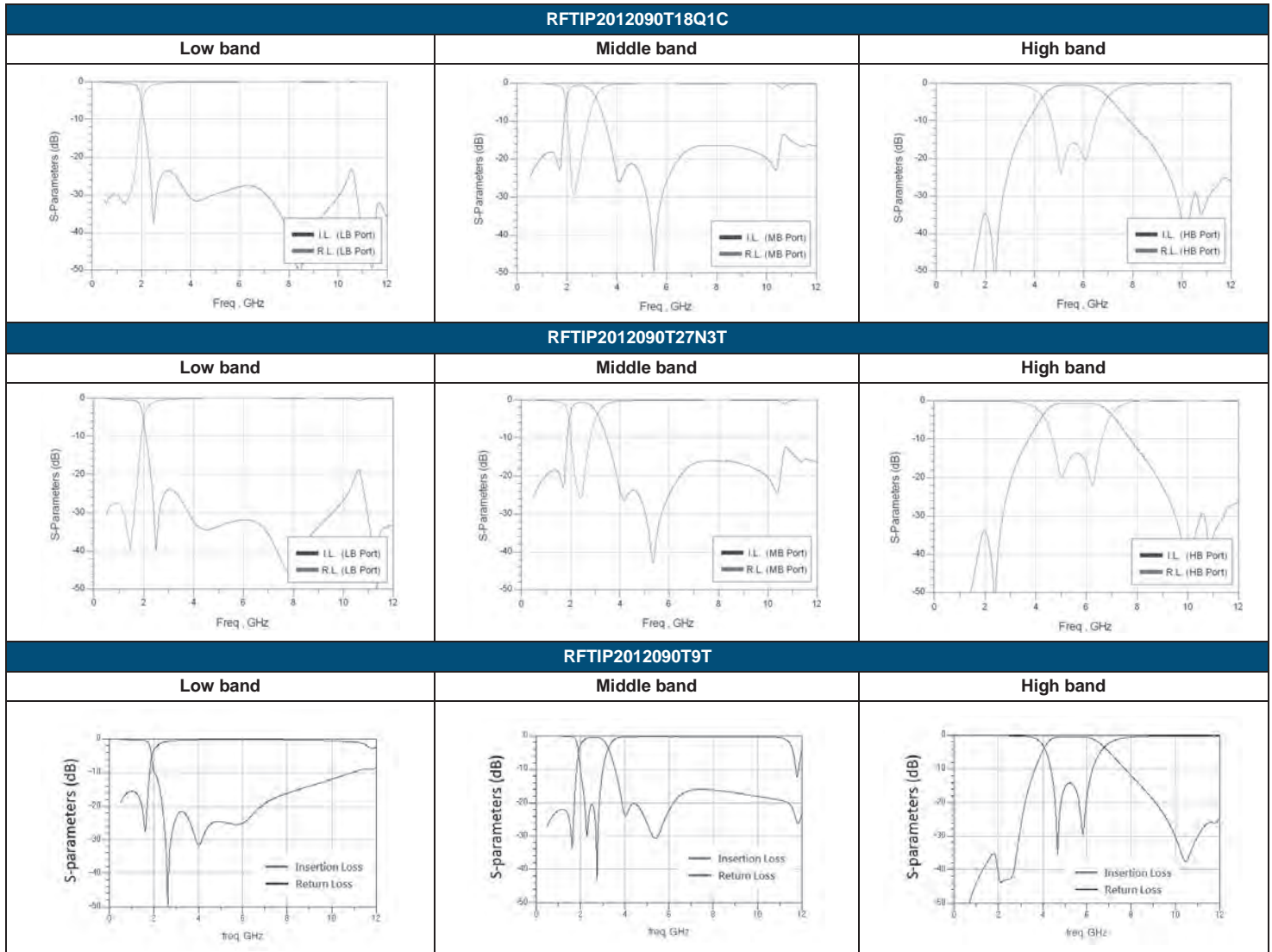

TYPICAL ELECTRICAL CHARACTERISTICS

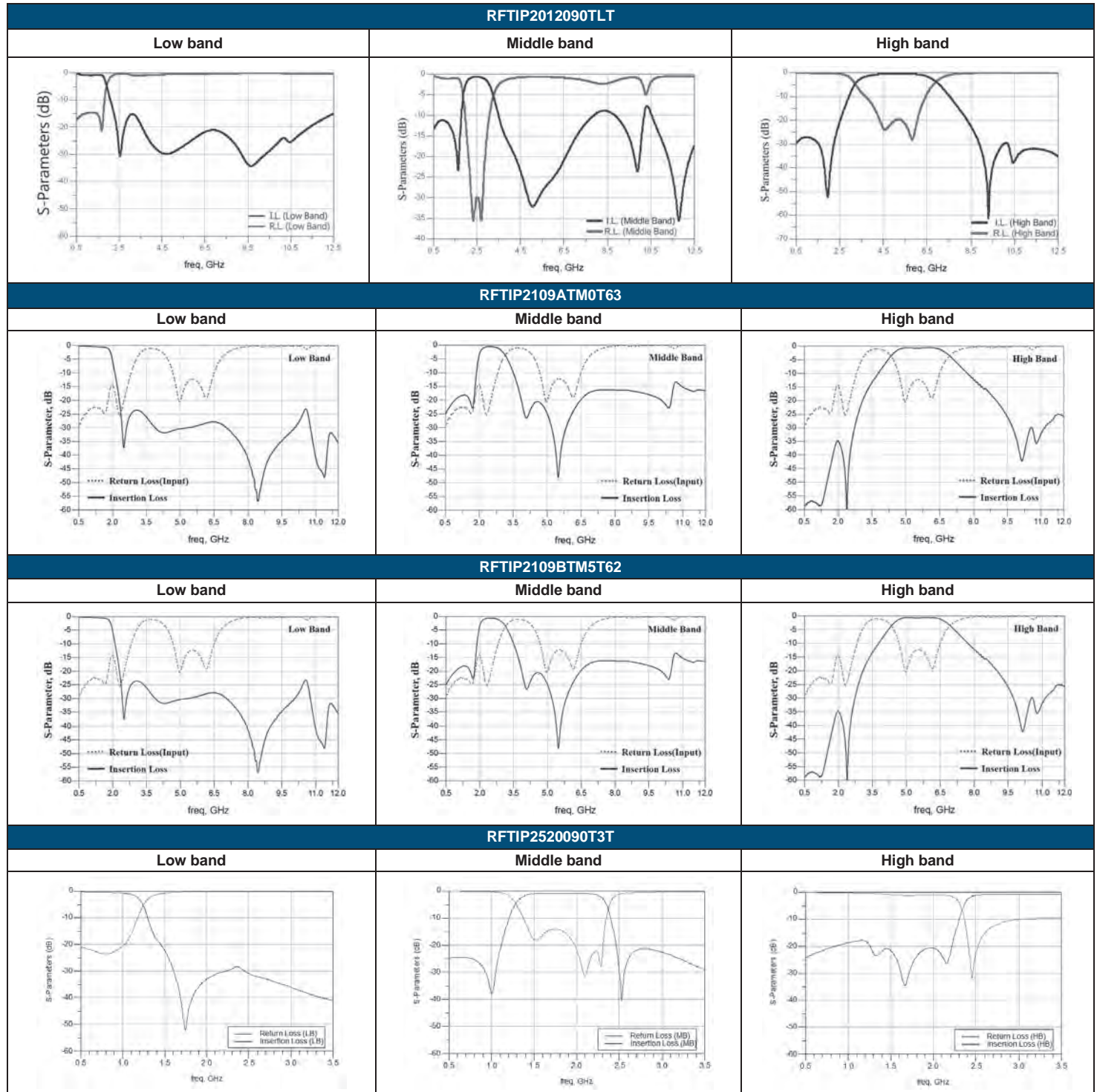

- For more information, please contact with local sales representative
- All specifications are subject to change without notice

COMMON MODE FILTER

■ **STRUCTURE AND PIN ASSOCIATED**

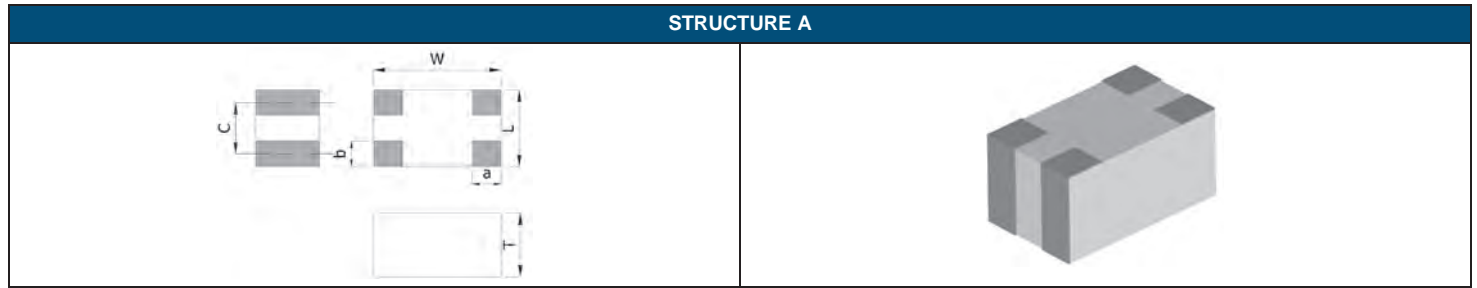

■ **STRUCTURE AND DIMENSION**

Unit: mm

Structure\ Dimension	L	W	T	a	b	c
A	1.20+0.40 -0.20	2.00+0.40 -0.20	1.00±0.20	0.45±0.20	0.40±0.20	0.80±0.10
	1.60±0.20	3.20±0.20	0.95±0.20	0.60±0.20	0.50±0.20	1.10±0.20
			1.00±0.20	0.60±0.20	0.50±0.20	1.10±0.20

■ **ELECTRICAL SPECIFICATION**

DISCRETE CMF for HIGH SPEED TRANSMISSION LINES USB2.0 IEEE1394 LVDS(mini)

Part Number	Characteristic Impedance (Differential)	Common Mode Attenuation (Min.)	DC Resistance (Ω) max.	Rated Current (mA)	Size(mm)	Structure
RFCMF1220100M3T	90 ohm	9.0(240MHz ~ 1GHz)	1.5	300	1.20x2.00x1.00	A
RFCMF1220100M4T	90 ohm	9.0(130 MHz ~ 1GHz)	2.5	200	1.20x2.00x1.00	A
RFCMF1632090M1T	90 ohm	9.0(140 MHz ~ 1.0 GHz)	1.5	300	1.60x3.20x0.95	A
RFCMF1632100M3T	90 ohm	9.0(240 MHz ~ 1.0 GHz)	1.5	300	1.60x3.20x1.00	A

■ **TYPICAL ELECTRICAL CHARACTERISTICS**

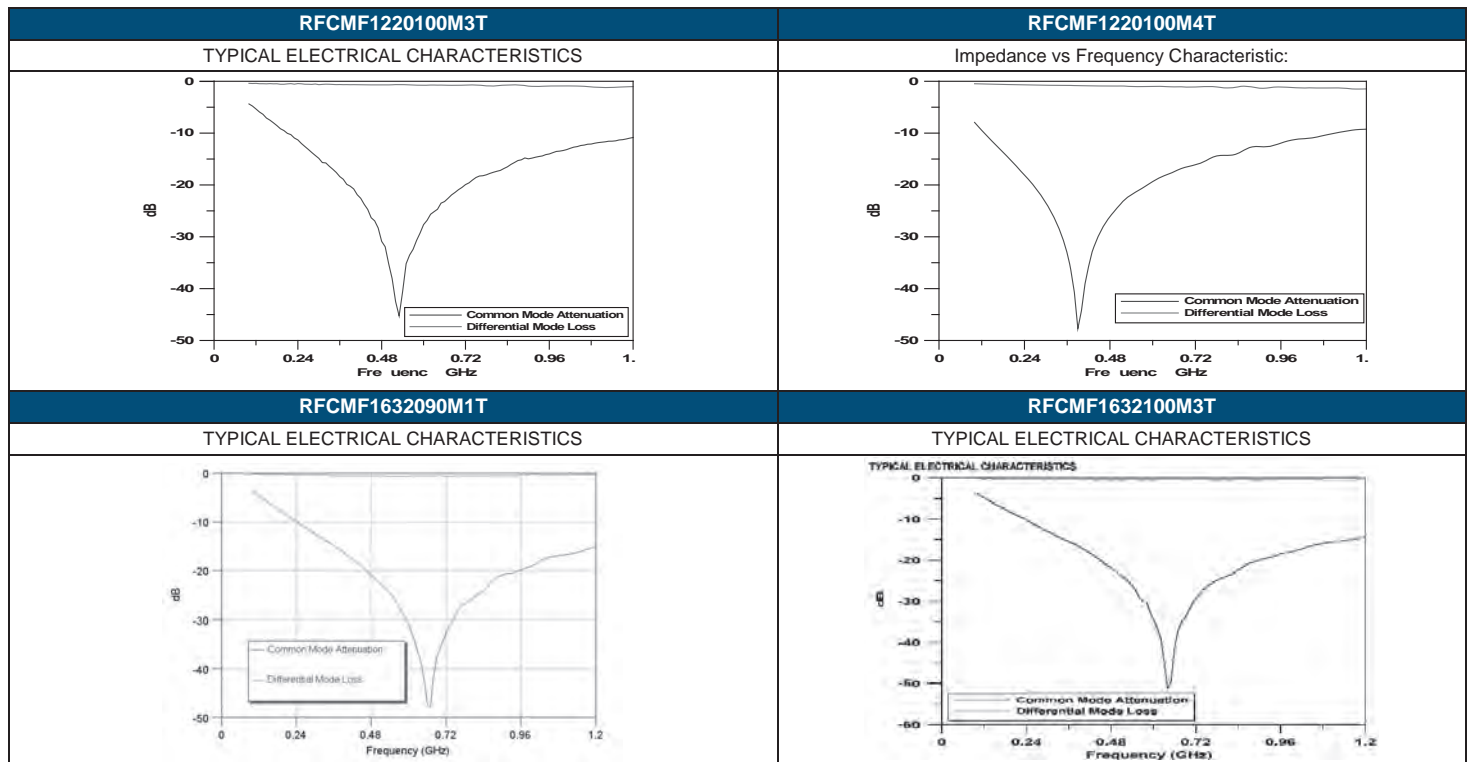

- For more information, please contact with local sales representative
- All specifications are subject to change without notice

COUPLER

■ **STRUCTURE AND PIN ASSOCIATED**

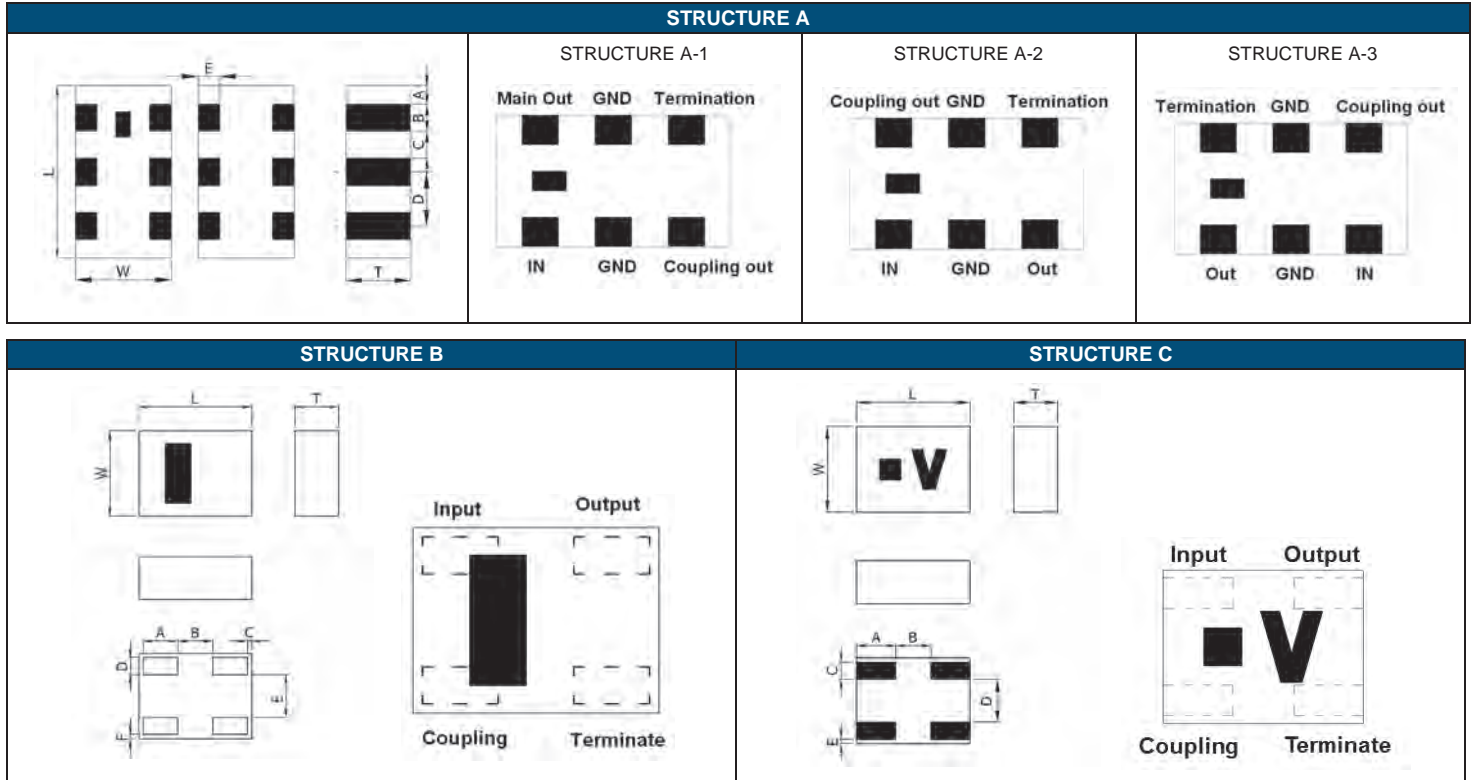

■ **STRUCTURE AND DIMENSION**

Unit: mm

Structure\ Dimension	L	W	T	A	B	C	D	E	F
A	1.60±0.10	0.80±0.10	0.60±0.10	0.10±0.10	0.30±0.10	0.25±0.10	0.55±0.10	0.20±0.10	-
	1.60±0.10	0.80±0.10	0.60±0.10	0.175±0.10	0.25±0.10	0.25±0.10	0.50±0.10	0.20±0.10	-
B	0.65±0.04	0.50±0.04	0.35±0.10	0.20±0.04	0.20±0.04	0.025±0.025	0.10±0.04	0.25±0.04	0.025±0.025
C	0.65±0.10	0.50±0.10	0.35±0.05	0.225±0.10	0.20±0.05	0.10±0.05	0.25±0.05	0.025±0.025	-

■ **ELECTRICAL SPECIFICATION**

ISM Band 2.4GHz Application

Part Number	Frequency (MHz)	Insertion Loss (dB)	Coupling in BW	Directivity in BW dB (min.)	Isolation in BW dB (min.)	VSWR	Dimension (mm ³)	Structure
RFCPL1806B2450T	2400-2500	1.83	6.5 ± 1.0 dB	-	21.0 dB min	1.5	1.60x1.80x0.60	A-1
RFCPL1810B2450T	2400-2500	0.74	10.0 ± 1.0 dB	-	22.0 dB min	1.8	1.60x1.80x0.60	A-1
TFCPL0605B24508Q1C	2400-2500	0.32(25°C) 0.40(-40~+85°C)	14.6 ± 1.0 dB	20.0 dB min.	-	1.3	0.60x0.50x0.35	B

ISM Band 2.4/5GHz Application

Part Number	Frequency (MHz)	Insertion Loss (dB)	Coupling in BW	Directivity in BW dB (min.)	Isolation in BW dB (min.)	VSWR	Dimension (mm ³)	Structure
TFCPL0605030L18A1U	2400-2500	0.5	19.0±1.5dB	15 dB min.	-	1.3	0.65x0.50x0.35	B
	4900-5850	0.5	12.5±1.5dB	15 dB min.	-	1.3		
TFCPL0605030L28Q1C	2400-2500	0.2	19.3±0.7dB	15 dB min.	-	1.3	0.65x0.50x0.35	B
	5150-5850	0.5	13.0±1.5dB	15 dB min.	-	1.3		
RFCPL0605030L58Q1C	2400-2500	0.3	19.0±1.5dB	14.5 dB min.	-	1.3	0.65x0.50x0.35	C
	4900-5850	0.6	13.0±2.0dB	13.5dB min.	-	1.8		

ISM Band 2.4/5GHz Application

Part Number	Frequency (MHz)	Insertion Loss (dB)	Coupling in BW	Directivity in BW dB (min.)	Isolation in BW dB (min.)	VSWR	Dimension (mm ³)	Structure
RFCPL0605030L6T	2400-2500	0.40(25°C) 0.45(-40~+85°C)	21.5±1.5dB	15 dB min.	-	1.3	0.65x0.50x0.35	C
	4900-5850	0.40(25°C) 0.45(-40~+85°C)	15.0±1.5dB	15 dB min.	-	1.3		
RFCPL0605030L9T	2400-2500	0.20(25°C) 0.25(-40~+85°C)	19.3±0.7dB	15 dB min.	-	1.3	0.65x0.50x0.35	C
	4900-5850	0.50(25°C) 0.55(-40~+85°C)	13.0±1.5dB	15 dB min.	-	1.3		
RFCPL0605030LFT	2400-2500	0.22(25°C) 0.24(-40~+85°C)	21.5±1.0dB	14 dB min.	-	1.3	0.65x0.50x0.35	C
	4900-5850	0.32(25°C) 0.35(-40~+85°C)	15.0±1.2dB	14 dB min.	-	1.3		
RFCPL0605030LHT	2400-2500	0.40(25°C) 0.45(-40~+85°C)	21.5±1.5dB	15 dB min.	-	1.3	0.65x0.50x0.35	C
	4900-5850	0.40(25°C) 0.45(-40~+85°C)	15.0±1.5dB	15 dB min.	-	1.3		

LTE BAND APPLICATION

Part Number	Frequency (MHz)	Insertion Loss (dB)	Coupling in BW	Directivity in BW dB (min.)	Isolation in BW dB (min.)	VSWR	Dimension (mm ³)	Structure
RFCPL1608070P08Q1C	698-2690	0.20(698-960MHz) 0.22(1427.9-2170MHz) 0.25(2300-2690MHz)	23.0-27.0(698-915MHz) 21.5-26.5(1427.9-2025MHz) 22.5-27.5(2300-2620MHz)	20.	-	1.5	1.60x1.80x0.60	A-2
RFCPL1608070P28Q1C	698-2690	0.20(698-960MHz) 0.22(1427.9-2170MHz) 0.25(2300-2690MHz)	23.0-27.0(698-915MHz) 21.5-26.5(1427.9-2025MHz) 22.5-27.5(2300-2620MHz)	20	-	1.5	1.60x1.80x0.60	A-2
RFCPL1608070P38Q1C	698-2690	0.20(698-960MHz) 0.22(1710-2170MHz) 0.25(2300-2690MHz)	23.0-27.0(698-915MHz) 21.5-26.5(1710-2025MHz) 22.5-27.5(2300-2620MHz)	20	-	1.45	1.60x1.80x0.60	A-3
RFCPL1608070PM9T16	700-2700	0.2(700-790MHz) (Typ.0.07) 0.2(820-900MHz) (Typ.0.07) 0.3(1701-2100MHz) (Typ.0.15) 0.3(2300-2700MHz) (Typ.0.15)	24-27(700-790MHz) 24-27(820-900MHz) 20-23(1701-2100MHz) 20-23(2300-2700MHz)	-	40(700-790MHz) 40(820-900MHz) 35(1701-2100MHz)) 35(2300-2700MHz))	1.45	1.60x1.80x0.60	A-1

■ TYPICAL ELECTRICAL CHARACTERISTICS

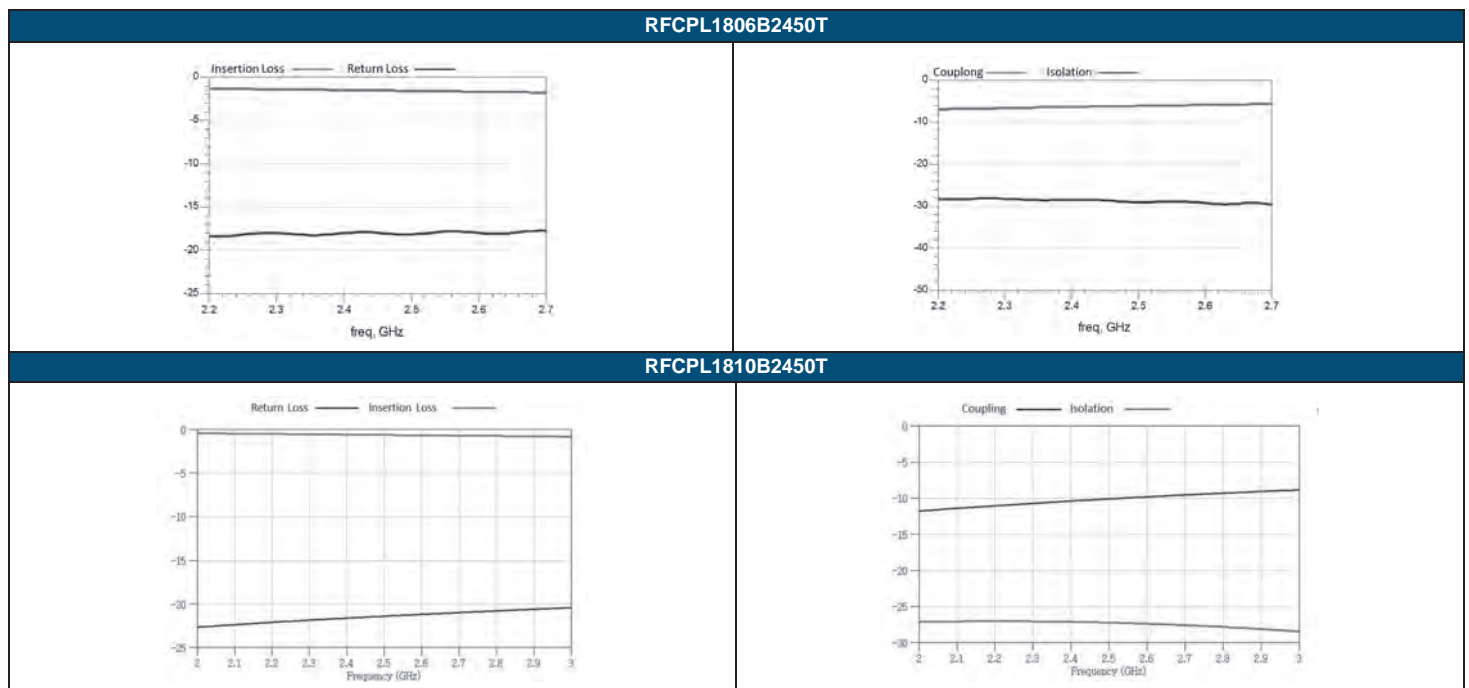

TYPICAL ELECTRICAL CHARACTERISTICS

TFCPL0605B24508Q1C

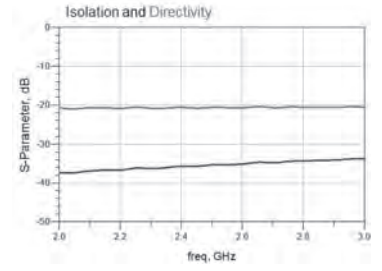
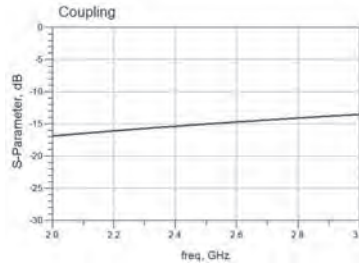

FCPL0605030L28Q1C

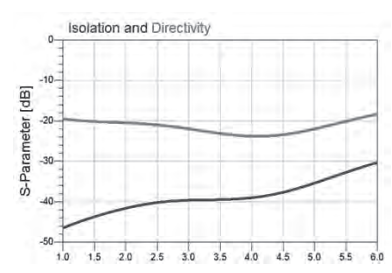
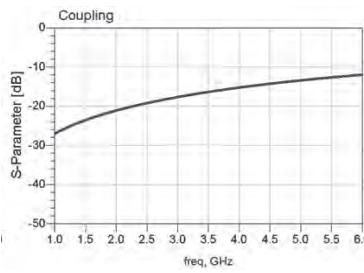
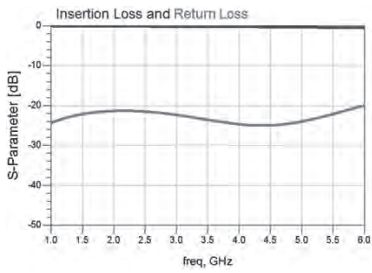

TFCPL0605030L28Q1C

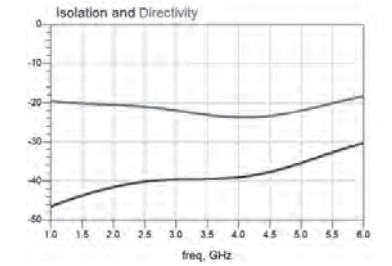
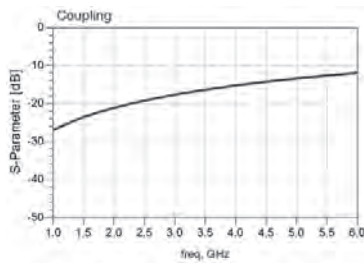
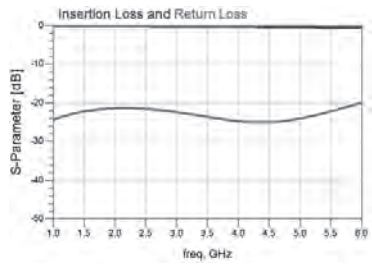

RFCPL0605030L58Q1C

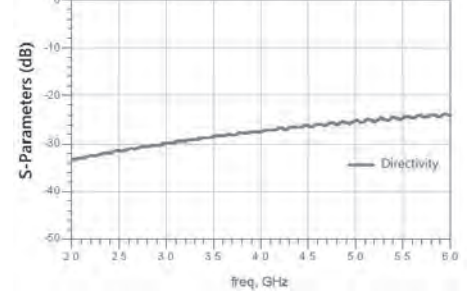
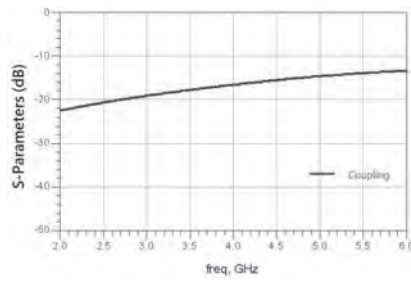
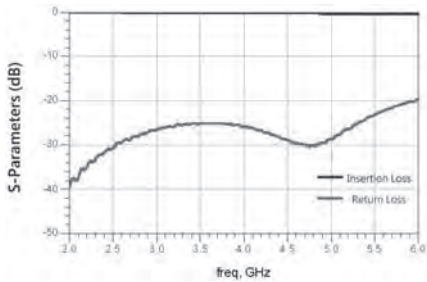

RFCPL0605030L6T

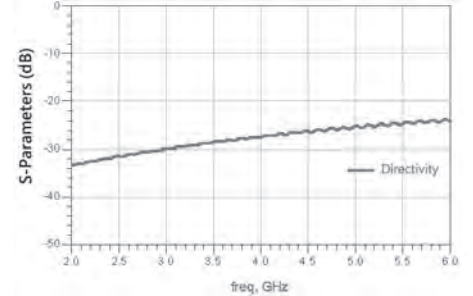
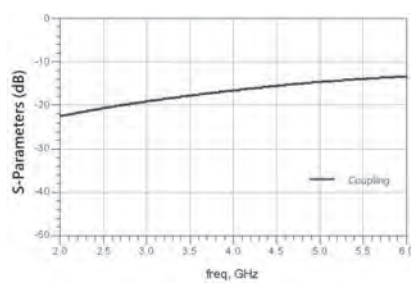
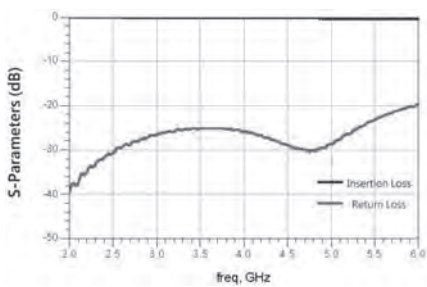

TYPICAL ELECTRICAL CHARACTERISTICS

RFCPL0605030L9T

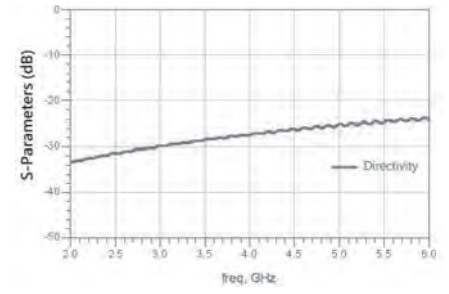
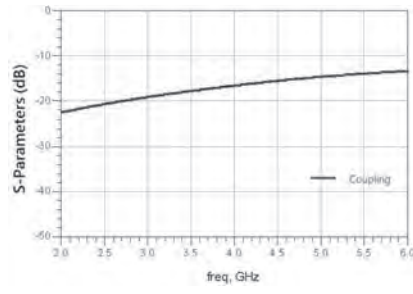
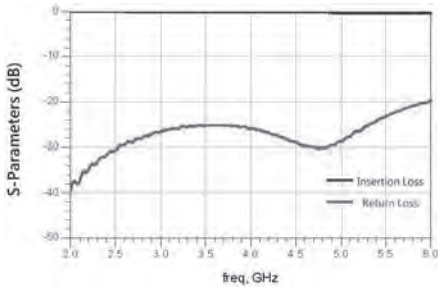

RFCPL0605030LFT

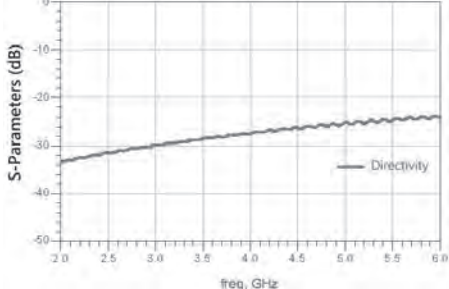
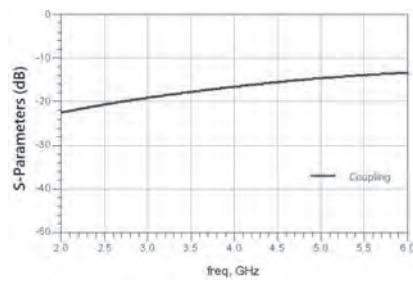
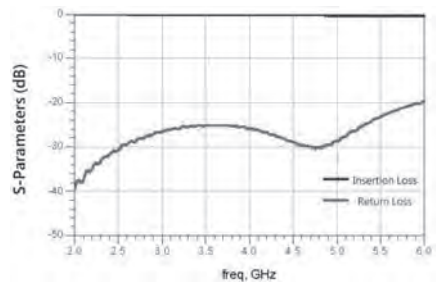

RFCPL0605030LHT

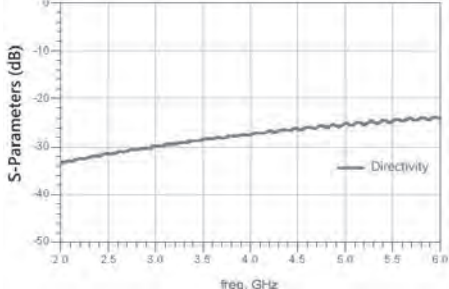
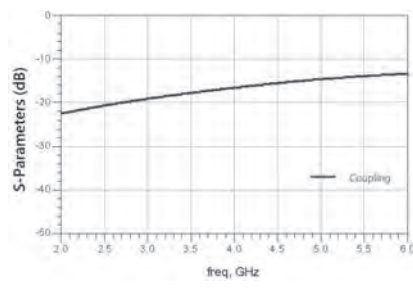
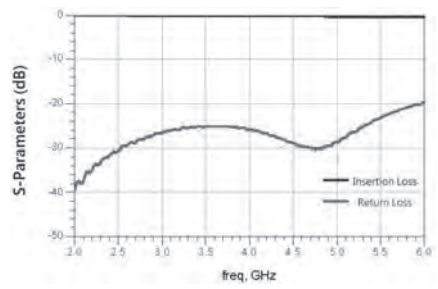

RFCL1608070P08Q1C

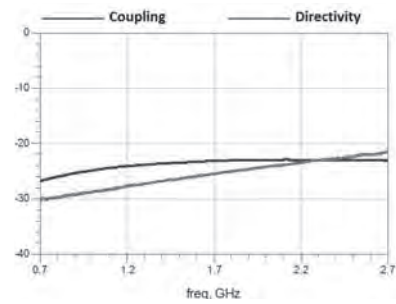
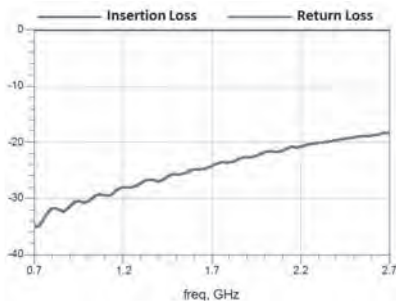

RFCL1608070P28Q1C

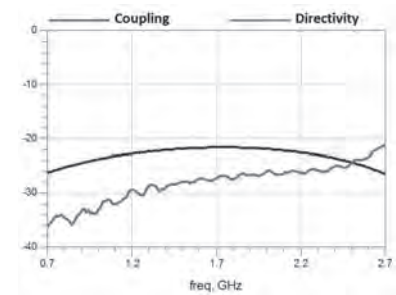
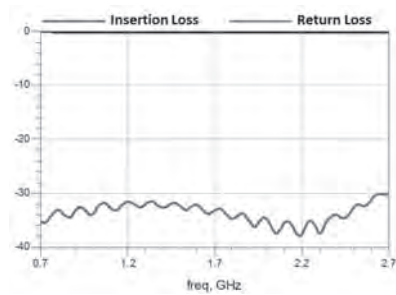

TYPICAL ELECTRICAL CHARACTERISTICS

RFCPL1608070P38Q1C

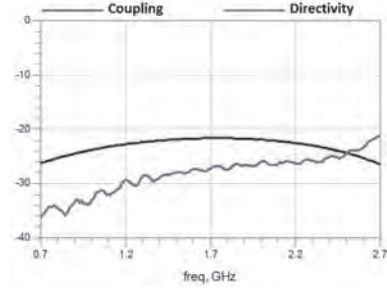
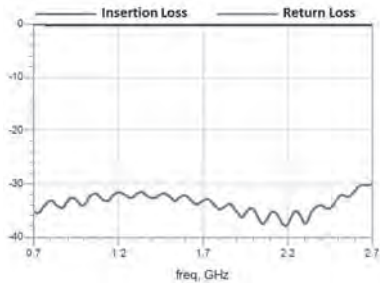

RFCPL1608070PHT

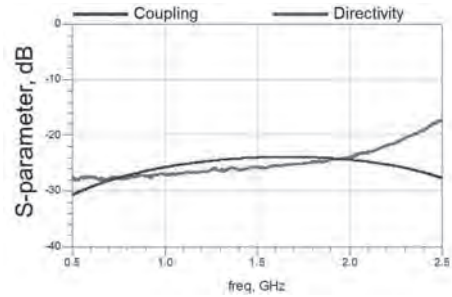
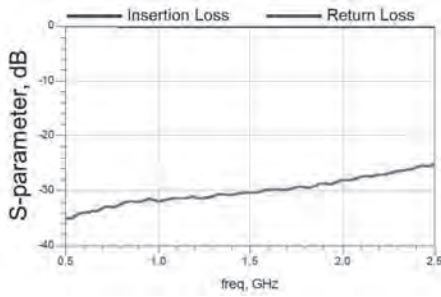

RFCPL1608070PKT

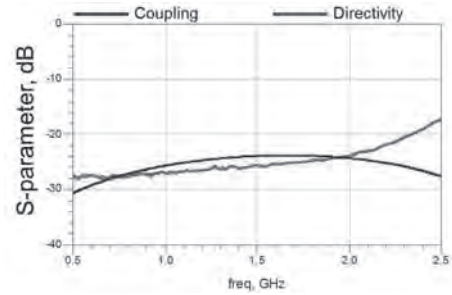
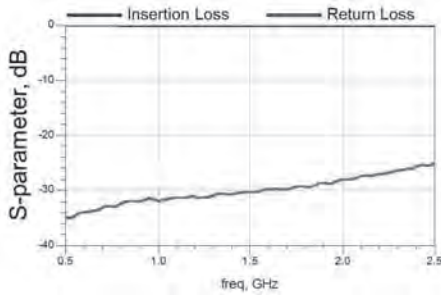

RFCPL1608070PM9T16

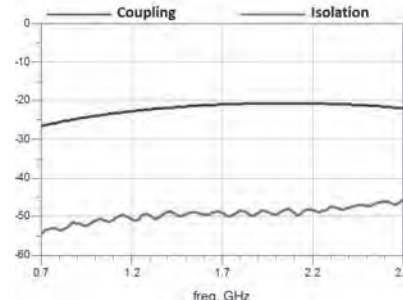
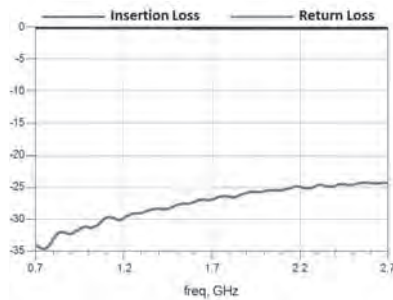

- For more information, please contact with local sales representative
- All specifications are subject to change without notice

SAW Filter

■ STRUCTURE AND PIN ASSOCIATED

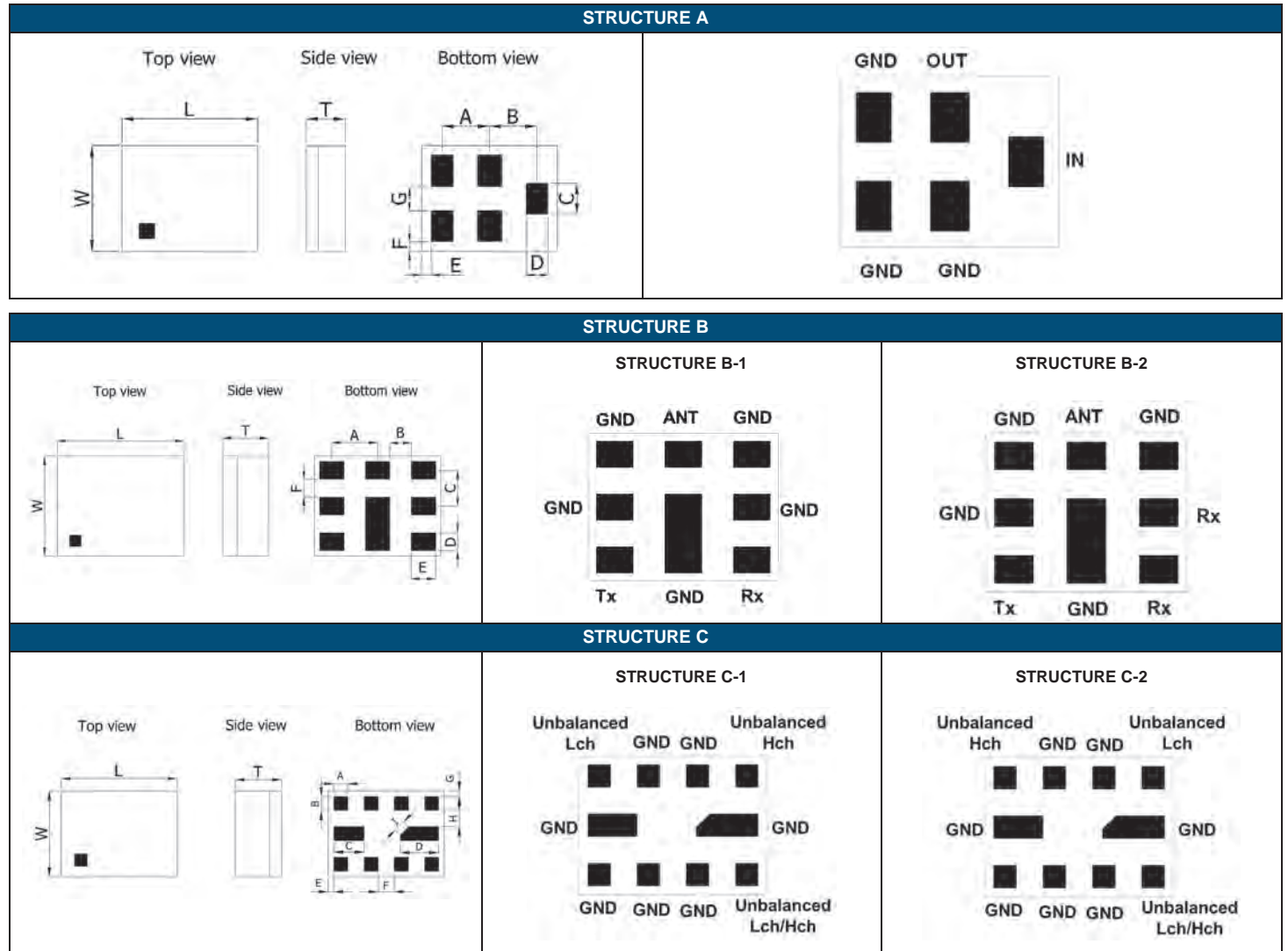

■ STRUCTURE AND DIMENSION

Unit: mm

Structure Dimension	L	W	T	A	B	C	D	E	F	G	H	I
A	1.10±0.10	0.90±0.10	0.50max.	0.40	0.40	0.25	0.20	0.05	0.075	0.25	-	-
	1.40±0.13	1.10±0.13	0.65max.	0.50	0.50	0.325	0.25	0.075	0.10	0.25	-	-
B	1.80±0.10	1.40±0.10	0.65max.	0.65	0.30	0.50	0.25	0.35	0.25	-	-	-
C	1.50±0.10	1.10±0.10	0.60max.	0.18	0.18	0.39	0.49	0.075	0.21	0.07	0.21	0.15

■ **ELECTRICAL SPECIFICATION**

Application	Type	Part Number	Band	Frequency(MHz)	Package (mm)	STRUCTURE
GPS/Wifi	GPS SAW 3 Mode	SF11091582GC2T	GPS+G+C	1559.05-1605.89	1.1 x 0.9	A
	GPS SAW 3 Mode	SF14111582GC01T	GPS+G+C	1559.05-1605.66	1.4 x 1.1	A
	SAW	SF11092450A04T	WLAN	2400-2500	1.1 x 0.9	A
	SAW	SF14112450A03T	WLAN	2400-2500	1.4 x 1.1	A
	SAW	SF14112442A01T	WLAN	2400-2484	1.4 x 1.1	A
	SAW	SF14112442A03T	WLAN	2401-2483	1.4 x 1.1	A
FDD LTE	SAW Duplexer	DF18141950B104T	B1	1920-1980/2110-2170	1.8 x 1.4	B-1
	SAW Duplexer	DF18140836B511T	B5	824-849/869-894	1.8 x 1.4	B-1
	SAW Duplexer	DF18141880B203T	B2	1850.48-1909.52/1930.48-1989.52	1.8 x 1.4	B-1
	SAW Duplexer	DF18141747B303T	B3	1712.5-1782.5/1807.5-1877.5	1.8 x 1.4	B-1
	SAW Duplexer	DF18142535B705T	B7	2500-2570/2620-2690	1.8 x 1.4	B-1
	SAW Duplexer	DB18142140B102T	B1	1920-1980/2110-2170	1.8 x 1.4	B-2
	SAW Duplexer	DB18140881B507T	B5	824-849/869-894	1.8 x 1.4	B-2
	SAW Duplexer	DB18140942B801T	B8	880-915/925-960	1.8 x 1.4	B-2
FDD LTE	RX SAW	SF11092140B102T	B1	2110-2170	1.1 x 0.9	A
	RX SAW	SF11091960B201T	B2	1930-1990	1.1 x 0.9	A
	RX SAW	SF11091842B305T	B3	1805-1880	1.1 x 0.9	A
	RX SAW	SF11090881B506T	B5	869-894	1.1 x 0.9	A
	RX SAW	SF11092655B702T	B7	2620-2690	1.1 x 0.9	A
	RX SAW	SF11090942B805T	B8	925-960	1.1 x 0.9	A
TDD LTE	Rx Dual SAW	BF1511B394101AT	B39/B41	1880-1920/2550-2655	1.5 x 1.1	C-2
	Rx Dual SAW	BF1511B394101BT	B39/B41	1880-1920/2550-2655	1.5 x 1.1	C-1
TDD LTE	TRx SAW	SF14112595B3803T	B38	2570-2620	1.4 x 1.1	A
	TRx SAW	SF14112350B4001T	B40	2300-2400	1.4 x 1.1	A
	TRx SAW	SF14112605B41S4T	B41	2550-2655	1.4 x 1.1	A
	TRx SAW	SF14112593B4102T	B41	2496-2690	1.4 x 1.1	A
	TRx SAW	SF14112017B3402T	B34	2010-2025	1.4 x 1.1	A
	TRx SAW	SF14111900B3906T	B39	1880-1920	1.4 x 1.1	A
	TRx SAW	SF11092595B3804T	B38	2570-2620	1.1 x 0.9	A
	TRx SAW	SF11092350B4004T	B40	2300-2400	1.1 x 0.9	A
	TRx SAW	SF11092595B4108T	B41	2535-2655	1.1 x 0.9	A
	TRx SAW	SF11092017B3403T	B34	2010-2025	1.1 x 0.9	A
	TRx SAW	SF11091900B3907T	B39	1880-1920	1.1 x 0.9	A
TDD LTE	Rx SAW	SF11092595B3805T	B38	2570-2620	1.1 x 0.9	A
	Rx SAW	SF11092350B4005T	B40	2300-2400	1.1 x 0.9	A
	Rx SAW	SF11092602B41W9T	B41	2550-2655	1.1 x 0.9	A

■ **TYPICAL ELECTRICAL CHARACTERISTICS**

SF11091582GC2T

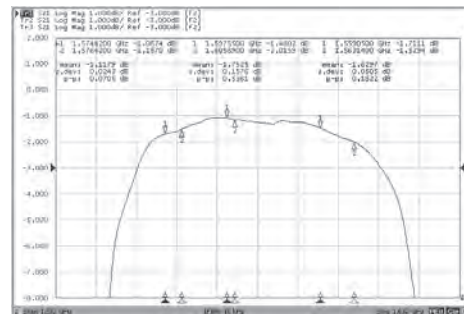

TYPICAL ELECTRICAL CHARACTERISTICS

SF14111582GC01T

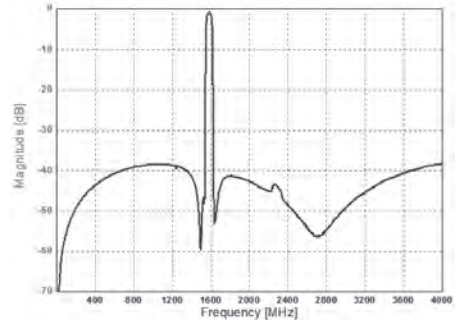
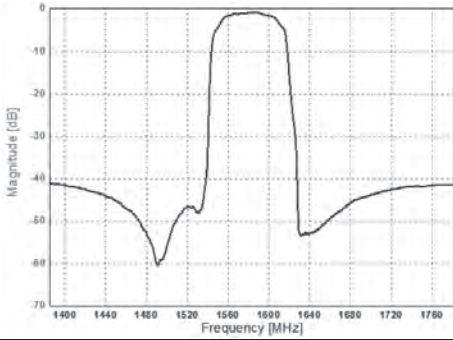

SF11092450A04T

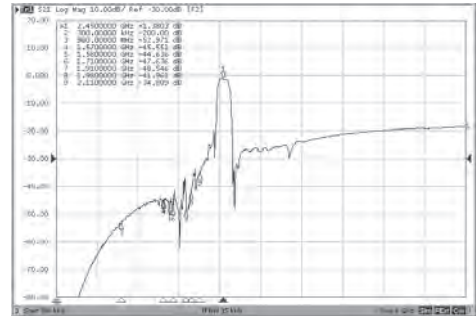
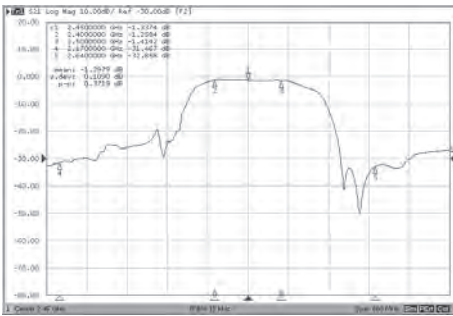

SF14112450A03T

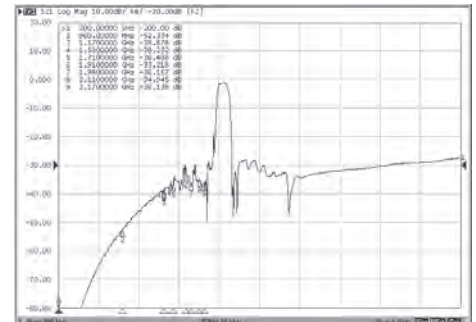
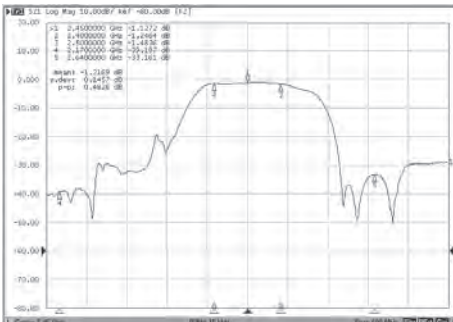

SF14112442A01T

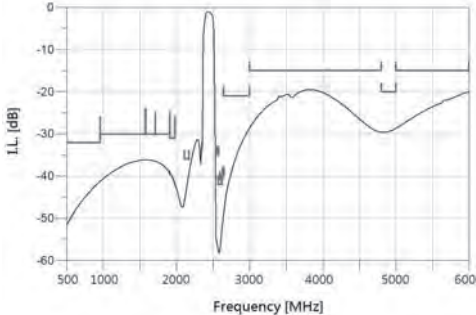
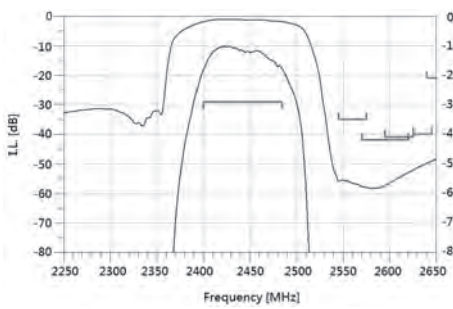

SF14112442A03T

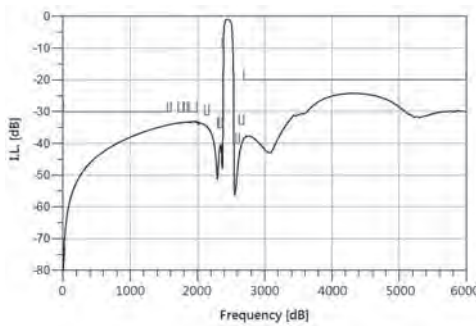
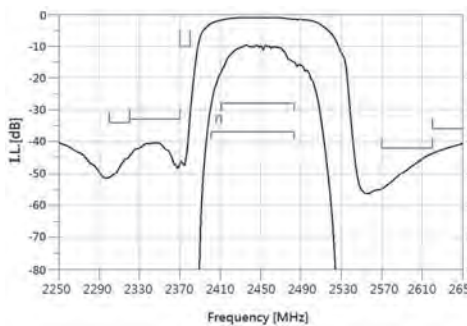

TYPICAL ELECTRICAL CHARACTERISTICS

DF18141950B104T

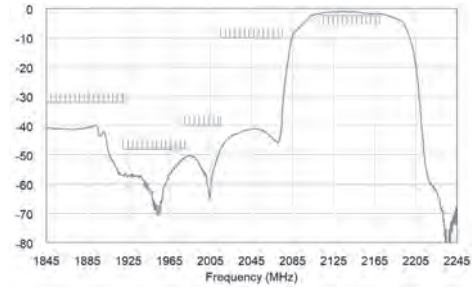
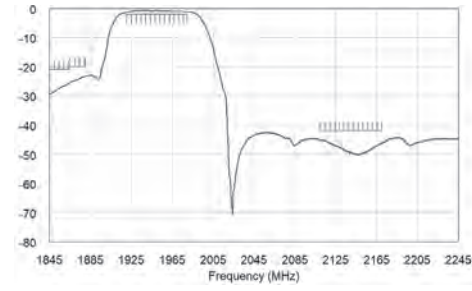

DF18140836B511T

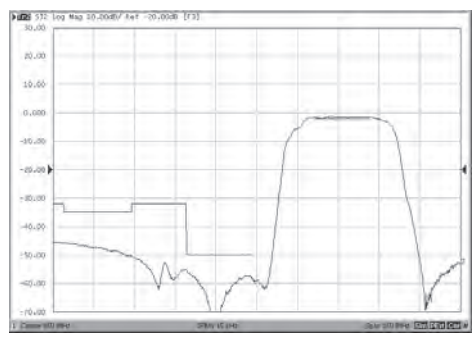
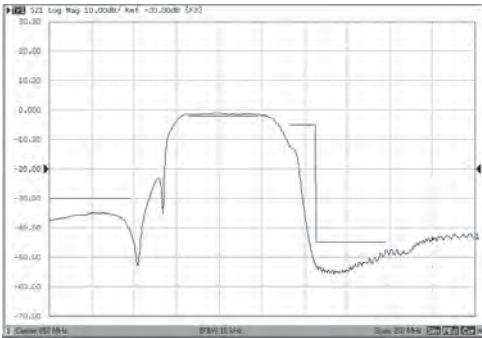

DF18141880B203T

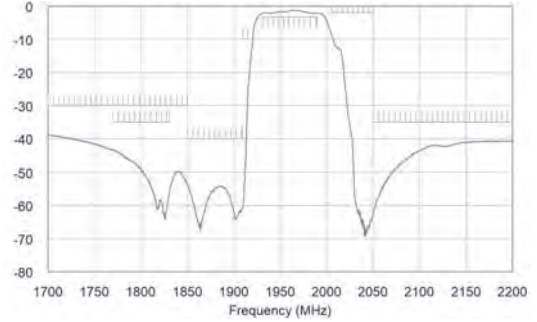
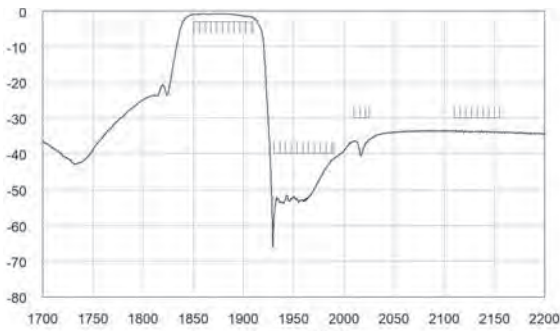

DF18141747B303T

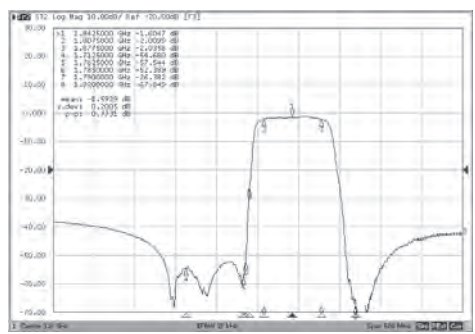

DF18142535B705T

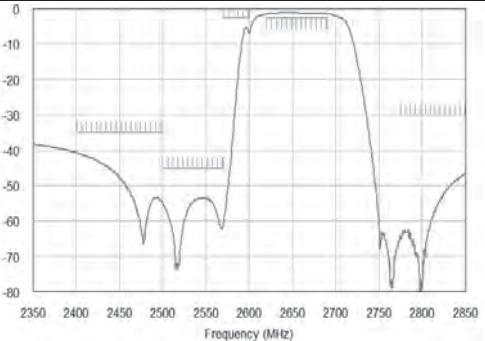
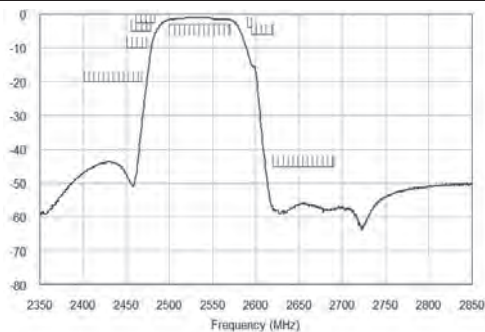

TYPICAL ELECTRICAL CHARACTERISTICS

DB18142140B102T

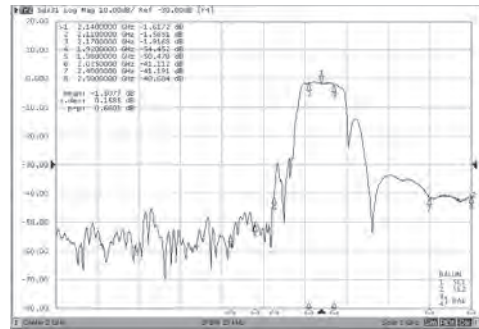
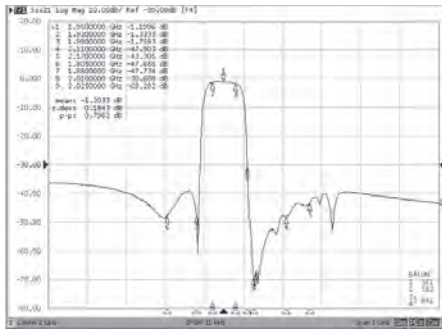

DB18140881B507T

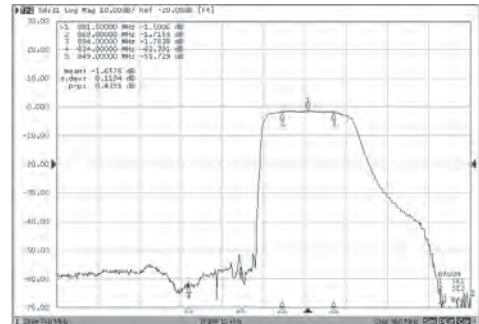
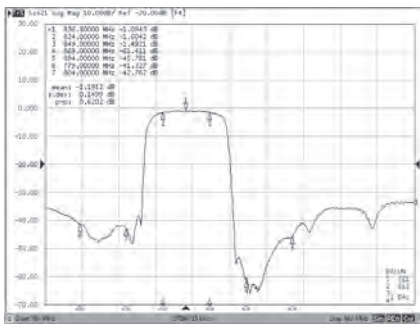

DB18140942B801T

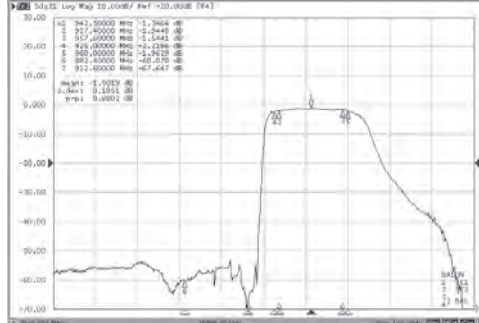
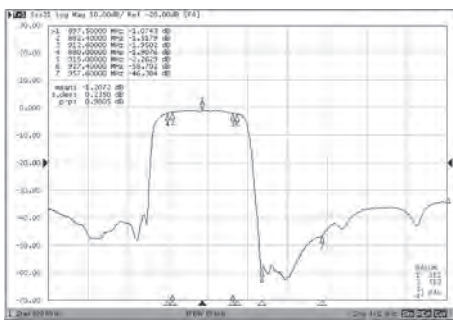

SF11092140B102T

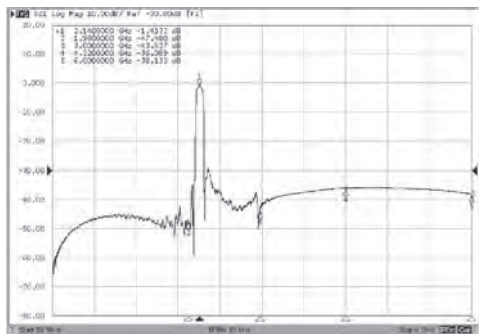
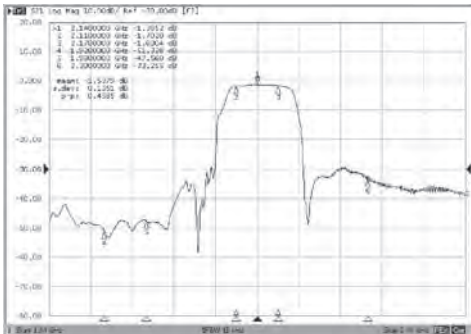

SF11091960B201T

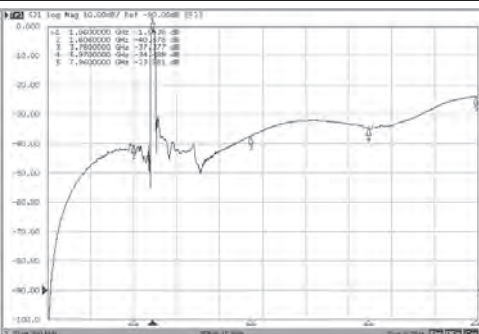
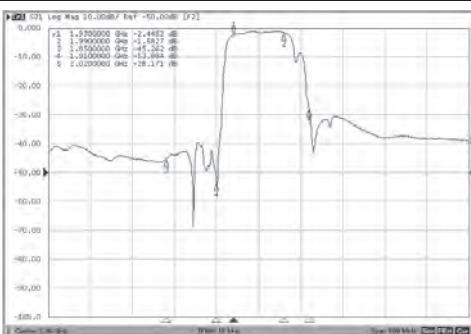

TYPICAL ELECTRICAL CHARACTERISTICS

SF11091842B305T

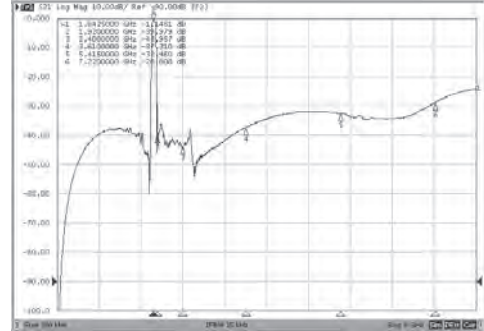
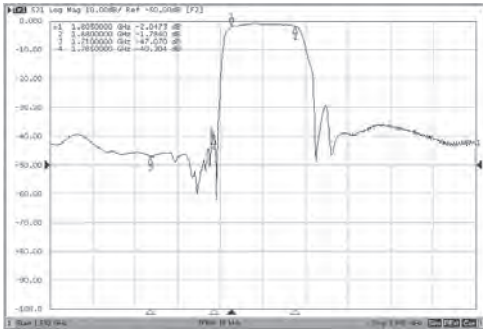

SF11090881B506T

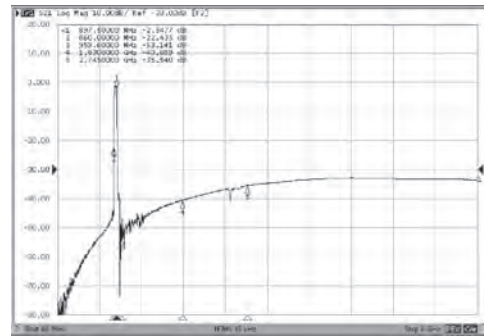
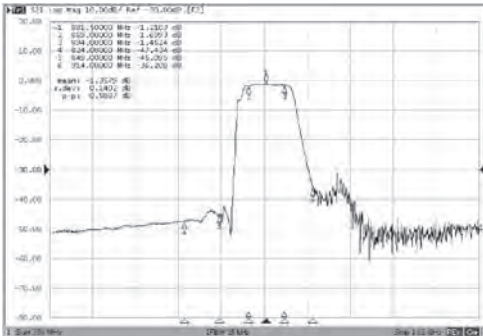

SF11092655B702T

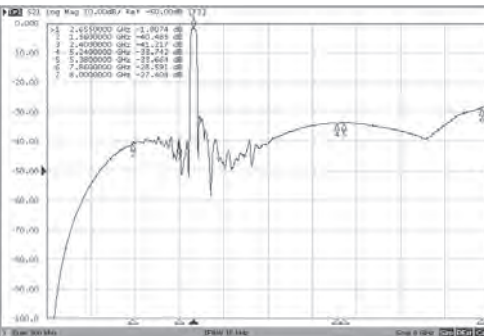
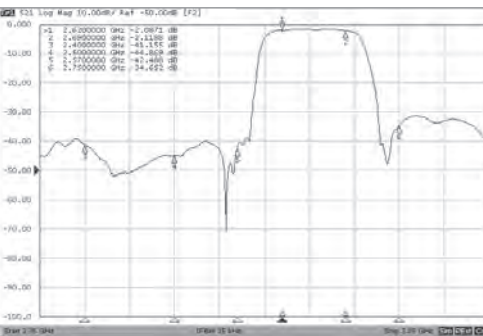

SF11090942B805T

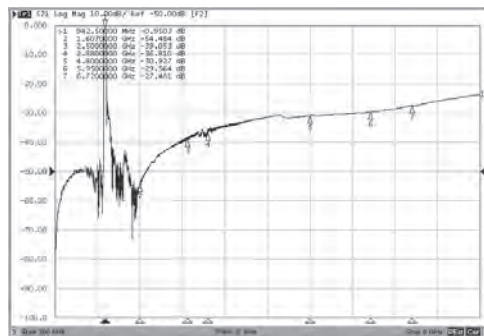
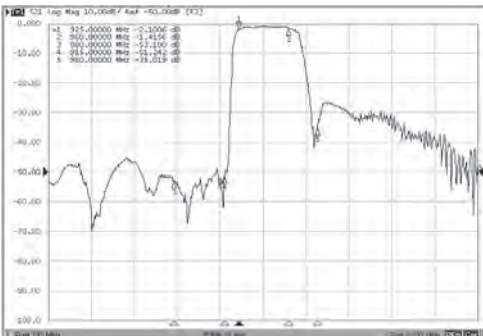

SF14112595B3803T

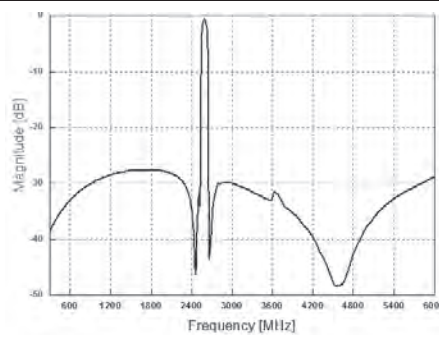
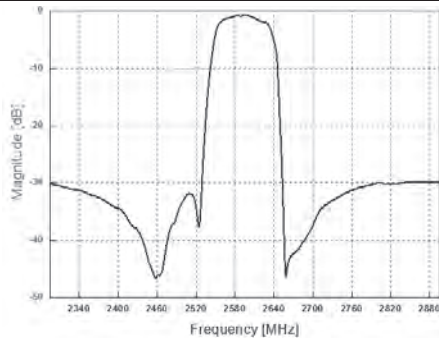

TYPICAL ELECTRICAL CHARACTERISTICS

SF14112350B4001T

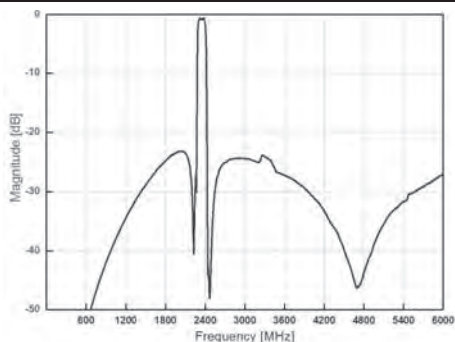
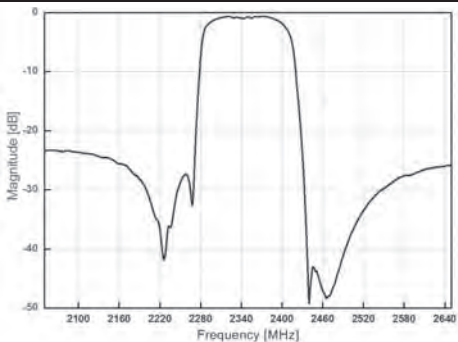

SF14112605B41S4T

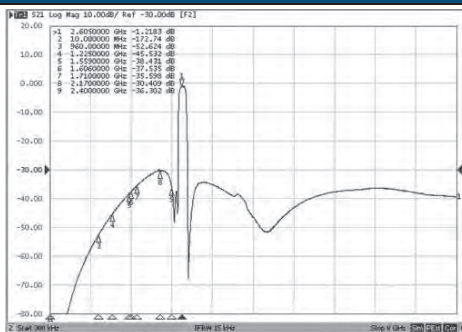
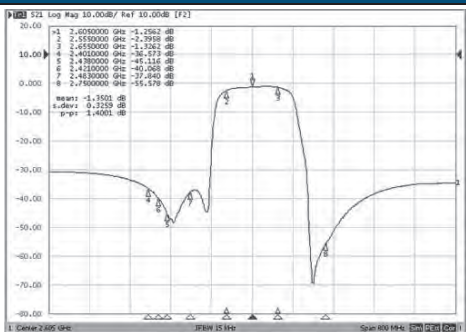

SF14112593B4102T

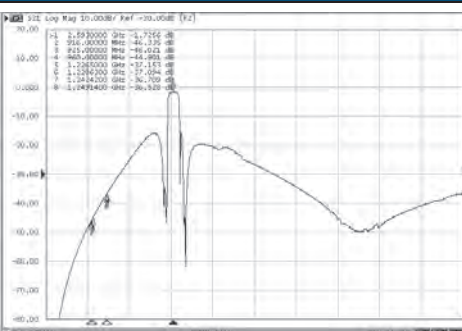

SF14112017B3402T

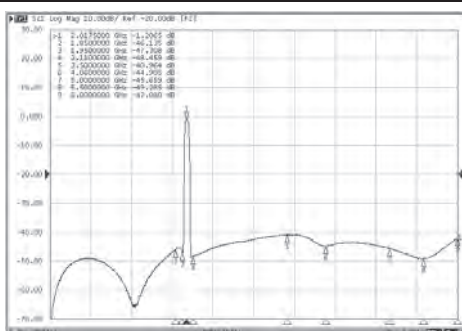
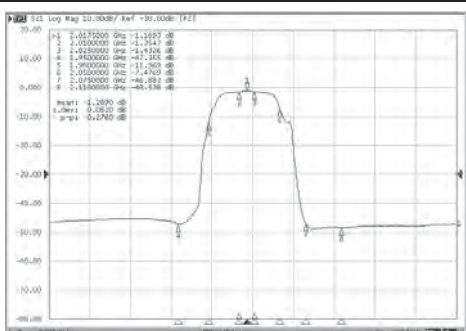

SF14111900B3906T

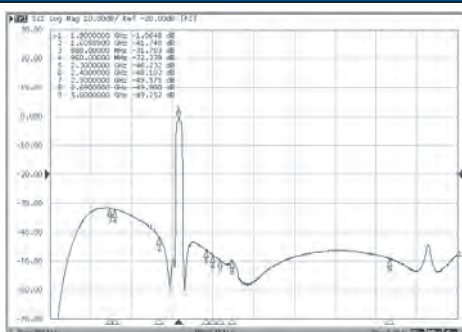
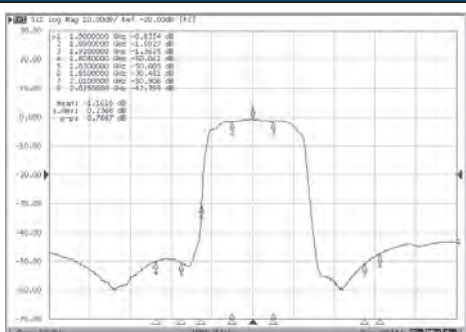

TYPICAL ELECTRICAL CHARACTERISTICS

SF11092595B3804T

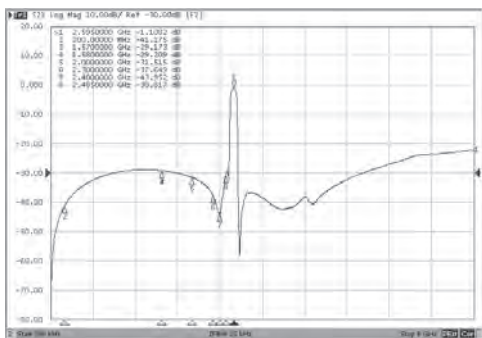

SF11092350B4004T

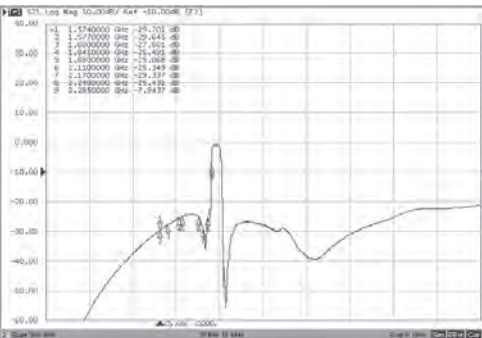
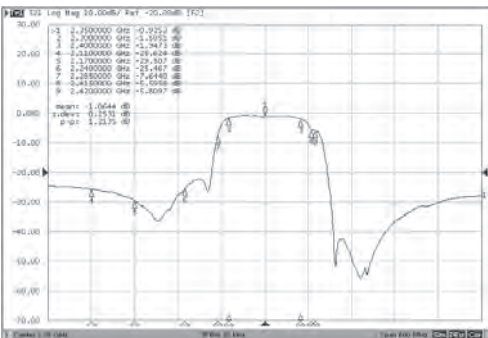

SF11092595B4108T

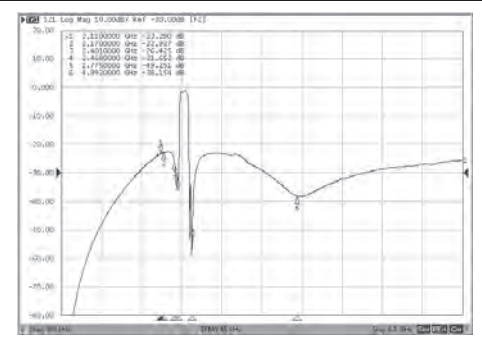
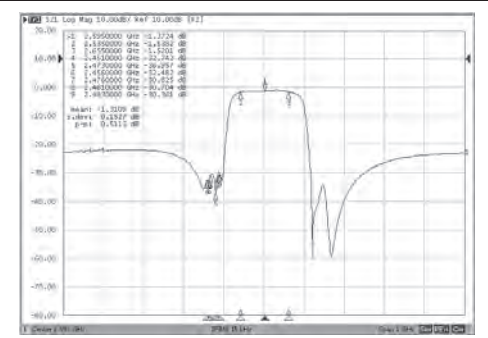

SF11092017B3403T

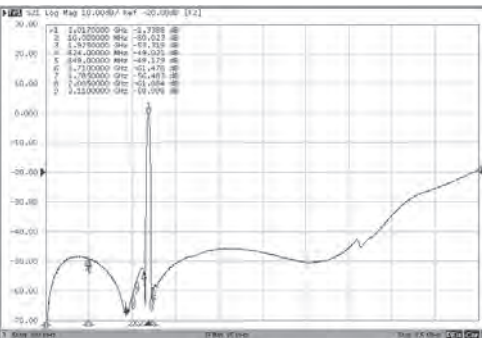
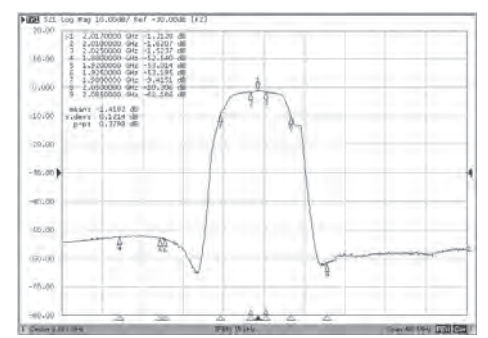

SF11091900B3907T

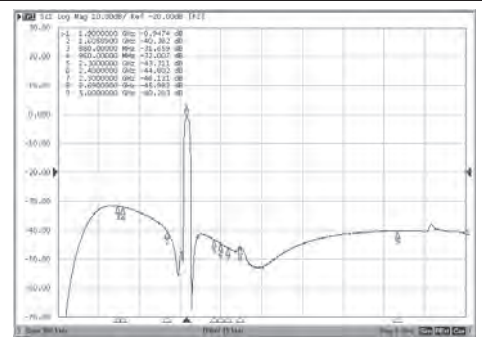
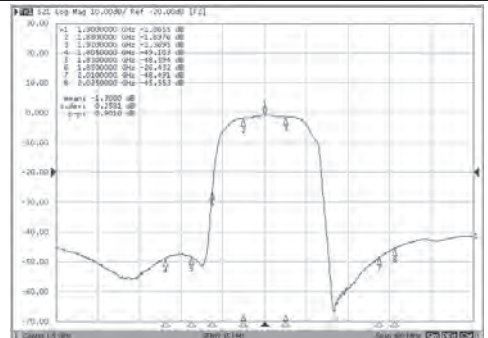

TYPICAL ELECTRICAL CHARACTERISTICS

SF11092595B3805T

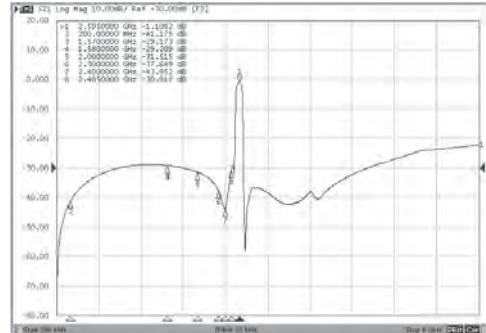

SF11092350B4005T

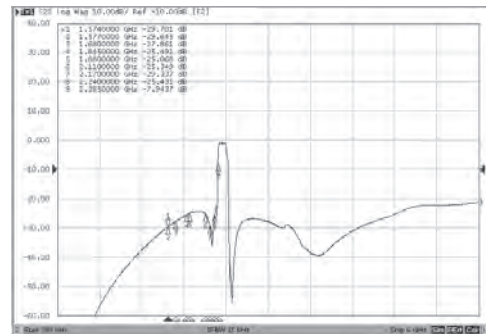
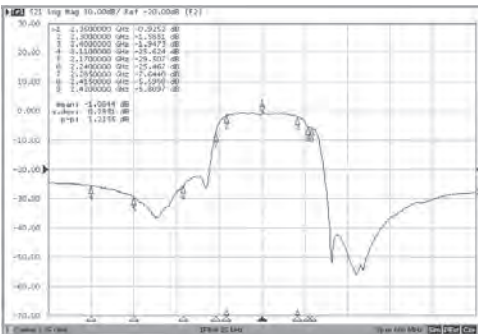

SF11092602B41W9T

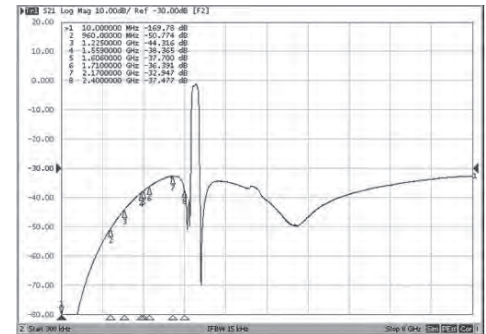
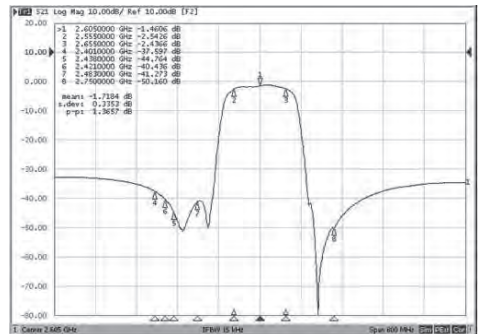

- For more information, please contact with local sales representative
- All specifications are subject to change without notice

ANTENNA SWITCH

■ **Application Circuit (GPIO)**

<p>RFASWA630PTF06</p> <p>SPDT</p>	<p>RFASWA697ATF09</p> <p>SPDT</p>	<p>RFASWAM3489ATF09</p> <p>SPDT</p>
<p>RFASWMT2628PTF09</p> <p>SP3T</p>	<p>RFASWMT2628BTF09</p> <p>SP3T</p>	<p>RFASWMH6373ATF09</p> <p>SP3T</p>
<p>RFASWKH4414PTF06</p> <p>SP4T</p>	<p>RFASWK626ATF09</p> <p>SP4T</p>	<p>RFASWHH1416PTF06</p> <p>SP6T</p>
<p>RFASWDH2418PTF06</p> <p>SP8T</p>		

ANTENNA SWITCH

■ **Application Circuit (GPIO)**

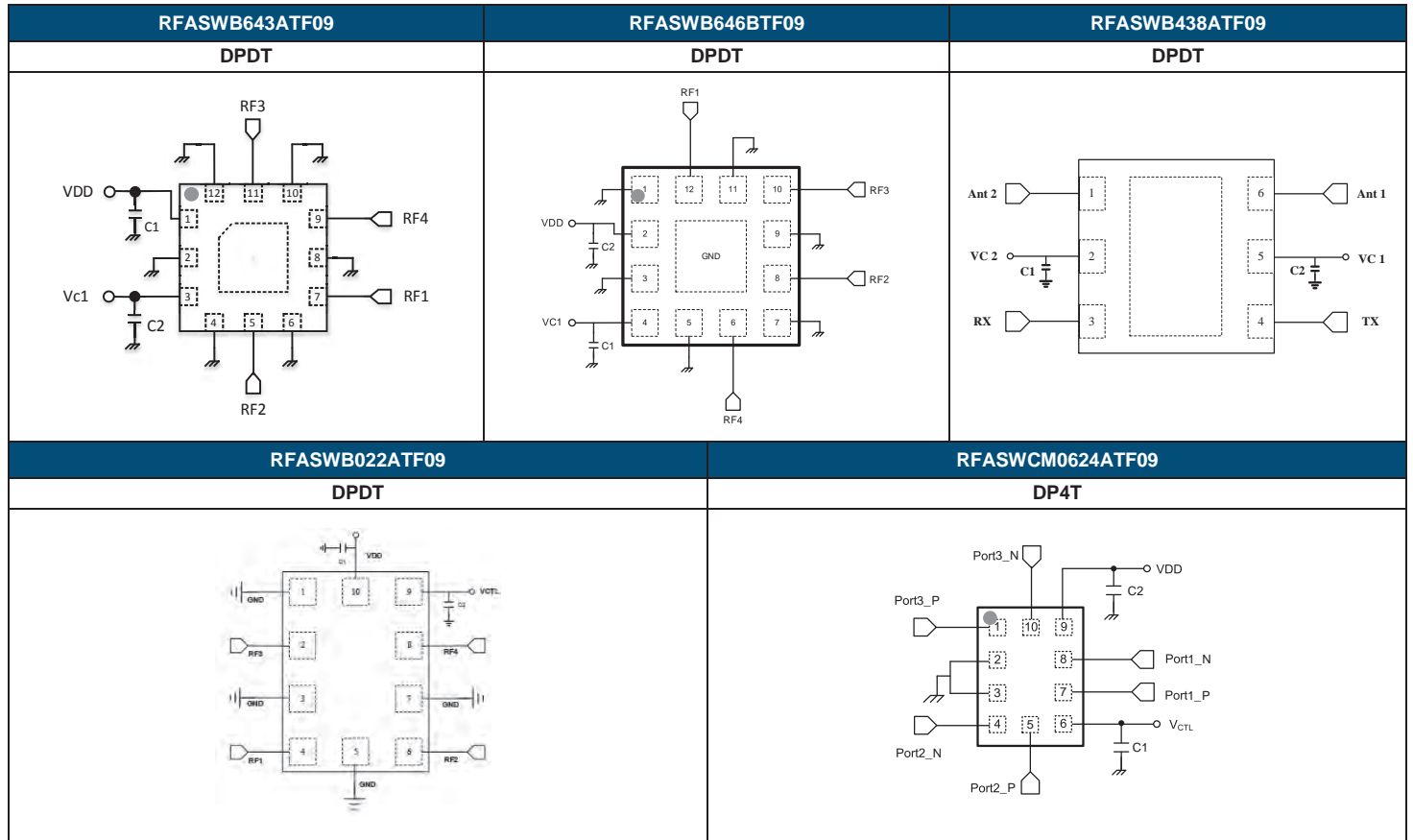

■ **ELECTRICAL SPECIFICATION**

Part Number	Description	Frequency (GHz) Min.	Frequency (GHz) Max.	Insertion loss	Isolation	VSWR	Package (mm)
				(dB)	(dB)		
RFASWA630PTF06	SPDT	0.1	6	0.25~1.1dB	14~35	1.20	1.1 x 0.7
RFASWA697ATF09		0.4	6	0.35~1.00dB	15~32	1.50	1.0 x 1.0
RFASWAM3489ATF09		0.7	2.7	0.38~0.50dB	21~33	1.25	1.1 x 0.7
RFASWMT2628PTF09	SP3T	0.5	2.7	0.30~0.60dB	20~35	1.43	1.0 x 1.0
RFASWMT2628BTF09		0.8	2.7	0.30~0.70dB	14~26	1.50	1.0 x 1.0
RFASWMMH6373ATF09		0.5	6	0.32~0.80dB	15~32	1.40	2.0 x 2.0
RFASWKH4414PTF06	SP4T	0.1	2.7	0.45~0.65dB	24~38	1.22	2.0 x 2.0
RFASWK626ATF09		0.7	2.7	0.30~0.50dB	27~38	1.60	1.1 x 1.1
RFASWHH1416PTF06	SP6T	0.1	2.7	0.4~0.65dB	24~38	1.22	2.0 x 2.0
RFASWDH2418PTF06	SP8T	0.1	2.7	0.30~0.80dB	18~35	1.50	2.0 x 2.0
RFASWB643ATF09	DPDT	0.7	2.7	0.40~0.55dB	22~30	1.28	2.0 x 2.0
RFASWB646BTF09		0.7	3.8	0.40~0.70dB	25~33	1.20	1.83 x 1.83
RFASWB438ATF09		0.1	6	0.50~1.20dB	13~28	1.43	1.5 x 1.5
RFASWB022ATF09		0.6	6	0.40~1.05dB	16~33	1.30	1.1 x 1.5
RFASWCM0624ATF09	DP4T	0.824	0.96	0.25dB	28~38	1.50	1.1 x 1.5
		1.71	2.17	0.35dB	23~30	1.50	
		0.698	0.792	0.25dB	28~38	1.50	
		2.3	2.69	0.40dB	20~24	1.50	

■ **Application Circuit (MIPI)**

RFASWH526BTF03 SP6T	RFASWH656FTF03 SP6T	RFASWD658FTF03 SP8T
RMASME494ATF03 SP10T	RFASWE660DTF03 SP10T	RFASWF662DTF03 SP12T
RMASMF496ATF03 SP12T	RMASMP491ATF03 SP14T	RMASMT1492ATF03 SP16T
RMASMU532ATF03 DP14T (SP8T+SP6T)	RMASMU890ATF03 DP14T (SP7T+SP7T)	RMASMS535ATF03 DP21T (SP12T+SP9T)

■ **ELECTRICAL SPECIFICATION**

Part Number	Description	Frequency (GHz) Min.	Frequency (GHz) Max.	Insertion loss (dB) TRXx ports	Isolation (TRXx to any off TRXx port) [non-adjacent ports]	Isolation (TRXx to any off TRXx port) [adjacent ports]	VSWR	Package (mm)
RFASWH526BTF03	SP6T	0.4	2.7	0.40-0.76dB(400-2690MHz)	20-30	17-26	2	2.0 x 2.0
RFASWH656FTF03		0.4	2.7	0.40-0.76dB(704-2690MHz)	20-30	17-26	2	2.0 x 2.0
RFASWD658FTF03	SP8T	0.4	2.7	0.40-0.76dB(704-2690MHz)	20-30	17-26	2	2.0 x 2.0
RMASME494ATF03	SP10T	0.4	2.7	0.60-0.85dB(824-2690MHz)	23-30	20-26	2	2.5 x 2.5
RFASWE660DTF03		0.7	2.7	0.45-0.75dB(700-2700MHz)	18-26	18-26	2	2.4 x 2.4
RFASWF662DTF03	SP12T	0.4	2.7	0.50-0.72dB(700-2690MHz)	20-30	16-23	2	2.5 x 2.5
RMASMF496ATF03		0.4	2.7	0.60-0.85dB(824-2690MHz)	23-30	20-26	2	2.5 x 2.5
RMASMP491ATF03	SP14T	0.4	2.7	0.70-1.15dB(700-2690MHz)	20-30	16-20	2	2.5 x 2.9
RMASMNT1492ATF03	SP16T	0.4	2.7	0.60-1.00dB(824-2690MHz)	20-30	16-20	2	2.5 x 3.3
RMASMU532ATF03	DP14T (SP8T+SP6T)	0.4	2.7	0.65-1.15dB(704-2690MHz)	17-23	14-21	1.5	2.8 x 2.8
RMASMU890ATF03	DP14T (SP7T+SP7T)	0.4	2.7	0.60-0.85dB(600-2690MHz)	18-25	15-23	1.5	3.2 x 2.8
RMASMS535ATF03	DP21T (SP12T+SP9T)	0.7	3.0	0.65-1.10dB(824-2690MHz)	15-23	14-21	2	3.6 x 2.8

■ **Application Circuit (LTE Antenna Tuner-GPIO)**

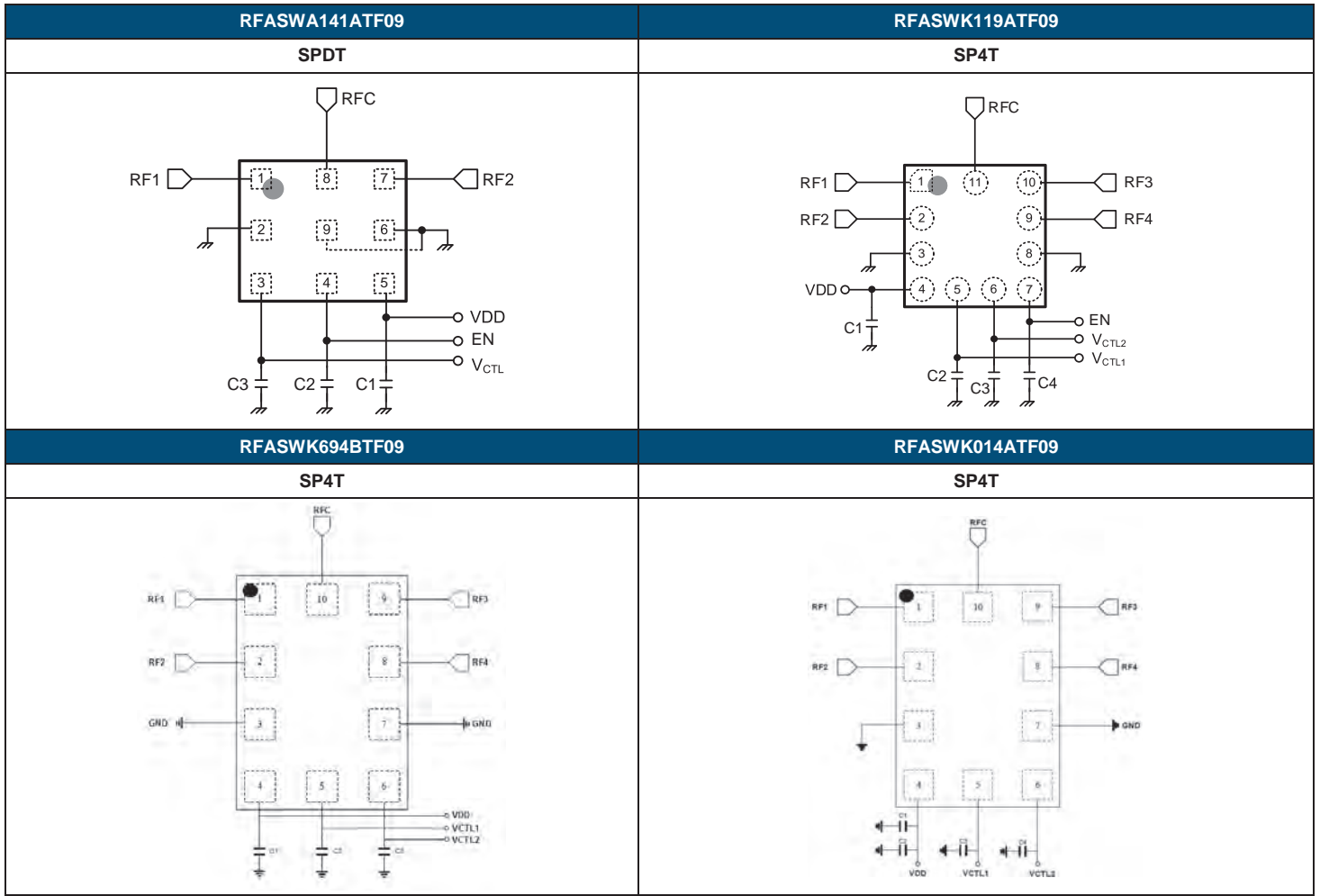

■ **ELECTRICAL SPECIFICATION**

Part Number	Description	Frequency (GHz) Min.	Frequency (GHz) Max.	Insertion loss (dB)	Isolation	VSWR	Package (mm)
RFASWA141ATF09	SPDT	0.4	3.0	0.20-0.35dB(700-2700MHz)	11-21	1.22	1.67 x 1.47
RFASWK119ATF09	SP4T	0.4	3.0	0.40-0.75dB(1000-2700MHz)	14-24	1.78	1.6 x 1.6
RFASWK694BTF09	SP4T	0.5	2.7	0.30-0.67dB(615-2700MHz)	16-22	1.58	1.1 x 1.5
RFASWK014ATF09	SP4T	0.1	2.7	0.25-1.05 dB (700-2700MHz)	16-25	1.28	1.1 x 1.5

■ **Application Circuit (Network-GPIO)**

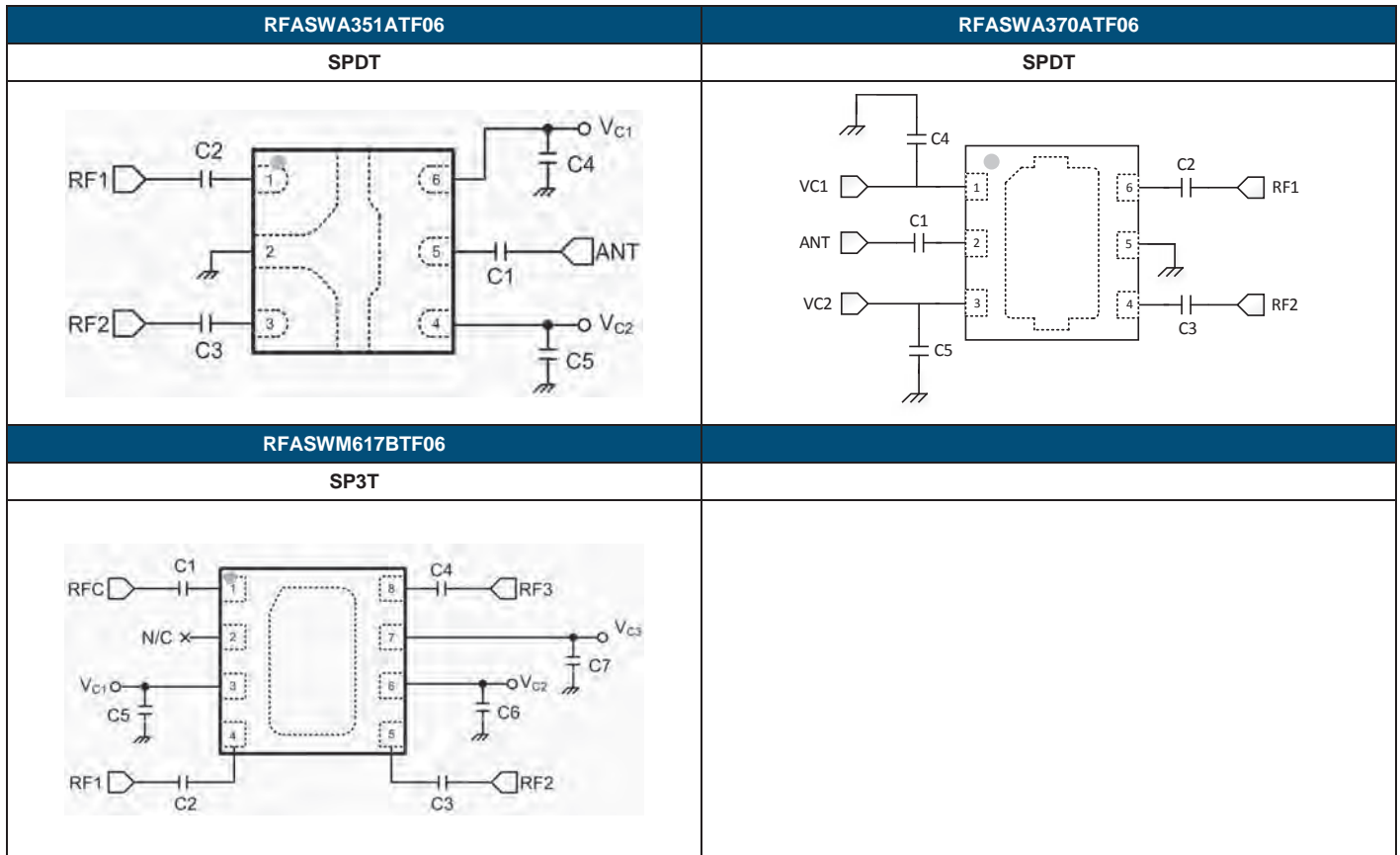

■ **ELECTRICAL SPECIFICATION**

Part Number	Description	Frequency (GHz) Min.	Frequency (GHz) Max.	Insertion loss (dB)	Isolation	VSWR	Package (mm)
RFASWA351ATF06	SPDT	0.5	6.0	0.35~0.70dB(500~6000MHz)	15~25	2	1.0 x 1.0
RFASWA370ATF06	SPDT	0.5	6.0	0.50~0.90dB(500~5850MHz)	23~28.5	1.67	1.5 x 1.5
RFASWM617BTF06	SP3T	0.5	6.0	0.35~0.65dB(500~6000MHz)	15~30	1.92	1.5 x 1.5

DIPOLE ANTENNA (N/SMA)

■ **ELECTRICAL SPECIFICATION**

Series	Size(mm)		Working Frequency Range	Gain	VSWR	Return Loss
	L	Ø				
8709	87	9.95	2.4~2.5 GHz	2dBi	<2	<-10dB
			2.4~2.5/5.x GHz	2.4~2.5 GHz : 2dBi 5.15~5.85 GHz : 3dBi	<2	<-10dB
1313	137.5	13	2.4~2.5 GHz	3dBi	<2	<-10dB
			2.4~2.5/5.x GHz	2.4~2.5 GHz : 3dBi 5.15~5.85 GHz : 3dBi	<2	<-10dB
1513	157.5	13	2.4~2.5 GHz	3dBi	<2	<-10dB
			2.4~2.5/5.x GHz	2.4~2.5 GHz : 3dBi 5.15~5.85 GHz : 3dBi	<2	<-10dB
1713	172.5	13	2.4~2.5 GHz	3dBi	<2	<-10dB
			2.4~2.5/5.x GHz	2.4~2.5 GHz : 4dBi 5.15~5.85 GHz : 5dBi	<2	<-10dB
3913	392	12.5	2.4~2.5 GHz	9dBi	<2	<-10dB
1310	135.7	10	2.4~2.5 GHz	5dBi	<2	<-10dB
			5.x GHz	5dBi	<2	<-10dB
			2.4~2.5/5.x GHz	3dBi~4dBi	<2	<-10dB
			Lora	3dBi	<2.5	<-7dB
			LTE	3dBi	<3	<-6dB
1413	148.5	13	2.4~2.5 GHz	3dBi	<2	<-10dB
			5.x GHz	3dBi	<2	<-10dB
			2.4~2.5/5.x GHz	3dBi	<2	<-10dB
			LTE	3dBi	<3	<-6dB
1615	169.9	13	LTE+Sub-6G+5G	0.93 dBi(@ 617 ~960 MHz) 2.71 dBi(@ 1710 ~ 2690 MHz) 3.66 dBi(@ 3300 ~4200 MHz) 4.37 dBi(@5150 ~7150 MHz)	<3.0 (@ 617~960 / 1710~2690 MHz) <3.0 (@ 3300~4200 / 5150~7150 MHz)	<6.0 dB (@ 617~960 / 1710~2690 MHz) <-6.0 dB (@ 3300~4200 / 5150~7150 MHz)
1913	196.6	13	2.4~2.5 GHz	5dBi	<2	<-10dB
			2.4~2.5/5.x GHz	2.4~2.5 GHz : 4dBi 5.15~5.85 GHz : 5dBi	<2	<-10dB
2213	217.1	13	2.4~2.5/5.x GHz	2.4~2.5 GHz : 5dBi 5.15~5.85 GHz : 4dBi	<2	<-10dB
			2.4~2.5 GHz	6dBi	<2	<-10dB
			2.4~2.5/5.x GHz	7dBi	<2	<-10dB
			5.x GHz	7dBi	<2	<-10dB
			LTE	5dBi	<3	<-6dB
2220	220	20	2.4 GHz	5dBi	<2	<-10dB
			5.x GHz	5dBi	<2	<-10dB
			2.4~2.5 GHz	7dBi	<2	<-10dB
2520	25	20	2.4 GHz	5~7dBi	<2	<-10dB
			5.x GHz	7dBi	<2	<-10dB
			2.4~2.5 GHz (High Gain)	7dBi	<2	<-10dB
4358	43.1	58.45	2.4~2.5 GHz 4.9~7.2 GHz	3.5dBi(@2.4~2.5 GHz) 2.5dBi(@4.9~7.2 GHz)	<2	<-10dB

8709	1313	1513	1713	3913
				
1310	1413	2213	2220	2520
				
1913	1615	4358		
				

DIPOLE ANTENNA (Cable)

■ **ELECTRICAL SPECIFICATION**

Series	Size(mm)		Working Frequency Range	Gain	VSWR	Return Loss
	L	Ø				
8709	87	9.35	2.4~2.5 GHz	2dBi	<2	<-10dB
			2.4~2.5/5.x GHz	2.4~2.5 GHz : 2dBi 5.15~5.85 GHz : 3dBi	<2	<-10dB
1313	133	9.35	2.4~2.5 GHz	3dBi	<2	<-10dB
			2.4~2.5/5.x GHz	2.4~2.5 GHz : 3dBi 5.15~5.85 GHz : 3dBi	<2	<-10dB
1513	152	9.35	2.4~2.5 GHz	3dBi	<2	<-10dB
			2.4~2.5/5.x GHz	2.4~2.5 GHz : 3dBi 5.15~5.85 GHz : 3dBi	<2	<-10dB
1514	158	14	2.4~2.5/5.x GHz	2.4~2.5 GHz : 5dBi 5.15~5.85 GHz : 7dBi	<2	<-10dB
1713	172	9.35	2.4~2.5 GHz	3dBi	<2	<-10dB
			2.4~2.5/5.x GHz	2.4~2.5 GHz : 4dBi 5.15~5.85 GHz : 5dBi	<2	<-10dB
1310	135.7	10	2.4~2.5 GHz	5dBi	<2	<-10dB
			5.x GHz	5dBi	<2	<-10dB
			2.4~2.5/5.x GHz	3dBi~4dBi	<2	<-10dB
			LTE	3dBi	<3	<-6dB
1913	192	9.35	2.4~2.5 GHz	5dBi	<2	<-10dB
			2.4~2.5/5.x GHz	2.4~2.5 GHz : 4dBi 5.15~5.85 GHz : 5dBi	<2	<-10dB

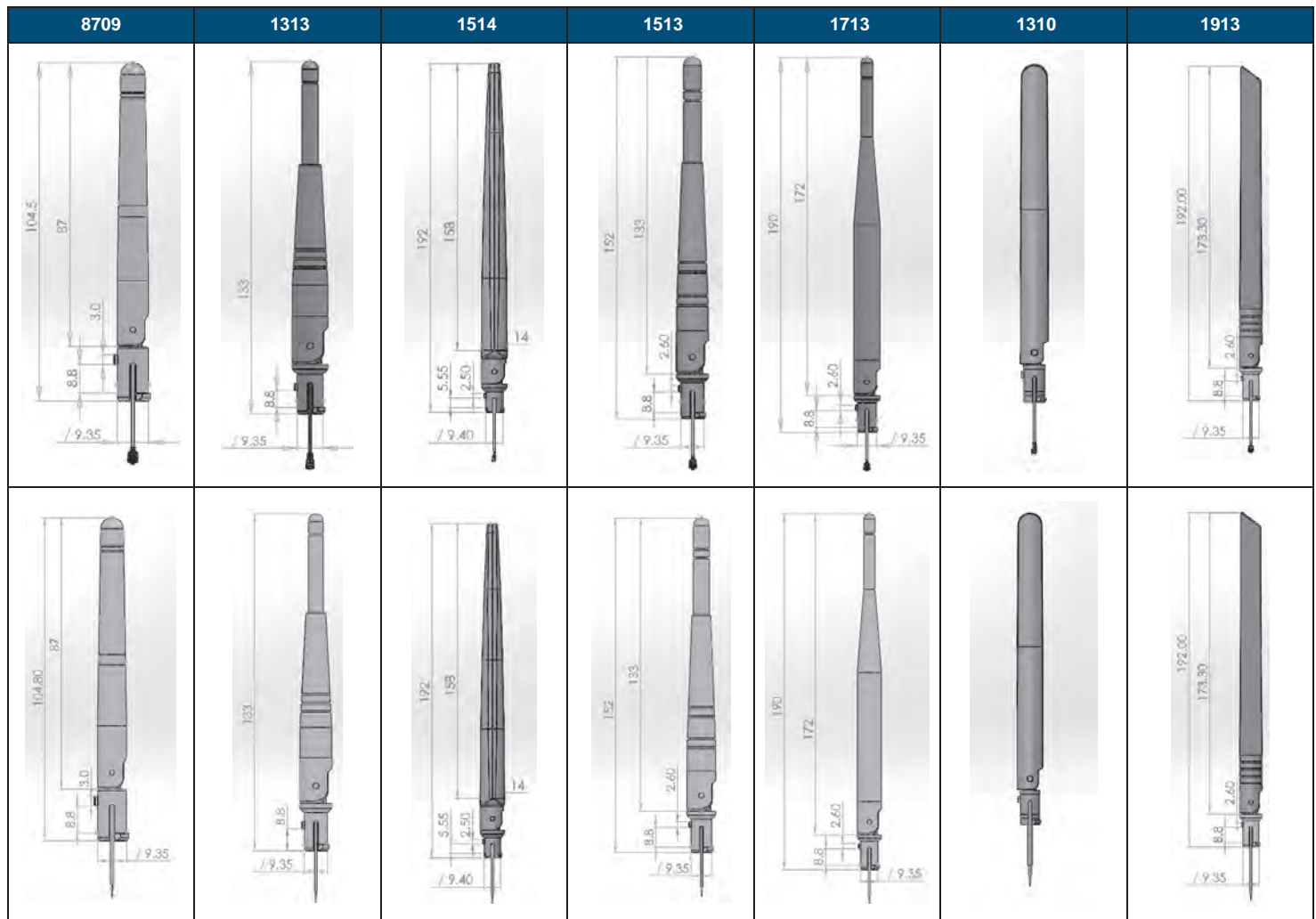

Cable Assembly

■ ELECTRICAL SPECIFICATION

Series	Connector 1	Connector 2	Wire Diameter	Color	L	Working Frequency Range	VSWR
1006	Straight Reverse SMA Jack	IPEX(or Strip & Tin)	Ø1.13/Ø1.37/RG178	Option	Option	DC ~ 6 GHz	2.0
1106	Straight Reverse SMA Jack	IPEX(or Strip & Tin)	Ø1.13/Ø1.37/RG178	Option	Option	DC ~ 6 GHz	2.0
1613	R/A Reverse SMA Jack	IPEX(or Strip & Tin)	Ø1.13/Ø1.37/RG178	Option	Option	DC ~ 6 GHz	2.0
0403	IPEX	IPEX(or Strip & Tin)	Ø0.81/Ø1.13/Ø1.37/RG178	Option	Option	DC ~ 6 GHz	2.0
0202	IPEX III	IPEX(or Strip & Tin)	Ø0.81	Option	Option	DC ~ 6 GHz	2.0
xxxx	Strip & Tin	Strip & Tin	Ø0.81/Ø1.13/Ø1.37/RG178	Option	Option	DC ~ 6 GHz	2.0
1015	N Jack	MMCX(or Strip & Tin)	RG316	Option	Option	DC ~ 6 GHz	2.0
1008	Straight Reverse SMA Plug	IPEX(or Strip & Tin)	RG405	Option	Option	DC ~ 6 GHz	2.0

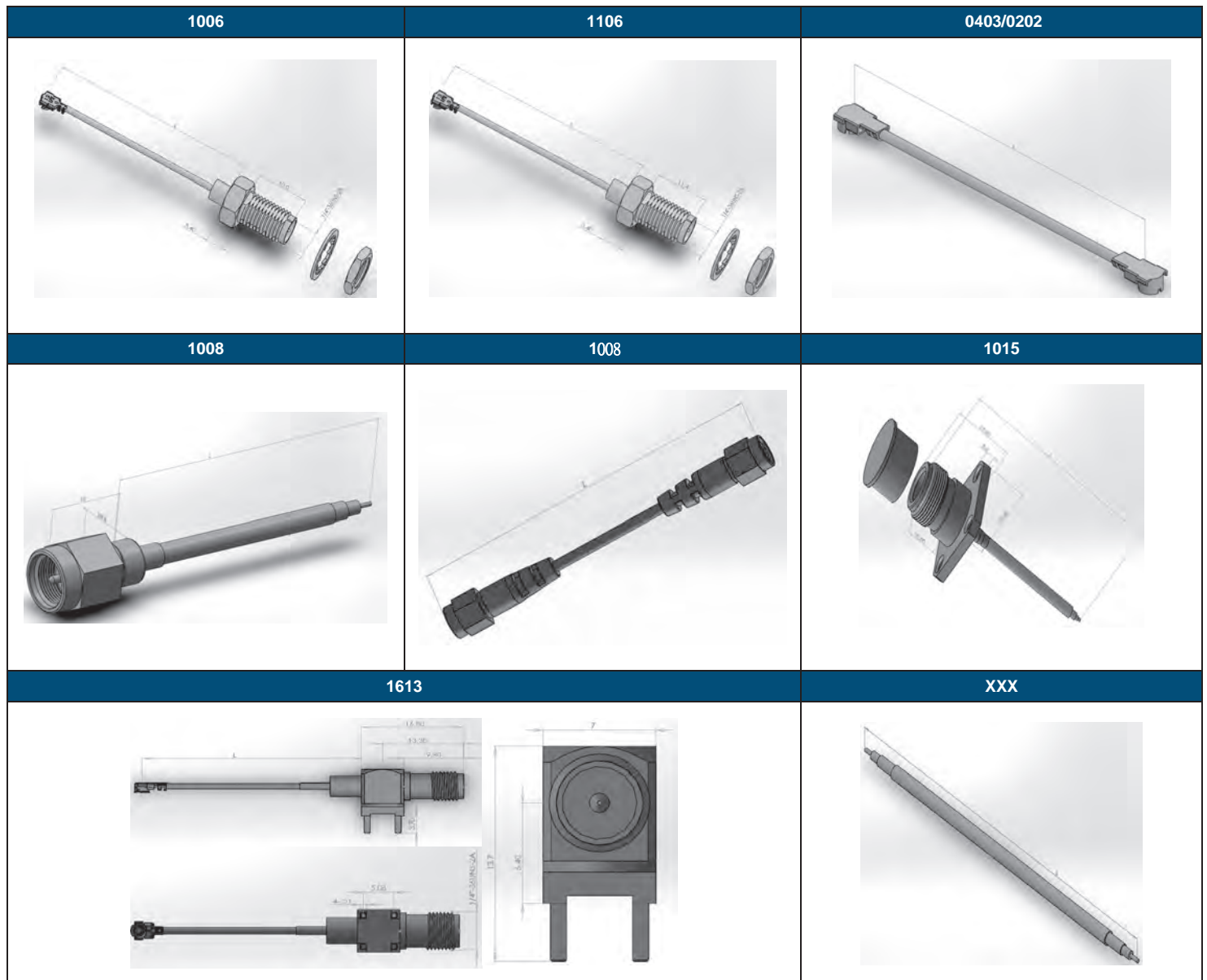

PCB Antenna

■ ELECTRICAL SPECIFICATION

Series	PCB Size(mm)		Cable Length (mm) L	Working Frequency Range	Gain	VSWR	Return Loss
	L	w					
1118	118	18	Option	LTE+Sub-6G+5G	3.32 dBi(@ 698 ~960 MHz) 6.04 dBi(@1710 ~ 2690 MHz) 5.36 dBi(@ 3300 ~3800 MHz) 4.39 dBi(@5150 ~5850 MHz)	<2.0(@ 698~960 MHz) <3.0(@1710~ 2690 / 3300 ~3800 / 5150~5850 MHz)	<-10.0 dB (@698~960 / 1710~2690 MHz) <-6.0 dB (@3300~3800 / 5150~5850 MHz)
2022	20	22	Option	LTE+Sub-6G+5G	5.54 dBi	<2	<-10dB
2313	23	13	Option	5 GHz	3dBi	<2	<-10dB
4305	43	5	Option	2.4~2.5 GHz	2dBi	<2	<-10dB
2010	20.1	10	Option	5 GHz	3dBi	<2	<-10dB
5010	50	10	Option	2.4~2.5 GHz	3dBi	<2	<-10dB
4308	43	8.3	Option	2.4~2.5/5.x GHz	2.4~2.5 GHz : 2dBi 5.x GHz : 3dBi	<2	<-10dB
4606	46.5	6	Option	2.4~2.5 GHz	2dBi	<2	<-10dB
3513	35	13	Option	2.4~2.5 GHz	4dBi	<2	<-10dB
3515	35	15	Option	2.4~2.5/5.x GHz	2.4~2.5 GHz : 2dBi 5.x GHz : 3dBi	<2	<-10dB



FPA Antenna

■ ELECTRICAL SPECIFICATION

Series	Size(mm)		Cable Length(mm) L	Working Frequency Range	Gain	VSWR	Return Loss
	L	w					
3025	30.3	25.3	Option	2.4~2.5 GHz	3dBi	<2	<-10dB
3225	25	32.6	Option	2.4~2.5 GHz	2dBi	<2	<-10dB
3226	32.35	26	Option	2.4~2.5 / 5.x GHz	3dBi	<2	<-10dB
4305	43	5.5	Option	2.4~2.5 GHz	3dBi	<2	<-10dB
3010	30	10	Option	2.4~2.5 GHz	2dBi	<2	<-10dB
2006	20	6	Option	5.x GHz	2dBi	<2	<-10dB

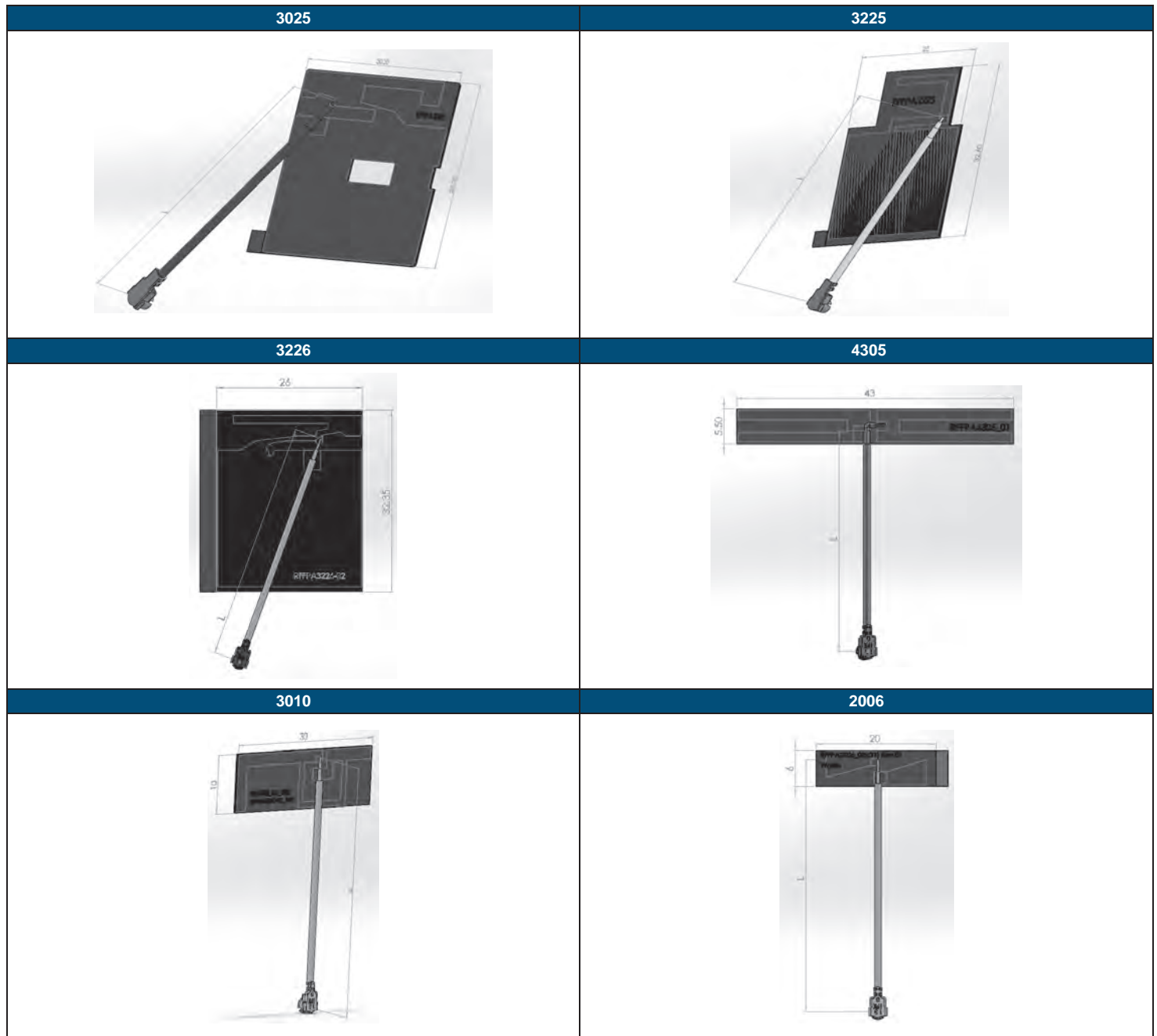

Metal Antenna

■ ELECTRICAL SPECIFICATION

Series	Size(mm)		Cable Length(mm) L	Working Frequency Range	Gain	VSWR	Return Loss
	L	w					
3109	31	9	Option	2.4~2.5/5.x GHz	2.4~2.5 GHz : 2 dBi 5.x GHz : 2 dBi	<2	<-10dB
2107	21.5	7.1	None	2.4~2.5 GHz	3 dBi	<2	<-10dB
2807	28.6	7.9	Option	2.4~2.5 GHz	3 dBi	<2	<-10dB
3407	34	7.5	Option	2.4~2.5 GHz	3 dBi	<2	<-10dB
3706	37.4	6.5	Option	2.4~2.5/5.x GHz	2.4~2.5 GHz : 5 dBi 5.x GHz : 5 dBi	<2	<-10dB
2712	27.75	12.8	None	2.4~2.5 GHz	3.38 dBi	<2	<-10dB
2811	27.05	11.3	None	2.4~2.5/5.x GHz	2.4~2.5 GHz : 2.66dBi 5.x GHz : 3.68dBi	<2	<-10dB
2911	29.6	11.3	None	2.4~2.5/5.x GHz	2.4~2.5 GHz : 2.14dBi 5.x GHz : 2.68dBi	<2	<-10dB



NFC Antenna (NFC/WPC/WNC)

■ ELECTRICAL SPECIFICATION

NFC

Series	Size(mm)		Ls	Rs	Q
	L	w			
5030	50	30	1.62±0.1μH	0.66±0.15Ω	15.42±2.5(1MHz)
5040	50	40	1.89±0.1μH	0.76±0.15Ω	15.62±2.5(1MHz)
6040	60	40	2.37±0.1μH	0.85±0.15Ω	17.5±2.5(1MHz)

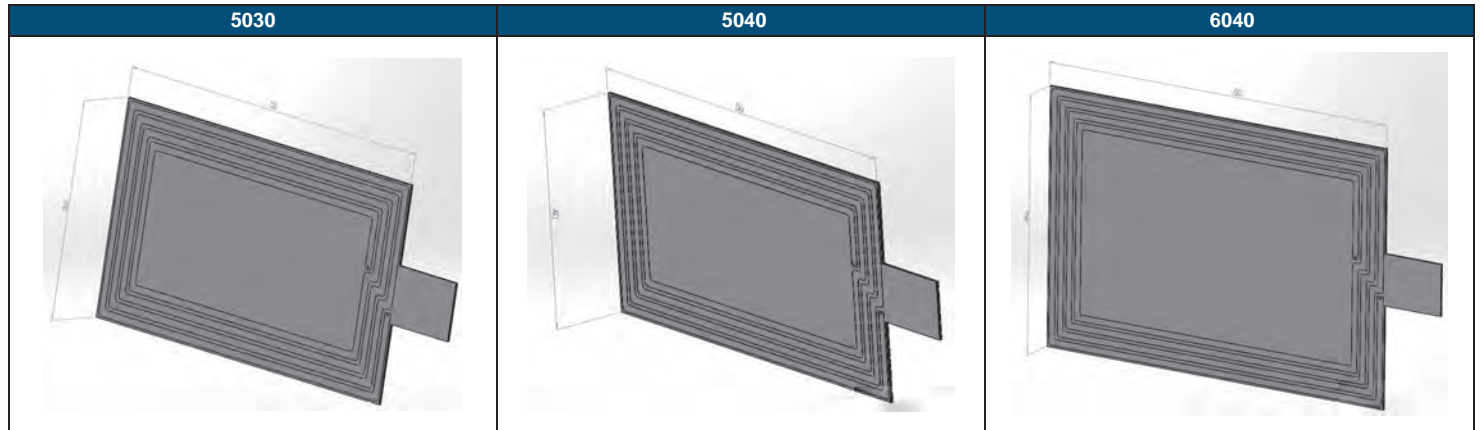

WPC & WNC

TYPE	Series	Size(mm)		Ls		Rs		Q	
		L	w	NFC	WPC	NFC	WPC	NFC	WPC
WPC	4832	48	32	1.35±0.1μH		0.3±0.15Ω		28.3±2.5(1MHz)	
WNC	6060	60	60	NFC	2.11±0.1μH	NFC	0.572±0.15Ω	NFC	37.2±2.5(1MHz)
				WPC	18.69±0.1μH	WPC	0.837±0.15Ω	WPC	14.03±2.5(1MHz)

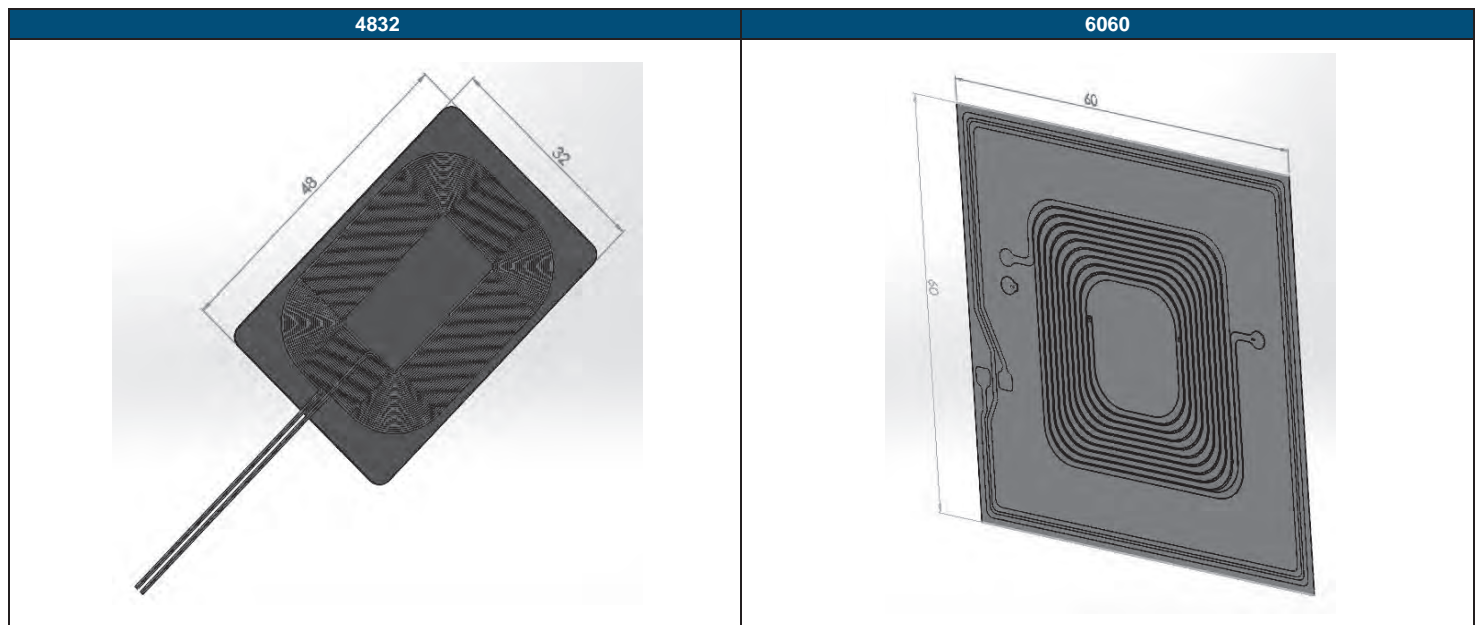

Connector

■ ELECTRICAL SPECIFICATION

Series	Size(mm)		Working Frequency Range	VSWR
	L	w		
1612	16.8	12.3	DC ~ 6 GHz	2.0
0703	7.5	3.3	DC ~ 6 GHz	2.0
1308	13.3	8	DC ~ 6 GHz	2.0
1609	16.5	9	DC ~ 6 GHz	2.0

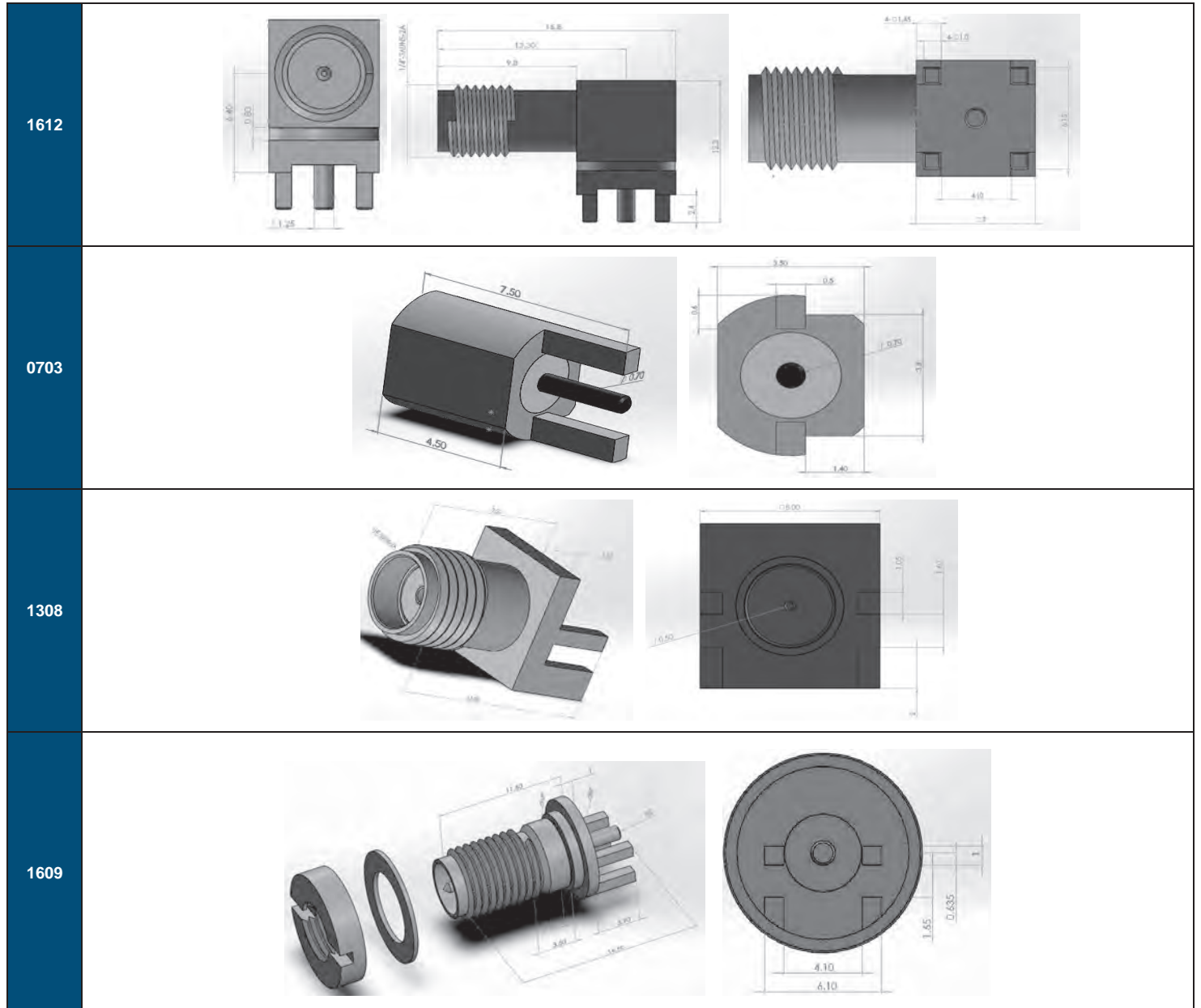

Measurement Equipment

■ Antenna Passive Measurement Efficiency / 3D Pattern @400MHz ~6GHz

■ Active Measurement TRP & TIS Measurement for GSM/WCDMA/TD-CDMA/TDD-LTE/FDD-LTE

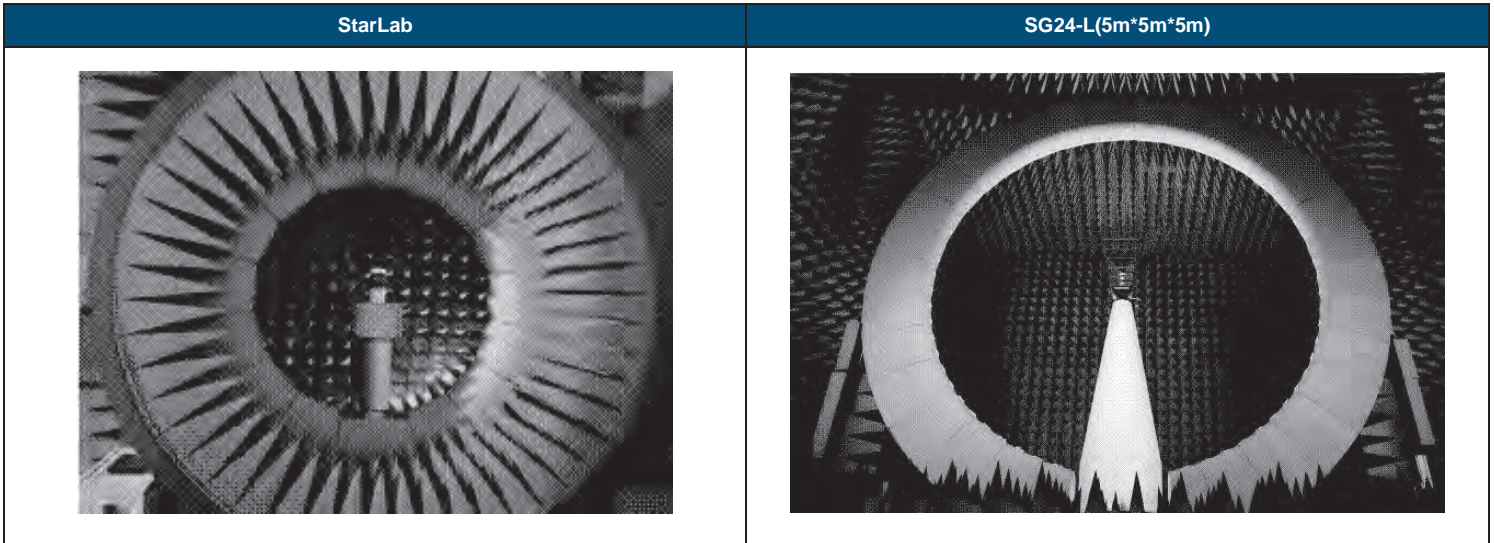

■ 2D Antenna Lab (Wireless Throughput Test)

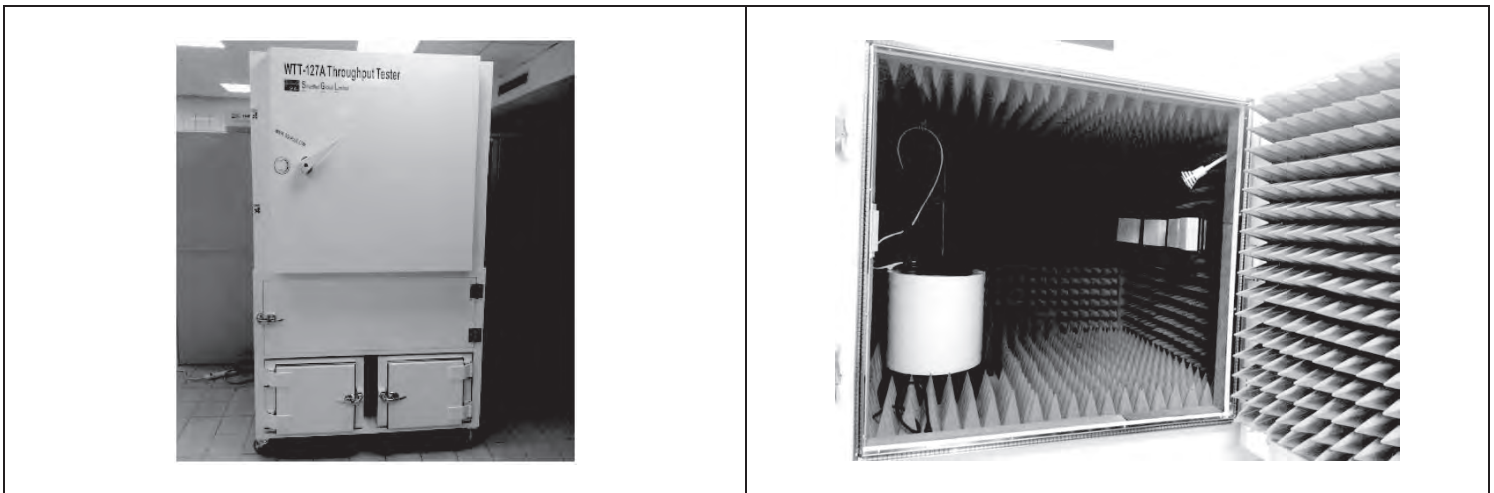

■ 2D Antenna Lab (Smart TV Wireless Throughput Test)

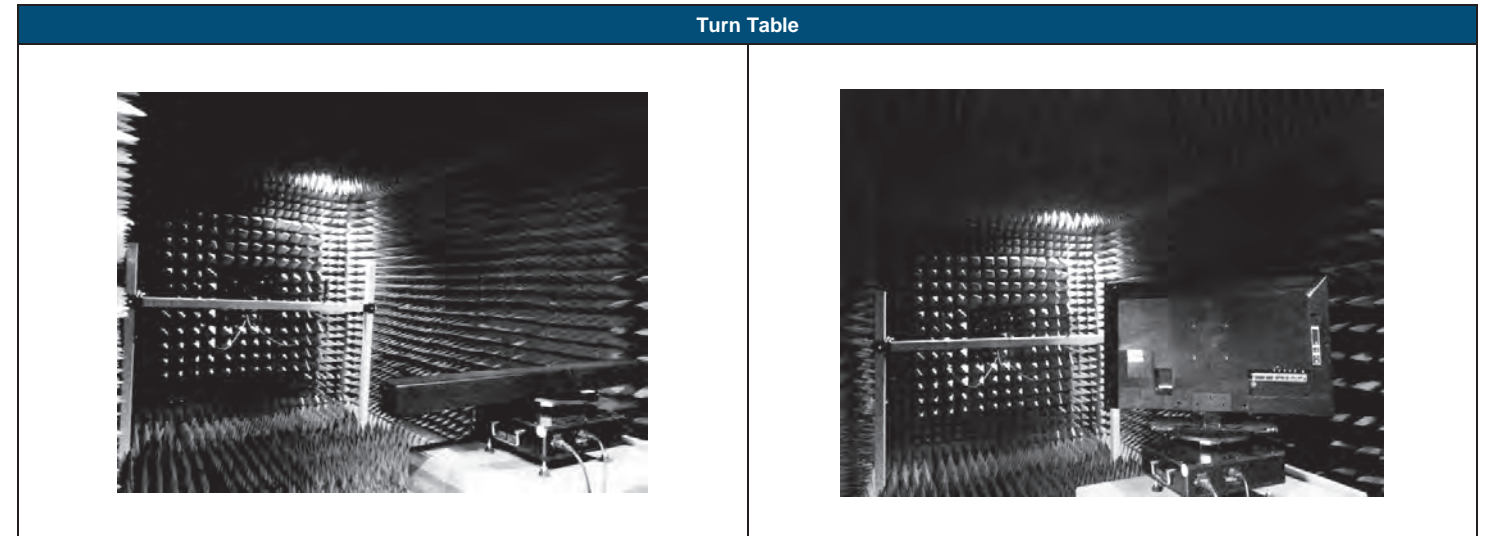

FIME EMVCo/ISO10373-6 / NFC Forum

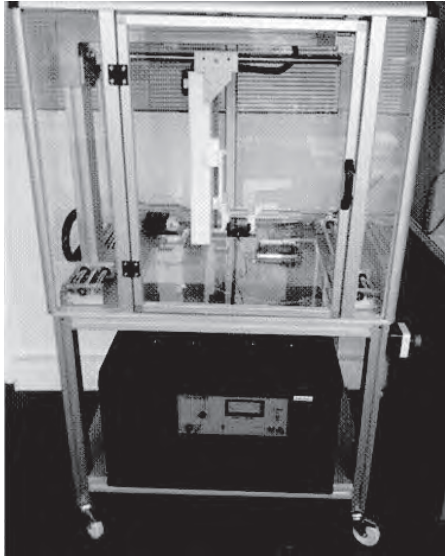

Comprion (NFC Forum)



Suzhou Smart TV Antenna Chamber



Shenzhen RayZone 1800



Taiwan - Yang-Mei Plant / Sales Office

Walsin Technology Corporation
566-1, Kao-Shi Road, Yang-Mei, Tao-Yuan, Taiwan
Tel: +886-3-475-8711 Fax: +886-3-475-7130 Email: info@passivecomponent.com

China - Dalang Plant / Sales Office

Dongguan Walsin Tech. Electronics CO., Ltd.
Xiniu Administrative Zone, Dalang Town, Dongguan City, Guangdong Province 523799
Tel: +86-769-831-15168 Fax: +86-769-831-15188 Email: msyu@passivecomponent.com

China - Suzhou Plant / Sales Office

Suzhou Walsin Technology Electronics Co., Ltd.
No. 369, Changyan Street, Suzhou Industrial Park, Jiangsu Province 215126
Tel: +86-512-628-36888 Fax: +86-512-628-37888 Email: msyu@passivecomponent.com

China - Guangzhou Plant / Sales Office

Pan Overseas (Guangzhou) Electronic Co., Ltd.
No. 277, Hong Ming Road, Eastern Section, Guangzhou Economic and Technology, Development Zone, China
Tel: +86-20-8223-7476 Fax: +86-20-8223-7475 Email: msyu@passivecomponent.com

Germany - Munich Sales Office

Walsin Technology Corporation Europe
Bretonischer Ring 6, Pavillon 3, 85630 Grasbrunn, Germany
Tel: +49-(0)89-9308-6475 Fax: +49-(0)89-9308-6464 Email: aw@passivecomponent.com

Singapore - Sales Office

WTC Singapore Sales Office, Singapore
24 Sin Ming Lane Midview City, #04-100, Singapore 573970
Contact: Morris Liew
Tel: +65-6262 3997 Email: [morisliew@sg.passivecomponent.com](mailto:morrisliew@sg.passivecomponent.com)

Malaysia - Sales Office

Walsin Technology Corporation, Malaysia
1st Floor, No.19, Jalan Puteri 5/8, Bandar Puteri Puchong, Puchong, 47100, Selangor, Malaysia
Contact: Arthur Ling
Tel : +6016-2217-948 Fax : +603-8051-7060 Email : arthurling@passivecomponent.com

United States - West Coast Sales Office

Walsin Technology Corporation, USA
Contact: FC Tseng
Tel: +1-214-708-5182 E-mail: fctseng@passivecomponent.com

JAPAN - Sales Office

PSA BLDG. 3F, 6-1-6 Chuou, Yamato-Shi, Kanagawa, 242-0021 Japan
Tel:+81-46-204-8829 Fax:+81-46-204-8955 Email: tsakano@kamaya.co.jp

PSA PASSIVE SYSTEM ALLIANCE
WALSIN TECHNOLOGY CORPORATION

Looking for pricing, stock, or lifecycle information?

Click below to explore more details on WIN SOURCE:

- ⊖ [View RFBPB2012090A7T on WIN SOURCE](#)
- ⊖ [Walsin Technology Corporation Information](#)

Optimize Your Supply Chain with WIN SOURCE Solutions

- ✓ Global Sourcing Solution
- ✓ Obsolete Management
- ✓ Cost Control Management
- ✓ Shortage Management
- ✓ Alternative Solution
- ✓ Excess Inventory Management