



SMT inductors

SIMID series, SIMID 2220-T

Series/Type: **B82442T**

Date: July 2016

© EPCOS AG 2016. Reproduction, publication and dissemination of this publication, enclosures hereto and the information contained therein without EPCOS' prior express consent is prohibited.

EPCOS AG is a TDK Group Company.

SMD

Size 2220 (EIA) or 5650 (IEC)
Rated inductance 1 ... 10000 μ H
Rated current 46 ... 3510 mA



Construction

- Ferrite drum core
- Laser-welded winding
- Flame-retardant molding

Features

- Temperature range up to +150 °C
- Very high current handling capability
- High L values
- Qualified to AEC-Q200
- Suitable for lead-free reflow soldering as referenced in JEDEC J-STD 020D
- RoHS-compatible
- Halogen-free

Applications

- Filtering of supply voltages, coupling, decoupling
- DC/DC converters/switch-mode power supplies
- Automotive electronics
- Telecommunications
- Consumer electronics
- Industrial electronics

Terminals

- Base material CuSn6
- Layer composition Ni, Sn (lead-free)
- Electro-plated

Marking

- Marking on component:
 Manufacturer, letter "T", L value (in μ H),
 tolerance of L value (coded), date of manufacture (YWWDD)
- Minimum data on reel:
 Manufacturer, ordering code, L value, quantity, date of packing

Delivery mode and packing unit

- 12-mm blister tape, wound on 330-mm \varnothing reel
- Packing unit: 1500 pcs./reel

SIMID 2220-T

SMD

Dimensional drawing and layout recommendation

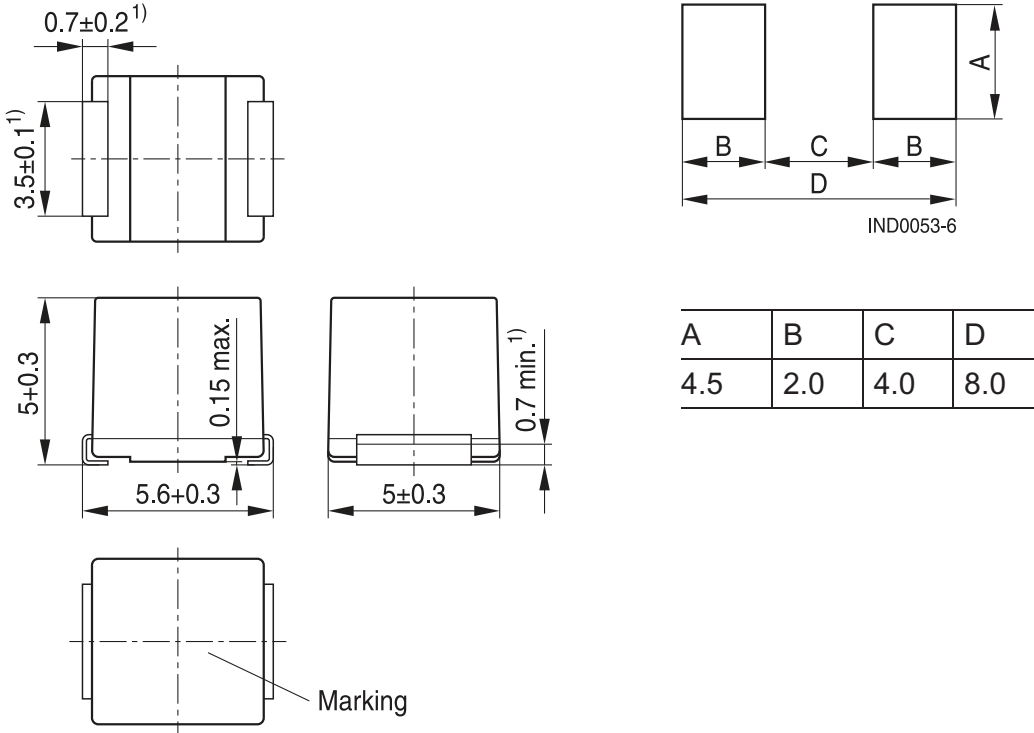

1) Soldering area

IND1306-H-E

Dimensions in mm

Taping and packing

Blister tape

Reel

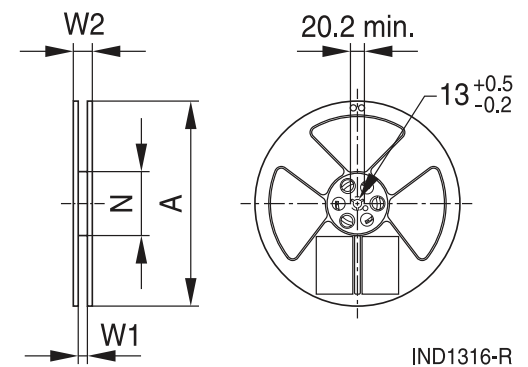
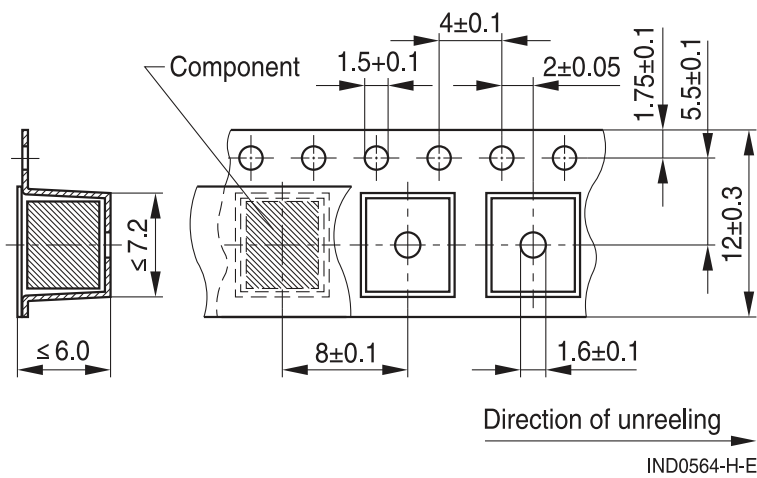

Dimensions in mm

W1	W2	A	N
12.4	18.4	330	100

SMD
Technical data and measuring conditions

Rated inductance L_R	Measured with impedance analyzer Agilent 4294A at frequency f_L , 0.5 V, +23 ±5 °C
Q factor Q_{min}	Measured with impedance analyzer Agilent 4294A at frequency f_Q , 0.5 V, +23 ±5 °C
Rated temperature T_R	+85 °C
Rated current I_R	Maximum permissible DC with temperature increase of ≤ 65 K at rated temperature
Saturation current I_{sat}	Maximum permissible DC with inductance decrease $\Delta L/L_0 \leq 10\%$, at +23 ±5 °C
Self-resonance frequency $f_{res,min}$	Measured with impedance analyzer Agilent 4294A / E4991A at +23 ±5 °C
DC resistance R_{max}	Measured at +23 ±5 °C
Solderability (lead-free)	Sn95.5Ag3.8Cu0.7: +(245 ±5) °C, (5 ±0.3) s Wetting of soldering area ≥ 90% (based on IEC 60068-2-58)
Resistance to soldering heat	+260 °C, 40 s (as referenced in JEDEC J-STD 020D)
Climatic category	55/150/56 (to IEC 60068-1)
Storage conditions	Mounted: -55 °C ... +150 °C Packaged: -25 °C ... +40 °C, ≤ 75% RH
Weight	Approx. 0.4 g

SMD
Characteristics and ordering codes

L_R μH	Tolerance	Q_{\min}	$f_L; f_Q$ MHz	I_R mA	I_{sat} mA	R_{max} Ω	$f_{\text{res,min}}$ MHz	Ordering code
1.0	$\pm 10\% \triangleq K$	15	7.96	3510	7330	0.025	111	B82442T1102K050
1.2		15	7.96	3090	6030	0.028	75	B82442T1122K050
1.5		15	7.96	3020	5480	0.033	60	B82442T1152K050
1.8		15	7.96	2770	4890	0.035	55	B82442T1182K050
2.2		15	7.96	2710	4820	0.038	46	B82442T1222K050
2.7		15	7.96	2530	3980	0.042	36	B82442T1272K050
3.3		15	7.96	2460	4010	0.046	36	B82442T1332K050
3.9		15	7.96	2170	3310	0.057	33	B82442T1472K050
4.7		15	7.96	1950	3450	0.073	30	B82442T1472K050
5.6		15	7.96	1850	2780	0.078	28	B82442T1562K050
6.8		15	7.96	1680	2770	0.106	23	B82442T1682K050
8.2		15	7.96	1510	2330	0.118	21	B82442T1822K050
10		15	2.52	1420	2280	0.132	19	B82442T1103K050
12		15	2.52	1380	2160	0.141	19	B82442T1123K050
15		15	2.52	1260	1870	0.190	16	B82442T1153K050
18	15	2.52	1090	1780	0.210	14	B82442T1183K050	
22	15	2.52	1040	1590	0.238	13	B82442T1223K050	
27	15	2.52	880	1400	0.307	11	B82442T1273K050	
33	15	2.52	840	1380	0.360	11	B82442T1333K050	
39	15	2.52	720	1190	0.456	9.0	B82442T1393K050	
47	15	2.52	700	1120	0.519	8.0	B82442T1473K050	
56	15	2.52	600	1010	0.679	7.5	B82442T1563K050	
68	15	2.52	570	900	0.781	7.0	B82442T1683K050	
82	15	2.52	540	830	0.832	6.6	B82442T1823K050	
100	20	0.796	510	760	0.99	6.1	B82442T1104K050	
120	20	0.796	440	670	1.29	5.3	B82442T1124K050	
150	20	0.796	410	610	1.50	4.6	B82442T1154K050	
180	20	0.796	350	550	1.96	4.2	B82442T1184K050	
220	20	0.796	330	500	2.21	3.9	B82442T1224K050	
270	20	0.796	290	450	2.95	3.5	B82442T1274K050	
330	20	0.796	280	430	3.29	3.4	B82442T1334K050	
390	20	0.796	260	390	3.70	3.0	B82442T1394K050	
470	20	0.796	240	350	4.73	2.6	B82442T1474K050	
560	20	0.796	220	320	5.21	2.4	B82442T1564K050	
680	20	0.796	210	300	5.87	2.3	B82442T1684K050	
820	20	0.796	170	270	7.86	2.2	B82442T1824K050	
1000	30	0.252	150	246	9.5	1.8	B82442T1105K050	

SMD

L_R μH	Tolerance	Q_{\min}	$f_L; f_Q$ MHz	I_R mA	I_{sat} mA	R_{max} Ω	$f_{\text{res, min}}$ MHz	Ordering code
1200	$\pm 5\% \triangleq \text{J}$	30	0.252	140	223	12.6	1.7	B82442T1125+050
1500	$\pm 10\% \triangleq \text{K}$	30	0.252	130	200	14.9	1.5	B82442T1155+050
1800		30	0.252	110	183	19.7	1.4	B82442T1185+050
2200		30	0.252	100	168	22.5	1.2	B82442T1225+050
2700		30	0.252	90	151	29.5	1.1	B82442T1275+050
3300		30	0.252	85	138	32.8	1.0	B82442T1335+050
3900		30	0.252	74	127	43.5	0.9	B82442T1395+050
4700		30	0.252	73	119	48.6	0.8	B82442T1475+050
5600		30	0.252	66	109	54.7	0.8	B82442T1565+050
6800		30	0.252	65	102	60.3	0.6	B82442T1685+050
8200		30	0.252	54	92	80.6	0.6	B82442T1825+050
10000	25	0.0796	46	81	112	0.5	B82442T1106+050	

Closer tolerances and intermediate values on request.

Higher currents possible at temperatures $< T_R$ on request.

Sample kit available. Ordering code: B82442X002

For more information refer to chapter "Sample kits".

SMD

Impedance $|Z|$ versus frequency f
measured with impedance analyzer Agilent 4294A/E4991A, typical values at +20 °C

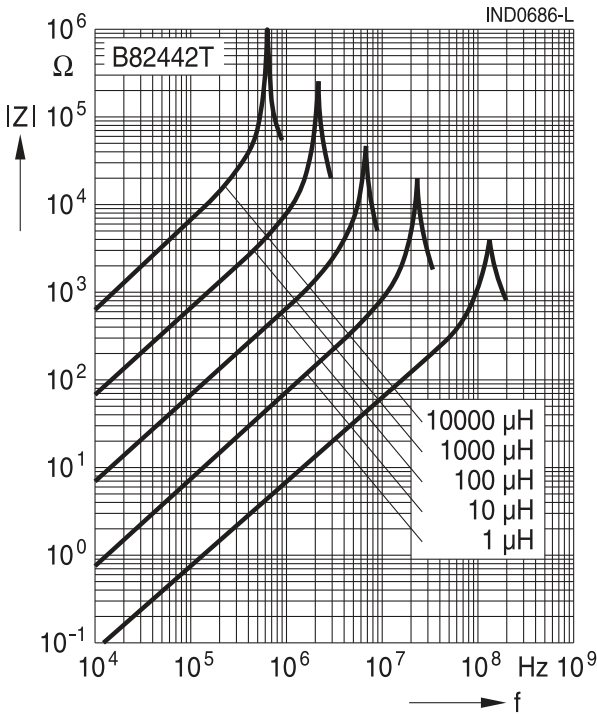

Inductance L versus DC load current I_{DC}
measured with LCR meter Agilent 4285A, typical values at +20 °C

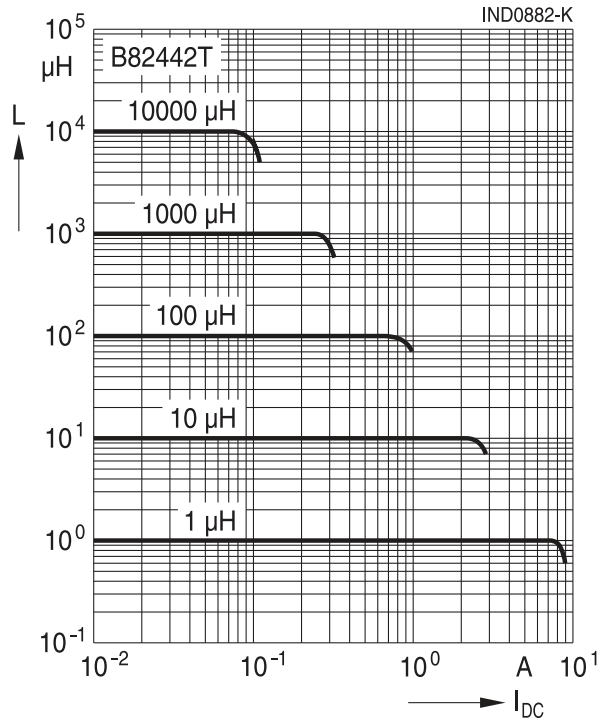

Q factor versus frequency f
measured with impedance analyzer Agilent 4294A/E4991A, typical values at +20 °C

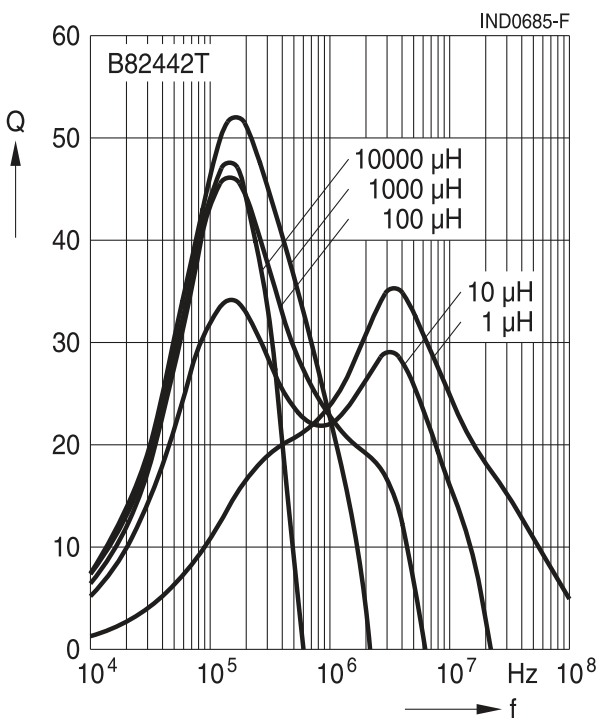

Current derating I_{op}/I_R versus ambient temperature T_A
(rated temperature $T_R = +85$ °C)

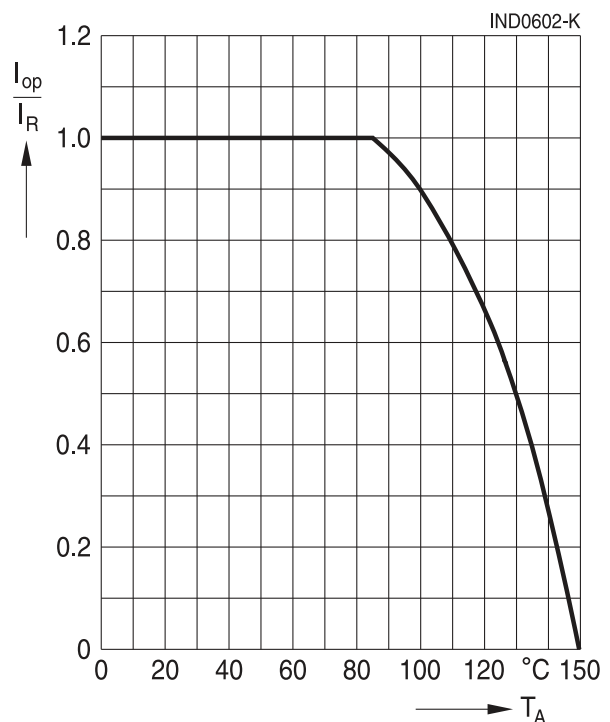

Cautions and warnings

- Please note the recommendations in our Inductors data book (latest edition) and in the data sheets.
 - Particular attention should be paid to the derating curves given there.
 - The soldering conditions should also be observed. Temperatures quoted in relation to wave soldering refer to the pin, not the housing.
- If the components are to be washed varnished it is necessary to check whether the washing varnish agent that is used has a negative effect on the wire insulation, any plastics that are used, or on glued joints. In particular, it is possible for washing varnish agent residues to have a negative effect in the long-term on wire insulation.
Washing processes may damage the product due to the possible static or cyclic mechanical loads (e.g. ultrasonic cleaning). They may cause cracks to develop on the product and its parts, which might lead to reduced reliability or lifetime.
- The following points must be observed if the components are potted in customer applications:
 - Many potting materials shrink as they harden. They therefore exert a pressure on the plastic housing or core. This pressure can have a deleterious effect on electrical properties, and in extreme cases can damage the core or plastic housing mechanically.
 - It is necessary to check whether the potting material used attacks or destroys the wire insulation, plastics or glue.
 - The effect of the potting material can change the high-frequency behaviour of the components.
- Ferrites are sensitive to direct impact. This can cause the core material to flake, or lead to breakage of the core.
- Even for customer-specific products, conclusive validation of the component in the circuit can only be carried out by the customer.

Display of ordering codes for EPCOS products

The ordering code for one and the same product can be represented differently in data sheets, data books, other publications and the website of EPCOS, or in order-related documents such as shipping notes, order confirmations and product labels. **The varying representations of the ordering codes are due to different processes employed and do not affect the specifications of the respective products.** Detailed information can be found on the Internet under www.epcos.com/orderingcodes.

Important notes

The following applies to all products named in this publication:



1. Some parts of this publication contain **statements about the suitability of our products for certain areas of application**. These statements are based on our knowledge of typical requirements that are often placed on our products in the areas of application concerned. We nevertheless expressly point out **that such statements cannot be regarded as binding statements about the suitability of our products for a particular customer application**. As a rule we are either unfamiliar with individual customer applications or less familiar with them than the customers themselves. For these reasons, it is always ultimately incumbent on the customer to check and decide whether a product with the properties described in the product specification is suitable for use in a particular customer application.
2. We also point out that **in individual cases, a malfunction of electronic components or failure before the end of their usual service life cannot be completely ruled out in the current state of the art, even if they are operated as specified**. In customer applications requiring a very high level of operational safety and especially in customer applications in which the malfunction or failure of an electronic component could endanger human life or health (e.g. in accident prevention or life-saving systems), it must therefore be ensured by means of suitable design of the customer application or other action taken by the customer (e.g. installation of protective circuitry or redundancy) that no injury or damage is sustained by third parties in the event of malfunction or failure of an electronic component.
3. **The warnings, cautions and product-specific notes must be observed.**
4. In order to satisfy certain technical requirements, **some of the products described in this publication may contain substances subject to restrictions in certain jurisdictions (e.g. because they are classed as hazardous)**. Useful information on this will be found in our Material Data Sheets on the Internet (www.tdk-electronics.tdk.com/material). Should you have any more detailed questions, please contact our sales offices.
5. We constantly strive to improve our products. Consequently, **the products described in this publication may change from time to time**. The same is true of the corresponding product specifications. Please check therefore to what extent product descriptions and specifications contained in this publication are still applicable before or when you place an order.

We also **reserve the right to discontinue production and delivery of products**. Consequently, we cannot guarantee that all products named in this publication will always be available. The aforementioned does not apply in the case of individual agreements deviating from the foregoing for customer-specific products.
6. Unless otherwise agreed in individual contracts, **all orders are subject to our General Terms and Conditions of Supply**.
7. **Our manufacturing sites serving the automotive business apply the IATF 16949 standard**. The IATF certifications confirm our compliance with requirements regarding the quality management system in the automotive industry. Referring to customer requirements and customer specific requirements ("CSR") TDK always has and will continue to have the policy of respecting individual agreements. Even if IATF 16949 may appear to support the acceptance of unilateral requirements, we hereby like to emphasize that **only requirements mutually agreed upon can and will be implemented in our Quality Management System**. For clarification purposes we like to point out that obligations from IATF 16949 shall only become legally binding if individually agreed upon.
8. The trade names EPCOS, CeraCharge, CeraDiode, CeraLink, CeraPad, CeraPlas, CSMP, CTVS, DeltaCap, DigiSiMic, ExoCore, FilterCap, FormFit, LeaXield, MiniBlue, MiniCell, MKD, MKK, MotorCap, PCC, PhaseCap, PhaseCube, PhaseMod, PhiCap, PowerHap, PQSine, PQvar, SIFERRIT, SIFI, SIKOREL, SilverCap, SIMDAD, SiMic, SIMID, SineFormer, SIOV, ThermoFuse, WindCap are **trademarks registered or pending** in Europe and in other countries. Further information will be found on the Internet at www.tdk-electronics.tdk.com/trademarks.

Release 2018-10

Looking for pricing, stock, or lifecycle information?

Click below to explore more details on WIN SOURCE:

-  [View B82442T1273K50 on WIN SOURCE](#)
-  [EPCOS \(TDK\) Information](#)

Optimize Your Supply Chain with WIN SOURCE Solutions

-  Global Sourcing Solution
-  Obsolete Management
-  Cost Control Management
-  Shortage Management
-  Alternative Solution
-  Excess Inventory Management