



THE DATASHEET OF MUR2040CT



MUR2040CT/MUR2040FCT

Ultrafast Recovery Rectifiers
 Reverse Voltage 400V Forward Current 20 A

Features

- FRED (Planar) wafer construction
- Ultrafast recovery time
- Low forward voltage drop, low power loss
- High efficiency
- Plastic package has underwriters Laboratory Flammability Classification 94V-0
- UL certified



MUR2040CT
 Package: TO-220-AB



MUR2040FCT
 Package: ITO-220-AB

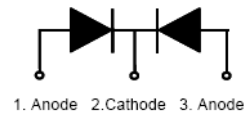

Schematic Diagram

Mechanical Data

- Case: Epoxy, molded
- Weight: 1.9 grams (approximately)
- Finish: all external surfaces corrosion resistant and terminal leads readily solderable
- Lead temperature for soldering purposes: 260°C Max. for 10 sec
- 50 units per plastic tube

Maximum Ratings & Electrical Characteristics

($T_A=25^\circ\text{C}$ unless otherwise noted)

Parameter	Test Conditions		Symbol	Value	Unit
Maximum Repetitive Peak Reverse Voltage			V_{RRM}	400	V
Working Peak Reverse Voltage			V_{RWM}	400	V
Maximum DC Blocking Voltage			V_{DC}	400	V
Maximum Average Forward Rectified Current @ $T_c=105^\circ\text{C}$	Total Device		$I_{F(AV)}$	20	A
	Per Diode			10	
Peak Forward Surge Current 8.3ms Single Half Sine-wave Superimposed on Rated Load per Diode			I_{FSM}	125	A
Voltage Rate of Change (rated V_R)			DV/dt	10000	V/ μs
Operating Junction Temperature Range			T_J	- 55 to+150	$^\circ\text{C}$
Storage Temperature Range			T_{STG}	- 55 to+150	$^\circ\text{C}$
Maximum Reverse Recover Time ($I_F=0.5\text{A}$, $I_R=1.0\text{A}$, $I_{rec}=0.25\text{A}$)			T_{rr}	35	ns
Maximum Instantaneous Forward Voltage per Leg	$I_F=10\text{A}$	$T_c=25^\circ\text{C}$	V_F	1.50	V
	$I_F=10\text{A}$	$T_c=125^\circ\text{C}$		1.40	
Maximum Reverse Current per Leg at Working Peak Reverse Voltage		$T_J=25^\circ\text{C}$	I_R	10	μA
		$T_J=100^\circ\text{C}$		500	μA
Thermal Characteristics $T_A=25^\circ\text{C}$ unless otherwise noted					
Symbol	Parameter		Typ.(MUR2040CT)	Typ.(MUR2040FCT)	Unit
$R_{\theta JC}$	Thermal Resistance, Junction to Case per Leg		2.0	4.0	$^\circ\text{C}/\text{W}$
$R_{\theta JA}$	Thermal Resistance, Junction to Ambient per Leg		62.5	62.5	$^\circ\text{C}/\text{W}$

Note: Pulse test:300us pulse width, duty cycle=2%

Ratings and Characteristics Curves ($T_A = 25^\circ\text{C}$ unless otherwise noted)

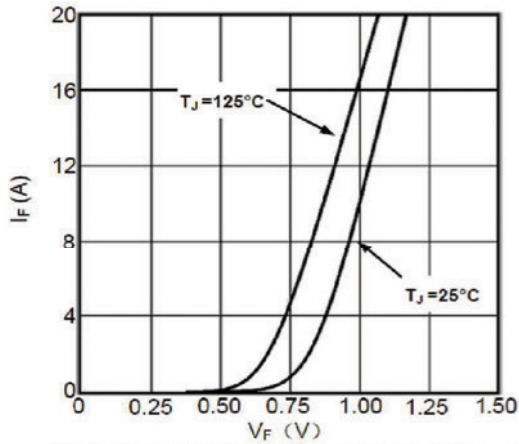

Fig1. Forward Voltage Drop vs Forward Current

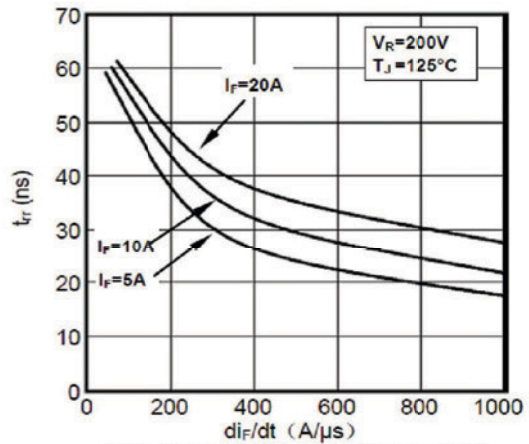

Fig2. Reverse Recovery Time vs di_F/dt

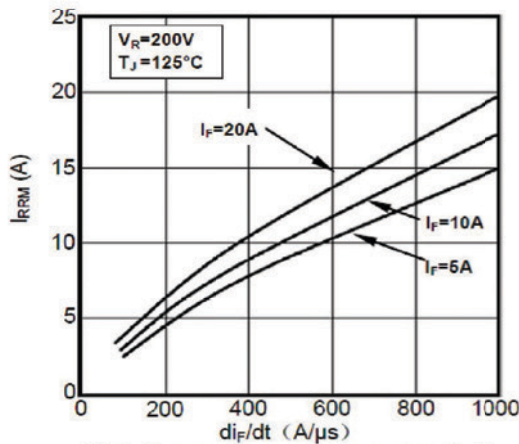

Fig3. Reverse Recovery Current vs di_F/dt

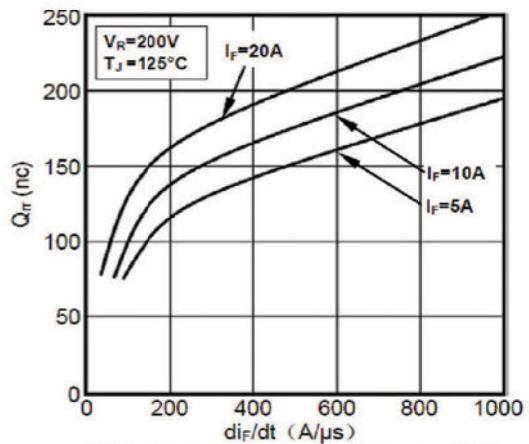

Fig4. Reverse Recovery Charge vs di_F/dt

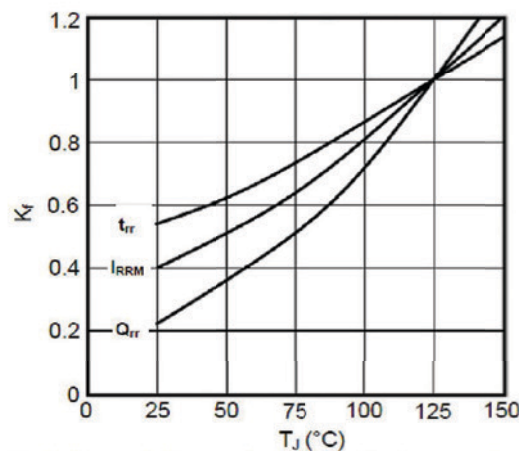

Fig5. Dynamic Parameters vs Junction Temperature

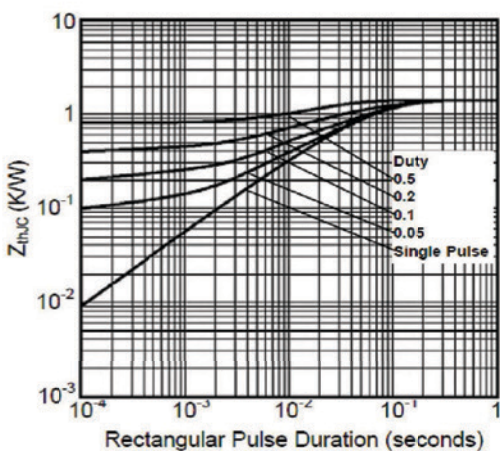

Fig6. Transient Thermal Impedance

MUR2040CT/MUR2040FCT

Ultrafast Recovery Rectifiers
 Reverse Voltage 400V Forward Current 20 A

Package Outline Dimensions

in millimeters

TO-220-AB

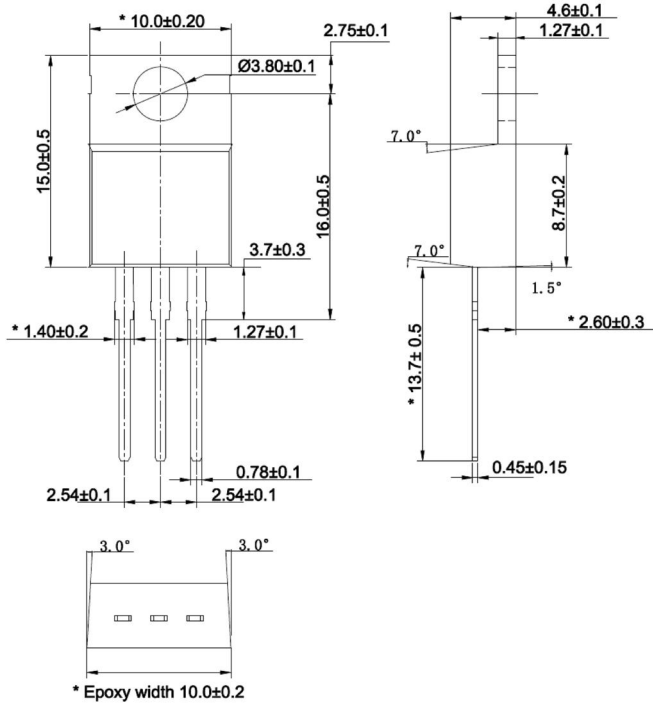

ITO-220-AB

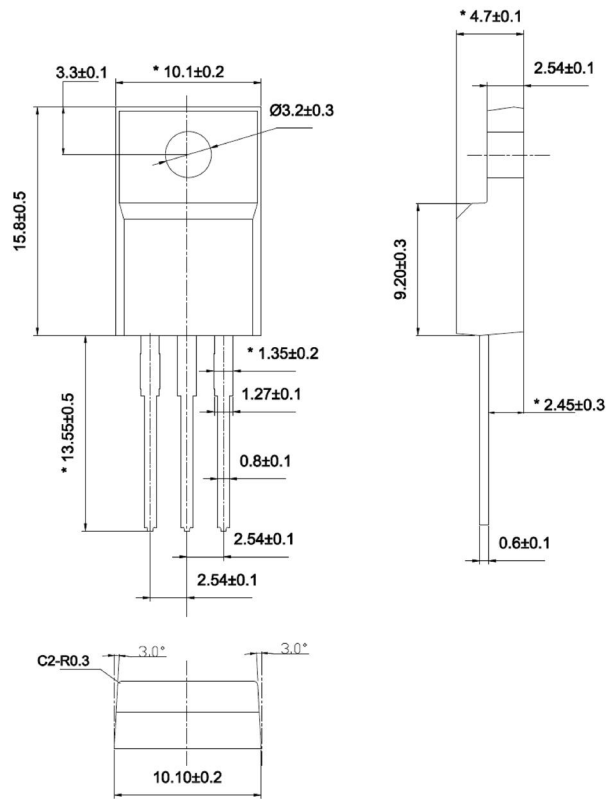

Looking for pricing, stock, or lifecycle information?

Click below to explore more details on WIN SOURCE:

- ⊖ [View MUR2040CT on WIN SOURCE](#)
- ⊖ [GOOD-ARK Electronics Information](#)

Optimize Your Supply Chain with WIN SOURCE Solutions

- ✓ Global Sourcing Solution
- ✓ Obsolete Management
- ✓ Cost Control Management
- ✓ Shortage Management
- ✓ Alternative Solution
- ✓ Excess Inventory Management