



THE DATASHEET OF IR2E51Y6



IR2E51Y

Auto-Brightness Control LED Driver

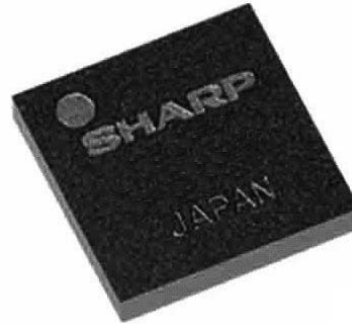

■ Description

IR2E51Y incorporates white LED driver with auto brightness control.

This IC is equipped with charge pump DC/DC converter. Input voltage is boosted into CPO by a charge pump circuit. This IC maintains high efficiency since the charge pump circuit automatically selects 1x or 1.5x charge pump mode depending on input voltage and load.

It contains 4 white LED drivers to drive the main-LCD backlight, 2 white LED drivers for sub-LCD backlight and RGB-LED drivers.

All LED are connected in parallel.

With peripheral ambient light sensor, this IC automatically adjusts white LED brightness to ambient brightness.

This IC supports I²C-Bus interface.

This product is optimum for use as the backlight white LED driver IC for cellular phone and PDA applications, etc.

■ Features

1. Supply Voltage Range: $V_{IN}=3.0V$ to $4.5V$, $V_{CC}=2.3V$ to $3.2V$
2. Supports I²C-Bus interface
3. SCL pin and SDA pin are installed with noise filters.
4. Sink-type variable constant current driver for LED (maximum current 27.4mA/ch)
5. Monitoring all LED pins (Response to VF variation of LED)
6. Auto brightness control circuit for main-LCD embedded. (16 steps and 128 gradation sequence)
7. PWM LED Brightness Control (0% to 100%) (RGB) (The PWM signal frequency of 2kHz to 5kHz is recommended.)
8. 1x/1.5x Modes Charge Pump: Automatically Selected
9. Voltage reference embedded
10. Stand-by circuit embedded
11. Power-on-reset circuit embedded
12. Soft-Start Limits Inrush Current
13. Effective illuminance range (3lx to 55000lx) (GA1A1S201WP)

■ Agency approvals/Compliance

1. Compliant with RoHS directive(2002/95/EC)

■ Applications

1. Back light and call alert display (White & RGB LED)

Notice The content of data sheet is subject to change without prior notice.

In the absence of confirmation by device specification sheets, SHARP takes no responsibility for any defects that may occur in equipment using any SHARP devices shown in catalogs, data books, etc. Contact SHARP in order to obtain the latest device specification sheets before using any SHARP device.

■ Block diagram

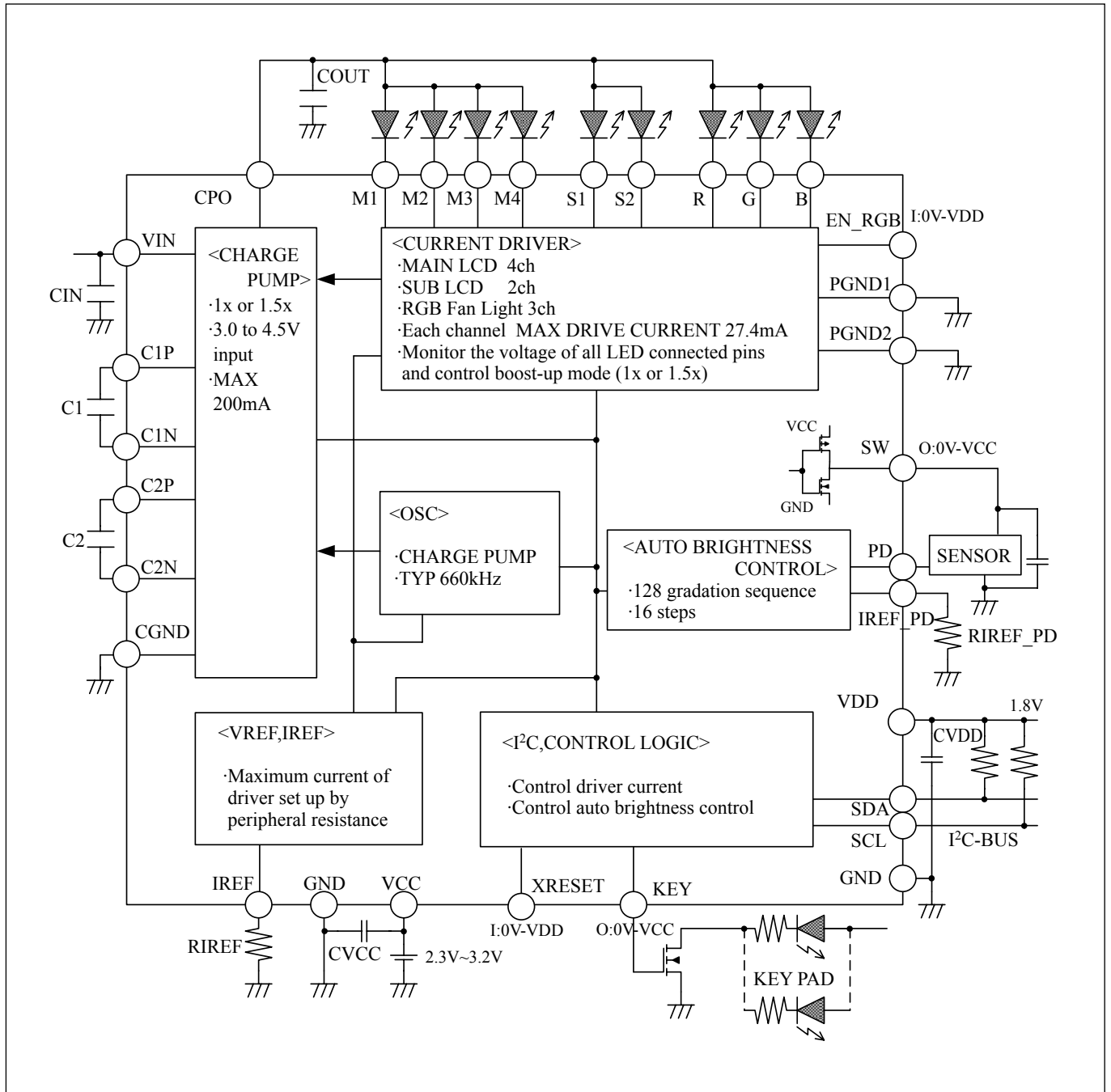

■ Outline Dimensions

(Unit : mm)

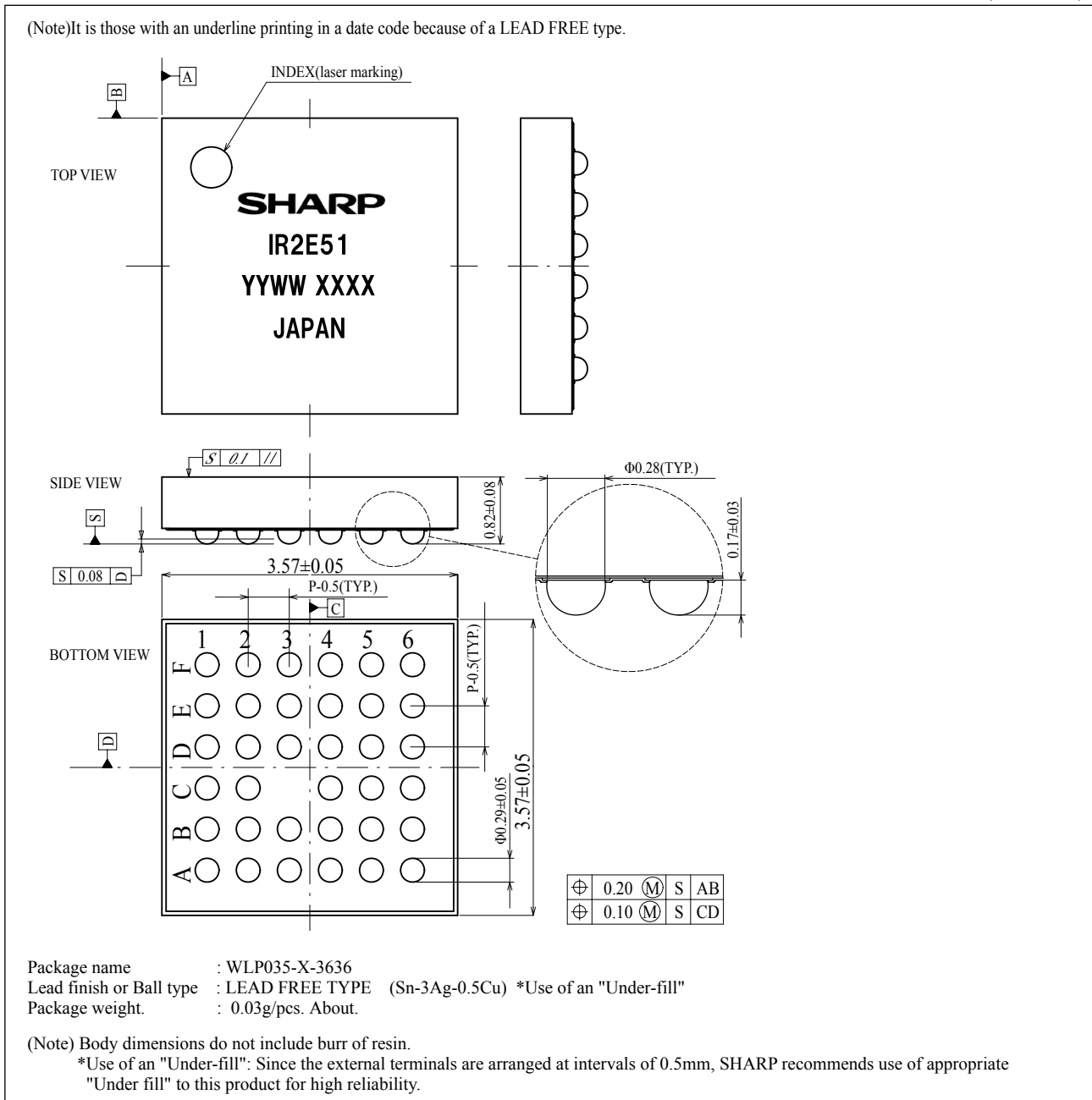

■ Markings.

- (1) Product name : IR2E51
- (2) Company name : SHARP
- (3) Date code : (Example) YYWW XXXX
 YY → Denotes the production year. (Last two digits of the year.)
 WW → Denotes the production week. (01 · 02 · ~ · 52 · 53)
 XXXX → Denotes the production ref. code.
- (4) "JAPAN" indicates the country of origin.

■ Terminal Name

Pin No	Pin name	Description
A1	U1A	Non-connect. This terminal is connected pin No. F1 (U1F).
A2	SW	Terminal of VCC output switch circuit for peripheral ambient light sensor.
A3	PD	Ambient light sensor terminal for auto brightness control (logarithmic output current type).
A4	VDD	Supply voltage for I ² C.
A5	SCL	I ² C clock input.
A6	U2A	Non-connect. This terminal is connected pin No. F6 (U2F).
B1	EN_RGB	Enable for RGB LED.
B2	IREF_PD	Resistor connection terminal for reference current setting of auto brightness control.
B3	VCC	Power supply terminal.
B4	SDA	I ² C data Input/Output terminal.
B5	KEY	Control signal output terminal which disables key pad LED.
B6	M2	Constant current output terminal for main LED2.
C1	G	Constant current output terminal for green LED.
C2	IREF	Resistor connection terminal for reference current setting of LED drivers.
C4	XRESET	Hard reset terminal.
C5	M1	Constant current output terminal for main LED1.
C6	PGND1	Main and sub LED driver ground.
D1	PGND2	RGB-LED driver ground.
D2	B	Constant current output terminal for blue LED.
D3	GND2	Ground terminal for control.
D4	GND1	Ground terminal for control.
D5	M3	Constant current output terminal for main LED3.
D6	M4	Constant current output terminal for main LED4.
E1	VIN	Power supply terminal for charge pump.
E2	R	Constant current output terminal for red LED.
E3	C1N	Flying capacitor 1 negative connection.
E4	S1	Constant current output terminal for sub LED1 (It can be used as main LED5).
E5	S2	Constant current output terminal for sub LED2 (It can be used as main LED6).
E6	CGND	Ground terminal for charge pump.
F1	U1F	Non-connect. This terminal is connected pin No. A1 (U1A).
F2	C1P	Flying capacitor 1 positive connection.
F3	CPO	Output voltage terminal of charge pump.
F4	C2P	Flying capacitor 2 positive connection.
F5	C2N	Flying capacitor 2 negative connection.
F6	U2F	Non-connect. This terminal is connected pin No. A6 (U2A).

■ Pin Assignment

	1	2	3	4	5	6
A	U1A	SW	PD	VDD	SCL	U2A
B	EN_RGB	IREF_PD	VCC	SDA	KEY	M2
C	G	IREF	X	XRESET	M1	PGND1
D	PGND2	B	GND2	GND1	M3	M4
E	VIN	R	C1N	S1	S2	CGND
F	U1F	C1P	CPO	C2P	C2N	U2F

Note: Pins are located on the underside.

■ Absolute Maximum Ratings

Parameter	Symbol	Rating	Unit	Conditions
Power supply	VIN	5.5	V	
Power supply	VCC	5.5	V	VCC ≤ VIN
Terminal voltage	VDD	-0.3V ~ VCC+0.3	V	
Terminal voltage1	Vin1	-0.3V ~ VDD+0.3	V	Input pin: EN_RGB,XRESET
Terminal voltage2	Vin2	-0.3V ~ VDD+0.3	V	Input pin: SCL,SDA
CPO output current	ICPO	220	mA	Total drive current
Output current	ILED	35/ch	mA	Each drive pin current
Power dissipation	Pd	1660	mW	Ta ≤ 25°C Note1
Derating ratio	ΔPd	16.6	mW/°C	Ta > 25°C Note1
Operating temperature range	Topr	-20 ~ 85	°C	
Storage temperature range	Tstg	-55 ~ 125	°C	

Note1: Free convection,on-board,compiled with SEMI42-996

■ Recommended Operating Condition

Parameter	Symbol	Value	Unit	Conditions
Power supply	VIN	3.0 ~ 4.5	V	
Power supply	VCC	2.3 ~ 3.2	V	
Terminal voltage	VDD	1.6 ~ VCC	V	
PD Pin input current	IPD	5 ~ 50	μA	Note:Correspond to logarithmic output current type ambient light sensor
		3 ~ 55000	lx	(Using sensor output:10*log(lx)[μA]) RIREF_PD=15kΩ
LED Output current	ILED	0.0 ~ 27.4	mA	RIREF=13kΩ
Oscillating frequency	fOSC	660	kHz	RIREF=13kΩ
I ² C communication frequency	fCLK	400	kHz	

■ Electric Characteristics

See the Block Diagram unless otherwise specified.

VIN=3.6V, VCC=2.5V, VDD=1.8V, Ta=25°C, RIREF=13kΩ, RIREF_PD=15kΩ

The current direction is regarded positive when entering the IC and negative when exiting.

Current consumption

Parameter	Symbol	Measurement condition	MIN.	TYP.	MAX.	Unit
Stand-by supply current	ISS1	XSTB="0"	-	0	3	μA
VIN Supply current	IIN1	VIN=4.2V, CPO output: 1x mode CPO output: No load current	-	0.17	0.32	mA
	IIN2	VIN=3V, CPO output: 1.5x mode CPO output: No load current	-	3.0	5.0	mA
VCC Supply current	ICC1	VCC=2.5V(IPD no input current)	-	0.7	1.5	mA
VDD Supply current	IVDD1	VCC=1.8V	-	0	3	μA

Voltage reference circuit

Parameter	Symbol	Measurement condition	MIN.	TYP.	MAX.	Unit
IREF Pin voltage	VREF	RIREF=13kΩ		480		mV
IREF_PD Pin voltage	VREF_PD	RIREF_PD=15kΩ		480		mV

Ambient light sensor interface circuit

Parameter	Symbol	Measurement condition	MIN.	TYP.	MAX.	Unit
Illuminance output data (8bit) (Offset adjustment=00H) (Slope adjustment=00H) RIREF_PD=15kΩ	Dout_PD0	PD pin current=0μA(open)		00H		
	Dout_PD1	PD pin current=10μA		34H		
	Dout_PD2	PD pin current=20μA		64H		
	Dout_PD3	PD pin current=30μA		94H		
	Dout_PD4	PD pin current=40μA		C8H		
	Dout_PD5	PD pin current=50μA		F8H		
Illuminance offset adjustment sensitivity (Offset adjustment for sensor dispersion) Slope adjustment=00H RIREF_PD=15kΩ	D_OFSET0	Offset adjustment: 00H		0		LSB
	D_OFSET+1	Offset adjustment:01H		+8		LSB
	D_OFSET+7	Offset adjustment:07H		+56		LSB
	D_OFSET-1	Offset adjustment:0FH		-8		LSB
	D_OFSET-8	Offset adjustment:08H		-64		LSB
Illuminance slope adjustment sensitivity (Slope adjustment for sensor dispersion) Offset adjustment=00H RIREF_PD=15kΩ	D_GAIN0	Offset adjustment:00H		0		%
	D_GAIN+1	Offset adjustment:01H		+3.13		%
	D_GAIN+7	Offset adjustment:07H		+21.90		%
	D_GAIN-1	Offset adjustment:0FH		-3.13		%
	D_GAIN-8	Offset adjustment:08H		-25.04		%

Constant current driver circuit

Parameter	Symbol	Measurement condition	MIN.	TYP.	MAX.	Unit
Main output current (M1 pin, M2 pin, M3 pin, M4 pin)	IM(7F)	Address 08H:7FH	24.66	27.40	30.14	mA
	IM(63)	Address 08H:63H	19.26	21.40	23.54	mA
	IM(31)	Address 08H:31H	9.63	10.70	11.77	mA
	IM(00)	Address 08H:00H	-	0.00	0.01	mA
Sub output current (S1 pin, S2 pin)	IS(7F)	Address 09H:7FH	24.66	27.40	30.14	mA
	IS(63)	Address 09H:63H	19.26	21.40	23.54	mA
	IS(31)	Address 09H:31H	9.63	10.70	11.77	mA
	IS(00)	Address 09H:00H	-	0.00	0.01	mA
R output current (R pin)	IR(7F)	Address 0AH:7FH	23.29	27.40	31.51	mA
	IR(63)	Address 0AH:63H	18.19	21.40	24.61	mA
	IR(31)	Address 0AH:31H	9.09	10.70	12.31	mA
	IR(00)	Address 0AH:00H	-	0.00	0.01	mA
G output current (G pin)	IG(7F)	Address 0BH:7FH	23.29	27.40	31.51	mA
	IG(63)	Address 0BH:63H	18.19	21.40	24.61	mA
	IG(31)	Address 0BH:31H	9.09	10.70	12.31	mA
	IG(00)	Address 0BH:00H	-	0.00	0.01	mA
B output current (B pin)	IB(7F)	Address 0CH:7FH	23.29	27.40	31.51	mA
	IB(63)	Address 0CH:63H	18.19	21.40	24.61	mA
	IB(31)	Address 0CH:31H	9.09	10.70	12.31	mA
	IB(00)	Address 0CH:00H	-	0.00	0.01	mA
LED drive pin Constant current1	Δ LED1	Voltage of current output pin: 0.35V~1.3V Output current: 20mA	-	\pm 1	\pm 5	%
LED drive pin Constant current2	Δ LED2	Voltage of current output pin: 0.35V~1.3V Output current : 4mA	-	\pm 1	\pm 5	%
Main output current relative margin	Δ IM	Voltage of current output pin: 0.8V Output current : 20mA		\pm 1	\pm 7.5	%
Sub output current relative margin	Δ IS	Voltage of current output pin: 0.8V Output current : 20mA		\pm 1	\pm 7.5	%
RGB output current relative margin	Δ IRGB	Voltage of current output pin: 0.8V Output current : 20mA		\pm 1	\pm 7.5	%

Charge pump circuit

Parameter	Symbol	Measurement condition	MIN.	TYP.	MAX.	Unit
CPO output impedance1	ZCPO1	VIN=4V, CP at 1x mode ZCPO1=(VIN-VCPO)/Iout		1.2		Ω
CPO output impedance2	ZCPO2	VIN=3V, CP 1.5x mode ZCPO2=(1.5×VIN-VCPO)/Iout		2.8		Ω
Oscillating frequency0	fOSC0cp	Address:00H(Initial value)	500	660	820	kHz

SDA pin, SCL pin, EN_RGB pin, XRESET pin

Parameter	Symbol	Measurement condition	MIN.	TYP.	MAX.	Unit
High level input voltage	VIH		0.7VDD	-	VDD	V
Low level input voltage	VIL		0	-	0.3VDD	V
High level input current	IIH		-1	-	1	μ A
Low level input current	IIL		-1	-	1	μ A
Hysteresis voltage	Vhys			0.05VDD		V
SDA output pin voltage	VOL	IOL=3mA	-	-	0.2VDD	V
Reset pulse width	PWre	XRESET of the period of "L"	10			μ s

KEY pin

Parameter	Symbol	Measurement condition	MIN.	TYP.	MAX.	Unit
KEY output pin voltage	VOH	IOH=100 μ A	VCC-0.6	VCC-0.3	-	V
KEY output pin voltage	VOL	IOL=100 μ A	-	0.3	0.6	V

SW pin

Parameter	Symbol	Measurement condition	MIN.	TYP.	MAX.	Unit
SW output pin voltage	VOH	IOH=500 μ A	VCC-0.2	VCC-0.1	-	V
SW output pin voltage	VOL	IOL=50 μ A	-	0.3	0.6	V

■ I²C-BUS Interface timing characteristics

All specified output timings are based on 20% and 80% of VDD

Fs-mode

Parameter	Symbol	conditions	MIN.	TYP.	MAX.	Unit
SCL clock frequency	f _{SCL}		0	-	400	kHz
Hold time(repeated) START condition	t _{HD} ;STA		600	-	-	ns
LOW period of the SCL clock	t _{LOW}		1300	-	-	ns
HIGH period of the SCL clock	t _{HIGH}		600	-	-	ns
Data set-up time	t _{SU} ;DAT		100	-	-	ns
Data hold time	t _{HD} ;DAT		0	-	-	ns
SCL and SDA rise time	t _r	Note 1.	20+0.1Cb	-	-	ns
SCL and SDA fall time	t _f	Note 1.	20+0.1Cb	-	-	ns
Capacitive load represented by each bus line	C _b		-	-	400	pF
Set-up time for STOP condition	t _{SU} ;STO		600	-	-	ns
Tolerable spike width on bus	t _{SP}		-	-	50	ns
Bus free time between START and STOP condition	t _{BUF}		1300	-	-	ns
Noise margin at the LOW level for each connected device (including hysteresis)	V _{nL}		0.1×VDD	-	-	V
Noise margin at the HIGH level for each connected device (including hysteresis)	V _{nH}		0.2×VDD	-	-	V

Hs-mode

Parameter	Symbol	conditions	MIN.	TYP.	MAX.	Unit
SCLH clock frequency	f _{SCLH}		0	-	3.4	MHz
Set-up time(repeated) START condition	t _{SU} ;STA		160	-	-	ns
Hold time(repeated) START condition	t _{HD} ;STA		160	-	-	ns
LOW period of the SCLH clock	t _{LOW}		160	-	-	ns
HIGH period of the SCLH clock	t _{HIGH}		60	-	-	ns
Data set-up time	t _{SU} ;DAT		10	-	-	ns
Data hold time	t _{HD} ;DAT		20	-	70	ns
Rise time of the SCLH signal	t _{rCL}		10	-	-	ns
Rise time of the SCLH signal after the acknowledge bit	t _{rCL1}		10	-	-	ns
Fall time of the SCLH signal	t _{fCL}		10	-	-	ns
Rise time of the SDAH signal	t _{rDA}		10	-	-	ns
Fall time of the SDAH signal	t _{fCL1}		10	-	-	ns
Set-up time for STOP condition	t _{SU} ;STO		160	-	-	ns
Capacitive load for the SDAH and SCLH lines	C _{b2}		-	-	100	pF
Capacitive load for the SDAH and SCLH lines	C _b		-	-	400	pF
Tolerable spike width on bus	t _{SP}		-	-	5	ns
Noise margin at the LOW level for each connected device (including hysteresis)	V _{nL}		0.1×VDD	-	-	V
Noise margin at the HIGH level for each connected device (including hysteresis)	V _{nH}		0.2×VDD	-	-	V

Note 1: C_b=100pF total capacitance of one bus line.

Fig.1 I²C-Bus timing diagram (Fs-mode)

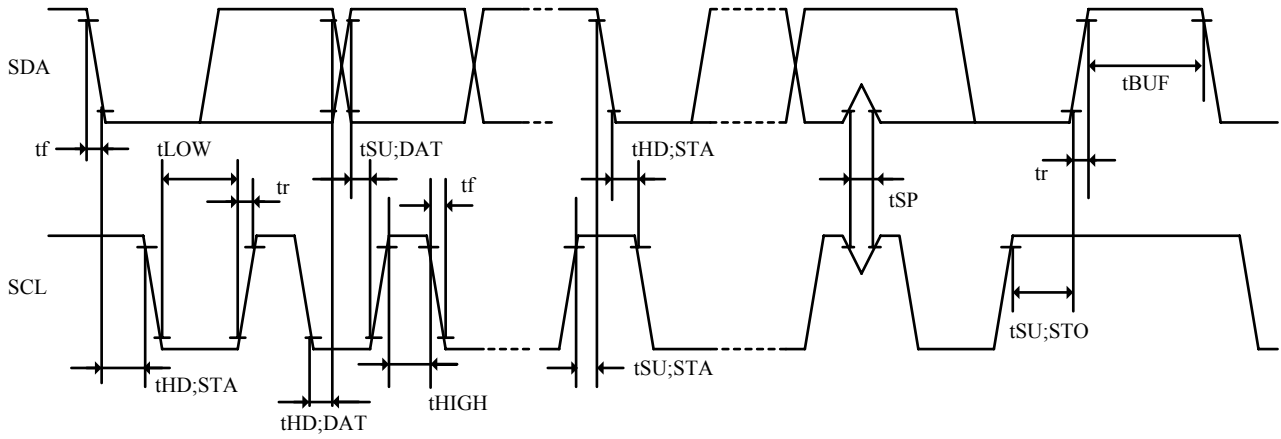
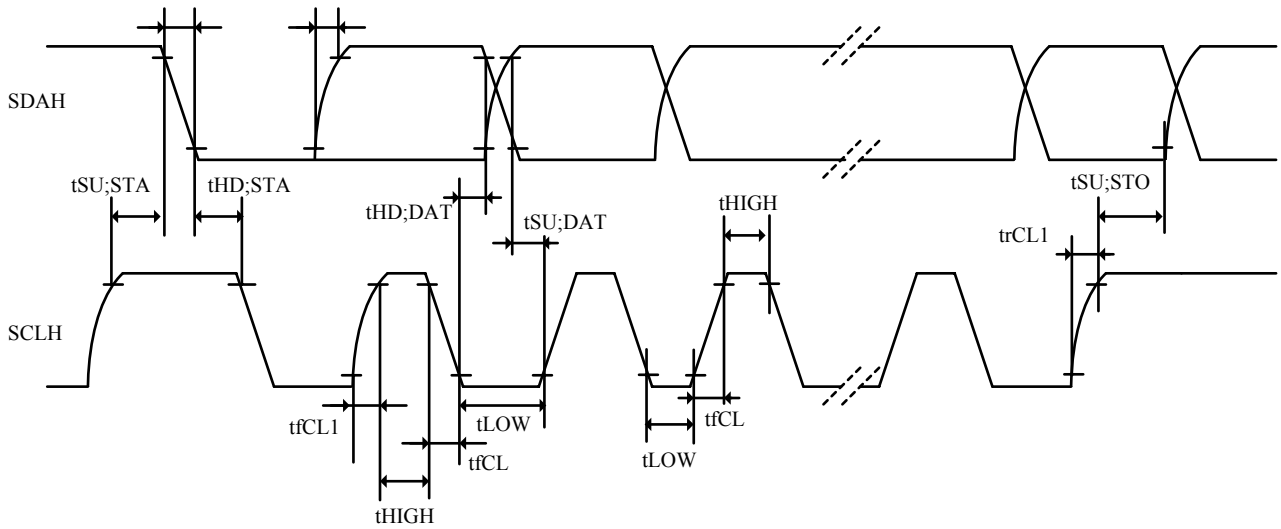

Fig.2 I²C-Bus timing diagram (Hs-mode)



■ Cautions

- Connect the ground pins (CGND, GND1, GND2, PGND1, PGND2) with the shortest distance and set pins same potential.
- It is recommended to install a capacitor between the power supply terminal and grounding terminal.
- Position a bypass capacitor between the power supply terminal and grounding pin close to the IC.
- Position a flying capacitor between the C1N-C1P pin and C2N-C2P pin close to the IC to reduce line resistance.
To reduce the line resistance and ESR (serial resistance of flying capacitor) makes drop voltage small and conversion efficiency improvement when charge pump is boost-up.
- Position a smoothing capacitor between CPO and GND pin close to the IC to reduce line resistance.
To reduce the line resistance and ESR (serial resistance of smoothing capacitor) makes drop voltage small and conversion efficiency improvement when charge pump is boost-up.
- Don't apply voltage CPO pin.
- Don't set input terminals (EN_RGB pin) floating.
- Supply input terminals (EN_RGB pin) with input voltage range specified electric characteristics.
- Use patterns as broad as and as short as possible for the power supply lines and grounding lines.
- In any case, use input voltage within the limits of maximum applied voltage.
- Position the IREF and IREF_PD pin close to the IC to circumvent the effect of noise.
- Connect driver terminal to ground when LED is unconnected. Other driver terminals should connect LED between CPO terminals.
- Don't put in strong light against IC when you use this IC.
- It is recommended that the output line of the ambient light sensor is inserted by ground line for protection from noises.
- It is recommended to insert a capacitor between the sensor's power supply terminal and sensor's ground terminal near the sensor.
- It is recommended to reset IC after setting VCC to "H".

■ Important Notices

· The circuit application examples in this publication are provided to explain representative applications of SHARP devices and are not intended to guarantee any circuit design or license any intellectual property rights. SHARP takes no responsibility for any problems related to any intellectual property right of a third party resulting from the use of SHARP's devices.

· Contact SHARP in order to obtain the latest device specification sheets before using any SHARP device. SHARP reserves the right to make changes in the specifications, characteristics, data, materials, structure, and other contents described herein at any time without notice in order to improve design or reliability. Manufacturing locations are also subject to change without notice.

· Observe the following points when using any devices in this publication. SHARP takes no responsibility for damage caused by improper use of the devices which does not meet the conditions and absolute maximum ratings to be used specified in the relevant specification sheet nor meet the following conditions:

(i) The devices in this publication are designed for use in general electronic equipment designs such as:

- Personal computers
- Office automation equipment
- Telecommunication equipment [terminal]
- Test and measurement equipment
- Industrial control
- Audio visual equipment
- Consumer electronics

(ii) Measures such as fail-safe function and redundant design should be taken to ensure reliability and safety when SHARP devices are used for or in connection

with equipment that requires higher reliability such as:

- Transportation control and safety equipment (i.e., aircraft, trains, automobiles, etc.)
- Traffic signals
- Gas leakage sensor breakers
- Alarm equipment
- Various safety devices, etc.

(iii) SHARP devices shall not be used for or in connection with equipment that requires an extremely high level of reliability and safety such as:

- Space applications
- Telecommunication equipment [trunk lines]
- Nuclear power control equipment
- Medical and other life support equipment (e.g., scuba).



· If the SHARP devices listed in this publication fall within the scope of strategic products described in the Foreign Exchange and Foreign Trade Law of Japan, it is necessary to obtain approval to export such SHARP devices.

· This publication is the proprietary product of SHARP and is copyrighted, with all rights reserved. Under the copyright laws, no part of this publication may be reproduced or transmitted in any form or by any means, electronic or mechanical, for any purpose, in whole or in part, without the express written permission of SHARP. Express written permission is also required before any use of this publication may be made by a third party.

· Contact and consult with a SHARP representative if there are any questions about the contents of this publication.

Looking for pricing, stock, or lifecycle information?

Click below to explore more details on WIN SOURCE:

-  [View IR2E51Y6 on WIN SOURCE](#)
-  [Sharp Microelectronics](#) Information

Optimize Your Supply Chain with WIN SOURCE Solutions

-  Global Sourcing Solution
-  Obsolete Management
-  Cost Control Management
-  Shortage Management
-  Alternative Solution
-  Excess Inventory Management