



THE DATASHEET OF ERA-21SM+



Product Features

- DC-8 GHz
- Single Voltage Supply
- Internally Matched to 50 Ohms
- Unconditionally Stable
- Low Performance Variation Over Temperature
- Transient Protected
- Aqueous washable
- Protected By US Patent 6,943,629
- Low additive phase noise, typically -170 dBc/Hz @ 10 KHz offset



Generic photo used for illustration purposes only

ERA-21SM+

CASE STYLE: WW107

+RoHS Compliant

The +Suffix identifies RoHS Compliance. See our web site for RoHS Compliance methodologies and qualifications

Typical Applications

- Cellular/ PCS/ 3G Base Station
- CATV, Cable Modem & DBS
- Fixed Wireless & WLAN
- Microwave Radio & Test Equipment
- Suitable for low phase noise applications

General Description

ERA-21SM+ (RoHS compliant) is a wideband amplifier offering high dynamic range. It has repeatable performance from lot to lot. It is enclosed in an Micro-X package. ERA-21SM+ uses Darlington configuration and is fabricated using InGaP HBT technology. Expected MTTF is 3,700 years at 85°C case temperature.

simplified schematic and pin description

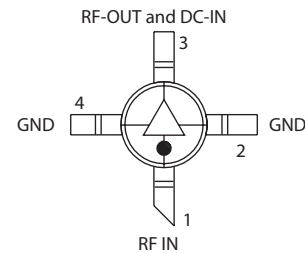
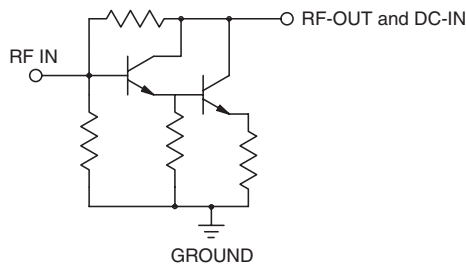

Function	Pin Number	Description
RF IN	1	RF input pin. This pin requires the use of an external DC blocking capacitor chosen for the frequency of operation.
RF-OUT and DC-IN	3	RF output and bias pin. DC voltage is present on this pin; therefore a DC blocking capacitor is necessary for proper operation. An RF choke is needed to feed DC bias without loss of RF signal due to the bias connection, as shown in "Recommended Application Circuit".
GND	2,4	Connections to ground. Use via holes as shown in "Suggested Layout for PCB Design" to reduce ground path inductance for best performance.

Notes

- A. Performance and quality attributes and conditions not expressly stated in this specification document are intended to be excluded and do not form a part of this specification document.
 B. Electrical specifications and performance data contained in this specification document are based on Mini-Circuit's applicable established test performance criteria and measurement instructions.
 C. The parts covered by this specification document are subject to Mini-Circuits standard limited warranty and terms and conditions (collectively, "Standard Terms"); Purchasers of this part are entitled to the rights and benefits contained therein. For a full statement of the Standard Terms and the exclusive rights and remedies thereunder, please visit Mini-Circuits' website at www.minicircuits.com/MCLStore/terms.jsp



Electrical Specifications at 25°C and 40mA, unless noted

Parameter		Min.	Typ.	Max.	Units	Cpk
Frequency Range*		DC		8	GHz	
Gain	f=0.1 GHz	13.5	14.2	15	dB	≥ 1.5
	f=1 GHz	—	13.9	—		
	f=2 GHz	11.2	13.2	13.9		
	f=3 GHz	—	12.2	—		
	f=4 GHz	9.9	10.8	11.5		
	f=6 GHz	—	8.7	—		
	f=8 GHz	—	8.9	—		
Magnitude of Gain Variation versus Temperature (values are negative)	f=0.1 GHz	—	.0005	.002	dB/°C	
	f=1 GHz	—	.0011	.003		
	f=2 GHz	—	.0015	.003		
	f=3 GHz	—	.0022	.005		
	f=4 GHz	—	.0029	.006		
	f=6 GHz	—	.0043	.01		
	f=8 GHz	—	.0056	.012		
Input Return Loss	f=0.1 GHz		31		dB	
	f=1 GHz		31			
	f=2 GHz		23			
	f=3 GHz		20			
	f=4 GHz		18			
	f=6 GHz		13			
	f=8 GHz		8.5			
Output Return Loss	f=0.1 GHz		33		dB	
	f=1 GHz		23			
	f=2 GHz		20			
	f=3 GHz		20			
	f=4 GHz		19			
	f=6 GHz		16			
	f=8 GHz		12			
Reverse Isolation	f=1.0 GHz	15	19	—	dB	
Output Power @ 1 dB compression	f=0.1 GHz	—	12.8	—	dBm	≥ 1.33
	f=1 GHz	—	12.6	—		
	f=2 GHz	10.6	12.6	—		
	f=3 GHz	—	12.6	—		
	f=4 GHz	—	12.1	—		
	f=6 GHz	—	10	—		
	f=8 GHz	—	8	—		
Saturated Output Power (at 3dB compression)	f=0.1 GHz		13.2		dBm	
	f=1 GHz		12.8			
	f=2 GHz		13.1			
	f=3 GHz		12.9			
	f=4 GHz		13.2			
	f=6 GHz		12.6			
	f=8 GHz		11.1			

Notes

- A. Performance and quality attributes and conditions not expressly stated in this specification document are intended to be excluded and do not form a part of this specification document.
- B. Electrical specifications and performance data contained in this specification document are based on Mini-Circuit's applicable established test performance criteria and measurement instructions.
- C. The parts covered by this specification document are subject to Mini-Circuits standard limited warranty and terms and conditions (collectively, "Standard Terms"); Purchasers of this part are entitled to the rights and benefits contained therein. For a full statement of the Standard Terms and the exclusive rights and remedies thereunder, please visit Mini-Circuits' website at www.minicircuits.com/MCLStore/terms.jsp



Electrical Specifications at 25°C and 40mA, unless noted

Parameter		Min.	Typ.	Max.	Units	Cpk
Output IP3	f=0.1 GHz	27	29	—	dBm	≥ 1.33
	f=1 GHz	—	29	—		
	f=2 GHz	25	28	—		
	f=3 GHz	—	27	—		
	f=4 GHz	22	25	—		
	f=6 GHz	—	23	—		
	f=8 GHz	—	20	—		
Noise Figure	f=0.1 GHz	—	3.4	4.4	dB	≥ 1.33
	f=1 GHz	—	3.4	—		
	f=2 GHz	—	3.3	4.3		
	f=3 GHz	—	3.4	—		
	f=4 GHz	—	3.7	4.7		
	f=6 GHz	—	4.3	—		
	f=8 GHz	—	5.0	—		
Additive Phase Noise	2 GHz, 10 KHz offset	—	-170	—	dBc/Hz	
Group Delay	f=2 GHz		80		psec	
Recommended Device Operating Current			40		mA	
Device Operating Voltage		3.2	3.5	3.8	V	≥ 1.5
Device Voltage Variation vs. Temperature at 40mA			-2.3		mV/°C	
Device Voltage Variation vs. Current at 25°C			8.8		mV/mA	
Thermal Resistance, junction-to-case ¹			194		°C/W	

*Guaranteed specification DC-8 GHz. Low frequency cut off determined by external coupling capacitors.

Absolute Maximum Ratings

Parameter	Ratings
Operating Temperature*	-45°C to 85°C
Storage Temperature	-65°C to 150°C
Operating Current	75mA
Power Dissipation	330mW
Input Power	15dBm

Note: Permanent damage may occur if any of these limits are exceeded.

These ratings are not intended for continuous normal operation.

¹Case is defined as ground leads.

*Based on typical case temperature rise 5°C above ambient.

Notes

A. Performance and quality attributes and conditions not expressly stated in this specification document are intended to be excluded and do not form a part of this specification document.

B. Electrical specifications and performance data contained in this specification document are based on Mini-Circuit's applicable established test performance criteria and measurement instructions.

C. The parts covered by this specification document are subject to Mini-Circuits standard limited warranty and terms and conditions (collectively, "Standard Terms"); Purchasers of this part are entitled to the rights and benefits contained therein. For a full statement of the Standard Terms and the exclusive rights and remedies thereunder, please visit Mini-Circuits' website at www.minicircuits.com/MCLStore/terms.jsp



Product Marking

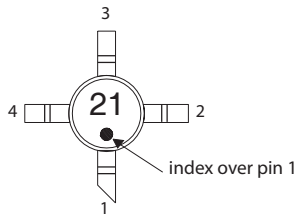

Markings in addition to model number designation may appear for internal quality control purposes.

Additional Detailed Technical Information

Additional information is available on our web site. To access this information enter the model number on our web site home page.

Performance data, graphs, s-parameter data set (.zip file)

Case Style: WW107

Plastic micro-x, .085 body diameter, lead finish: matte-tin

Tape & Reel: F4

7" Reels with 20, 50, 100, 200, 500, 1K devices

Suggested Layout for PCB Design: PL-075

Evaluation Board: TB-408-21+

Environmental Ratings: ENV08T2

Recommended Application Circuit

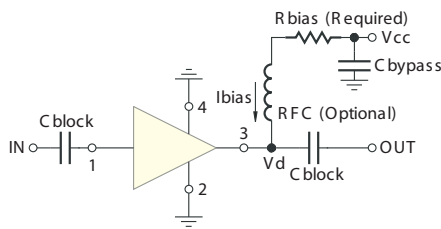

Test Board includes case, connectors, and components (in bold) soldered to PCB

R BIAS	
Vcc	"1%" Res. Values (ohms) for Optimum Biasing
7	88.7
8	113
9	137
10	162
11	187
12	210
13	237
14	261
15	287
16	316
17	340
18	365
19	392
20	412

Notes

- A. Performance and quality attributes and conditions not expressly stated in this specification document are intended to be excluded and do not form a part of this specification document.
- B. Electrical specifications and performance data contained in this specification document are based on Mini-Circuit's applicable established test performance criteria and measurement instructions.
- C. The parts covered by this specification document are subject to Mini-Circuits standard limited warranty and terms and conditions (collectively, "Standard Terms"); Purchasers of this part are entitled to the rights and benefits contained therein. For a full statement of the Standard Terms and the exclusive rights and remedies thereunder, please visit Mini-Circuits' website at www.minicircuits.com/MCLStore/terms.jsp



ESD Rating

Human Body Model (HBM): Class 1B (500 v to < 1000 v) in accordance with ANSI/ESD STM 5.1 - 2001

Machine Model (MM): Class M1 (< 100 v) in accordance with ANSI/ESD STM 5.2 - 1999

MSL Rating

Moisture Sensitivity: MSL1 in accordance with IPC/JEDECJ-STD-020C

No.	Test Required	Condition	Standard	Quantity
1	Visual Inspection	Low Power Microscope Magnification 40x	MIP-IN-0003 (MCT spec)	45 units
2	Electrical Test	Room Temperature	SCD (MCL spec)	45 units
3	SAM Analysis	Less than 10% growth in term of delamination	J-Std-020C (Jedec Standard)	45 units
4	Moisture Sensitivity Level 1	Bake at 125°C for 24 hours Soak at 85°C/85%RH for 168 hours Reflow 3 cycles at 260°C peak	J-Std-020C (Jedec Standard)	45 units

MSL Test Flow Chart

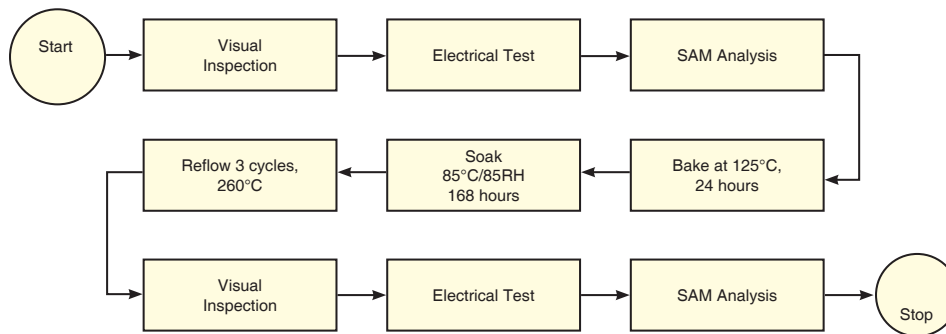



Notes

- A. Performance and quality attributes and conditions not expressly stated in this specification document are intended to be excluded and do not form a part of this specification document.
- B. Electrical specifications and performance data contained in this specification document are based on Mini-Circuit's applicable established test performance criteria and measurement instructions.
- C. The parts covered by this specification document are subject to Mini-Circuits standard limited warranty and terms and conditions (collectively, "Standard Terms"); Purchasers of this part are entitled to the rights and benefits contained therein. For a full statement of the Standard Terms and the exclusive rights and remedies thereunder, please visit Mini-Circuits' website at www.minicircuits.com/MCLStore/terms.jsp



Looking for pricing, stock, or lifecycle information?

Click below to explore more details on WIN SOURCE:

-  [View ERA-21SM+ on WIN SOURCE](#)
-  [Mini-Circuits Information](#)

Optimize Your Supply Chain with WIN SOURCE Solutions

-  Global Sourcing Solution
-  Obsolete Management
-  Cost Control Management
-  Shortage Management
-  Alternative Solution
-  Excess Inventory Management