



**THE DATASHEET OF  
EM6325CXSP5B-2.9+**





# Reset Circuit with Manual Reset

## Description

The EM6325 is an ultra-low current reset circuit available in a large variety of configurations and very small packages for maximum flexibility in all end-applications up to 125°C and using power supplies between 1.5V and 5.5V.

This circuit monitors the supply voltage of any electronic system, and generates the appropriate reset signal after a fixed reset timeout period. The threshold defines the minimum allowed voltage which guarantees the good functionality of the system. When  $V_{DD}$  rises above  $V_{TH}$ , the output remains active for an additional delay time. This allows the system to stabilize before getting fully active.

This circuit features a Manual Reset: an input that asserts reset when pulled low ( $\overline{MR}$  with internal pull-up).

Small SOT23-5L package as well as ultra-low supply current of 2.9µA make the EM6325 an ideal choice for portable and battery-operated devices.

## Typical Application

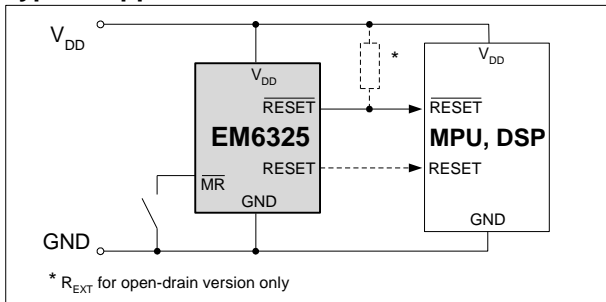

## Block Diagram

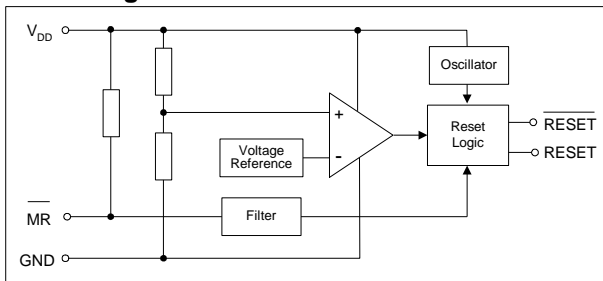

## Features

- ❑ Manual reset function
- ❑ 200ms reset timeout period (1.6ms, 25ms, 1600ms on request)
- ❑ Ultra-low supply current of 2.9µA ( $V_{DD}=3.3V$ )
- ❑ Operating temperature range: -40°C to +125°C
- ❑ ±1.5% reset threshold accuracy
- ❑ 11 reset threshold voltages  $V_{TH}$ : 4.63V, 4.4V, 3.08V, 2.93V, 2.63V, 2.2V, 1.8V, 1.66V, 1.57V, 1.38V, 1.31V
- ❑ 2 reset output options:
  - Active-low  $\overline{RESETE}$  push-pull
  - Active-low  $\overline{RESETE}$  open-drain
- ❑ Immune to short negative  $V_{DD}$  transients
- ❑ Guaranteed Reset valid down to 0.9V
- ❑ Threshold hysteresis: 2.1% of  $V_{TH}$
- ❑ Very small SOT23-5L, SOT143-4L

## Applications

- ❑ Computers
- ❑ Servers and workstations
- ❑ Modems
- ❑ Wireless communication
- ❑ Metering
- ❑ Playstations
- ❑ PDA, Webpad

## Pin Configuration (top view)

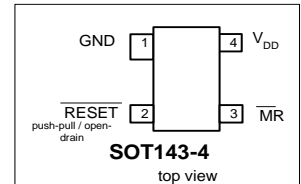
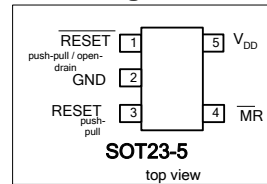

## Pin Description

Pin		Name	Function
SOT23-5L	SOT143-4L		
1	2	$\overline{RESETE}$	Active-low $\overline{RESETE}$ output. $\overline{RESETE}$ remains low for the reset timeout period and then goes high after all reset conditions are deasserted or after $\overline{MR}$ goes from low to high
2	1	GND	Ground
3		RESET	Active-high RESET output. RESET remains high for the reset timeout period and then goes low after all reset conditions are deasserted or after $\overline{MR}$ goes from low to high
4	3	$\overline{MR}$	Manual Reset input with an internal pull-up 15kΩ resistor. Reset remains active as long as $\overline{MR}$ is low and for $t_{POR}$ after $\overline{MR}$ returns high. $\overline{MR}$ can be driven with a CMOS output or shorted to ground with a switch
5	4	$V_{DD}$	Supply Voltage (5.5V max.)



Ordering Information

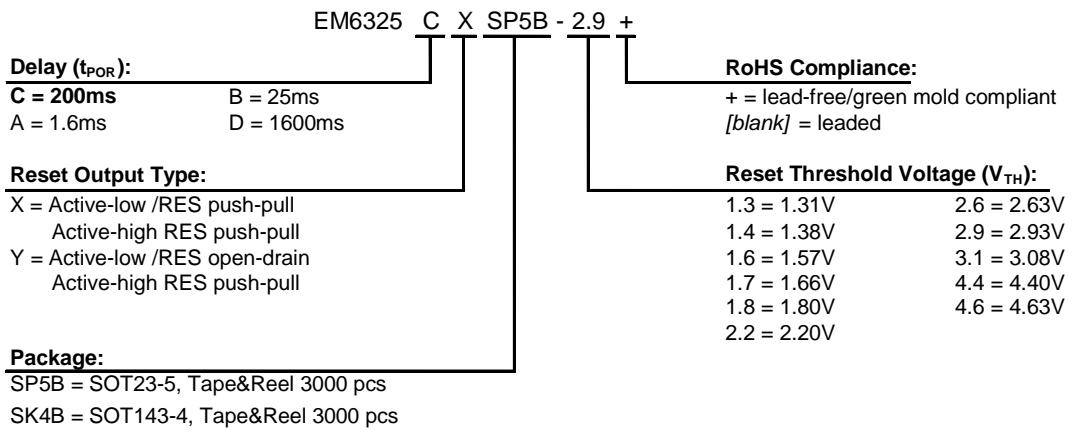

Standard Versions (Top Marking)

Part Number	Top Marking <sup>1)</sup>	Top Marking <sup>2)</sup> with 4 Characters
EM6325AXSP5B-2.9+	CN##	BNAH
EM6325CXSP5B-1.3+	CP##	BNCA
EM6325CXSP5B-2.6+	CS##	BNCG
EM6325CXSP5B-2.9+	BZ##	BNCH
EM6325CXSP5B-3.1+	CT##	BNCJ
EM6325CXSP5B-4.6+	C3##	BNCL
EM6325CYSP5B-2.9+	BY##	BNCU
EM6325CYSP5B-4.6+	C0##	BNCX
EM6325CXSK4B-2.9+	CR##	

- 1) Top marking is the standard from 2006. No bottom marking exists. Where ## refers to the lot number (EM internal reference only)
- 2) Top marking with 4 characters is standard from 2003. For lead-free/green mold (RoHS) parts, the first letter of top marking with 4 characters begins with letter "B" instead of letter "A". Bottom marking indicates the lot number.

Standard Versions (samples)

Part Number
EM6325AXSP5B-2.9+
EM6325CXSP5B-1.3+
EM6325CXSK4B-2.9+
EM6325CXSP5B-2.6+
EM6325CXSP5B-2.9+

Part Number
EM6325CXSP5B-3.1+
EM6325CXSP5B-4.6+
EM6325CYSP5B-2.6+
EM6325CYSP5B-4.6+

Sample stock is generally held on **standard versions** only. Please contact factory for other versions not shown here and for availability of non standard versions.



**Absolute Maximum Ratings**

Parameter	Symbol	Conditions
Voltage at V <sub>DD</sub> to GND	V <sub>DD</sub>	-0.3V to +6V
Minimum voltage at any signal pin	V <sub>MIN</sub>	GND - 0.3V
Maximum voltage at any signal pin	V <sub>MAX</sub>	V <sub>DD</sub> + 0.3V
Electrostatic discharge max. to MIL-STD-883C method 3015.7 with ref. to V <sub>SS</sub>	V <sub>ESD</sub>	2000V
Max. soldering conditions	T <sub>MAX</sub>	250°C x 10s
Storage Temperature Range	T <sub>STG</sub>	-65°C to +150°C

Stresses above these listed maximum ratings may cause permanent damages to the device. Exposure beyond specified operating conditions may affect device reliability or cause malfunction.

**Handling Procedures**

This device has built-in protection against high static voltages or electric fields; however, anti-static precautions must be taken as for any other CMOS component. Unless otherwise specified, proper operation can only occur when all terminal voltages are kept within the voltage range. Unused inputs must always be tied to a defined logic voltage level.

**Operating Conditions**

Parameter	Symbol	Min	Max	Unit
Supply voltage	V <sub>DD</sub>	0.9	5.5	V
Operating Temperature	T <sub>A</sub>	-40	+125	°C

**Electrical Characteristics**

Unless otherwise specified: V<sub>DD</sub>= 0.9V to 5.5V, T<sub>A</sub>=-40°C to +125°C (note 1).

Parameter	Symbol	Conditions	Min	Typ	Max	Unit			
Supply current (note 2)	I <sub>DD</sub>	V <sub>DD</sub> =1.5V	+25°C	-	2.3	4.6	µA		
			-40°C to +125°C	-	-	7			
		V <sub>DD</sub> =3.3V	+25°C	-	2.9	5.5			
			-40°C to +125°C	-	-	8.3			
		V <sub>DD</sub> =5.0V	+25°C	-	3.4	6.3			
			-40°C to +125°C	-	-	9.6			
Threshold voltage (note 3)	V <sub>TH</sub>	EM6325 – 1.3	+25°C	1.290	1.31	1.330	V		
			-40°C to +85°C	1.245		1.382			
			-40°C to +125°C	1.221		1.387			
		EM6325 – 1.4	+25°C	1.359	1.38	1.401			
			-40°C to +85°C	1.311		1.456			
			-40°C to +125°C	1.286		1.461			
		EM6325 – 1.6	+25°C	1.546	1.57	1.594			
			-40°C to +85°C	1.492		1.656			
			-40°C to +125°C	1.463		1.663			
		EM6325 – 1.7	+25°C	1.635	1.66	1.685			
			-40°C to +85°C	1.577		1.751			
			-40°C to +125°C	1.547		1.758			
		EM6325 – 1.8	+25°C	1.773	1.80	1.827			
			-40°C to +85°C	1.710		1.899			
			-40°C to +125°C	1.678		1.906			
		EM6325 – 2.2	+25°C	2.167	2.20	2.233			
			-40°C to +85°C	2.090		2.321			
			-40°C to +125°C	2.050		2.330			
		EM6325 – 2.6	+25°C	2.591	2.63	2.669			
			-40°C to +85°C	2.499		2.775			
			-40°C to +125°C	2.451		2.785			
		EM6325 – 2.9	+25°C	2.886	2.93	2.974			
			-40°C to +85°C	2.784		3.091			
			-40°C to +125°C	2.731		3.103			
		EM6325 – 3.1	+25°C	3.034	3.08	3.126			
			-40°C to +85°C	2.926		3.249			
			-40°C to +125°C	2.871		3.262			
		EM6325 – 4.4	+25°C	4.334	4.40	4.466			
			-40°C to +85°C	4.180		4.642			
			-40°C to +125°C	4.101		4.660			
		EM6325 – 4.6	+25°C	4.561	4.63	4.699			
			-40°C to +85°C	4.399		4.885			
			-40°C to +125°C	4.315		4.903			
		Threshold hysteresis	V <sub>HYS</sub>	T <sub>A</sub> =+25°C	-	2.1%•V <sub>TH</sub>		-	V

**Note 1:** Production tested at +25°C only. Over temperature limits are guaranteed by design, not production tested.

**Note 3:** Threshold voltage is specified for V<sub>DD</sub> falling.



**Electrical Characteristics** (continued)

Unless otherwise specified:  $V_{DD}= 0.9V$  to  $5.5V$ ,  $T_A=-40^{\circ}C$  to  $+125^{\circ}C$  (note 1).

Parameter	Symbol	Conditions	Min	Typ	Max	Unit	
Reset timeout period	$t_{POR}$	(note 2 and 4) $V_{DD}$ from 0V to $V_{TH (typ)}+15\%$ $T_A= +25^{\circ}C$	EM6325C	155	200	224	ms
			EM6325A	0.7	1.6	3.8	
			EM6325B	19.4	25	28	
			EM6325D	1240	1600	1792	
Propagation delay time $V_{DD}$ to $\overline{RESET}$ (RESET) delay	$t_p$	$V_{DD}$ drops from $V_{TH (typ)}+0.2V$ to $V_{TH (typ)}-0.2V$ (note 2). $T_A= +25^{\circ}C$	2	130	255	$\mu s$	
Open-drain $\overline{RESET}$ output Voltage	$V_{OL}$	$V_{DD}>1V$	$I_{OL}=100\mu A$	-	-	0.3	V
		$V_{DD}>2.5V$	$I_{OL}=1.5mA$	-	-	0.3	
		$V_{DD}>5V$	$I_{OL}=3mA$	-	-	0.35	
Push-pull $\overline{RESET}$ / $\overline{RESET}$ Output voltage	$V_{OL}$	$V_{DD}>1V$	$I_{OL}=100\mu A$	-	-	0.3	V
		$V_{DD}>2.5V$	$I_{OL}=1.5mA$	-	-	0.3	
		$V_{DD}>5V$	$I_{OL}=3mA$	-	-	0.35	
	$V_{OH}$	$V_{DD}>1V$	$I_{OH}=-30\mu A$	0.8	-	-	
		$V_{DD}>2.5V$	$I_{OH}=-1.5mA$	2	-	-	
		$V_{DD}>5V$	$I_{OH}=-3mA$	4	-	-	
Output leakage current	$I_{LEAK}$	Only for EM6325_Y (open-drain)	-	-	0.5	$\mu A$	
<b>MANUAL RESET (MR)</b>							
$\overline{MR}$ Input low	$V_{MRT low}$	$T_A= +25^{\circ}C$			$0.3 \cdot V_{DD}$	V	
$\overline{MR}$ Input high	$V_{MRT high}$		$0.7 \cdot V_{DD}$			V	
$\overline{MR}$ to Reset delay	$t_{MD}$			0.3		$\mu s$	
Pulse width at $\overline{MR}$ (note 5)	$t_{PMD}$		1			$\mu s$	
$\overline{MR}$ Internal Pull-up resistor	$R_{MR}$	$T_A=-40^{\circ}C$ to $+125^{\circ}C$	4.8	15	31	$k\Omega$	

**Note 1:** Production tested at  $+25^{\circ}C$  only. Over temperature limits are guaranteed by design, not production tested.

**Note 2:**  $\overline{RESET}$  (RESET) open.

**Note 4:** Standard version for  $t_{POR}$  is 200ms (typ), available at all times. Other option (1.6ms, 25ms, 1600ms) are available by mask option and upon minimum order quantity. Please contact EM sales.

**Note 5:** Pulse width must be greater than  $1\mu s$  to ensure the  $\overline{RESET}$  (RESET) to go active.

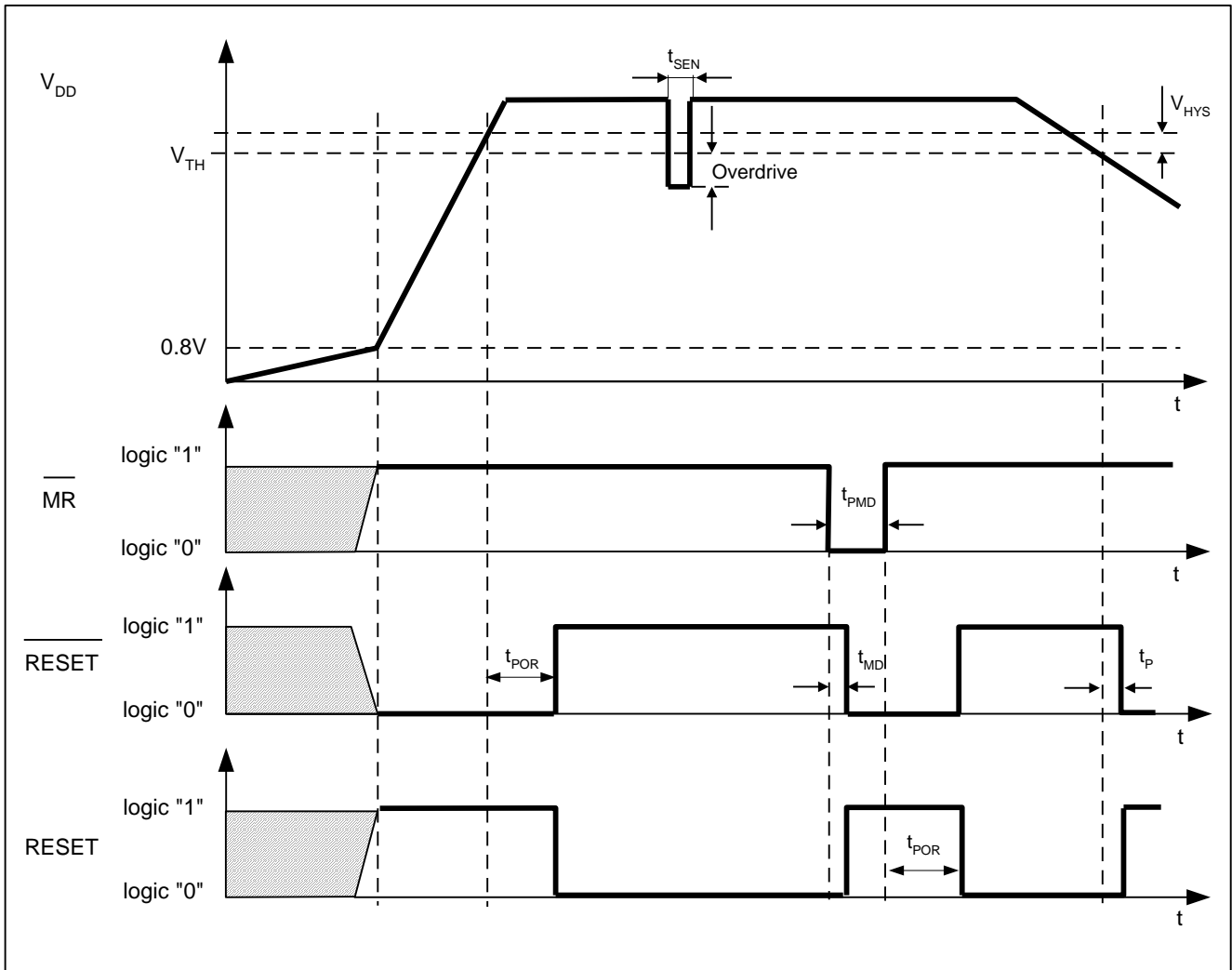
**Timing Waveforms**

**Note 6:** t<sub>SEN</sub> = Maximum Transient Duration. Please refer to figure on the next page.

**Note 7:** Overdrive = V<sub>TH</sub> - V<sub>DD</sub>. Please refer to figure on the next page.

**Manual Reset Input**

A logic low on  $\overline{\text{MR}}$  asserts a reset. Reset remains asserted while  $\overline{\text{MR}}$  is low, and for t<sub>POR</sub> (200ms nominal for EM6325C) after it returns high.  $\overline{\text{MR}}$  has an internal 15kΩ pull-up resistor, so it can be left open if unused. This input can be driven with CMOS logic levels or with open-drain outputs. Connect a normally open momentary switch from  $\overline{\text{MR}}$  to V<sub>SS</sub> to create a manual-reset function; debounce circuitry is integrated. If  $\overline{\text{MR}}$  is driven from long cable or the device is used in a noisy environment, connect a 0.1μF capacitor from  $\overline{\text{MR}}$  to V<sub>SS</sub> to provide additional noise immunity (stronger external additional pull-up resistor can also be added).

**Typical Operating Characteristics**

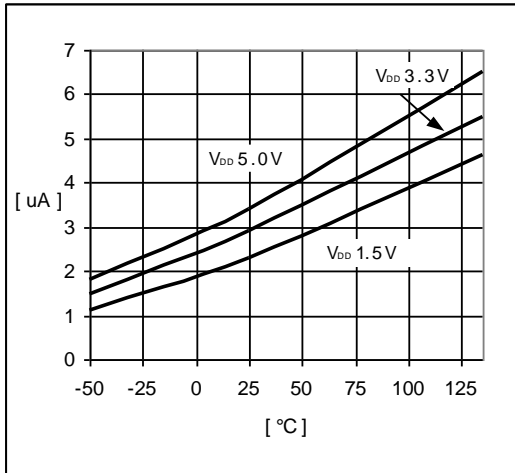
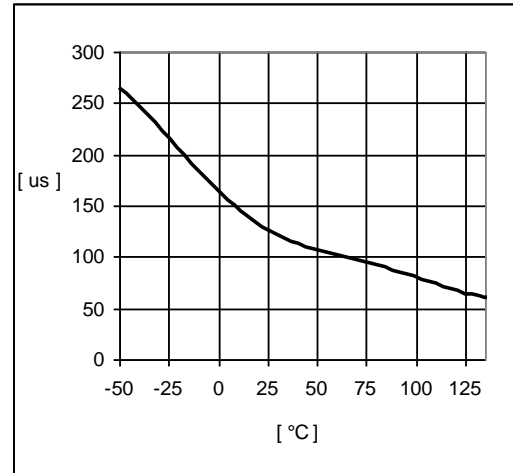
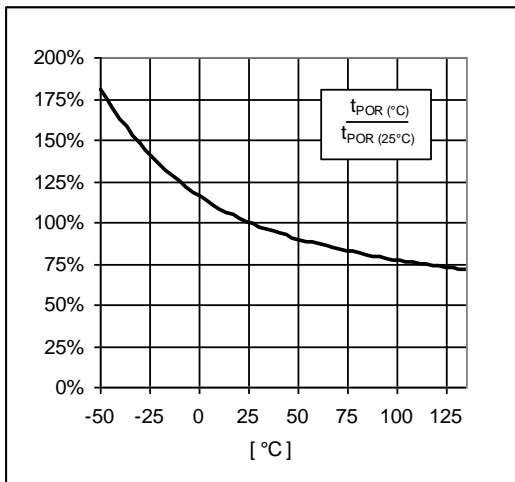
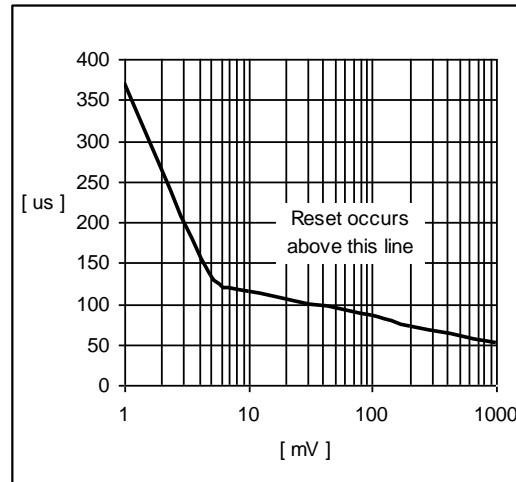
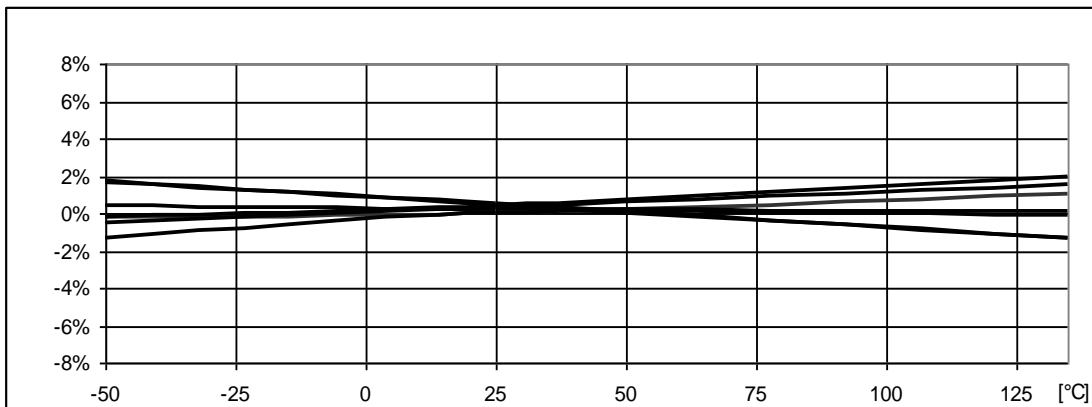
 (Typical values are at  $T_A=+25^\circ\text{C}$  unless otherwise noted,  $\overline{\text{MR}}$ ,  $\overline{\text{RESET}}$  and RESET open.)

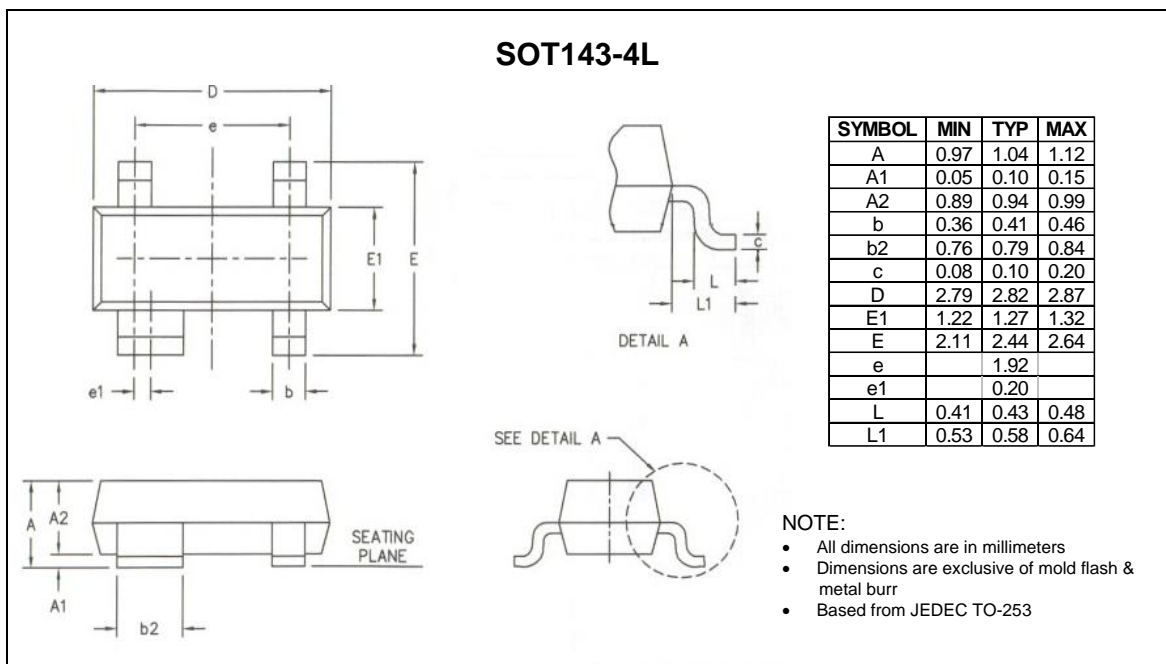
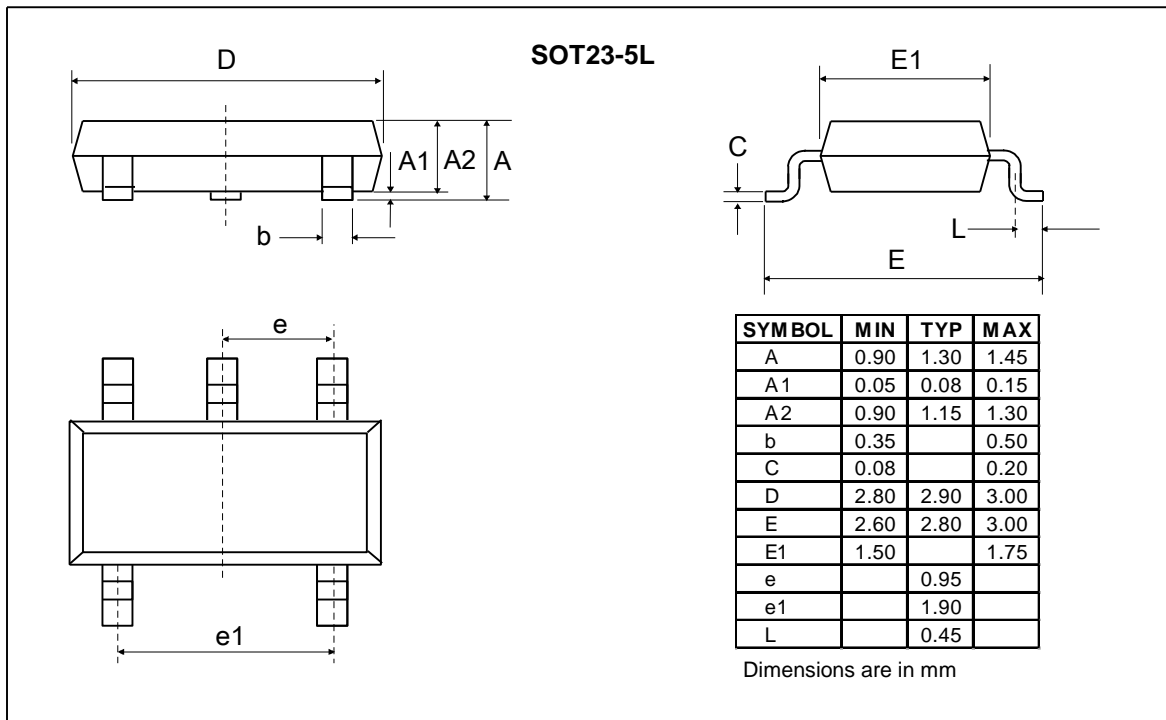
 **$I_{DD}$  vs. Temperature**

**Propagation Time  $t_P$  vs. Temperature**

**Reset Timeout Period  $t_{POR}$  vs. Temperature (normalized with respect to  $t_{POR}$   $25^\circ\text{C}$ )**

**Maximum Transient Duration  $t_{SEN}$  vs. Overdrive  $V_{TH}-V_{DD}$** 

**Threshold Voltage Variation vs. Temperature (normalized)**

**Package Information**



## Traceability for small packages

Due to the limited space on the package surface, the bottom marking contains a limited number of characters that provide only partial information for lot traceability. Full information for complete traceability is however provided on the packing labels of the product at delivery from EM. It is highly recommended that the customer insures full lot traceability of EM product in his final product.

EM Microelectronic-Marín SA ("EM") makes no warranties for the use of EM products, other than those expressly contained in EM's applicable General Terms of Sale, located at <http://www.emmicroelectronic.com>. EM assumes no responsibility for any errors which may have crept into this document, reserves the right to change devices or specifications detailed herein at any time without notice, and does not make any commitment to update the information contained herein.

No licenses to patents or other intellectual property rights of EM are granted in connection with the sale of EM products, neither expressly nor implicitly.

In respect of the intended use of EM products by customer, customer is solely responsible for observing existing patents and other intellectual property rights of third parties and for obtaining, as the case may be, the necessary licenses.

**Important note: The use of EM products as components in medical devices and/or medical applications, including but not limited to, safety and life supporting systems, where malfunction of such EM products might result in damage to and/or injury or death of persons is expressly prohibited, as EM products are neither destined nor qualified for use as components in such medical devices and/or medical applications. The prohibited use of EM products in such medical devices and/or medical applications is exclusively at the risk of the customer**

Product qualification is performed according to internal EM quality standards for industrial products. For any special requirement (eg. automotive grade) please contact EM Microelectronic-Marín S.A.

## Looking for pricing, stock, or lifecycle information?

Click below to explore more details on WIN SOURCE:

- ⊖ [View EM6325CXSP5B-2.9+ on WIN SOURCE](#)
- ⊖ [EM Microelectronic Information](#)

## Optimize Your Supply Chain with WIN SOURCE Solutions

- ✓ Global Sourcing Solution
- ✓ Obsolete Management
- ✓ Cost Control Management
- ✓ Shortage Management
- ✓ Alternative Solution
- ✓ Excess Inventory Management