



## GaAs MMIC SMT HIGH ISOLATION SPDT SWITCH, DC - 6 GHz

### Typical Applications

The HMC232G7 is ideal for:

- Telecom Infrastructure
- Microwave Radio & VSAT
- Military Radios, Radar & ECM
- Space Systems
- Test Instrumentation

### Features

- Isolation: 55 dB @ 2 GHz  
42 dB @ 6 GHz
- Insertion Loss: 1.9 dB Typical @ 6 GHz
- Non-Reflective Design
- Hermetic Surface Mount Package
- Direct Replacement for HMC132G7

### Functional Diagram

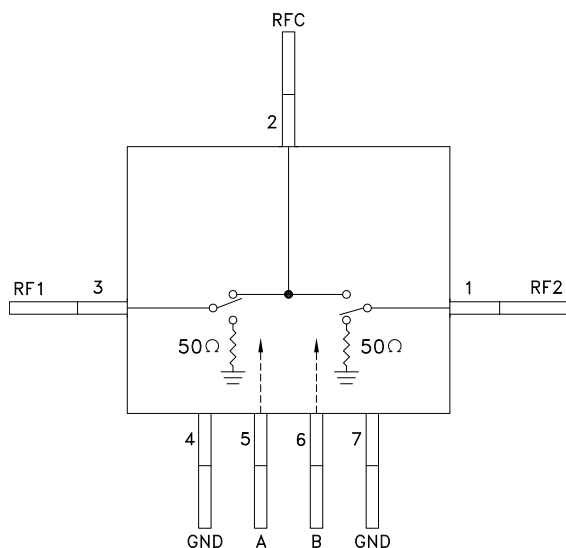

### General Description

The HMC232G7 is a broadband high isolation non-reflective GaAs MESFET SPDT switch in a hermetic surface mount package. Covering DC to 6 GHz, the switch features >55 dB isolation up to 2 GHz and >42 dB isolation up to 6 GHz. The switch operates using complementary negative control voltage logic lines of -5/0V and requires no bias supply. This product is a form, fit & functional replacement for the HMC132G7.

### Electrical Specifications, $T_A = +25^\circ C$ , With 0/-5V Control, 50 Ohm System

Parameter	Frequency	Min.	Typ.	Max.	Units
Insertion Loss	DC - 2.0 GHz		1.3	1.6	dB
	DC - 4.0 GHz		1.4	1.7	dB
	DC - 6.0 GHz		1.9	2.3	dB
Isolation	DC - 2.0 GHz	50	55		dB
	DC - 4.0 GHz	41	46		dB
	DC - 6.0 GHz	37	42		dB
Return Loss	DC - 2.0 GHz		18		dB
	DC - 4.0 GHz		17		dB
	DC - 6.0 GHz		12		dB
Return Loss RF1, RF2	DC - 2.0 GHz		14		dB
	DC - 4.0 GHz		13		dB
	DC - 6.0 GHz		11		dB
Input Power for 1 dB Compression	0.5 - 6.0 GHz	23	27		dBm
Input Third Order Intercept (Two-Tone Input Power= +7 dBm Each Tone, 1 MHz Tone Separation)	0.5 - 6.0 GHz		49		dBm
Switching Characteristics	DC - 6.0 GHz		3		ns
		tRISE, tFALL (10/90% RF) tON, tOFF (50% CTL to 10/90% RF)		6	

Information furnished by Analog Devices is believed to be accurate and reliable. However, no responsibility is assumed by Analog Devices for its use, nor for any infringements of patents or other rights of third parties that may result from its use. Specifications subject to change without notice. No license is granted by implication or otherwise under any patent or patent rights of Analog Devices. Trademarks and registered trademarks are the property of their respective owners.

For price, delivery, and to place orders: Analog Devices, Inc., One Technology Way, P.O. Box 9106, Norwood, MA 02062-9106  
Phone: 781-329-4700 • Order online at [www.analog.com](http://www.analog.com)  
Application Support: Phone: 1-800-ANALOG-D

## GaAs MMIC SMT HIGH ISOLATION SPDT SWITCH, DC - 6 GHz

**Insertion Loss**

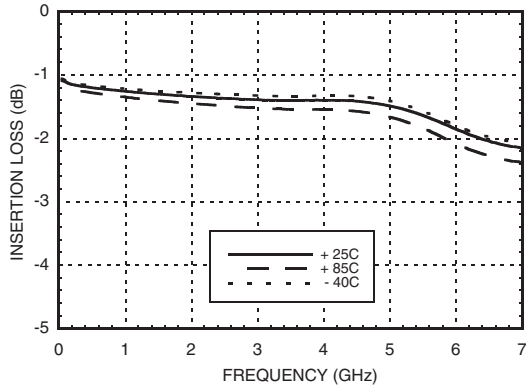

**Isolation**

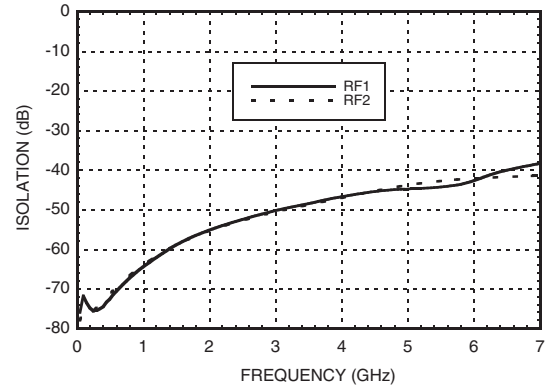

**Return Loss**

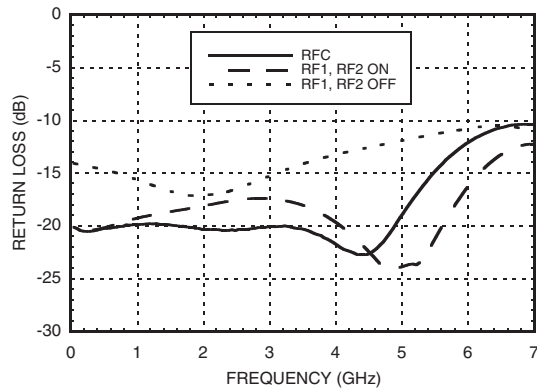

**0.1 and 1 dB Input Compression Point**

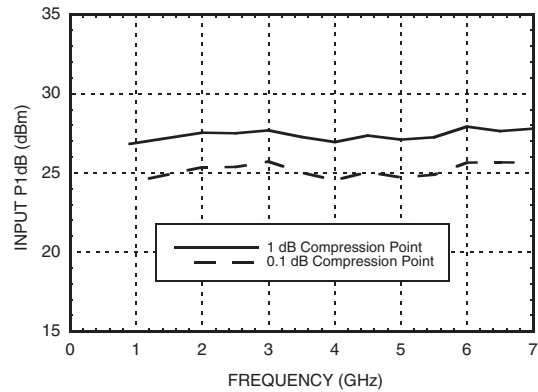

**Input Third Order Intercept Point**

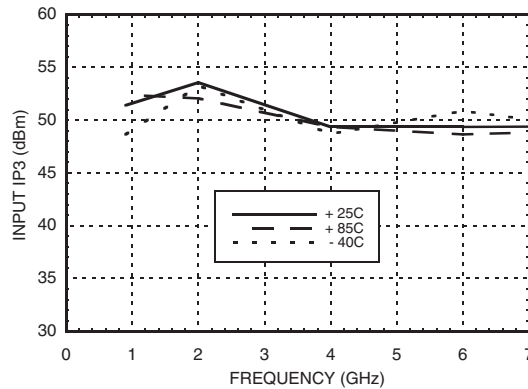

Information furnished by Analog Devices is believed to be accurate and reliable. However, no responsibility is assumed by Analog Devices for its use, nor for any infringements of patents or other rights of third parties that may result from its use. Specifications subject to change without notice. No license is granted by implication or otherwise under any patent or patent rights of Analog Devices. Trademarks and registered trademarks are the property of their respective owners.

For price, delivery, and to place orders: Analog Devices, Inc., One Technology Way, P.O. Box 9106, Norwood, MA 02062-9106 Phone: 781-329-4700 • Order online at [www.analog.com](http://www.analog.com) Application Support: Phone: 1-800-ANALOG-D

## GaAs MMIC SMT HIGH ISOLATION SPDT SWITCH, DC - 6 GHz

### Absolute Maximum Ratings

RF Input Power ( $V_A, V_B = 0/-5V$ ) (0.5 - 6 GHz)	+30 dBm (@ +50 °C)
Control Voltage Range (A & B)	+1.0V to -7.5 Vdc
Channel Temperature	150 °C
Thermal Resistance ( $R_{TH}$ ) (junction to lead)	94 °C/W
Storage Temperature	-65 to +150 °C
Operating Temperature	-40 to +85 °C
ESD Sensitivity (HBM)	Class 1A

### Control Voltages

State	Bias Condition
Low	0 to -0.2V @ 10 uA Max.
High	-5V @ 10 uA Typ. to -7V @ 45 uA Typ.

### Truth Table

Control Input		Signal Path State	
A	B	RFC to RF1	RFC to RF2
High	Low	ON	OFF
Low	High	OFF	ON



**ELECTROSTATIC SENSITIVE DEVICE  
OBSERVE HANDLING PRECAUTIONS**

Caution: Do not "Hot Switch" power levels greater than +27 dBm ( $V_A, V_B = 0/-5V$ ).

### Outline Drawing

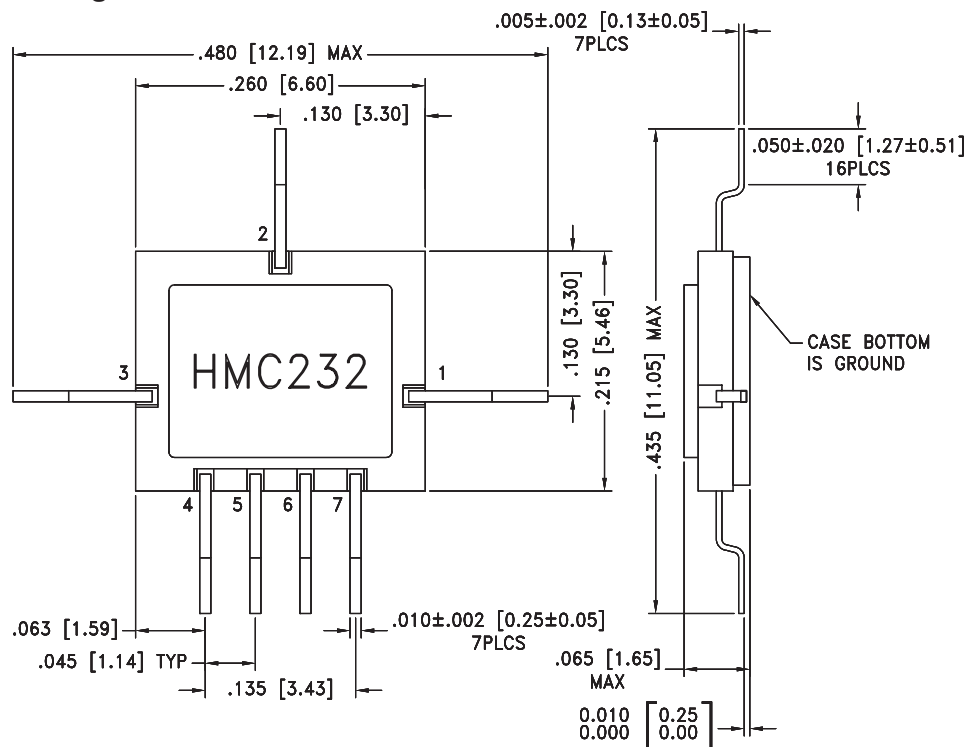

#### NOTES:

1. PACKAGE BODY MATERIAL: WHITE ALUMINA 92%
2. CONDUCTOR TRACES MATERIAL: THICK FILM TUNGSTEN.
3. LEAD, BASE, COVER MATERIAL: KOVAR™.
4. PLATING: ELECTROLYTIC GOLD 50 MICROINCHES MIN, OVER ELECTROLYTIC NICKEL 50 MICROINCHES MIN.
5. ALL DIMENSIONS ARE IN INCHES [MILLIMETERS].
6. TOLERANCES: ±.005 [0.13] UNLESS OTHERWISE SPECIFIED.
7. ALL GROUND LEADS AND GROUND PADDLE MUST BE SOLDERED TO PCB RF GROUND.

## GaAs MMIC SMT HIGH ISOLATION SPDT SWITCH, DC - 6 GHz

### Suggested Driver Circuit

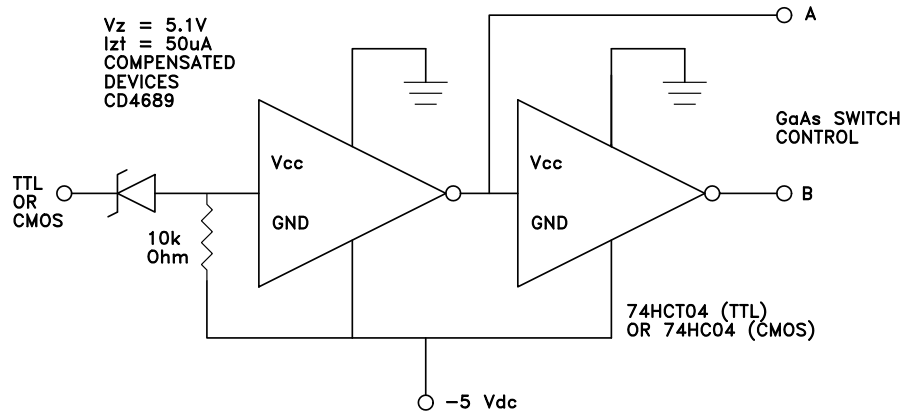

### Pin Descriptions

Pin Number	Function	Description	Interface Schematic
1, 2, 3	RF2, RFC, RF1	This pin is DC coupled and matched to 50 Ohm. Blocking capacitors are required if RF line potential is not equal to 0V.	
4, 7	GND	Package bottom must also be connected to PCB RF ground.	
5	A	See truth table and control voltage table.	
6	B	See truth table and control voltage table.	

## GaAs MMIC SMT HIGH ISOLATION SPDT SWITCH, DC - 6 GHz

### Evaluation PCB

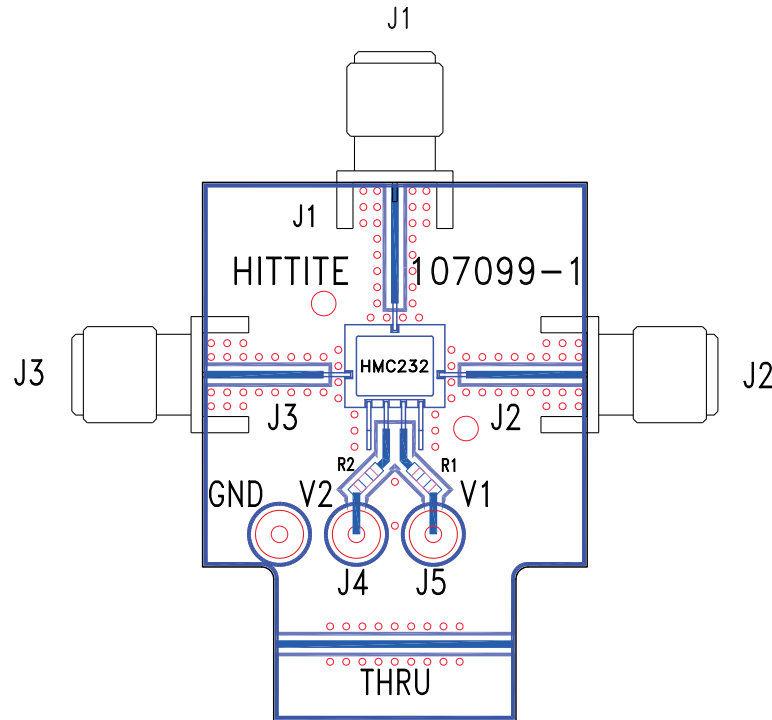

10

SWITCHES - SMT

### List of Materials for Evaluation PBC 107181 [1]

Item	Description
J1 - J3	PCB Mount SMA RF Connector
J4 - J6	DC Pin
R1, R2	100 Ohm Resistor, 0603 Pkg.
U1	HMC232G7 SPDT Switch
PCB [2]	107099 Evaluation PCB

[1] Reference this number when ordering complete evaluation PCB

[2] Circuit Board Material: Rogers 4350

The circuit board used in the final application should be generated with proper RF circuit design techniques. Signal lines at the RF port should have 50 ohm impedance and the package ground leads and package bottom should be connected directly to the ground plane similar to that shown above. The evaluation circuit board shown above is available from Hittite Microwave Corporation upon request.



# HMC232G7

v02.1006

## GaAs MMIC SMT HIGH ISOLATION SPDT SWITCH, DC - 6 GHz

### Notes:

10



SWITCHES - SMT

Information furnished by Analog Devices is believed to be accurate and reliable. However, no responsibility is assumed by Analog Devices for its use, nor for any infringements of patents or other rights of third parties that may result from its use. Specifications subject to change without notice. No license is granted by implication or otherwise under any patent or patent rights of Analog Devices. Trademarks and registered trademarks are the property of their respective owners.

For price, delivery, and to place orders: Analog Devices, Inc., One Technology Way, P.O. Box 9106, Norwood, MA 02062-9106  
Phone: 781-329-4700 • Order online at [www.analog.com](http://www.analog.com)  
Application Support: Phone: 1-800-ANALOG-D

## Looking for pricing, stock, or lifecycle information?

Click below to explore more details on WIN SOURCE:

-  [View HMC232G7 on WIN SOURCE](#)
-  [Analog Devices Inc. Information](#)

## Optimize Your Supply Chain with WIN SOURCE Solutions

-  Global Sourcing Solution
-  Obsolete Management
-  Cost Control Management
-  Shortage Management
-  Alternative Solution
-  Excess Inventory Management