



Film Capacitors

Metallized Polypropylene Film Capacitors (MKP)

Series/Type: B32671Z ... B32676Z

Date: June 2018

© EPCOS AG 2018. Reproduction, publication and dissemination of this publication, enclosures hereto and the information contained therein without EPCOS' prior express consent is prohibited.

EPCOS AG is a TDK Group Company.

Power Factor Correction
Typical applications

- PFC (Power Factor Correction)
- Not suitable for "across the line" applications

Climatic

- Max. operating temperature: 125 °C
- Climatic category (IEC 60068-1:2013): 55/110/56

Construction

- Dielectric: metallized polypropylene (PP)
- Wound capacitor technology
- Plastic case (UL 94 V-0)
- Epoxy resin sealing, flame retardant

Features

- High frequency capability
- Very small dimensions
- RoHS-compatible
- Halogen-free capacitors available on request
- AEC-Q200D compliant

Terminals

- Parallel wire leads, lead-free tinned

Marking

- Manufacturer's logo
- Rated capacitance (coded)
- Capacitance tolerance
- Rated DC voltage
- Type number

Delivery mode

- Bulk (untaped)
- Taped (Ammo pack or reel)

For notes on taping, refer to chapter "Taping and packing".

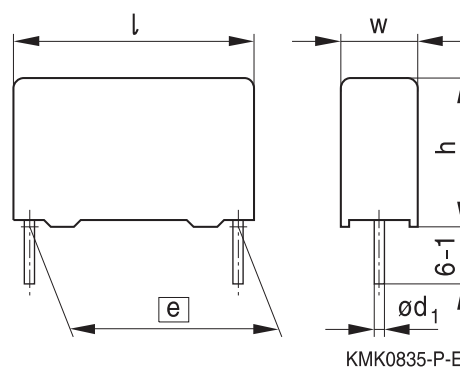
Dimensional drawing

Dimensions in mm

Lead spacing	Lead diameter	Type
$e \pm 0.4$	$d_1 \pm 0.05$	
10	0.6	B32671Z
15	0.8	B32672Z
22.5	0.8	B32673Z
27.5	0.8	B32674Z
37.5	1.0	B32676Z



Overview of available types

Lead spacing	10 mm	15 mm			22.5 mm		
Type	B32671Z	B32672Z			B32673Z		
Page	5	6			7		
V_{RMS} (V AC)	310	220	277	310	220	277	310
V_R (V DC)	630	450	520	630	450	520	630
C_R (μ F)							
0.010							
0.015							
0.022							
0.033							
0.047							
0.068							
0.10							
0.12							
0.15							
0.22							
0.33							
0.47							
0.56							
0.68							
1.0							
1.2							
1.5							
2.2							

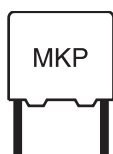

B32671Z ... B32676Z

Power Factor Correction

Overview of available types

Lead spacing	27.5 mm			37.5 mm		
Type	B32674Z			B32676Z		
Page	8			9		
V_{RMS} (V AC)	220	277	310	220	277	310
V_R (V DC)	450	520	630	450	520	630
C_R (μ F)						
1.0						
1.5						
1.8						
2.2						
2.7						
3.3						
3.9						
4.7						
5.6						
6.8						
8.2						
10						
12						
15						
18						
22						

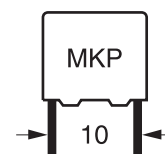
Ordering codes and packing units (lead spacing 10 mm)

V_{RMS} $f \leq 1$ kHz V AC	V_R V DC	C_R μF	Max. dimensions $w \times h \times l$ mm	Ordering code (composition see below)	Ammo pack pcs./MOQ	Reel pcs./MOQ	Untaped pcs./MOQ
310	630	0.010	4.0 × 9.0 × 13.0	B32671Z6103+***	4000	6800	4000
		0.015	4.0 × 9.0 × 13.0	B32671Z6153+***	4000	6800	4000
		0.022	4.0 × 9.0 × 13.0	B32671Z6223+***	4000	6800	4000
		0.033	5.0 × 11.0 × 13.0	B32671Z6333+***	3320	5200	4000
		0.047	5.0 × 11.0 × 13.0	B32671Z6473+***	3320	5200	4000
		0.068	6.0 × 12.0 × 13.0	B32671Z6683+***	2720	4400	4000
		0.10	6.0 × 12.0 × 13.0	B32671Z6104+***	2720	4400	4000

MOQ = Minimum Order Quantity, consisting of 4 packing units.

Further E series, intermediate capacitance values and closer tolerance on request.

Composition of ordering code

+ = Capacitance tolerance code:

K = $\pm 10\%$

J = $\pm 5\%$

*** = Packaging code:

000 = Straight terminals, untaped (standard lead length 6 – 1 mm)

003 = Straight terminals, untaped (lead length 3.2 \pm 0.3 mm)

289 = Straight terminals, Ammo pack

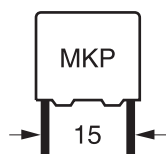
B32672Z
Power Factor Correction
Ordering codes and packing units (lead spacing 15 mm)

V_{RMS} $f \leq 1$ kHz V AC	V_R V DC	C_R μF	Max. dimensions $w \times h \times l$ mm	Ordering code (composition see below)	Ammo pack pcs./MOQ	Reel pcs./MOQ	Untaped pcs./MOQ
220	450	0.10	5.0 × 10.5 × 18.0	B32672Z4104+***	4680	5200	4000
		0.15	5.0 × 10.5 × 18.0	B32672Z4154+***	4680	5200	4000
		0.22	6.0 × 11.0 × 18.0	B32672Z4224+***	3840	4400	4000
		0.33	7.0 × 12.5 × 18.0	B32672Z4334+***	3320	3600	4000
		0.47	8.0 × 14.0 × 18.0	B32672Z4474+***	2920	3000	2000
		0.68	9.0 × 17.5 × 18.0	B32672Z4684+***	2560	2800	2000
		1.0	11.0 × 18.5 × 18.0	B32672Z4105+***	–	2200	1200
277	520	0.047	5.0 × 10.5 × 18.0	B32672Z5473+***	4680	5200	4000
		0.10	6.0 × 11.0 × 18.0	B32672Z5104+***	3840	4400	4000
		0.15	6.0 × 11.0 × 18.0	B32672Z5154+***	3840	4400	4000
		0.22	7.0 × 12.5 × 18.0	B32672Z5224+***	3320	3600	4000
		0.33	8.5 × 14.5 × 18.0	B32672Z5334+***	2720	2800	2000
		0.47	9.0 × 17.5 × 18.0	B32672Z5474+***	2560	2800	2000
		0.68	11.0 × 18.5 × 18.0	B32672Z5684+***	–	2000	1200
		1.0	11.0 × 18.5 × 18.0	B32672Z5105K***	–	2200	1200
310	630	0.033	5.0 × 10.5 × 18.0	B32672Z6333+***	4680	5200	4000
		0.047	5.0 × 10.5 × 18.0	B32672Z6473+***	4680	5200	4000
		0.068	5.0 × 10.5 × 18.0	B32672Z6683+***	4680	5200	4000
		0.10	6.0 × 11.0 × 18.0	B32672Z6104+***	3840	4400	4000
		0.12	6.0 × 11.0 × 18.0	B32672Z6124+***	3840	4400	4000
		0.15	6.0 × 12.0 × 18.0	B32672Z6154+***	3840	4400	4000
		0.33	8.5 × 14.5 × 18.0	B32672Y6334K***	2720	2800	2000
		0.33	9.0 × 17.5 × 18.0	B32672Z6334+***	2560	2800	2000
		0.47	11.0 × 18.5 × 18.0	B32672Z6474+***	–	2000	1200
		0.56	11.0 × 18.5 × 18.0	B32672Z6564+***	–	2200	1200

MOQ = Minimum Order Quantity, consisting of 4 packing units.

Further E series, intermediate capacitance values and closer tolerance on request.

Composition of ordering code

+ = Capacitance tolerance code:

K = ±10%

J = ±5%

*** = Packaging code:

000 = Straight terminals, untaped (standard lead length 6 – 1 mm)

003 = Straight terminals, untaped (lead length 3.2 ± 0.3 mm)

289 = Straight terminals, Ammo pack

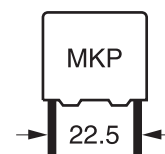
Ordering codes and packing units (lead spacing 22.5 mm)

V_{RMS} $f \leq 1$ kHz V AC	V_R V DC	C_R μF	Max. dimensions $w \times h \times l$ mm	Ordering code (composition see below)	Ammo pack pcs./MOQ	Reel pcs./MOQ	Untaped pcs./MOQ
220	450	0.22	6.0 × 15.0 × 26.5	B32673Z4224+***	2720	2800	2880
		0.22	7.5 × 14.0 × 26.5	B32673T4224K***	2200	2000	2280
		0.33	6.0 × 15.0 × 26.5	B32673Z4334+***	2720	2800	2880
		0.33	7.5 × 14.0 × 26.5	B32673T4334K***	2200	2000	2280
		0.47	6.0 × 15.0 × 26.5	B32673Z4474+***	2720	2800	2880
		0.47	7.5 × 14.0 × 26.5	B32673T4474K***	2200	2000	2280
		0.68	7.0 × 16.0 × 26.5	B32673Z4684+***	2320	2400	2520
		0.68	7.5 × 14.0 × 26.5	B32673T4684+***	2200	2000	2280
		1.0	10.5 × 16.5 × 26.5	B32673Z4105+***	1560	1600	2160
		1.5	11.0 × 20.5 × 26.5	B32673Z4155+***	1480	1400	2040
		2.2	12.0 × 22.5 × 26.5	B32673Z4225+***	—	—	1800
277	520	0.22	6.0 × 15.0 × 26.5	B32673Z5224+***	2720	2800	2880
		0.22	7.5 × 14.0 × 26.5	B32673T5224K***	2200	2000	2280
		0.33	6.0 × 15.0 × 26.5	B32673Z5334+***	2720	2800	2880
		0.33	7.5 × 14.0 × 26.5	B32673T5334K***	2200	2000	2280
		0.47	7.0 × 16.0 × 26.5	B32673Z5474+***	2320	2400	2520
		0.47	7.5 × 14.0 × 26.5	B32673T5474K***	2200	2000	2280
		0.68	10.5 × 16.5 × 26.5	B32673Z5684+***	1560	1600	2160
		1.0	10.5 × 16.5 × 26.5	B32673Z5105+***	—	—	2160
		1.5	12.0 × 22.5 × 26.5	B32673Z5155+***	—	—	1800
310	630	0.15	6.0 × 15.0 × 26.5	B32673Z6154+***	2720	2800	2880
		0.22	6.0 × 15.0 × 26.5	B32673Z6224+***	2720	2800	2880
		0.33	7.0 × 16.0 × 26.5	B32673Z6334+***	2820	2400	2520
		0.33	7.5 × 14.0 × 26.5	B32673T6334+***	2200	2000	2280
		0.47	8.5 × 16.5 × 26.5	B32673Z6474+***	1920	2000	2040
		0.68	10.5 × 18.5 × 26.5	B32673Z6684+***	1560	1600	2160
		1.0	11.0 × 20.5 × 26.5	B32673Z6105+***	1480	1400	2040
		1.2	12.0 × 22.0 × 26.5	B32673Z6125+***	—	—	1800
		1.5	14.0 × 29.5 × 26.5	B32673Z6155+***	—	—	2160
		2.2	14.0 × 29.5 × 26.5	B32673Z6225+***	—	—	2160

MOQ = Minimum Order Quantity, consisting of 4 packing units.

Further E series, intermediate capacitance values and closer tolerance on request.

Composition of ordering code

+ = Capacitance tolerance code:

K = ±10%

J = ±5%

*** = Packaging code:

000 = Straight terminals, untaped (standard lead length 6 – 1 mm)

003 = Straight terminals, untaped (lead length 3.2 ±0.3 mm)

289 = Straight terminals, Ammo pack

B32674Z
Power Factor Correction
Ordering codes and packing units (lead spacing 27.5 mm)

V_{RMS} $f \leq 1$ kHz V AC	V_R V DC	C_R μF	Max. dimensions $w \times h \times l$ mm	Ordering code (composition see below)	Ammo pack pcs./MOQ	Reel pcs./MOQ	Untaped pcs./MOQ		
220	450	1.5	11.0 × 19.0 × 31.5	B32674Z4155+***	—	1400	1280		
		1.8	11.0 × 21.0 × 31.5	B32674Z4185+***	—	2800	1280		
		2.2	11.0 × 21.0 × 31.5	B32674Z4225+***	—	2800	1280		
		2.7	13.5 × 23.0 × 31.5	B32674Z4275+***	—	1000	1040		
		3.3	14.0 × 24.5 × 31.5	B32674Z4335+***	—	1000	1040		
		3.9	16.0 × 32.0 × 31.5	B32674Z4395+***	—	—	880		
		4.7	16.0 × 32.0 × 31.5	B32674Z4475+***	—	—	880		
		5.6	18.0 × 33.0 × 31.5	B32674Z4565K***	—	—	880		
		6.8	21.0 × 31.0 × 31.5	B32674Z4685+***	—	—	720		
		8.2	22.0 × 36.5 × 31.5	B32674Z4825+***	—	—	640		
277	520	1.0	11.0 × 19.0 × 31.5	B32674Z5105+***	—	1400	1280		
		1.5	12.5 × 21.5 × 31.5	B32674Z5155+***	—	1200	1120		
		1.8	13.5 × 23.0 × 31.5	B32674Z5185+***	—	1000	1040		
		2.2	15.0 × 24.5 × 31.5	B32674Z5225+***	—	—	960		
		2.7	18.0 × 27.5 × 31.5	B32674Z5275+***	—	—	800		
		3.3	16.0 × 32.0 × 31.5	B32674Z5335K***	—	—	880		
		3.9	18.0 × 33.0 × 31.5	B32674Z5395+***	—	—	800		
		4.7	21.0 × 31.0 × 31.5	B32674Z5475+***	—	—	720		
				5.6	22.0 × 36.5 × 31.5	B32674Z5565+***	—	—	640
310	630	1.0	11.0 × 19.0 × 31.5	B32674Z6105+***	—	1400	1280		
		1.5	13.5 × 23.0 × 31.5	B32674Z6155+***	—	1000	1040		
		1.8	14.0 × 24.5 × 31.5	B32674Z6185+***	—	1000	1040		
		2.2	16.0 × 32.0 × 31.5	B32674Z6225+***	—	—	880		
		2.7	16.0 × 32.0 × 31.5	B32674Z6275K***	—	—	880		
		3.3	18.0 × 33.0 × 31.5	B32674Z6335+***	—	—	800		
		3.9	21.0 × 31.0 × 31.5	B32674Z6395+***	—	—	720		
				4.7	22.0 × 36.5 × 31.5	B32674Z6475+***	—	—	640

MOQ = Minimum Order Quantity, consisting of 4 packing units.

Further E series, intermediate capacitance values and closer tolerance on request.

Composition of ordering code

+ = Capacitance tolerance code:

K = $\pm 10\%$

J = $\pm 5\%$

*** = Packaging code:

000 = Straight terminals, untaped (standard lead length 6 – 1 mm)

003 = Straight terminals, untaped (lead length 3.2 ± 0.3 mm)

289 = Straight terminals, Ammo pack

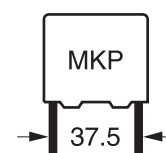
Ordering codes and packing units (lead spacing 37.5 mm)

V_{RMS} $f \leq 1$ kHz V AC	V_R V DC	C_R μF	Max. dimensions $w \times h \times l$ mm	Ordering code (composition see below)	Ammo pack pcs./MOQ	Reel pcs./MOQ	Untaped pcs./MOQ
220	450	2.2	12.0 × 22.0 × 42.0	B32676Z4225+***	—	—	1620
		2.7	12.0 × 22.0 × 42.0	B32676Z4275+***	—	—	1620
		3.3	14.0 × 25.0 × 42.0	B32676Z4335+***	—	—	1380
		3.9	14.0 × 25.0 × 42.0	B32676Z4395+***	—	—	1380
		4.7	16.0 × 28.5 × 42.0	B32676Z4475+***	—	—	800
		5.6	16.0 × 28.5 × 42.0	B32676Z4565+***	—	—	800
		6.8	18.0 × 32.5 × 42.0	B32676Z4685+***	—	—	720
		8.2	20.0 × 39.5 × 42.0	B32676Z4825+***	—	—	640
		10.0	20.0 × 39.5 × 42.0	B32676Z4106+***	—	—	640
		12.0	20.0 × 39.5 × 42.0	B32676Z4126+***	—	—	640
		15.0	28.0 × 42.5 × 42.0	B32676Z4156+***	—	—	440
		18.0	30.0 × 45.0 × 42.0	B32676Z4186+***	—	—	400
		22.0	33.0 × 48.0 × 42.0	B32676Z4226+***	—	—	180
277	520	2.2	12.0 × 22.0 × 42.0	B32676Z5225+***	—	—	1620
		2.7	14.0 × 25.0 × 42.0	B32676Z5275+***	—	—	1380
		3.3	14.0 × 25.0 × 42.0	B32676Z5335+***	—	—	1380
		3.9	16.0 × 28.5 × 42.0	B32676Z5395+***	—	—	800
		4.7	18.0 × 32.5 × 42.0	B32676Z5475+***	—	—	720
		5.6	18.0 × 32.5 × 42.0	B32676Z5565+***	—	—	720
		6.8	20.0 × 39.5 × 42.0	B32676Z5685+***	—	—	640
		8.2	20.0 × 39.5 × 42.0	B32676Z5825K***	—	—	640
		10.0	28.0 × 37.0 × 42.0	B32676Z5106+***	—	—	440
		12.0	28.0 × 42.5 × 42.0	B32676Z5126K***	—	—	440
		15.0	33.0 × 48.0 × 42.0	B32676Z5156+***	—	—	180

MOQ = Minimum Order Quantity, consisting of 4 packing units.

Further E series, intermediate capacitance values and closer tolerance on request.

Composition of ordering code

+ = Capacitance tolerance code:

K = $\pm 10\%$

J = $\pm 5\%$

*** = Packaging code:

000 = Straight terminals, untaped (standard lead length 6 – 1 mm)

003 = Straight terminals, untaped (lead length 3.2 ± 0.3 mm)

289 = Straight terminals, Ammo pack

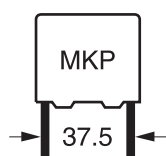
B32676Z
Power Factor Correction
Ordering codes and packing units (lead spacing 37.5 mm)

V_{RMS} $f \leq 1$ kHz V AC	V_R V DC	C_R μF	Max. dimensions $w \times h \times l$ mm	Ordering code (composition see below)	Ammo pack pcs./MOQ	Reel pcs./MOQ	Untaped pcs./MOQ
310	630	1.8	14.0 × 25.0 × 42.0	B32676Z6185+***	—	—	1380
		2.2	14.0 × 25.0 × 42.0	B32676Z6225+***	—	—	1380
		2.7	14.0 × 25.0 × 42.0	B32676Z6275+***	—	—	1380
		3.3	16.0 × 28.5 × 42.0	B32676Z6335+***	—	—	800
		3.9	18.0 × 32.5 × 42.0	B32676Z6395+***	—	—	720
		4.7	18.0 × 32.5 × 42.0	B32676Z6475+***	—	—	720
		5.6	20.0 × 39.5 × 42.0	B32676Z6565+***	—	—	640
		6.8	20.0 × 39.5 × 42.0	B32676Z6685+***	—	—	640
		8.2	28.0 × 37.0 × 42.0	B32676Z6825+***	—	—	440
		10.0	28.0 × 42.5 × 42.0	B32676Z6106+***	—	—	440
		12.0	30.0 × 45.0 × 42.0	B32676Z6126+***	—	—	400
15.0	33.0 × 48.0 × 42.0	B32676Z6156+***	—	—	180		

MOQ = Minimum Order Quantity, consisting of 4 packing units.

Further E series, intermediate capacitance values and closer tolerance on request.

Composition of ordering code

+ = Capacitance tolerance code:

K = $\pm 10\%$

J = $\pm 5\%$

*** = Packaging code:

000 = Straight terminals, untaped (standard lead length 6 – 1 mm)

003 = Straight terminals, untaped (lead length 3.2 ± 0.3 mm)

289 = Straight terminals, Ammo pack

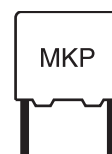

Technical data

Reference standard: IEC 60384-16:2005 and AEC-Q200D. All data given at $T = 20\text{ °C}$, unless otherwise specified.

Operating temperature range	Max. operating temperature $T_{op, max}$	+125 °C	
	Upper category temperature T_{max}	+110 °C	
	Lower category temperature T_{min}	-55 °C	
	Rated temperature T_R	+85 °C	
Dissipation factor $\tan \delta$ (in 10^{-3}) at 20 °C (upper limit values)		$C_R \leq 0.1\ \mu\text{F}$	$C_R > 0.1\ \mu\text{F}$
	at 1 kHz 100 kHz	≤ 1 (typically 0.6) 5.0	1.0 -
Insulation resistance R_{ins} or time constant $\tau = C_R \cdot R_{ins}$ at 20 °C, rel. humidity $\leq 65\%$ (minimum as-delivered values)	$> 30\ 000\ \text{M}\Omega$ ($C_R \leq 0.33\ \mu\text{F}$)		
	$> 10\ 000\ \text{s}$ ($C_R > 0.33\ \mu\text{F}$)		
DC test voltage	$1.6 \times V_R, 2\ \text{s}$		
Category voltage V_C continuous operation with V_{DC} or V_{AC} at $f \leq 1\ \text{kHz}$	T_{op} (°C)	DC voltage derating	AC voltage derating
	$T_{op} \leq 85$	$V_C = V_R$	$V_{RMS} = V_{RMS}$
	$85 < T_{op} \leq 110$	$V_C = V_R \cdot (165 - T_{op})/80$	$V_{RMS} = V_{RMS} \cdot (165 - T_{op})/80$
short time operation with V_{DC} or V_{AC} at $f \leq 1\ \text{kHz}$	$110 < T_{op} \leq 125$	$V_C = V_R \cdot (165 - T_{op})/80$	$V_{RMS} = V_{RMS} \cdot (165 - T_{op})/80$
Operating voltage V_{op} for short operating periods (V_{DC} or V_{AC} at $f \leq 1\ \text{kHz}$)	T_{op} (°C)	DC voltage (max. hours)	AC voltage (max. hours)
	$T_{op} \leq 100$	$V_{op} = 1.25 \cdot V_C$ (2000 h)	$V_{op} = 1.0 \cdot V_{C,RMS}$ (2000 h)
	$100 < T_{op} \leq 125$	$V_{op} = 1.25 \cdot V_C$ (1000 h)	$V_{op} = 1.0 \cdot V_{C,RMS}$ (1000 h)
Passive flammability category in accordance to IEC 40(CO)752	C		
Biased humidity Limit values after test	1000 hours / 40°C / 93% relative humidity with $V_{R,DC}$		
	Capacitance change $ \Delta C/C $	$\leq 5\%$	
	Dissipation factor change $\Delta \tan \delta$	$\leq 2.0 \cdot 10^{-3}$ (at 1 kHz)	
	Insulation resistance R_{ins}	$\geq 200\ \text{M}\Omega$	
Reliability: Failure rate λ Service life t_{SL}	1 fit ($\leq 1 \cdot 10^{-9}/\text{h}$) at $0.5 \cdot V_R, 40\text{ °C}$ 20000 h at $1.0 \cdot V_R, 85\text{ °C}$ For conversion to other operating conditions and temperatures, refer to chapter "Quality, 2 Reliability".		
	Failure criteria: Total failure Failure due to variation of parameters	Short circuit or open circuit Capacitance change $ \Delta C/C $ Dissipation factor $\tan \delta$ Insulation resistance R_{ins} or time constant τ	$> 10\%$ $> 4 \cdot$ upper limit values $< 1500\ \text{M}\Omega$ ($C_R \leq 0.33\ \mu\text{F}$) $< 50\ \text{s}$ ($C_R \geq 0.33\ \mu\text{F}$)

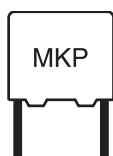

B32671Z ... B32676Z

Power Factor Correction

Pulse handling capability

"dV/dt" represents the maximum permissible voltage change per unit of time for non-sinusoidal voltages, expressed in V/μs.

"k₀" represents the maximum permissible pulse characteristic of the waveform applied to the capacitor, expressed in V²/μs.

Note:

The values of dV/dt and k₀ provided below must not be exceeded in order to avoid damaging the capacitor. These parameters are given for isolated pulses in such a way that the heat generated by one pulse will be completely dissipated before applying the next pulse. For a train of pulses, please refer to the curves of permissible AC voltage-current versus frequency.

dV/dt values

Lead spacing		10 mm	15 mm	22.5 mm	27.5 mm	37.5 mm
V _R V DC	V _{RMS} V AC	dV/dt in V/μs				
450	220	–	160	100	75	54
520	277	–	200	120	85	60
630	310	400	250	160	100	73

k₀ values

Lead spacing		10 mm	15 mm	22.5 mm	27.5 mm	37.5 mm
V _R V DC	V _{RMS} V AC	k ₀ in V ² /μs				
450	220	–	128 000	80 000	67 000	48 000
520	277	–	208 000	125 000	88 000	62 000
630	310	504 000	504 000	202 000	126 000	92 000

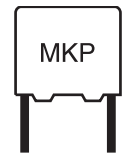

Impedance Z versus frequency f
 (typical values)

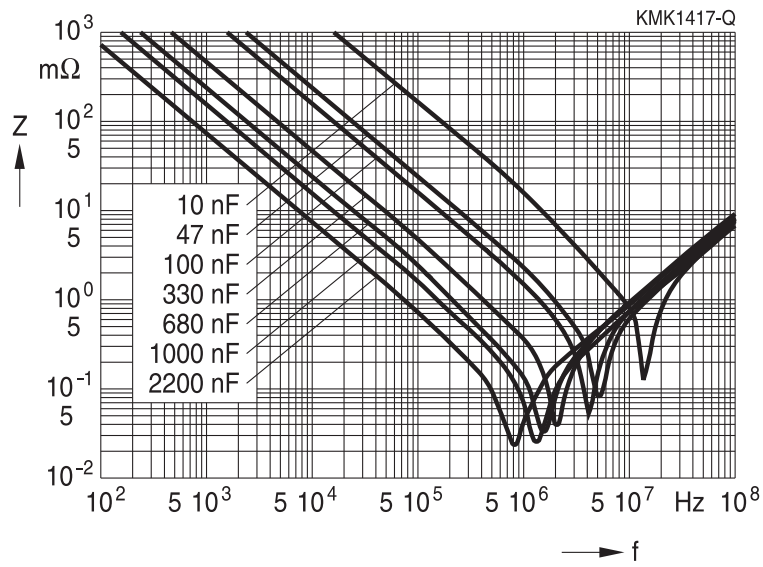

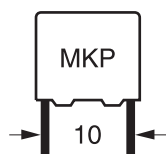

B32671Z

Power Factor Correction

Permissible AC voltage V_{RMS} versus frequency f (for sinusoidal waveforms $T_A \leq 90\text{ }^\circ\text{C}$)

For $T_A > 90\text{ }^\circ\text{C}$, please use the derating factor F_T .

Lead spacing 10 mm

630 V DC/310 V AC

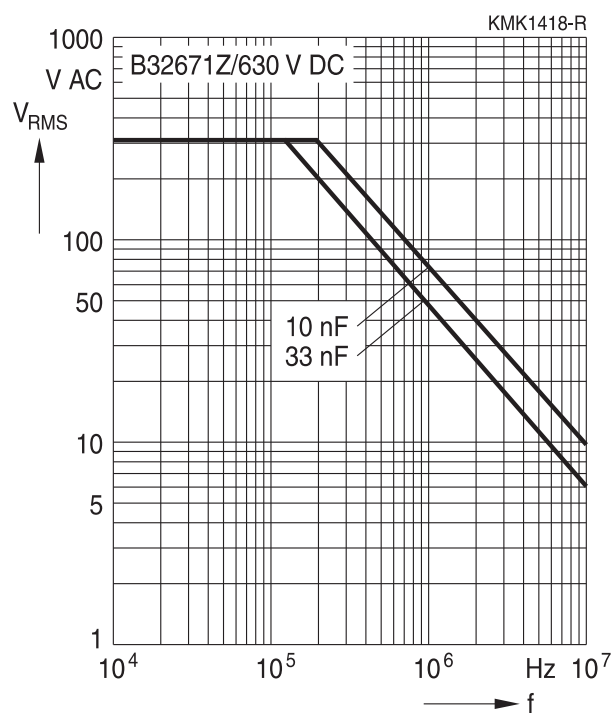

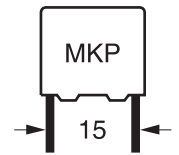
Permissible AC voltage V_{RMS} versus frequency f (for sinusoidal waveforms $T_A \leq 90^\circ C$)

 For $T_A > 90^\circ C$, please use the derating factor F_T .

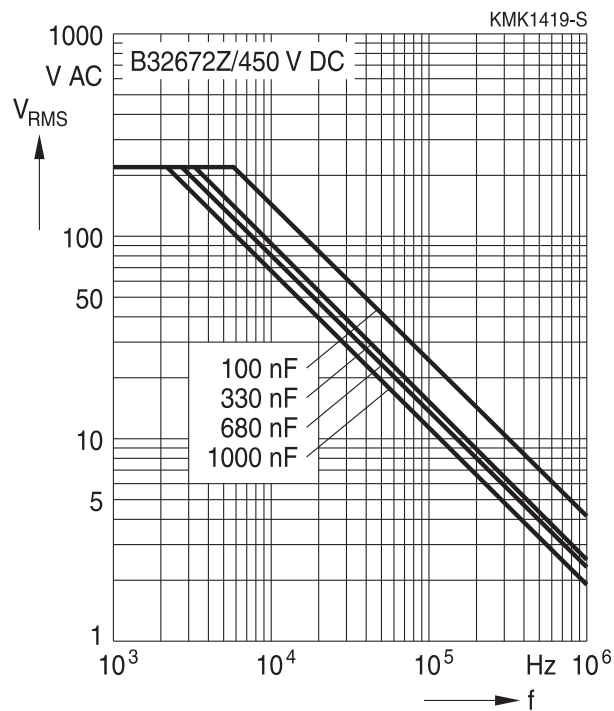
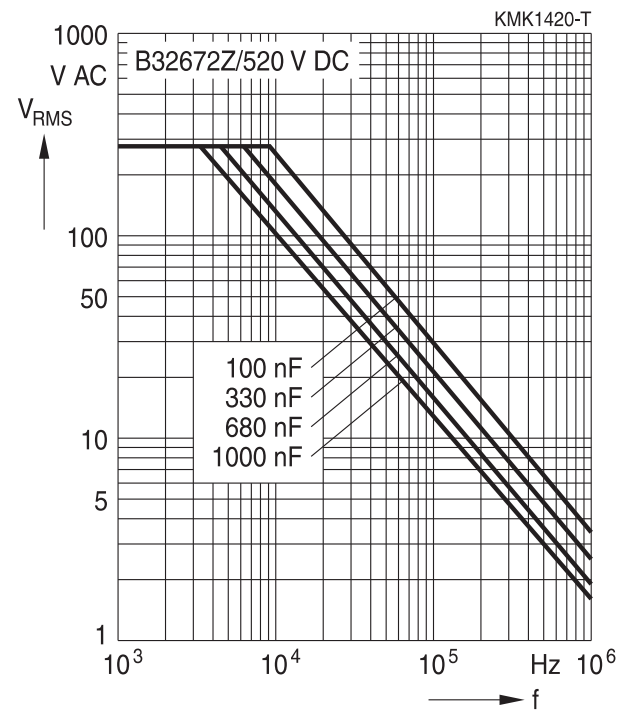
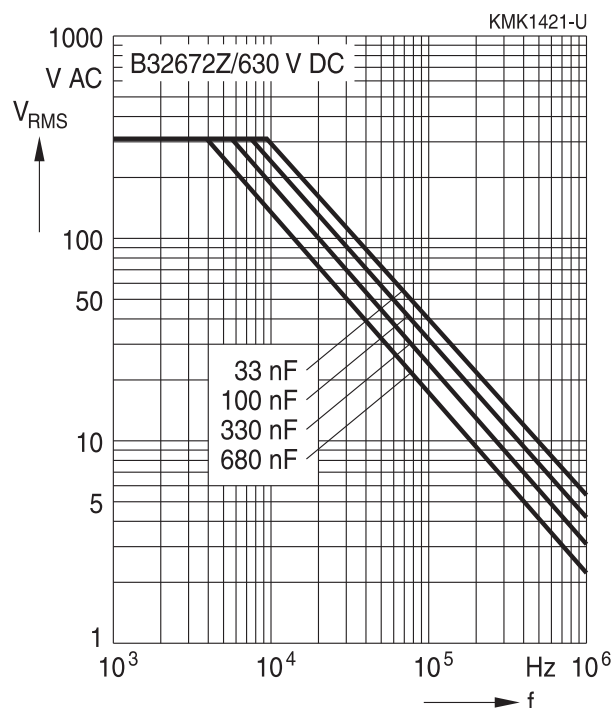
Lead spacing 15 mm
450 V DC/220 V AC

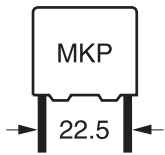
520 V DC/277 V AC

630 V DC/310 V AC



B32673Z

Power Factor Correction

Permissible AC voltage V_{RMS} versus frequency f (for sinusoidal waveforms $T_A \leq 90^\circ C$)

For $T_A > 90^\circ C$, please use the derating factor F_T .

Lead spacing 22.5 mm

450 V DC/220 V AC

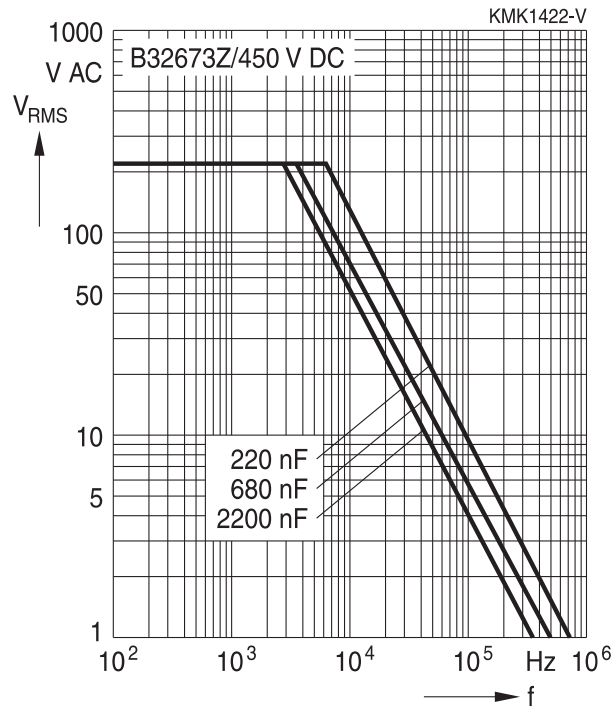

520 V DC/277 V AC

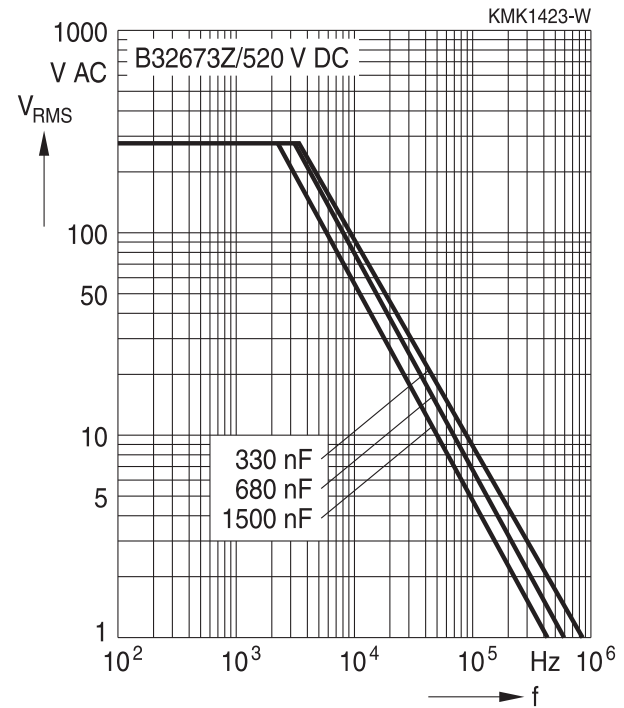

630 V DC/310 V AC

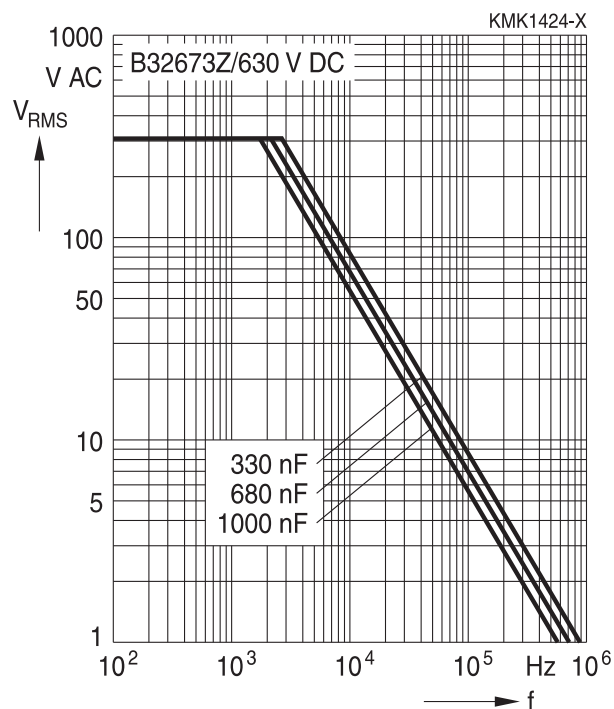

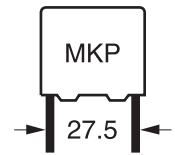

Permissible AC voltage V_{RMS} versus frequency f (for sinusoidal waveforms $T_A \leq 90^\circ C$)

For $T_A > 90^\circ C$, please use the derating factor F_T .

Lead spacing 27.5 mm

450 V DC/220 V AC

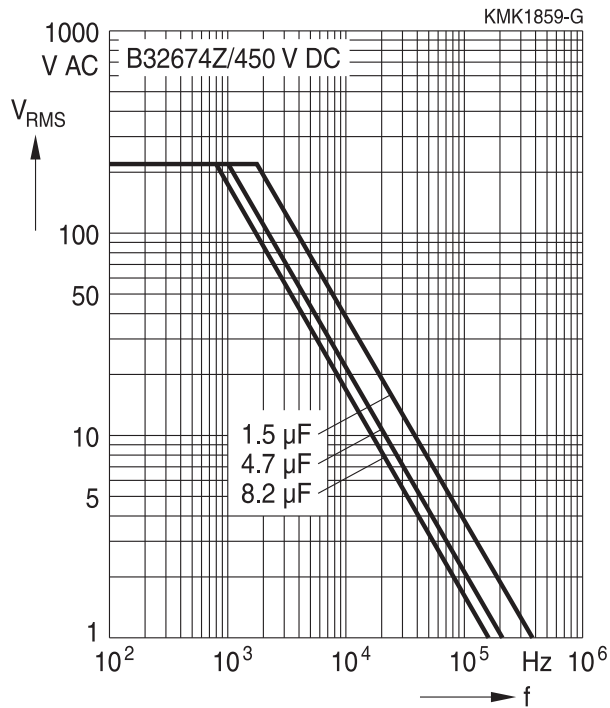

520 V DC/277 V AC

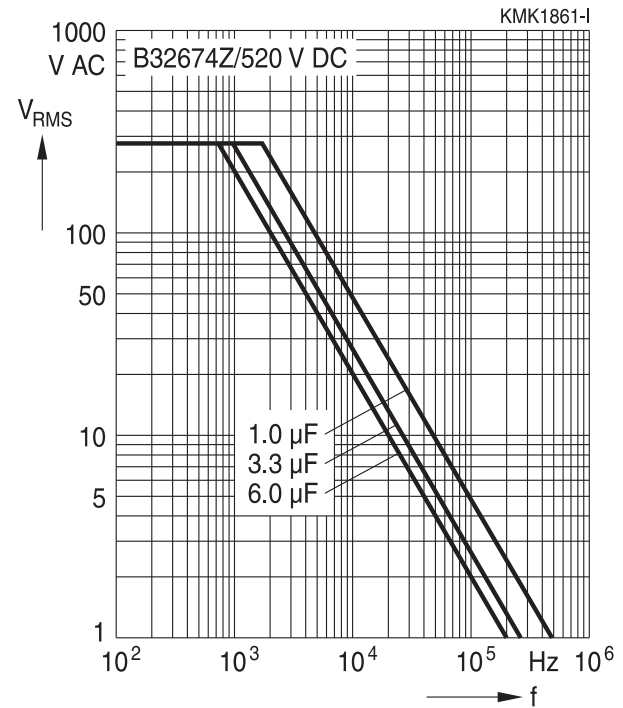

630 V DC/310 V AC

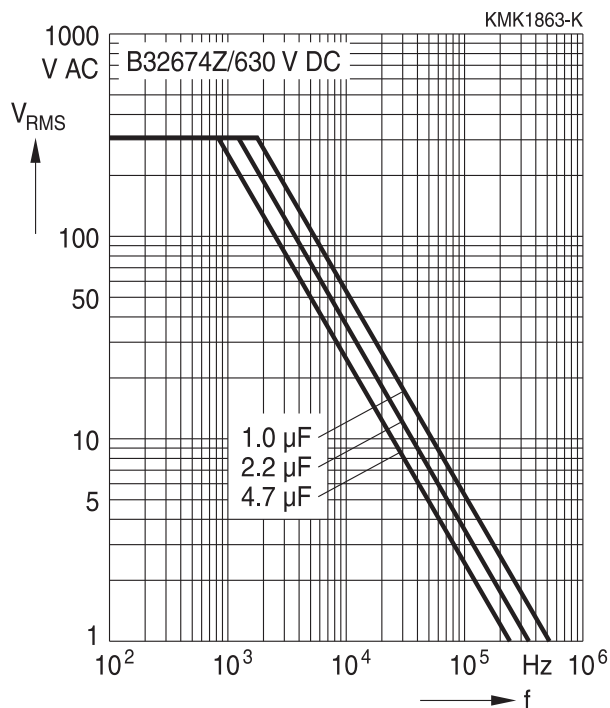

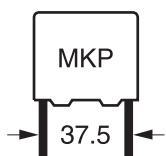

B32676Z

Power Factor Correction

Permissible AC voltage V_{RMS} versus frequency f (for sinusoidal waveforms $T_A \leq 90^\circ C$)

For $T_A > 90^\circ C$, please use the derating factor F_T .

Lead spacing 37.5 mm

450 V DC/220 V AC

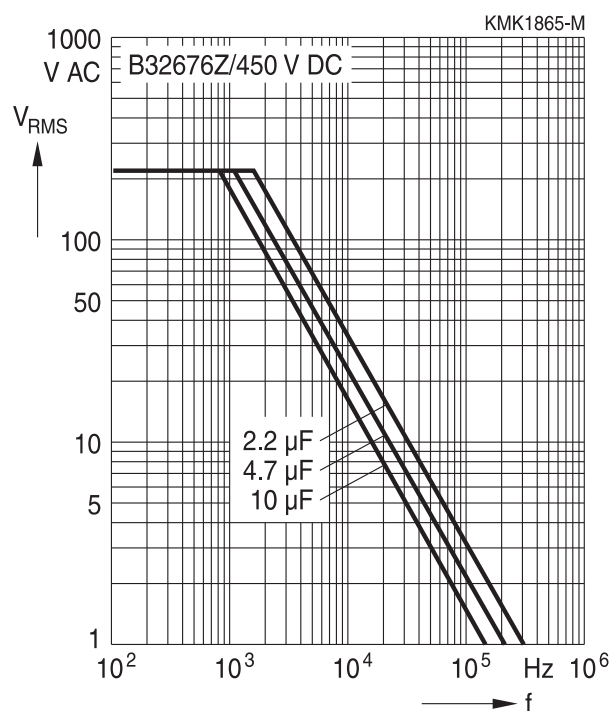

520 V DC/277 V AC

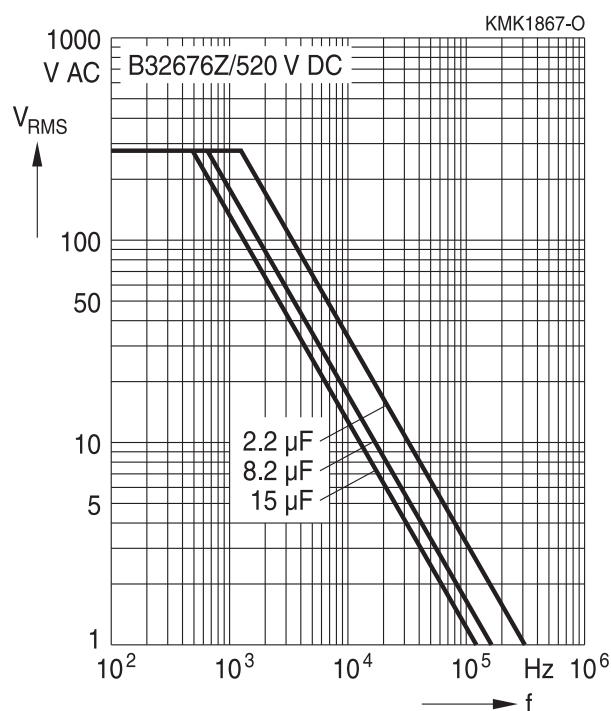

630 V DC/310 V AC

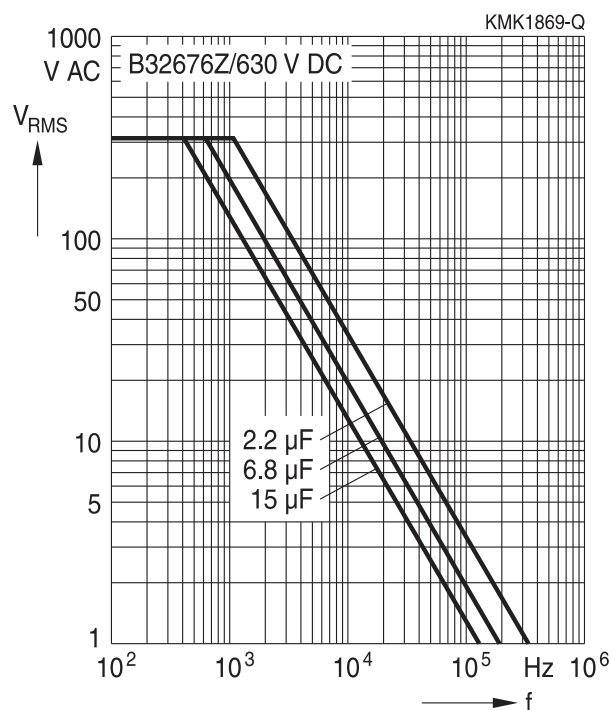

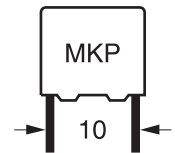

Permissible current I_{RMS} versus frequency f (for sinusoidal waveforms $T_{op} \leq 90\text{ }^\circ\text{C}$)

For $T_A > 90\text{ }^\circ\text{C}$, please use the derating factor F_T .

Lead spacing 10 mm

450 V DC/160 V AC

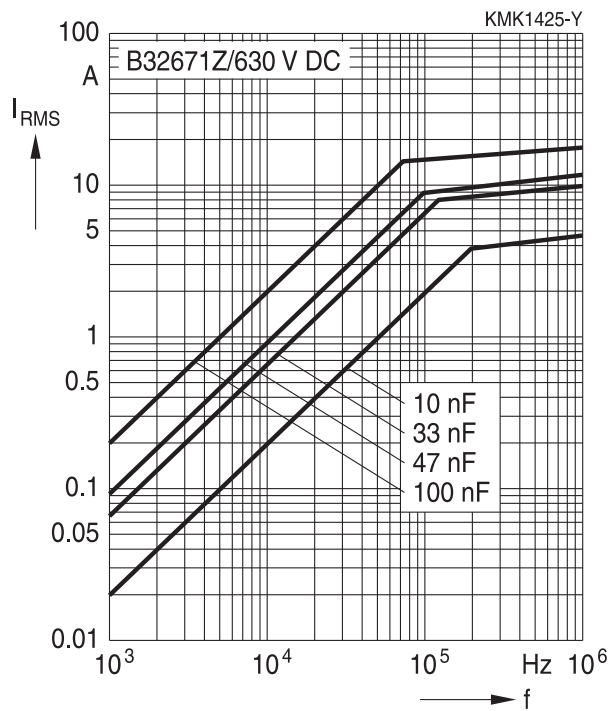

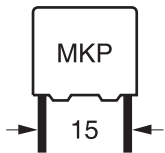

B32672Z

Power Factor Correction

Permissible current I_{RMS} versus frequency f (for sinusoidal waveforms $T_{op} \leq 90\text{ }^{\circ}\text{C}$)

For $T_A > 90\text{ }^{\circ}\text{C}$, please use the derating factor F_T .

Lead spacing 15 mm

450 V DC/160 V AC

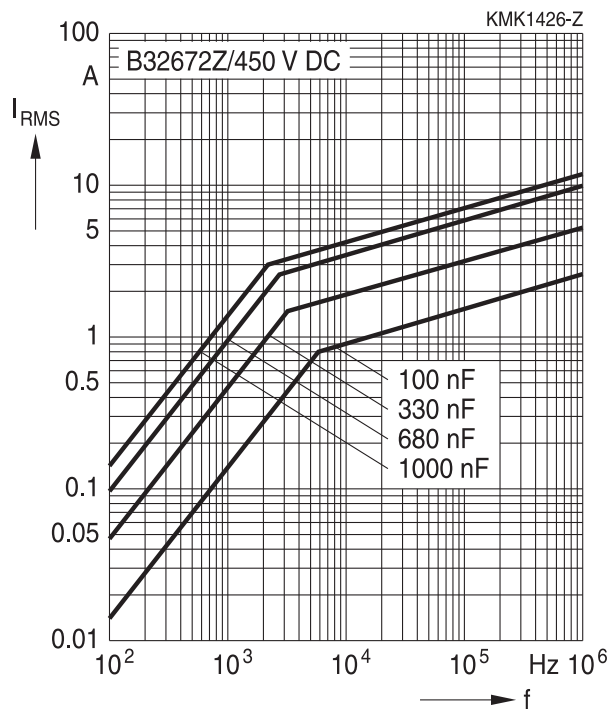

520 V DC/200 V AC

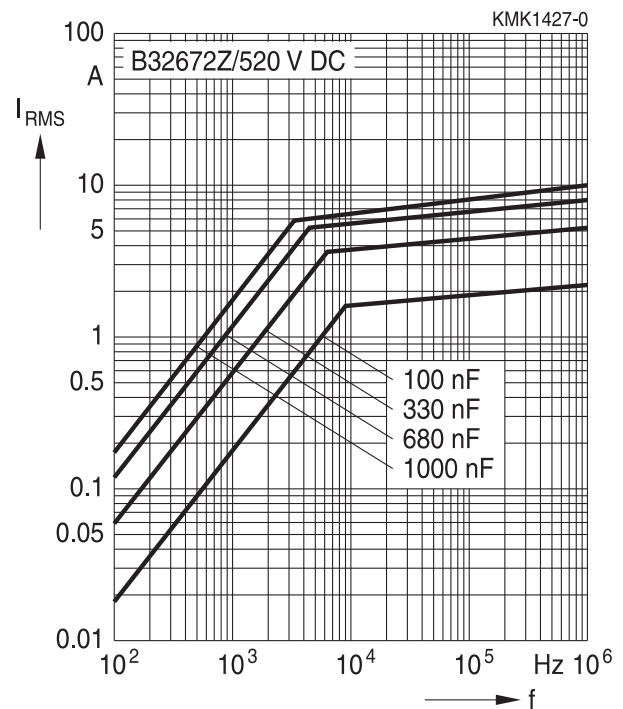

630 V DC/200 V AC

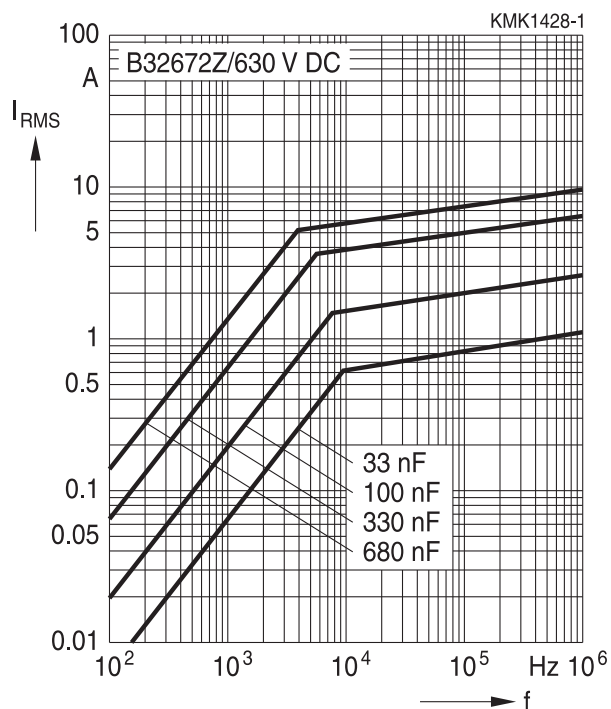

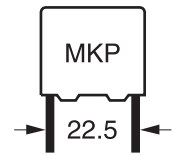

Permissible current I_{RMS} versus frequency f (for sinusoidal waveforms $T_{op} \leq 90^\circ C$)

For $T_A > 90^\circ C$, please use the derating factor F_T .

Lead spacing 22.5 mm

450 V DC/160 V AC

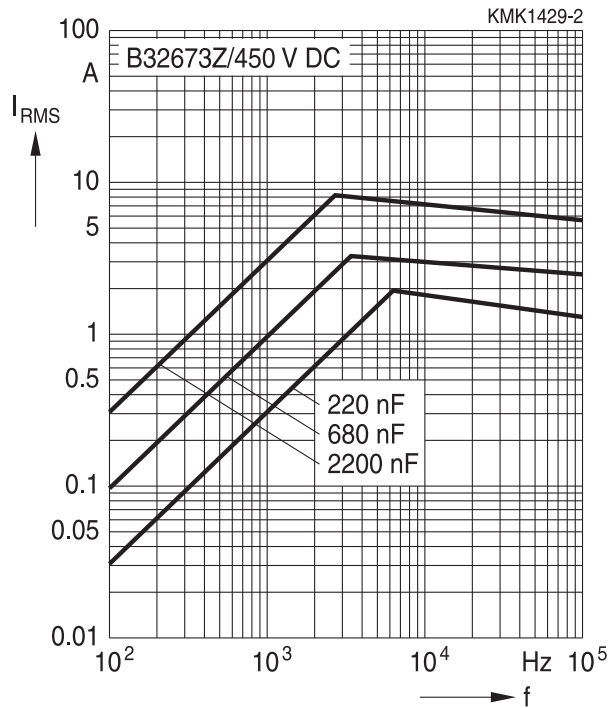

520 V DC/200 V AC

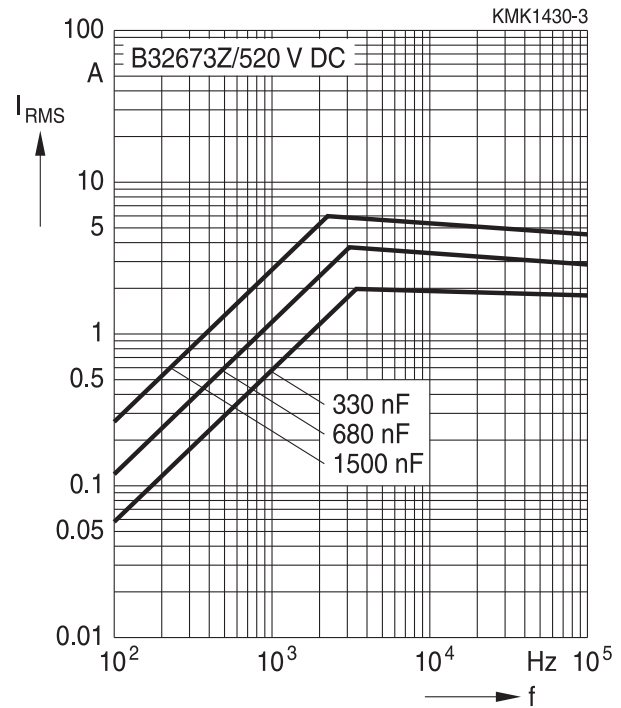

630 V DC/200 V AC

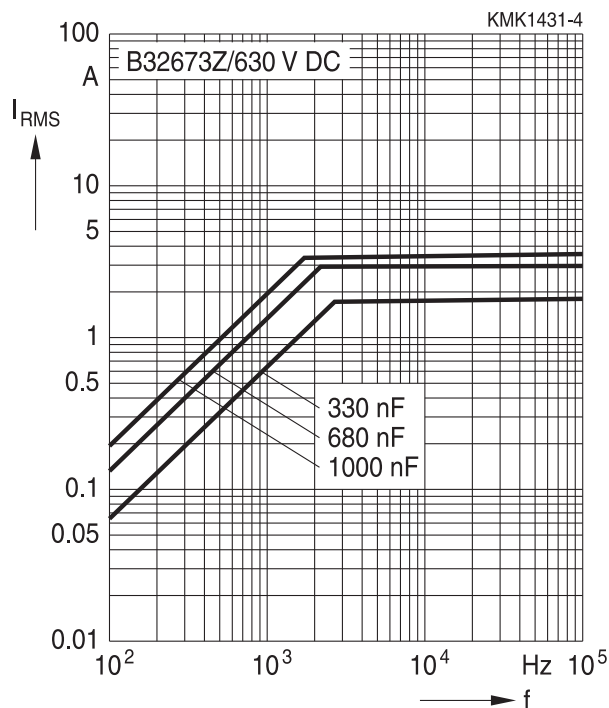

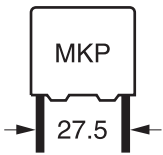

B32674Z

Power Factor Correction

Permissible current I_{RMS} versus frequency f (for sinusoidal waveforms $T_{op} \leq 90\text{ }^\circ\text{C}$)

For $T_A > 90\text{ }^\circ\text{C}$, please use the derating factor F_T .

Lead spacing 27.5 mm

450 V DC/160 V AC

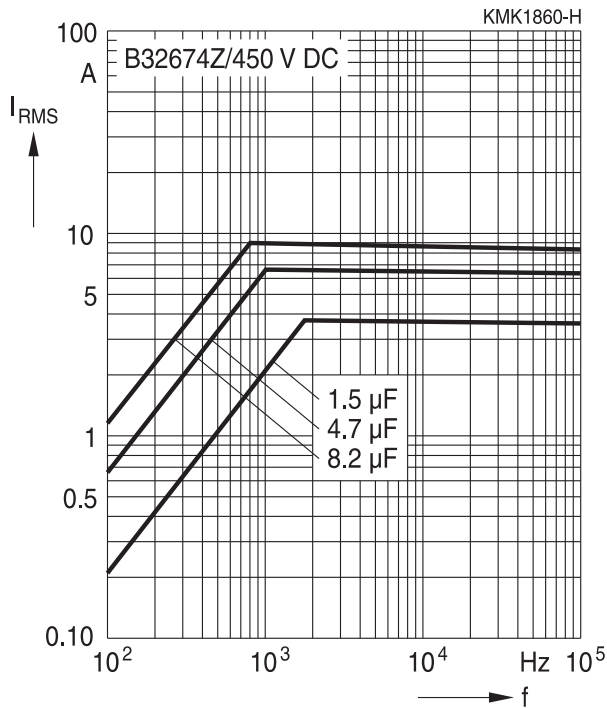

520 V DC/200 V AC

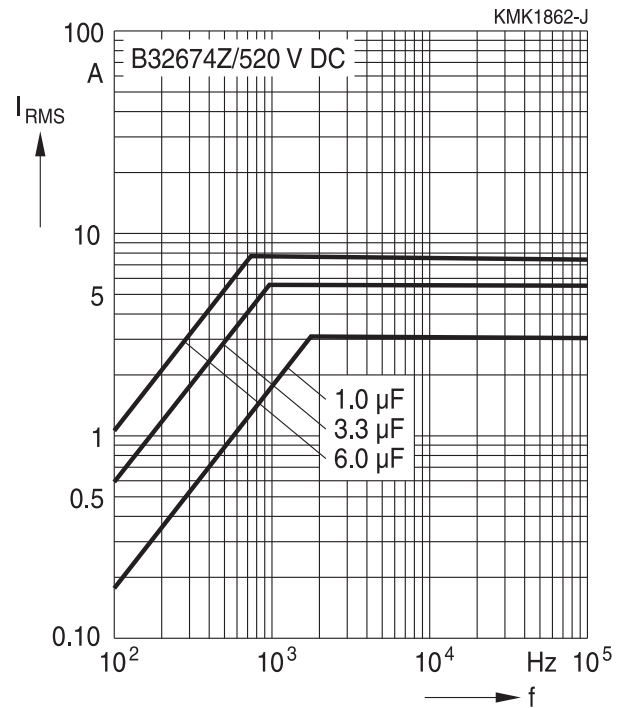

630 V DC/200 V AC

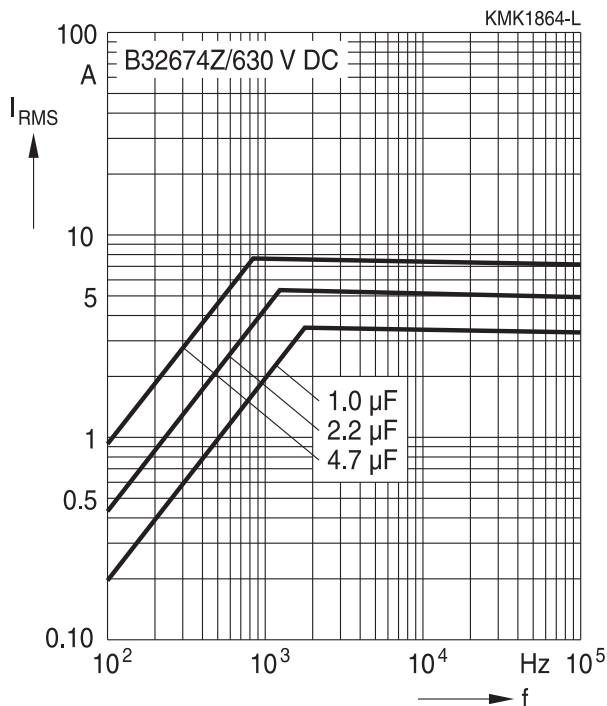

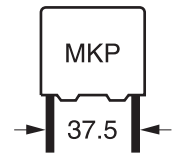

Permissible current I_{RMS} versus frequency f (for sinusoidal waveforms $T_{op} \leq 90^\circ C$)

 For $T_A > 90^\circ C$, please use the derating factor F_T .

Lead spacing 37.5 mm

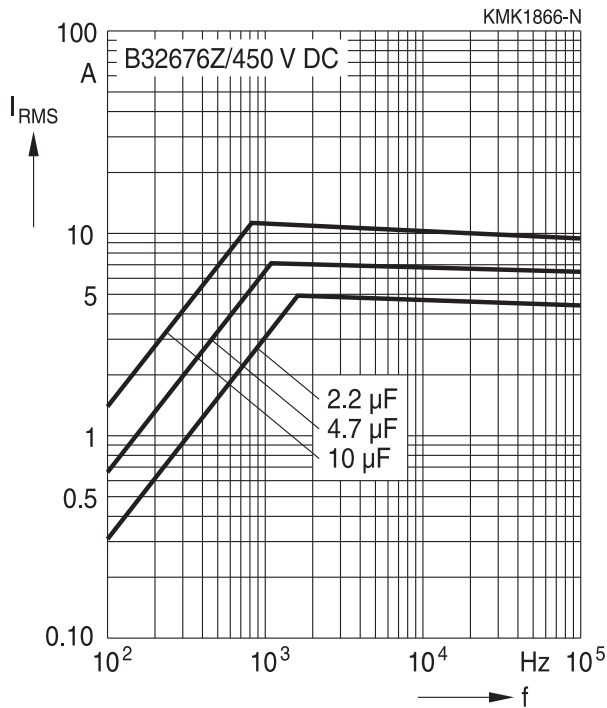
450 V DC/160 V AC



520 V DC/200 V AC

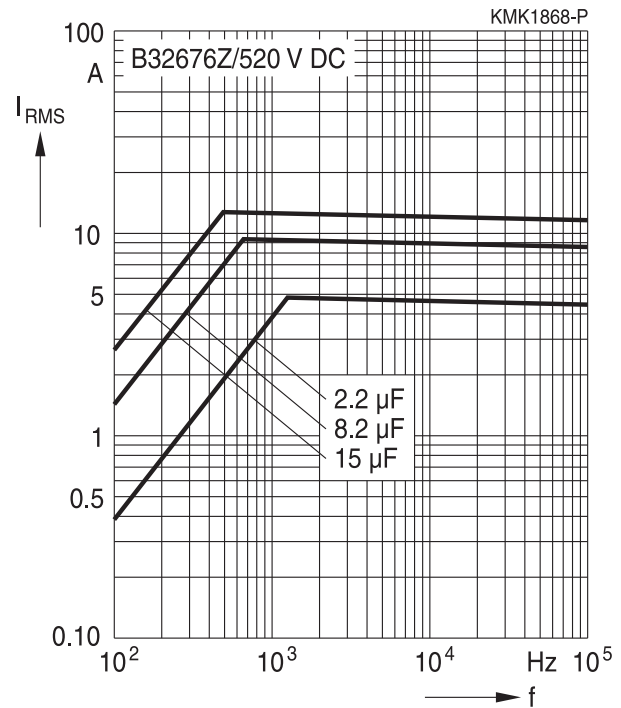

630 V DC/200 V AC

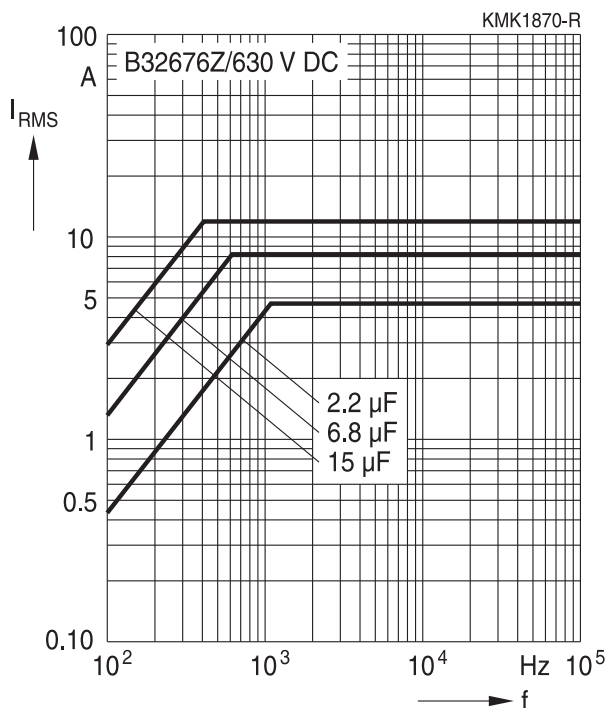

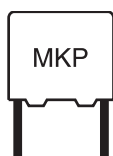

B32671Z ... B32676Z

Power Factor Correction

Maximum AC Voltage (V_{RMS}), Current (I_{RMS}) versus frequency and temperature for $T_A > 90\text{ }^\circ\text{C}$

The graphs described in the previous section for the permissible AC voltage (V_{RMS}) or current (I_{RMS}) versus frequency are given for a maximum ambient temperature $T_A \leq 90\text{ }^\circ\text{C}$. In case of higher ambient temperatures (T_A), the self-heating (ΔT) of the component must be reduced to avoid that temperature of the component ($T_{op} = T_A + \Delta T$) reaches values above maximum operating temperature.

The factor F_T shall be applied in the following way:

$$I_{RMS}(T_A) = I_{RMS, T_A \leq 90\text{ }^\circ\text{C}} \cdot F_T(T_A)$$

$$V_{RMS}(T_A) = V_{RMS, T_A \leq 90\text{ }^\circ\text{C}} \cdot F_T(T_A)$$

F_T is given by the following curve

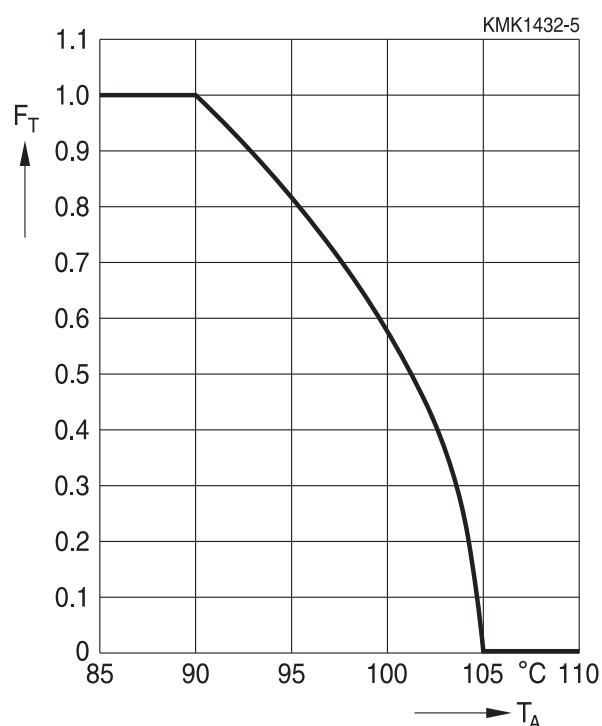

Maximum I_{RMS} current as function of the ambient temperature: $I_{RMS}(T_A) = \text{Factor} \times I_{RMS}(70\text{ }^\circ\text{C})$

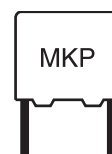

Taping and packing

1 Capacitors with radial leads

Taping to IEC 60286-2:2015.

1.1 Tape dimensions

Lead spacing 5 mm

Types: B32529, B32559 (MKT)

Standard 5 mm
 $P_0 = 12.7$ mm

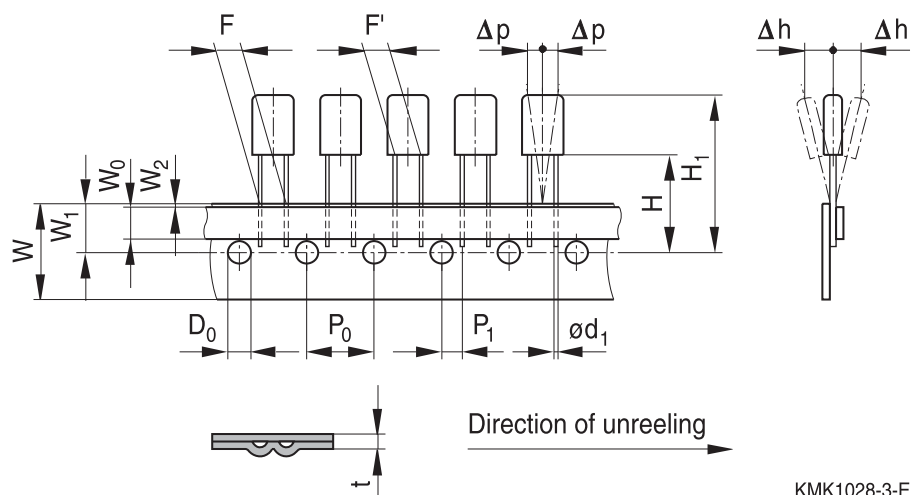

KMK1028-3-E

Dimensions

Symbol	ϕd_1	D_0	F	F'	H	H_1	P_0	P_1
Dimension (mm)	0.5	4.0	5.0	5.0	18.5	32.2	12.7	3.8
Tolerance (mm)	± 0.05	± 0.2	$+0.6/-0.1$	± 0.4	± 0.5	max.	$\pm 0.2^*)$	± 0.7

Symbol	W	W_0	W_1	W_2	t	Δh	Δp
Dimension (mm)	18.0	6.0	9.0	0.5	0.7	0	0
Tolerance (mm)	± 0.5	± 0.5	± 0.5	$+2.5$	± 0.2	± 2.0	± 1.3

$^*) \pm 1$ per $20 \times P_0$

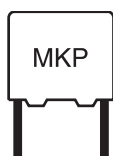

B32671Z ... B32676Z

Power Factor Correction

Lead spacing 7.5 mm

Types: B32520, B32560 (MKT)
B32620 (MKP)

Standard 7.5 mm
 $P_0 = 12.7$ mm

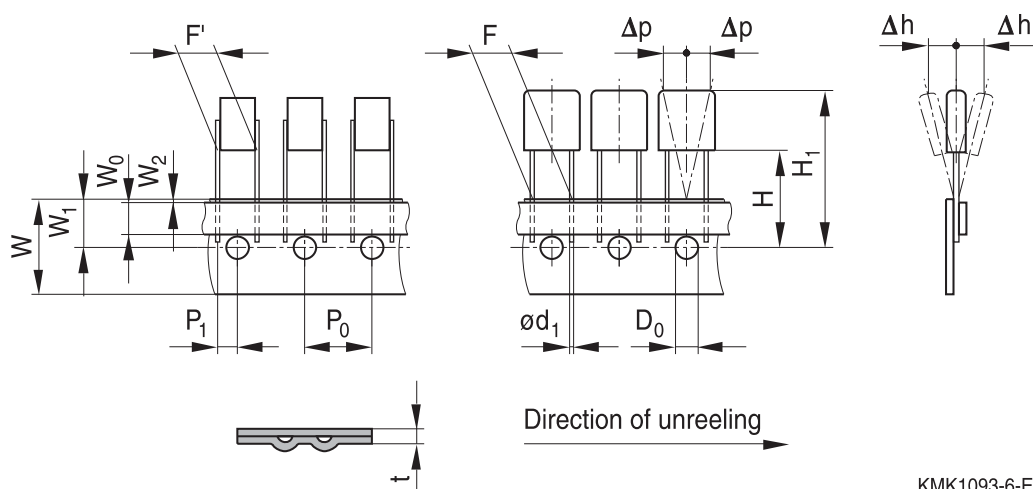

KMK1093-6-E

Dimensions

Symbol	$\varnothing d_1$	D_0	F	F'	H	H_1	P_0	P_1
Dimension (mm)	0.5	4.0	7.5	7.5	18.5	32.2	12.7	3.8
Tolerance (mm)	± 0.05	± 0.2	$+0.6/-0.1$	± 0.4	± 0.5	max.	$\pm 0.2^*)$	± 0.7

Symbol	W	W_0	W_1	W_2	t	Δh	Δp
Dimension (mm)	18.0	6.0	9.0	0.5	0.7	0	0
Tolerance (mm)	± 0.5	± 0.5	± 0.5	$+2.5$	± 0.2	± 2.0	± 1.3

$^*) \pm 1$ per $20 \times P_0$

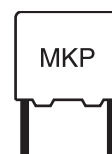
Lead spacing 10 mm

Types:	B32521, B32561 (MKT)
	B32621, B32641, B32651, B32671 (MKP)
	B32021, B32911, B32921 (EMI suppression)

Standard 10 mm

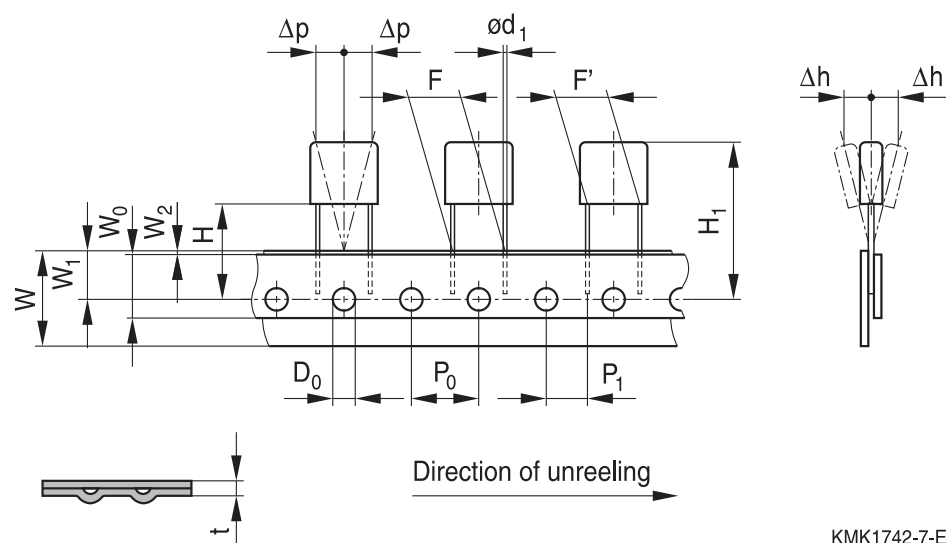
 $P_0 = 12.7 \text{ mm}$

KMK1742-7-E

Dimensions

Symbol	ϕd_1	D_0	F	F'	H	H_1
Dimension (mm)	0.5; 0.6	4.0	10.0	10.0	18.5	32.2
Tolerance (mm)	± 0.05	± 0.2	$+0.6/-0.1$	± 0.4	± 0.5	max.

Symbol	P_0	P_1	W	W_0	W_1	W_2	t	Δh	Δp
Dimension (mm)	12.7	7.7	18.0	12.0	9.0	0.5	0.7	0	0
Tolerance (mm)	$\pm 0.2^*)$	± 0.7	± 0.5	± 0.5	± 0.5	$+2.5$	± 0.2	± 2.0	± 1.3

 $^*) \pm 1 \text{ per } 20 \times P_0$

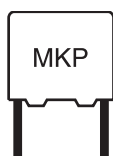

B32671Z ... B32676Z

Power Factor Correction

Lead spacing 15 mm

Types:	B32522, B32562 (MKT)
	B32642, B32652, B32672 (MKP)
	B32682 (MFP)
	B32022, B32912, B32922, B32932, B81123 (EMI suppression)

Standard 15 mm

$P_0 = 12.7$ mm

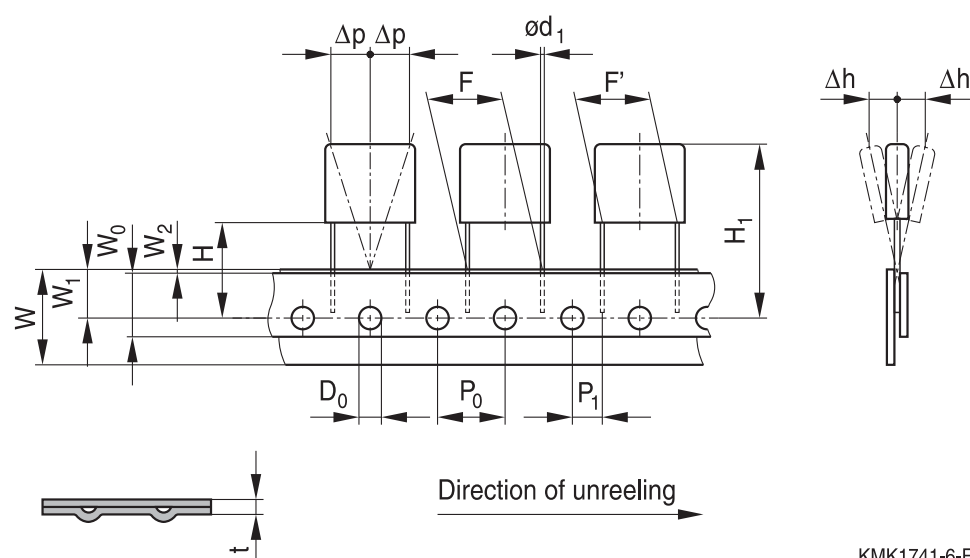

KMK1741-6-E

Dimensions

Symbol	ϕd_1	D_0	F	F'	H	H_1
Dimension (mm)	0.6; 0.8	4.0	15.0	15.0	18.5	37.5
Tolerance (mm)	± 0.05	± 0.2	$+0.6/-0.1$	± 0.4	± 0.5	max.

Symbol	P_0	P_1	W	W_0	W_1	W_2	t	Δh	Δp
Dimension (mm)	12.7	5.2	18.0	12.0	9.0	0.5	0.7	0	0
Tolerance (mm)	$\pm 0.2^*)$	± 0.7	± 0.5	± 0.5	± 0.5	$+2.5$	± 0.2	± 2.0	± 1.3

$^*) \pm 1$ per $20 \times P_0$

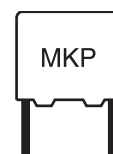
Lead spacing 22.5 mm

Types:	B32523, B32593 (MKT)
	B32613, B32643, B32653, B32673 (MKP)
	B32683 (MFP)
	B32023, B32033, B32913, B32923, B32933, B81123 (EMI suppression)

Standard 22.5 mm

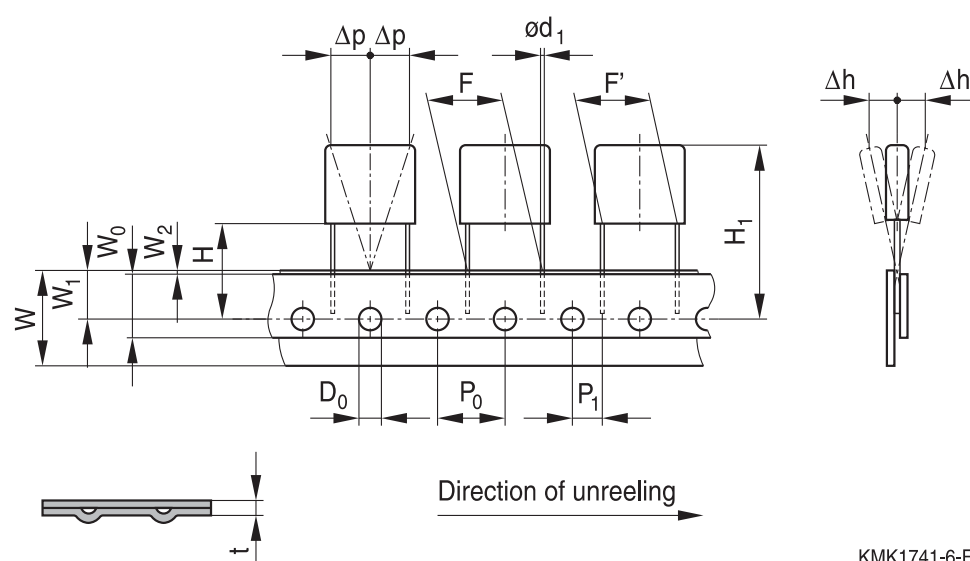
 $P_0 = 12.7$ mm

KMK1741-6-E

Dimensions

Symbol	$\varnothing d_1$	D_0	F	F'	H	H_1
Dimension (mm)	0.8	4.0	22.5	22.5	18.5	39.5
Tolerance (mm)	± 0.05	± 0.2	$+0.6/-0.1$	± 0.4	± 0.5	max.

Symbol	P_0	P_1	W	W_0	W_1	W_2	t	Δh	Δp
Dimension (mm)	12.7	7.8	18.0	12.0	9.0	0.5	0.7	0	0
Tolerance (mm)	$\pm 0.2^*)$	± 0.7	± 0.5	± 0.5	± 0.5	$+2.5$	± 0.2	± 2.0	± 1.3

 $^*) \pm 1$ per $20 \times P_0$

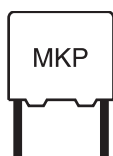

B32671Z ... B32676Z

Power Factor Correction

Lead spacing 27.5 mm

Types:	B32524 (MKT) B32654, B32674, B32774 (MKP) B32684 (MFP) B32024, B32034, B32914, B32924, B32934 (EMI suppression)
--------	--

Standard 27.5 mm
 $P_0 = 12.7$ mm

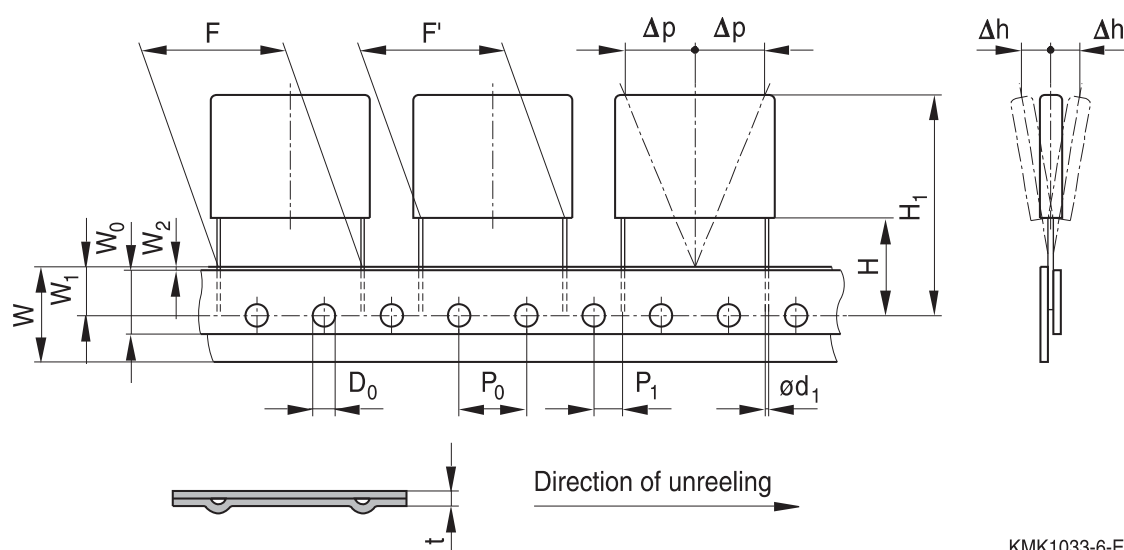

KMK1033-6-E

Dimensions

Symbol	ϕd_1	D_0	F	F'	H	H_1
Dimension (mm)	0.8	4.0	27.5	27.5	18.5	42.0
Tolerance (mm)	± 0.05	± 0.2	$+0.6/-0.1$	± 0.4	± 0.5	max.

Symbol	P_0	P_1	W	W_0	W_1	W_2	t	Δh	Δp
Dimension (mm)	12.7	5.3	18.0	12.0	9.0	0.5	0.7	0	0
Tolerance (mm)	$\pm 0.2^*)$	± 0.7	± 0.5	± 0.5	± 0.5	$+2.5$	± 0.2	± 2.0	± 1.3

^{*)} ± 1 per $20 \times P_0$

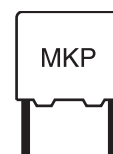

1.2 Crimping

Lead spacing 10 mm crimped down to 7.5 mm

$P_0 = 15.0$ mm, ending code 140 for Reel, ending code 240 for Ammo pack

Standard 10 mm

$P_0 = 15$ mm

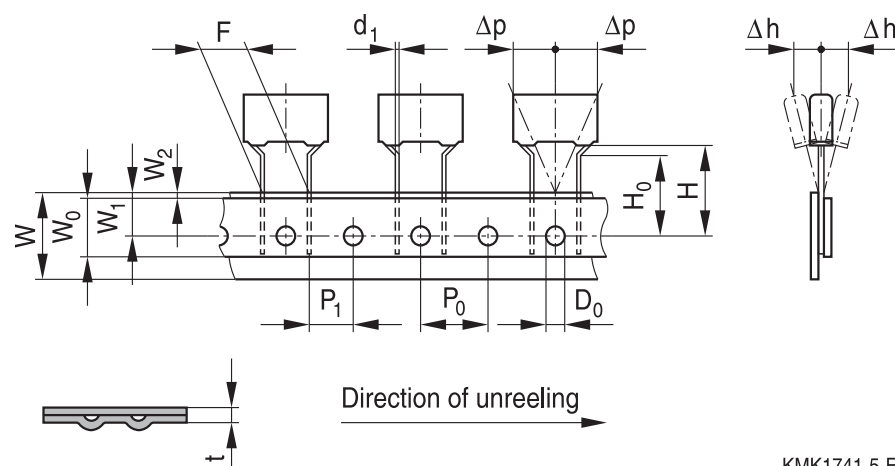

KMK1741-5-E

Symbol	$\varnothing d_1$	D_0	F	H	H_0	P_0	P_1
Dimension (mm)	0.5; 0.6	4.0	7.5	18.5	17.0	15.0	3.75
Tolerance (mm)	± 0.05	± 0.2	$+0.6/-0.1$	± 0.5	± 0.5	$\pm 0.2^{*)}$	± 0.7

Symbol	W	W_0	W_1	W_2	t	Δh	Δp
Dimension (mm)	18.0	12.0	9.0	0.5	0.7	0	0
Tolerance (mm)	± 0.5	± 0.5	± 0.5	$+2.5$	± 0.2	± 2.0	± 1.3

^{*)} ± 1 per $20 \times P_0$

Packing unit and MOQ upon request.

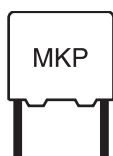

B32671Z ... B32676Z

Power Factor Correction

Lead spacing 15 mm crimped down to 7.5 mm

$P_0 = 15.0$ mm, ending code 155 for Reel, ending code 255 for Ammo pack

Standard 15 mm

$P_0 = 15$ mm

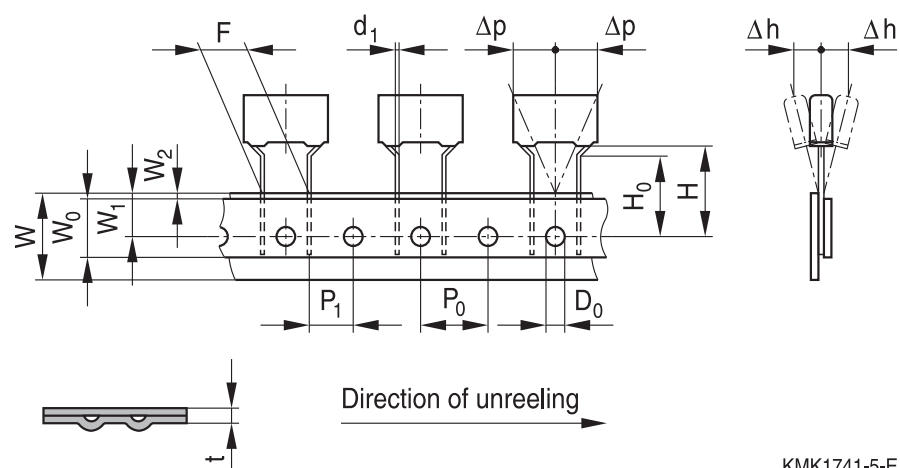

KMK1741-5-E

Symbol	$\varnothing d_1$	D_0	F	H	H_0	P_0	P_1
Dimension (mm)	0.6; 0.8	4.0	7.5	18.5	17.0	15.0	3.75
Tolerance (mm)	± 0.05	± 0.2	$+0.6/-0.1$	± 0.5	± 0.5	$\pm 0.2^{*)}$	± 0.7

Symbol	W	W_0	W_1	W_2	t	Δh	Δp
Dimension (mm)	18.0	12.0	9.0	0.5	0.7	0	0
Tolerance (mm)	± 0.5	± 0.5	± 0.5	$+2.5$	± 0.2	± 2.0	± 1.3

$^{*)} \pm 1$ per $20 \times P_0$

Packing unit and MOQ upon request.

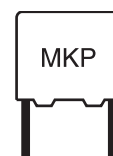

1.3 Packing

Reel packing

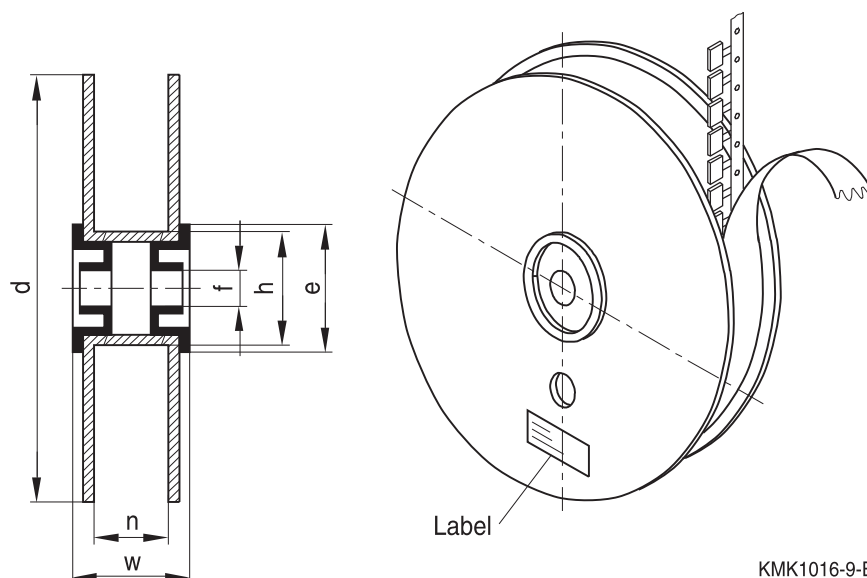

KMK1016-9-E

Dimensions (mm)	n	w	∅ d	∅ e	∅ f	∅ h
Lead spacing ≤7.5	42 +1	52 max.	360 -1	90	30.5 ±0.2	82 +1
Lead spacing 10, 15, 22.5, 27.5	54 +1	70 max.	500 -1	130	30.5 ±0.2	126 +1
<i>On request:</i>						
Lead spacing ≥10	54 +1	70 max.	360 -1	90	30.5 ±0.7	82 +1

Ammo packing

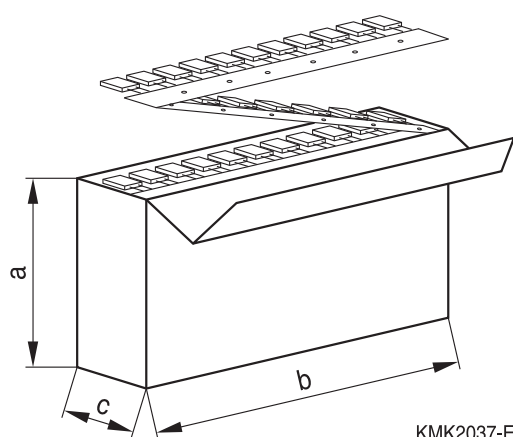

KMK2037-E

Dimensions (approximately)	Lead spacing (mm)							
	5	7.5	15	15	15	22.5	15	22.5
a (mm)	355		355		480		480	
b (mm)	350		350		355		355	
c (mm)	50		60		50		60	

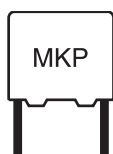

B32671Z ... B32676Z

Power Factor Correction

2 General notes on packing

When packing our products, we pay attention to the needs of the environment by reducing the amount of packing to an absolute minimum and using environmentally compatible materials for packing. In doing so we are also complying with the German packaging legislation which came into force on the 1st December 1991.

In order to further comply with the aims of this legislation concerning the reduction of commercial waste, we have implemented the following measures:

- The use of "Euro" pallets.
- Goods are secured on the pallets using straps and edge protectors made of environmentally compatible plastics (PE or PP).
- The shipping cartons (transport packing) qualify for and carry the RESY logo.
- Separating layers are of paper.
- The shipping cartons are sealed with paper adhesive tape in order to ensure that only a single, uniform material needs to be disposed of.
- We are prepared, on principle, to take back the packing material (especially product-specific plastic packages, e.g. magazines). However, we ask our customers to send cardboard cartons, corrugated cardboard, paper etc. to recycling or disposal companies in order to avoid unnecessary transportation of empty packing materials.

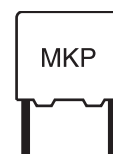
Testing and Standards

Test	Reference	Conditions of test	Performance requirements
Electrical parameters	IEC 60384-1:2016	Voltage proof, $1.6 V_R$, 1 minute Insulation resistance, R_{ins} Capacitance, C Dissipation factor, $\tan \delta$	Within specified limits
Robustness of terminations	IEC 60068-2-21:2006	Tensile strength (test Ua1) Wire diameter Tensile force $0.5 < d1 < 0.8 \text{ mm}$ 10 N	Capacitance and $\tan \delta$ within specified limits
Resistance to soldering heat	IEC 60068-2-20:2008, test Tb, method 1A	Solder bath temperature at $260 \pm 5 \text{ }^\circ\text{C}$, immersion for 10 seconds	$\Delta C/C_0 \leq 2\%$ $ \Delta \tan \delta \leq 0.002$
Rapid change of temperature	IEC 60384-16:2005	T_A = lower category temperature T_B = upper category temperature Five cycles, duration $t = 30 \text{ min.}$	
Vibration	IEC 60384-16:2005	Test F_C : vibration sinusoidal Displacement: 0.75 mm Acceleration: 98 m/s^2 Frequency: 10 Hz ... 500 Hz Test duration: 3 orthogonal axes, 2 hours each axe	No visible damage
Bump	IEC 60384-16:2005	Test E_b : Total 4000 bumps with 390 m/s^2 mounted on PCB Duration: 6 ms	No visible damage $ \Delta C/C_0 \leq 2\%$ $ \Delta \tan \delta \leq 0.002$ $R_{ins} \geq 50\%$ of initial limit
Climatic sequence	IEC 60384-16:2005	Dry heat T_b / 16 h Damp heat cyclic, 1 st cycle $+55 \text{ }^\circ\text{C} / 24 \text{ h} / 95\% \dots 100\% \text{ RH}$ Cold T_a / 2 h Damp heat cyclic, 5 cycles $+55 \text{ }^\circ\text{C} / 24 \text{ h} / 95\% \dots 100\% \text{ RH}$	No visible damage $ \Delta C/C_0 \leq 3\%$ $ \Delta \tan \delta \leq 0.001$ $R_{ins} \geq 50\%$ of initial limit
Damp heat, steady state	IEC 60384-16:2005	Test C_a $40 \text{ }^\circ\text{C} / 93\% \text{ RH} / 56 \text{ days}$	No visible damage $ \Delta C/C_0 \leq 3\%$ $ \Delta \tan \delta \leq 0.001$ $R_{ins} \geq 50\%$ of initial limit
High temperature high humidity with load		$60 \text{ }^\circ\text{C} / 95\% \text{ RH} / 1000 \text{ hours}$ with $V_{R,DC}$	No visible damage $ \Delta C/C_0 \leq 10\%$ $ \Delta \tan \delta \leq 0.004$ $R_{ins} \geq 50\%$ of initial limit

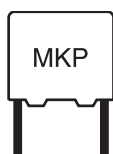

B32671Z ... B32676Z

Power Factor Correction

Test	Reference	Conditions of test	Performance requirements
Endurance	IEC 60384-16:2005	85 °C / 1.25 V _R / 2000 hours	No visible damage ΔC/C ₀ ≤ 5% Δ tan δ ≤ 0.004 R _{ins} ≥ 50% of initial limit
Endurance	IEC 60384-16:2005	110 °C / 1.25 V _C / 2000 hours	No visible damage ΔC/C ₀ ≤ 10% Δ tan δ ≤ 0.004 R _{ins} ≥ 50% of initial limit

Mounting guidelines

1 Soldering

1.1 Solderability of leads

The solderability of terminal leads is tested to IEC 60068-2-20, test Ta, method 1.

Before a solderability test is carried out, terminals are subjected to accelerated ageing (to IEC 60068-2-2, test Ba: 4 h exposure to dry heat at 155 °C). Since the ageing temperature is far higher than the upper category temperature of the capacitors, the terminal wires should be cut off from the capacitor before the ageing procedure to prevent the solderability being impaired by the products of any capacitor decomposition that might occur.

Solder bath temperature	235 ±5 °C
Soldering time	2.0 ±0.5 s
Immersion depth	2.0 +0/−0.5 mm from capacitor body or seating plane
Evaluation criteria:	
Visual inspection	Wetting of wire surface by new solder ≥90%, free-flowing solder

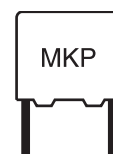

B32671Z ... B32676Z
Power Factor Correction

1.2 Resistance to soldering heat

Resistance to soldering heat is tested to IEC 60068-2-20, test Tb, method 1.

Conditions:

Series	Solder bath temperature	Soldering time
MKT boxed (except 2.5 × 6.5 × 7.2 mm) coated uncoated (lead spacing >10 mm)	260 ±5 °C	10 ±1 s
MFP		
MKP (lead spacing >7.5 mm)		
MKT boxed (case 2.5 × 6.5 × 7.2 mm)	260 ±5 °C	5 ±1 s
MKP (lead spacing ≤7.5 mm)		<4 s
MKT uncoated (lead spacing ≤10 mm) insulated (B32559)		recommended soldering profile for MKT uncoated (lead spacing ≤ 10 mm) and insulated (B32559)

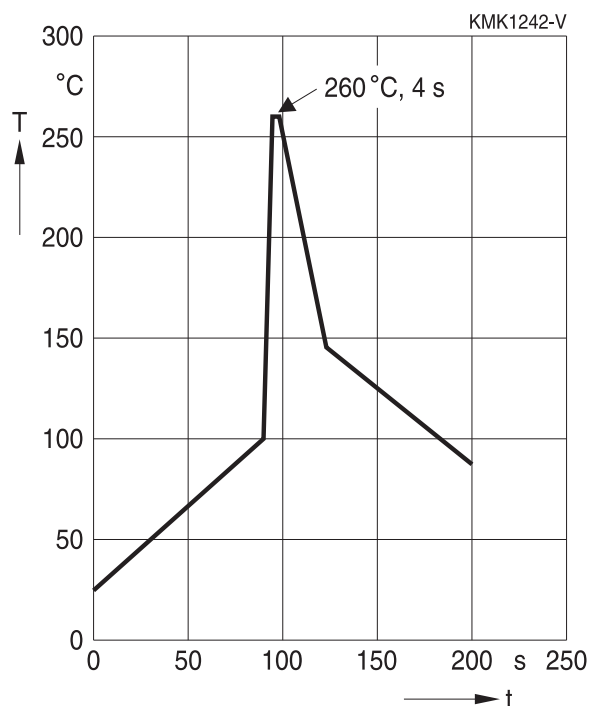

Immersion depth	2.0 +0/−0.5 mm from capacitor body or seating plane
Shield	Heat-absorbing board, (1.5 ±0.5) mm thick, between capacitor body and liquid solder
Evaluation criteria:	
Visual inspection	No visible damage
$\Delta C/C_0$	2% for MKT/MKP/MFP 5% for EMI suppression capacitors
$\tan \delta$	As specified in sectional specification

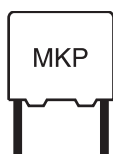

B32671Z ... B32676Z

Power Factor Correction

1.3 General notes on soldering

Permissible heat exposure loads on film capacitors are primarily characterized by the upper category temperature T_{max} . Long exposure to temperatures above this type-related temperature limit can lead to changes in the plastic dielectric and thus change irreversibly a capacitor's electrical characteristics. For short exposures (as in practical soldering processes) the heat load (and thus the possible effects on a capacitor) will also depend on other factors like:

- Pre-heating temperature and time
- Forced cooling immediately after soldering
- Terminal characteristics:
diameter, length, thermal resistance, special configurations (e.g. crimping)
- Height of capacitor above solder bath
- Shadowing by neighboring components
- Additional heating due to heat dissipation by neighboring components
- Use of solder-resist coatings

The overheating associated with some of these factors can usually be reduced by suitable countermeasures. For example, if a pre-heating step cannot be avoided, an additional or reinforced cooling process may possibly have to be included.

EPCOS recommendations

As a reference, the recommended wave soldering profile for our film capacitors is as follows:

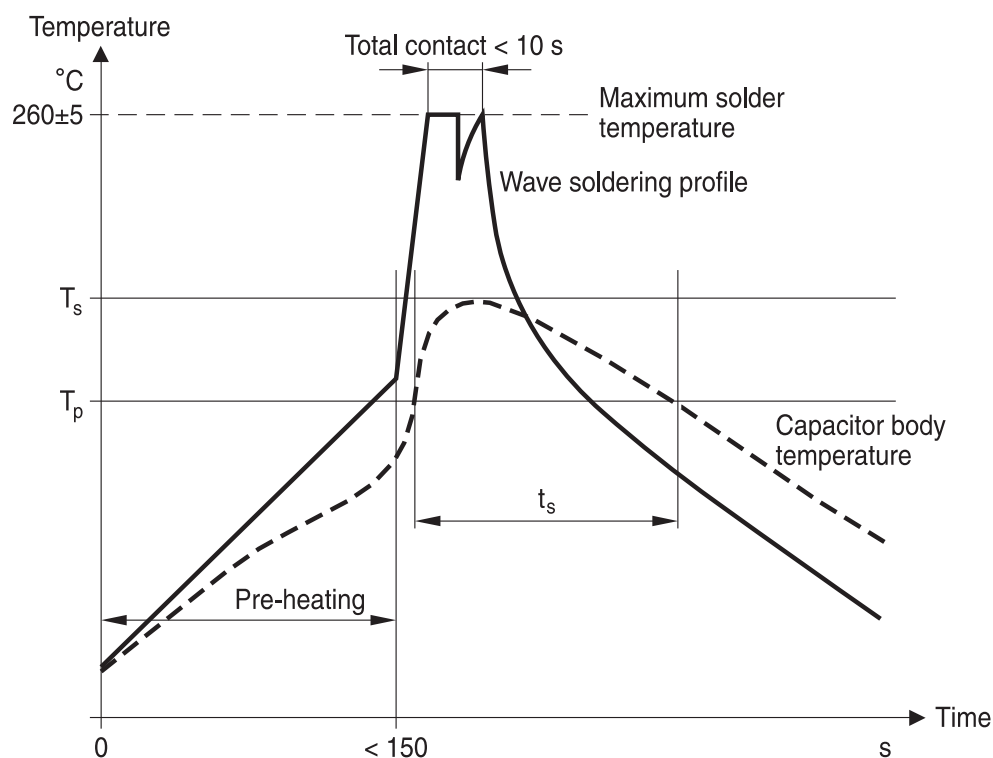

T_s : Capacitor body maximum temperature at wave soldering

T_p : Capacitor body maximum temperature at pre-heating

KMK1745-A-E

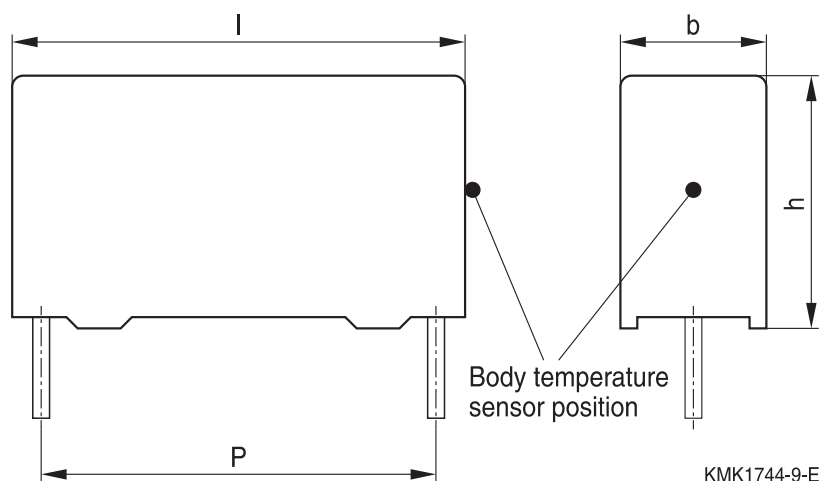
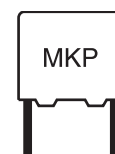

Body temperature should follow the description below:

- MKP capacitor
 - During pre-heating: $T_p \leq 110 \text{ }^\circ\text{C}$
 - During soldering: $T_s \leq 120 \text{ }^\circ\text{C}$, $t_s \leq 45 \text{ s}$
- MKT capacitor
 - During pre-heating: $T_p \leq 125 \text{ }^\circ\text{C}$
 - During soldering: $T_s \leq 160 \text{ }^\circ\text{C}$, $t_s \leq 45 \text{ s}$

When SMD components are used together with leaded ones, the film capacitors should not pass into the SMD adhesive curing oven. The leaded components should be assembled after the SMD curing step.

Leaded film capacitors are not suitable for reflow soldering.

In order to ensure proper conditions for manual or selective soldering, the body temperature of the capacitor (T_s) must be $\leq 120 \text{ }^\circ\text{C}$.

One recommended condition for manual soldering is that the tip of the soldering iron should be $< 360 \text{ }^\circ\text{C}$ and the soldering contact time should be no longer than 3 seconds.

For uncoated MKT capacitors with lead spacings $\leq 10 \text{ mm}$ (B32560/B32561) the following measures are recommended:

- pre-heating to not more than $110 \text{ }^\circ\text{C}$ in the preheater phase
- rapid cooling after soldering

Please refer to EPCOS Film Capacitor Data Book in case more details are needed.

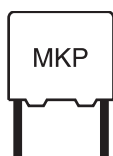

B32671Z ... B32676Z

Power Factor Correction

Cautions and warnings

- Do not exceed the upper category temperature (UCT).
- Do not apply any mechanical stress to the capacitor terminals.
- Avoid any compressive, tensile or flexural stress.
- Do not move the capacitor after it has been soldered to the PC board.
- Do not pick up the PC board by the soldered capacitor.
- Do not place the capacitor on a PC board whose PTH hole spacing differs from the specified lead spacing.
- Do not exceed the specified time or temperature limits during soldering.
- Avoid external energy inputs, such as fire or electricity.
- Avoid overload of the capacitors.
- Consult us if application is with severe temperature and humidity condition.
- There are no serviceable or repairable parts inside the capacitor. Opening the capacitor or any attempts to open or repair the capacitor will void the warranty and liability of EPCOS.
- Please note that the standards referred to in this publication may have been revised in the meantime.

The table below summarizes the safety instructions that must always be observed. A detailed description can be found in the relevant sections of the chapters "General technical information" and "Mounting guidelines".

Topic	Safety information	Reference chapter "General technical information"
Storage conditions	Make sure that capacitors are stored within the specified range of time, temperature and humidity conditions.	4.5 "Storage conditions"
Flammability	Avoid external energy, such as fire or electricity (passive flammability), avoid overload of the capacitors (active flammability) and consider the flammability of materials.	5.3 "Flammability"
Resistance to vibration	Do not exceed the tested ability to withstand vibration. The capacitors are tested to IEC 60068-2-6:2007. EPCOS offers film capacitors specially designed for operation under more severe vibration regimes such as those found in automotive applications. Consult our catalog "Film Capacitors for Automotive Electronics".	5.2 "Resistance to vibration"

Topic	Safety information	Reference chapter "Mounting guidelines"
Soldering	Do not exceed the specified time or temperature limits during soldering.	1 "Soldering"
Cleaning	Use only suitable solvents for cleaning capacitors.	2 "Cleaning"

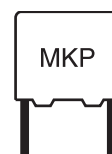

Topic	Safety information	Reference chapter "Mounting guidelines"
Embedding of capacitors in finished assemblies	When embedding finished circuit assemblies in plastic resins, chemical and thermal influences must be taken into account. Caution: Consult us first, if you also wish to embed other uncoated component types!	3 "Embedding of capacitors in finished assemblies"

Display of ordering codes for EPCOS products

The ordering code for one and the same product can be represented differently in data sheets, data books, other publications and the website of EPCOS, or in order-related documents such as shipping notes, order confirmations and product labels. **The varying representations of the ordering codes are due to different processes employed and do not affect the specifications of the respective products.** Detailed information can be found on the Internet under www.epcos.com/orderingcodes.

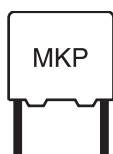

B32671Z ... B32676Z

Power Factor Correction

Symbols and terms

Symbol	English	German
α	Heat transfer coefficient	Wärmeübergangszahl
α_C	Temperature coefficient of capacitance	Temperaturkoeffizient der Kapazität
A	Capacitor surface area	Kondensatoroberfläche
β_C	Humidity coefficient of capacitance	Feuchtekoeffizient der Kapazität
C	Capacitance	Kapazität
C_R	Rated capacitance	Nennkapazität
ΔC	Absolute capacitance change	Absolute Kapazitätsänderung
$\Delta C/C$	Relative capacitance change (relative deviation of actual value)	Relative Kapazitätsänderung (relative Abweichung vom Ist-Wert)
$\Delta C/C_R$	Capacitance tolerance (relative deviation from rated capacitance)	Kapazitätstoleranz (relative Abweichung vom Nennwert)
dt	Time differential	Differentielle Zeit
Δt	Time interval	Zeitintervall
ΔT	Absolute temperature change (self-heating)	Absolute Temperaturänderung (Selbsterwärmung)
$\Delta \tan \delta$	Absolute change of dissipation factor	Absolute Änderung des Verlustfaktors
ΔV	Absolute voltage change	Absolute Spannungsänderung
dV/dt	Time differential of voltage function (rate of voltage rise)	Differentielle Spannungsänderung (Spannungsflankensteilheit)
$\Delta V/\Delta t$	Voltage change per time interval	Spannungsänderung pro Zeitintervall
E	Activation energy for diffusion	Aktivierungsenergie zur Diffusion
ESL	Self-inductance	Eigeninduktivität
ESR	Equivalent series resistance	Ersatz-Serienwiderstand
f	Frequency	Frequenz
f_1	Frequency limit for reducing permissible AC voltage due to thermal limits	Grenzfrequenz für thermisch bedingte Reduzierung der zulässigen Wechselspannung
f_2	Frequency limit for reducing permissible AC voltage due to current limit	Grenzfrequenz für strombedingte Reduzierung der zulässigen Wechselspannung
f_r	Resonant frequency	Resonanzfrequenz
F_D	Thermal acceleration factor for diffusion	Therm. Beschleunigungsfaktor zur Diffusion
F_T	Derating factor	Deratingfaktor
i	Current (peak)	Stromspitze
I_C	Category current (max. continuous current)	Kategoriestrom (max. Dauerstrom)

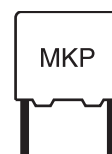

Symbol	English	German
I_{RMS}	(Sinusoidal) alternating current, root-mean-square value	(Sinusförmiger) Wechselstrom
i_z	Capacitance drift	Inkonstanz der Kapazität
k_0	Pulse characteristic	Impuls Kennwert
L_S	Series inductance	Serieninduktivität
λ	Failure rate	Ausfallrate
λ_0	Constant failure rate during useful service life	Konstante Ausfallrate in der Nutzungsphase
λ_{test}	Failure rate, determined by tests	Experimentell ermittelte Ausfallrate
P_{diss}	Dissipated power	Abgegebene Verlustleistung
P_{gen}	Generated power	Erzeugte Verlustleistung
Q	Heat energy	Wärmeenergie
ρ	Density of water vapor in air	Dichte von Wasserdampf in Luft
R	Universal molar constant for gases	Allg. Molarkonstante für Gas
R	Ohmic resistance of discharge circuit	Ohmscher Widerstand des Entladekreises
R_i	Internal resistance	Innenwiderstand
R_{ins}	Insulation resistance	Isolationswiderstand
R_P	Parallel resistance	Parallelwiderstand
R_S	Series resistance	Serienwiderstand
S	severity (humidity test)	Schärfegrad (Feuchtetest)
t	Time	Zeit
T	Temperature	Temperatur
τ	Time constant	Zeitkonstante
$\tan \delta$	Dissipation factor	Verlustfaktor
$\tan \delta_D$	Dielectric component of dissipation factor	Dielektrischer Anteil des Verlustfaktors
$\tan \delta_P$	Parallel component of dissipation factor	Parallelanteil des Verlustfaktors
$\tan \delta_S$	Series component of dissipation factor	Serienanteil des Verlustfaktors
T_A	Temperature of the air surrounding the component	Temperatur der Luft, die das Bauteil umgibt
T_{max}	Upper category temperature	Obere Kategorietemperatur
T_{min}	Lower category temperature	Untere Kategorietemperatur
t_{OL}	Operating life at operating temperature and voltage	Betriebszeit bei Betriebstemperatur und -spannung
T_{op}	Operating temperature, $T_A + \Delta T$	Betriebstemperatur, $T_A + \Delta T$
T_R	Rated temperature	Nenntemperatur
T_{ref}	Reference temperature	Referenztemperatur
t_{SL}	Reference service life	Referenz-Lebensdauer

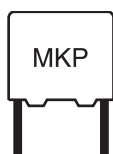

B32671Z ... B32676Z

Power Factor Correction

Symbol	English	German
V_{AC}	AC voltage	Wechselspannung
V_C	Category voltage	Kategorie spannung
$V_{C,RMS}$	Category AC voltage	(Sinusförmige) Kategorie-Wechselspannung
V_{CD}	Corona-discharge onset voltage	Teilentlade-Einsatzspannung
V_{ch}	Charging voltage	Ladespannung
V_{DC}	DC voltage	Gleichspannung
V_{FB}	Fly-back capacitor voltage	Spannung (Flyback)
V_i	Input voltage	Eingangsspannung
V_o	Output voltage	Ausgangsspannung
V_{op}	Operating voltage	Betriebsspannung
V_p	Peak pulse voltage	Impuls-Spitzen spannung
V_{pp}	Peak-to-peak voltage Impedance	Spannungshub
V_R	Rated voltage	Nennspannung
\hat{V}_R	Amplitude of rated AC voltage	Amplitude der Nenn-Wechselspannung
V_{RMS}	(Sinusoidal) alternating voltage, root-mean-square value	(Sinusförmige) Wechselspannung
V_{SC}	S-correction voltage	Spannung bei Anwendung "S-correction"
V_{sn}	Snubber capacitor voltage	Spannung bei Anwendung "Beschaltung"
Z	Impedance	Scheinwiderstand
e	Lead spacing	Rastermaß

Important notes

The following applies to all products named in this publication:

1. Some parts of this publication contain **statements about the suitability of our products for certain areas of application**. These statements are based on our knowledge of typical requirements that are often placed on our products in the areas of application concerned. We nevertheless expressly point out **that such statements cannot be regarded as binding statements about the suitability of our products for a particular customer application**. As a rule, EPCOS is either unfamiliar with individual customer applications or less familiar with them than the customers themselves. For these reasons, it is always ultimately incumbent on the customer to check and decide whether an EPCOS product with the properties described in the product specification is suitable for use in a particular customer application.
2. We also point out that **in individual cases, a malfunction of electronic components or failure before the end of their usual service life cannot be completely ruled out in the current state of the art, even if they are operated as specified**. In customer applications requiring a very high level of operational safety and especially in customer applications in which the malfunction or failure of an electronic component could endanger human life or health (e.g. in accident prevention or lifesaving systems), it must therefore be ensured by means of suitable design of the customer application or other action taken by the customer (e.g. installation of protective circuitry or redundancy) that no injury or damage is sustained by third parties in the event of malfunction or failure of an electronic component.
3. **The warnings, cautions and product-specific notes must be observed.**
4. In order to satisfy certain technical requirements, **some of the products described in this publication may contain substances subject to restrictions in certain jurisdictions (e.g. because they are classed as hazardous)**. Useful information on this will be found in our Material Data Sheets on the Internet (www.epcos.com/material). Should you have any more detailed questions, please contact our sales offices.
5. We constantly strive to improve our products. Consequently, **the products described in this publication may change from time to time**. The same is true of the corresponding product specifications. Please check therefore to what extent product descriptions and specifications contained in this publication are still applicable before or when you place an order. We also **reserve the right to discontinue production and delivery of products**. Consequently, we cannot guarantee that all products named in this publication will always be available. The aforementioned does not apply in the case of individual agreements deviating from the foregoing for customer-specific products.
6. Unless otherwise agreed in individual contracts, **all orders are subject to the current version of the "General Terms of Delivery for Products and Services in the Electrical Industry" published by the German Electrical and Electronics Industry Association (ZVEI)**.



Important notes

7. **Our manufacturing sites serving the automotive business apply the IATF 16949 standard.** The IATF certifications confirm our compliance with requirements regarding the quality management system in the automotive industry. Referring to customer requirements and customer specific requirements (“CSR”) TDK always has and will continue to have the policy of respecting individual agreements. Even if IATF 16949 may appear to support the acceptance of unilateral requirements, we hereby like to emphasize that **only requirements mutually agreed upon can and will be implemented in our Quality Management System.** For clarification purposes we like to point out that obligations from IATF 16949 shall only become legally binding if individually agreed upon.
8. The trade names EPCOS, CeraCharge, CeraDiode, CeraLink, CeraPad, CeraPlas, CSMP, CTVS, DeltaCap, DigiSiMic, ExoCore, FilterCap, FormFit, LeaXield, MiniBlue, MiniCell, MKD, MKK, MotorCap, PCC, PhaseCap, PhaseCube, PhaseMod, PhiCap, PowerHap, PQSine, PQvar, SIFERRIT, SIFI, SIKOREL, SilverCap, SIMDAD, SiMic, SIMID, SineFormer, SIOV, ThermoFuse, WindCap are **trademarks registered or pending** in Europe and in other countries. Further information will be found on the Internet at www.epcos.com/trademarks.

Release 2018-06

Looking for pricing, stock, or lifecycle information?

Click below to explore more details on WIN SOURCE:

-  [View B32672Z4104K000 on WIN SOURCE](#)
-  [EPCOS \(TDK\) Information](#)

Optimize Your Supply Chain with WIN SOURCE Solutions

-  Global Sourcing Solution
-  Obsolete Management
-  Cost Control Management
-  Shortage Management
-  Alternative Solution
-  Excess Inventory Management