



**THE DATASHEET OF
MAX2752EUA+**



EVALUATION KIT
AVAILABLE



2.4GHz Monolithic Voltage-Controlled Oscillators

General Description

The MAX2750/MAX2751/MAX2752 are self-contained voltage-controlled oscillators (VCOs) intended for use in the 2.4GHz to 2.5GHz ISM band. Each IC combines a fully integrated oscillator and output buffer in a miniature 8-pin μ MAX package.

The inductor and varactor elements of the tank are integrated on-chip, greatly simplifying application of the part. The only required external components are a couple of supply bypass capacitors. The IC provides direct connection to the VCO tuning voltage input and the VCO buffer output. The tuning voltage input range is +0.4V to +2.4V, and the oscillator frequency tuning range is factory adjusted to provide guaranteed limits. The output signal is buffered by an amplifier stage (internally matched to 50 Ω) to provide higher output power and isolate the device from load impedance variations.

The MAX2750/MAX2751/MAX2752 operate over a +2.7V to +5.5V supply voltage range. Internal regulation of the oscillator supply voltage eliminates the need for an external LDO regulator for the VCO. The IC also provides a digitally controlled shutdown mode to permit implementation of sophisticated power-supply management. In shutdown, the supply current is reduced to less than 1 μ A.

Applications

802.11b DSSS WLAN
802.11 FHSS WLAN
Home RF
2.4GHz Bluetooth ISM Proprietary Radio

Features

- ◆ **Guaranteed Frequency Tuning Range**
MAX2750: 2400MHz to 2500MHz (Zero IF)
MAX2751: 2120MHz to 2260MHz
(240MHz to 280MHz IF)
MAX2752: 2025MHz to 2165MHz
(335MHz to 375MHz IF)
- ◆ **On-Chip Tank Circuit**
- ◆ **Internally Matched Output Buffer Amplifier**
- ◆ **Low-Current Shutdown Mode**
- ◆ **+2.7V to +5.5V Supply Voltage Range**
- ◆ **Miniature 8-Pin μ MAX Package**

Ordering Information

PART	TEMP RANGE	PIN-PACKAGE
MAX2750EUA+	-40°C to +85°C	8 μ MAX
MAX2751EUA+	-40°C to +85°C	8 μ MAX
MAX2752EUA+	-40°C to +85°C	8 μ MAX

+ Denotes a lead(Pb)-free/RoHS-compliant package. Devices are also available in a tape-and-reel packaging. Specify tape and reel by adding "T" to the part number when ordering.

Pin Configuration appears at end of data sheet.

Typical Operating Circuit

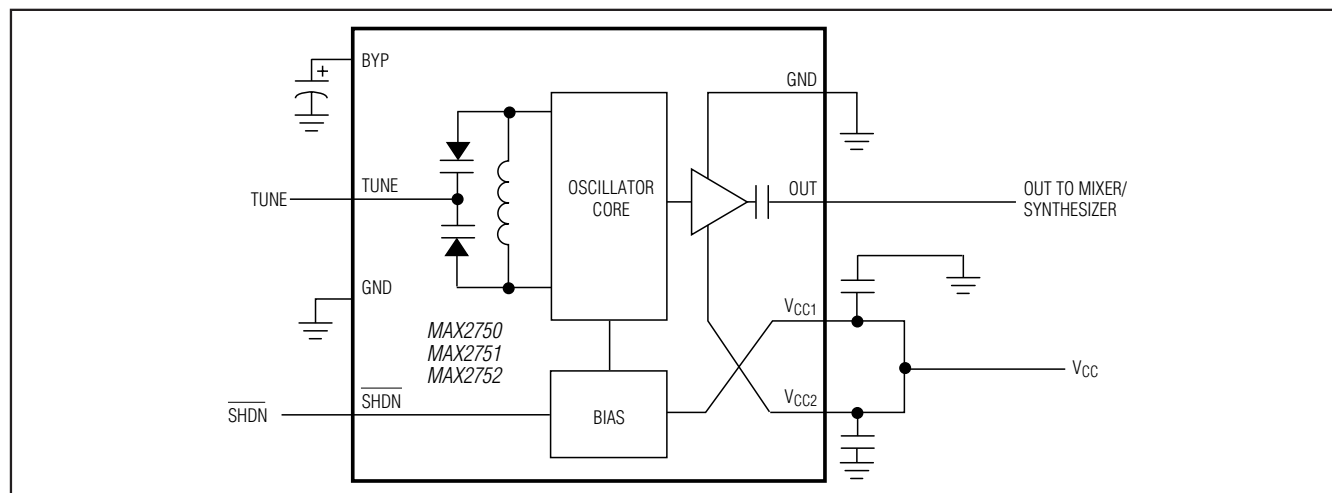

For pricing, delivery, and ordering information, please contact Maxim Direct at 1-888-629-4642, or visit Maxim's website at www.maxim-ic.com.

2.4GHz Monolithic Voltage-Controlled Oscillators

ABSOLUTE MAXIMUM RATINGS

V _{CC} to GND	-0.3V to +6V	Junction Temperature	+150°C
TUNE, $\overline{\text{SHDN}}$, BYP, OUT to GND	-0.3V to (V _{CC} + 0.3V)	Storage Temperature Range	-65°C to +150°C
Continuous Power Dissipation (T _A = +70°C)		Lead Temperature (soldering, 10s)	+300°C
μMAX (derate 4.8mW/°C above T _A = +70°C)	387.8mW	Soldering Temperature (reflow)	+260°C
Operating Temperature Range	-40°C to +85°C		

Stresses beyond those listed under "Absolute Maximum Ratings" may cause permanent damage to the device. These are stress ratings only, and functional operation of the device at these or any other conditions beyond those indicated in the operational sections of the specifications is not implied. Exposure to absolute maximum rating conditions for extended periods may affect device reliability.

DC ELECTRICAL CHARACTERISTICS

(V_{CC} = +2.7V to +5.5V, V_{TUNE} = +0.4V to +2.4V, V $\overline{\text{SHDN}}$ ≤ +2V, OUT = connected to 50Ω load, T_A = -40°C to +85°C. Typical values are at V_{CC} = +3.0V, T_A = +25°C, unless otherwise noted.) (Note 1)

PARAMETER	CONDITIONS		MIN	TYP	MAX	UNITS
Supply Voltage			2.7		5.5	V
Supply Current	MAX2750	T _A = +25°C		11.3	14.4	mA
		T _A = -40°C to +85°C		14.1	17.0	
	MAX2751	T _A = +25°C		9.7	12.1	
		T _A = -40°C to +85°C		12.7	15.9	
	MAX2752	T _A = +25°C		10	12.1	
		T _A = -40°C to +85°C		12.8	15.2	
Shutdown Supply Current				0.2	1	μA
$\overline{\text{SHDN}}$ Input Voltage Low					0.6	V
$\overline{\text{SHDN}}$ Input Voltage High			2.0			V
$\overline{\text{SHDN}}$ Input Current Low	V $\overline{\text{SHDN}}$ ≤ 0.6V		-2		2	μA
$\overline{\text{SHDN}}$ Input Current High	V $\overline{\text{SHDN}}$ ≥ 2.0V		-2		2	μA
TUNE Input Current	0.4 ≤ V _{TUNE} ≤ 2.4V			0.02		nA

AC ELECTRICAL CHARACTERISTICS

(MAX2750/MAX2751/MAX2752 EV kit, V_{CC} = +2.7V to +5.5V, V_{TUNE} = +0.4V to +2.4V, V $\overline{\text{SHDN}}$ ≤ +2V, OUT = connected to 50Ω load, T_A = +25°C. Typical values are at V_{CC} = +3.0V, unless otherwise noted.)

PARAMETER	CONDITIONS		MIN	TYP	MAX	UNITS
Oscillator Guaranteed Frequency Limits (Note 1)	V _{TUNE} = +0.4V to +2.4V, T _A = -40°C to +85°C	MAX2750	2400		2500	MHz
		MAX2751	2120		2260	MHz
		MAX2752	2025		2165	MHz
Phase Noise	f _{OFFSET} = 4MHz			-125		dBc/Hz
	Noise floor			-151		dBm/Hz
Tuning Gain (Note 2)	MAX2750	f _{OSC} = 2400MHz, +3V		140		MHz/V
		f _{OSC} = 2500MHz, +3V		90		
	MAX2751	f _{OSC} = 2120MHz, +3V		175		
		f _{OSC} = 2260MHz, +3V		110		
	MAX2752	f _{OSC} = 2025MHz, +3V		170		
		f _{OSC} = 2165MHz, +3V		105		
Output Power				-3		dBm
Return Loss				12		dB
Harmonics				-30		dBc

2.4GHz Monolithic Voltage-Controlled Oscillators

MAX2750/MAX2751/MAX2752

AC ELECTRICAL CHARACTERISTICS (continued)

(MAX2750/MAX2751/MAX2752 EV kit, $V_{CC} = +2.7V$ to $+5.5V$, $V_{TUNE} = +0.4V$ to $+2.4V$, $V_{SHDN} \leq +2V$, OUT = connected to 50Ω load, $T_A = +25^\circ C$. Typical values are at $V_{CC} = +3.0V$, unless otherwise noted.)

PARAMETER	CONDITIONS	MIN	TYP	MAX	UNITS
Load Pulling	VSWR = 2:1, all phases		4		MHzp-p
Supply Pushing	V_{CC} stepped: $+3.3V$ to $+2.8V$		1.3		MHz/V
Oscillator Turn-On Time (Note 3)	Exiting shutdown		8		μs
Oscillator Turn-Off Time (Note 4)	Entering shutdown		5		μs

Note 1: Specifications are production tested at $T_A = +25^\circ C$. Limits over temperature are guaranteed by design and characterization.

Note 2: Tuning gain is measured at the oscillator's guaranteed frequency limits.

Note 3: Turn-on time to within 3dB of final output power

Note 4: Turn-off time to output power of -10dBm.

Typical Operating Characteristics

(Circuit of Figure 1, $V_{CC} = +3.0V$, $V_{TUNE} = +0.4V$ to $+2.4V$, $V_{SHDN} \leq 2V$, $T_A = +25^\circ C$, unless otherwise noted.)

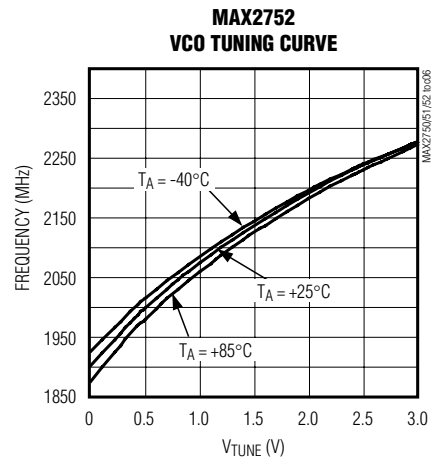
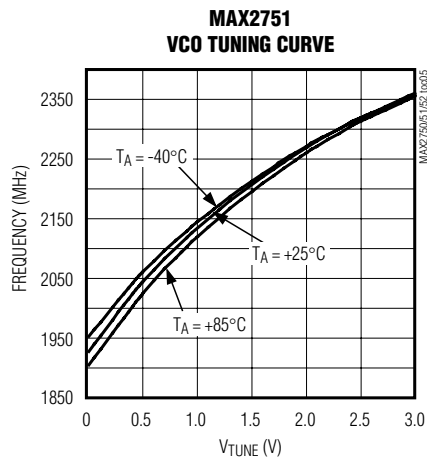
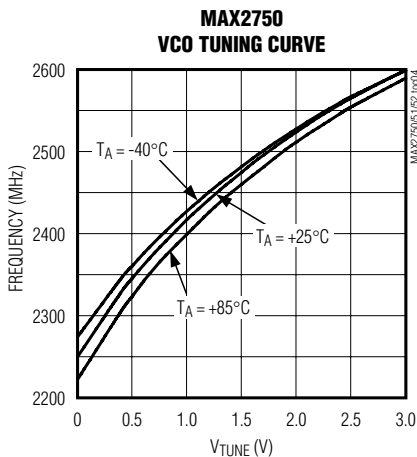
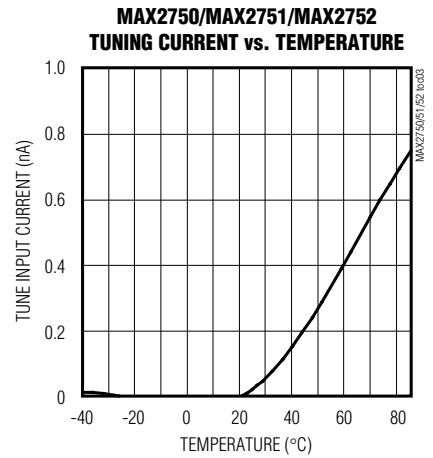
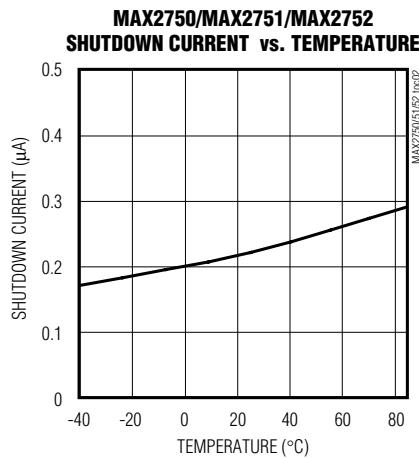
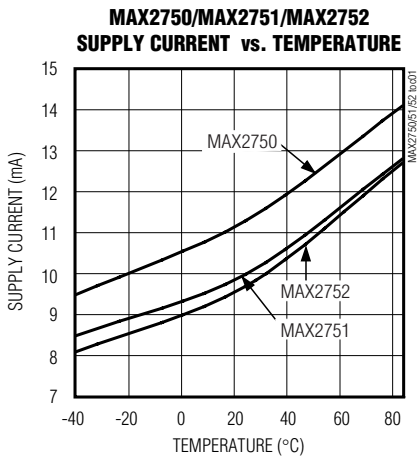

2.4GHz Monolithic Voltage-Controlled Oscillators

Typical Operating Characteristics (continued)

(Circuit of Figure 1, $V_{CC} = +3.0V$, $V_{TUNE} = +0.4V$ to $+2.4V$, $V_{SHDN} \leq 2V$, $T_A = +25^\circ C$, unless otherwise noted.)

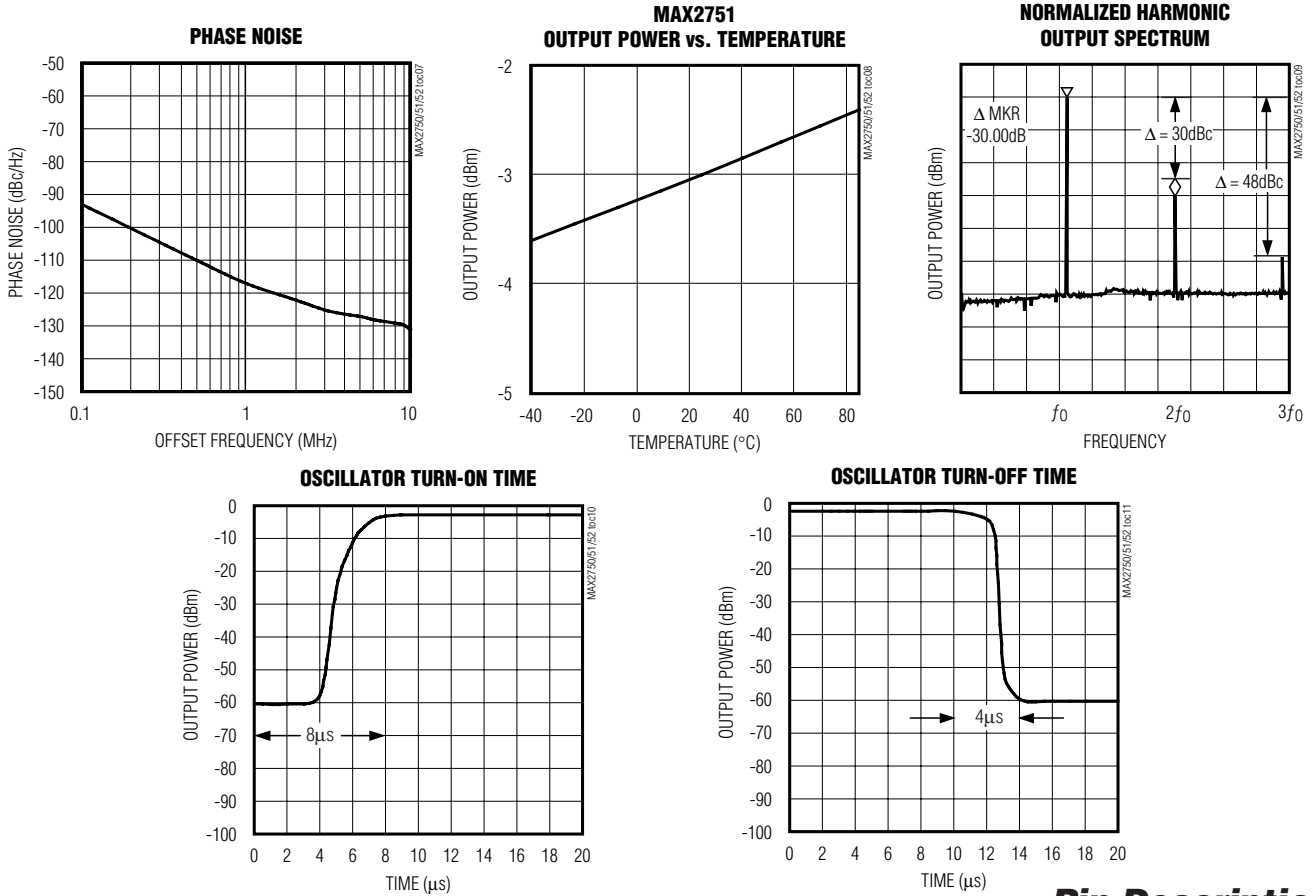

Pin Description

PIN	NAME	FUNCTION
1	BYP	VCO Bypass. Bypass with a 0.1μF capacitor to GND.
2	TUNE	Oscillator Frequency Tuning Voltage Input. High-impedance input with a voltage input range of +0.4V (low frequency) to +2.4V (high frequency).
3	GND	Ground Connection for Oscillator and Biasing. Requires a low-inductance connection to the circuit board ground plane.
4	\overline{SHDN}	Shutdown Logic Input. A high-impedance input logic level low disables the device and reduces supply current to less than 1.0μA. A logic level high enables the device.
5	V _{CC1}	Bias and Oscillator DC Supply Voltage Connection. Bypass separately from PIN6 with a 220pF capacitor to GND for low noise and low spurious content performance from the oscillator.
6	V _{CC2}	Output Buffer DC Supply Voltage Connection. Bypass separately from PIN5 with a 220pF capacitor to GND for best high frequency performance.
7	OUT	Buffered Oscillator Output. Incorporates an internal DC blocking capacitor. OUT is internally matched to 50Ω.
8	GND	Ground Connection for Output Buffer. Requires a low-inductance connection to the circuit board ground plane.

2.4GHz Monolithic Voltage-Controlled Oscillators

MAX2750/MAX2751/MAX2752

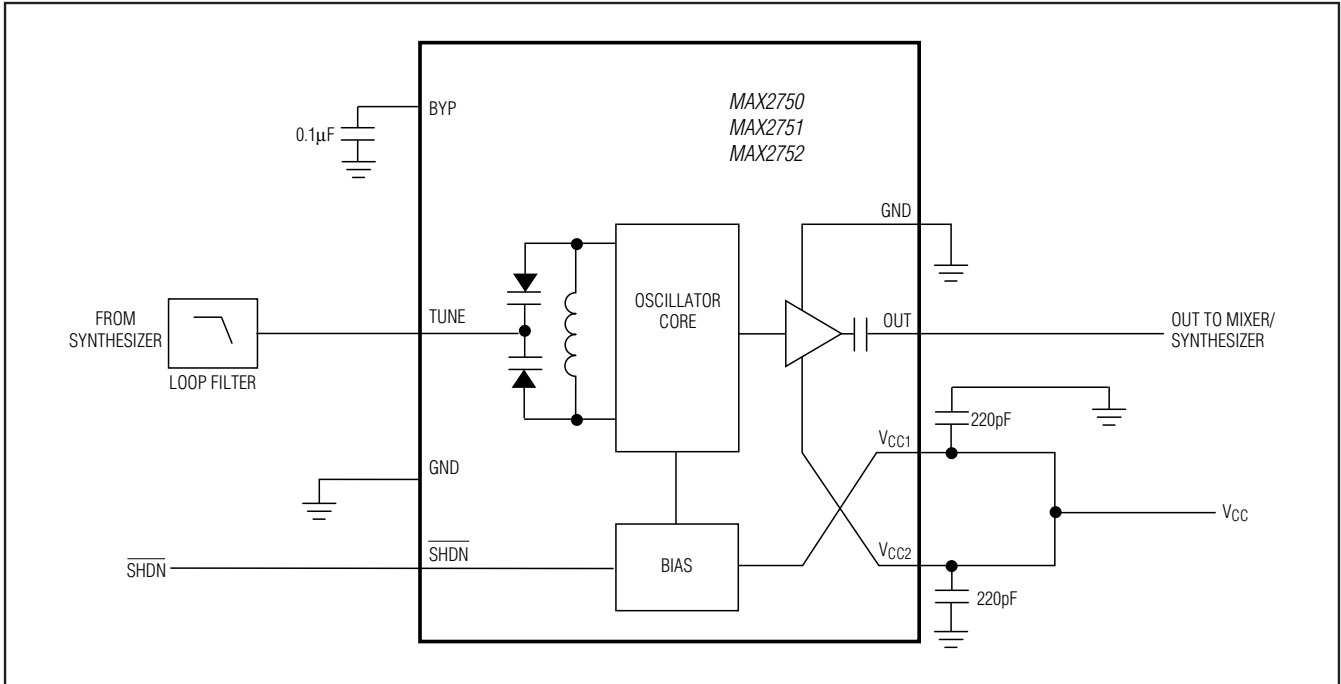

Figure 1. Typical Application Circuit

Detailed Description

Oscillator

The MAX2750/MAX2751/MAX2752 VCOs are implemented as an LC oscillator topology, integrating all of the tank components on-chip. This fully monolithic approach provides an extremely easy-to-use VCO, equivalent to a VCO module. The frequency is controlled by a voltage applied to the TUNE pin, which is internally connected to the varactor. The VCO core uses a differential topology to provide a stable frequency versus supply voltage and improve the immunity to load variations. In addition, there is a buffer amplifier following the oscillator core to provide added isolation from load variations and to boost the output power.

Output Buffer

The oscillator signal from the core drives an output buffer amplifier. The amplifier is internally matched to 50Ω including an on-chip DC blocking capacitor. No external DC blocking capacitor is required, eliminating the need for any external components. The output amplifier has its own VCC and GND pins to minimize load-pulling effects. The amplifier boosts the oscillator signal to a level suitable for driving most RF mixers.

Applications Information

Tune Input

The tuning input is typically connected to the output of the PLL loop filter. The loop filter provides an appropriately low-impedance source. The input may incorporate an extra RC filter stage to reduce high-frequency noise and spurious signals. Any excess noise on the tuning input is directly translated into FM noise, which can degrade the phase-noise performance of the oscillator. Therefore, it is important to minimize the noise introduced on the tuning input. A simple RC filter with low corner frequency is needed during testing in order to filter the noise present on the voltage source driving the tuning line.

Layout Issues

Always use controlled impedance lines (microstrip, coplanar waveguide, etc.) for high-frequency signals. Always place decoupling capacitors as close to the VCC pins as possible; for long VCC lines, it may be necessary to add additional decoupling capacitors located further from the device. Always provide a low-inductance path to ground, and keep GND vias as close to the device as possible. Thermal reliefs on GND pads are not recommended.

2.4GHz Monolithic Voltage-Controlled Oscillators

Pin Configuration

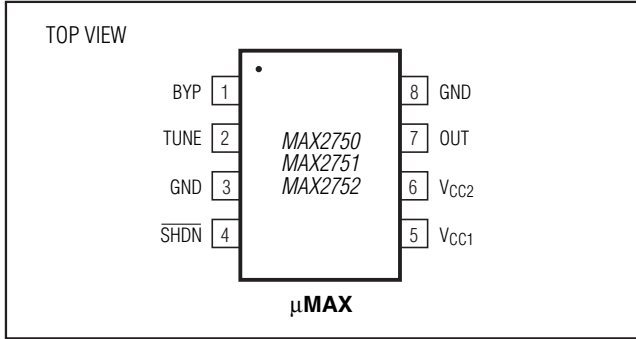

Chip Information

PROCESS: BiPOLAR

Package Information

For the latest package outline information and land patterns (footprints), go to www.maxim-ic.com/packages. Note that a "+", "#", or "-" in the package code indicates RoHS status only. Package drawings may show a different suffix character, but the drawing pertains to the package regardless of RoHS status.

PACKAGE TYPE	PACKAGE CODE	OUTLINE NO.	LAND PATTERN NO.
8 μMAX	U8+1	21-0036	90-0092

2.4GHz Monolithic Voltage-Controlled Oscillators

Revision History

REVISION NUMBER	REVISION DATE	DESCRIPTION	PAGES CHANGED
0	10/00	Initial release	—
1	5/12	Added information for lead-free compliant options, added <i>Absolute Maximum Ratings</i> information, updated TOC 11	1, 2, 4

MAX2750/MAX2751/MAX2752

Maxim cannot assume responsibility for use of any circuitry other than circuitry entirely embodied in a Maxim product. No circuit patent licenses are implied. Maxim reserves the right to change the circuitry and specifications without notice at any time. The parametric values (min and max limits) shown in the Electrical Characteristics table are guaranteed. Other parametric values quoted in this data sheet are provided for guidance.

Maxim Integrated Products, 160 Rio Robles, San Jose, CA 95134 USA 1-408-601-1000 _____ 7

Looking for pricing, stock, or lifecycle information?

Click below to explore more details on WIN SOURCE:

 [View MAX2752EUA+](#) on WIN SOURCE

 [Maxim Integrated](#) Information

Optimize Your Supply Chain with WIN SOURCE Solutions

-  Global Sourcing Solution
-  Obsolete Management
-  Cost Control Management
-  Shortage Management
-  Alternative Solution
-  Excess Inventory Management