



Film Capacitors

Metallized Polypropylene Film Capacitors (MKP)

Series/Type: B32613, B32614

Date: September 2018

© EPCOS AG 2018. Reproduction, publication and dissemination of this publication, enclosures hereto and the information contained therein without EPCOS' prior express consent is prohibited.

EPCOS AG is a TDK Group Company.

High pulse (wound)**Typical applications**

- Electronic ballasts
- Switch-mode power supplies

Climatic

- Max. operating temperature: 110 °C
- Climatic category (IEC 60068-1:2013): 55/100/56

Construction

- Dielectric: polypropylene (PP)
- Wound capacitor technology
- Epoxy resin coating (UL 94 V-0)

Features

- Very high pulse strength
- RoHS-compatible

Terminals

- Crimped wire leads, lead-free tinned, lead length (6 – 1) mm
- Double crimped wire leads, lead-free tinned
- Straight wire leads, lead-free tinned, lead length (17 ±3) mm
- Different lead spacings (reduced and enlarged) available, lead length (6 – 1) mm

Marking

Manufacturer's logo, style and type (P61x),
rated capacitance (coded),
capacitance tolerance (code letter),
rated DC voltage, date of manufacture (code)

Delivery mode

Bulk (untaped)

Taped (Ammo pack or reel)

For notes on taping, refer to chapter "Taping and packing".



Dimensional drawings

Crimped leads

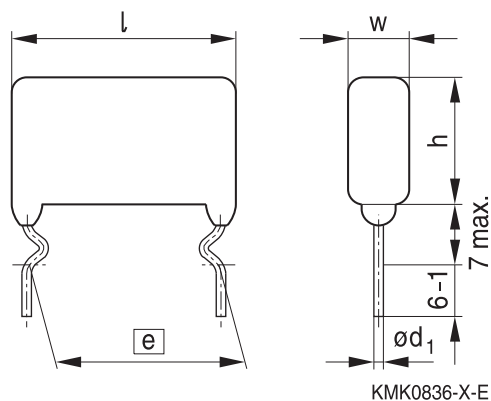

Double crimped leads

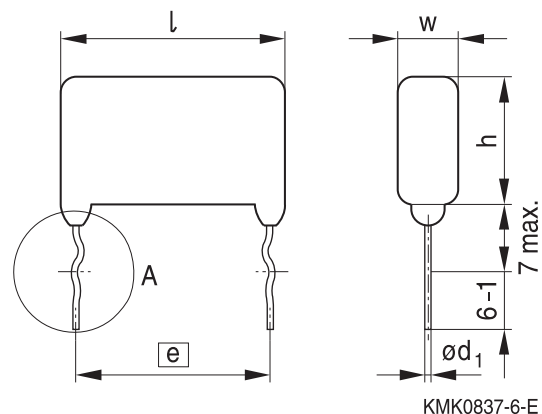

Detail of double crimped version

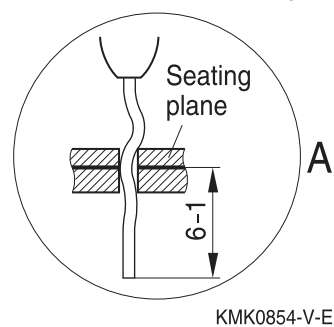

Straight leads

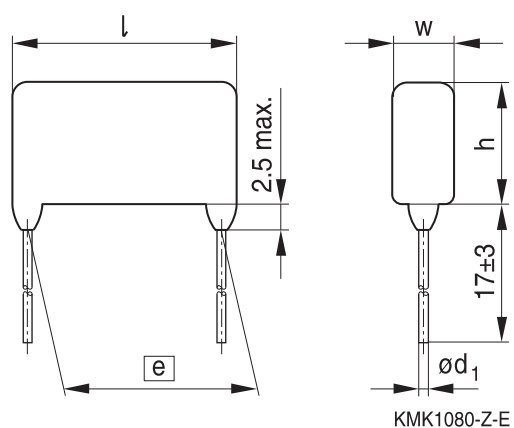

Dimensions in mm

Lead spacing	Lead diameter	Type
$e \pm 0.8$	$d_1 \pm 0.05$	
22.5	0.8	B32613
27.5	0.8	B32614



B32613, B32614

High pulse (wound)

Overview of available types

Lead spacing	22.5 mm						
Type	B32613						
Page	6						
V_R (V DC)	250	400	630	1000	1600	2000	2000
V_{RMS} (V AC)	160	200	250	250	500	700	1000
C_R (nF)							
3.3							
4.7							
6.8							
10							
15							
22							
33							
47							
68							
100							
150							
220							
330							
470							
680							
1000							

Lead configurations

Serie	Standard	Reduced	Enlarged	Straight	Double crimped
B32613	22.5 mm	15 / 17.5 / 20 mm	25 mm	22.5 mm	22.5 mm
B32614	27.5 mm	25 mm	—	27.5 mm	27.5 mm

Overview of available types

Lead spacing	27.5 mm					
Type	B32614					
Page	8					
V_R (V DC)	250	400	630	1000	1600	2000
V_{RMS} (V AC)	160	200	250	250	500	700
C_R (nF)						
10						
15						
22						
33						
47						
68						
100						
150						
220						
470						
680						
1000						
1500						
2200						

Lead configurations

Serie	Standard	Reduced	Enlarged	Straight	Double crimped
B32613	22.5 mm	15 / 17.5 / 20 mm	25 mm	22.5 mm	22.5 mm
B32614	27.5 mm	25 mm	–	27.5 mm	27.5 mm

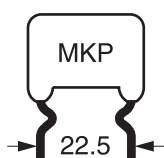
B32613
High pulse (wound)
Ordering codes and packing units (lead spacing 22.5 mm)

V_R	V_{RMS} $f \leq 1$ kHz	C_R	Max. dimensions $w \times h \times l$ mm	Ordering code (composition see below)	Ammo pack pcs./MOQ	Reel pcs./MOQ	Untaped pcs./MOQ
V DC	V AC	nF					
250	160	220	7.0 × 14.5 × 26.5	B32613A3224+***	2000	2800	2000
		330	7.0 × 14.5 × 26.5	B32613A3334+***	2000	2800	2000
		470	8.0 × 15.5 × 26.5	B32613A3474+***	1800	2400	2000
		680	9.5 × 16.0 × 26.5	B32613A3684+***	1400	2000	2000
		1000	11.0 × 19.0 × 26.5	B32613A3105+***	1200	1800	1000
400	200	150	7.0 × 13.5 × 26.5	B32613A4154+***	2000	2800	2000
		220	7.0 × 14.0 × 26.5	B32613A4224+***	2000	2800	2000
		330	8.0 × 16.0 × 26.5	B32613A4334+***	1800	2400	2000
		470	9.5 × 16.0 × 26.5	B32613A4474+***	1400	2000	1000
		680	11.5 × 17.5 × 26.5	B32613A4684+***	1200	1600	1000
630	250	100	7.0 × 12.5 × 26.5	B32613A6104+***	2000	2800	1000
		150	7.5 × 14.0 × 26.5	B32613A6154+***	1800	2600	1000
		220	9.0 × 15.5 × 26.5	B32613A6224+***	1600	2200	1000
		330	10.0 × 18.0 × 26.5	B32613A6334+***	1400	2000	1000
		470	11.0 × 20.0 × 26.5	B32613A6474+***	1200	1800	1000
1000	250	33	8.5 × 14.5 × 26.5	B32613A0333+***	1600	2200	2000
		47	10.0 × 15.5 × 26.5	B32613A0473+***	1400	2000	1000
		68	11.0 × 17.5 × 26.5	B32613A0683+***	1200	1800	1000
		100	10.0 × 16.5 × 26.5	B32613A0104+***	1400	2000	1000
		150	12.0 × 18.0 × 26.5	B32613A0154+***	1200	1600	1000
1600	500	10	7.0 × 13.5 × 26.5	B32613A1103+***	2000	2800	2000
		15	8.0 × 14.5 × 26.5	B32613A1153+***	1800	2400	2000
		22	9.0 × 17.0 × 26.5	B32613A1223+***	1600	2200	1000
		33	10.5 × 18.5 × 26.5	B32613A1333+***	1400	1800	1000

MOQ = Minimum Order Quantity, consisting of 4 packing units.
Further E series and intermediate capacitance values on request.

Composition of ordering code

+ = Capacitance tolerance code:

K = ±10%

J = ±5%

*** = Packaging code:

289 = Ammo pack

189 = Reel

010 = Untaped crimped (lead length 6 – 1 mm)

008 = Untaped straight (lead length 17±3 mm)

020 = Double crimped (lead length 6 – 1 mm)

Packaging codes for further lead configurations (untaped):

Lead configuration (lead length 6 – 1 mm)	Reduced	Reduced	Reduced	Enlarged
Lead spacing (mm)	15 mm	17.5 mm	20 mm	25 mm
Packaging code	055	060	070	080

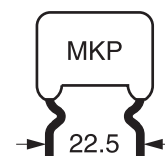
Ordering codes and packing units (lead spacing 22.5 mm)

V_R	V_{RMS} $f \leq 1$ kHz	C_R	Max. dimensions $w \times h \times l$ mm	Ordering code (composition see below)	Ammo pack pcs./MOQ	Reel pcs./MOQ	Untaped pcs./MOQ
V DC	V AC	nF					
2000	700	3.3	7.0 × 13.0 × 26.5	B32613A2332+***	2000	2800	2000
		4.7	7.5 × 14.0 × 26.5	B32613A2472+***	1800	2600	2000
		6.8	8.5 × 16.0 × 26.5	B32613A2682+***	1600	2200	2000
		10	10.5 × 17.0 × 26.5	B32613A2103+***	1400	1800	1000
		15	12.0 × 20.5 × 26.5	B32613A2153+***	1200	1600	1000
2000	1000	3.3	8.0 × 14.5 × 26.5	B32613A8332+***	1800	2400	2000
		4.7	8.5 × 16.5 × 26.5	B32613A8472+***	1600	2200	1000
		6.8	10.0 × 18.5 × 26.5	B32613A8682+***	1400	2000	1000
		10	11.5 × 21.5 × 26.5	B32613A8103+***	1200	1600	1000

MOQ = Minimum Order Quantity, consisting of 4 packing units.
Further E series and intermediate capacitance values on request.

Composition of ordering code

+ = Capacitance tolerance code:

K = ±10%

J = ±5%

*** = Packaging code:

289 = Ammo pack

189 = Reel

010 = Untaped crimped (lead length 6 – 1 mm)

008 = Untaped straight (lead length 17±3 mm)

020 = Double crimped (lead length 6 – 1 mm)

Packaging codes for further lead configurations (untaped):

Lead configuration (lead length 6 – 1 mm)	Reduced	Reduced	Reduced	Enlarged
Lead spacing (mm)	15 mm	17.5 mm	20 mm	25 mm
Packaging code	055	060	070	080

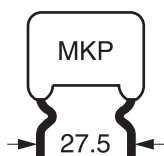

B32614

High pulse (wound)

Ordering codes and packing units (lead spacing 27.5 mm)

V_R	V_{RMS} $f \leq 1$ kHz	C_R	Max. dimensions $w \times h \times l$ mm	Ordering code (composition see below)	Untaped pcs./MOQ
V DC	V AC	nF			
250	160	470	7.0 × 15.0 × 31.5	B32614A3474+***	2000
		680	8.0 × 16.5 × 31.5	B32614A3684+***	2000
		1000	9.5 × 17.5 × 31.5	B32614A3105+***	800
		1500	11.5 × 19.5 × 31.5	B32614A3155+***	800
		2200	14.0 × 22.0 × 31.5	B32614A3225+***	800
400	200	470	9.5 × 15.0 × 31.5	B32614A4474+***	800
		680	10.0 × 17.5 × 31.5	B32614A4684+***	800
		1000	11.5 × 19.5 × 31.5	B32614A4105+***	800
		1500	14.0 × 22.0 × 31.5	B32614A4155+***	800
		2200	16.5 × 24.5 × 31.5	B32614A4225+***	600
630	250	470	10.5 × 18.5 × 31.5	B32614A6474+***	800
		680	12.0 × 21.5 × 31.5	B32614A6684+***	800
		1000	14.0 × 24.0 × 31.5	B32614A6105+***	800
1000	250	100	11.5 × 17.5 × 31.5	B32614A0104+***	2000
		150	13.0 × 21.0 × 31.5	B32614A0154+***	800
		220	14.5 × 24.5 × 31.5	B32614A0224+***	800
1600	500	22	9.0 × 14.5 × 31.5	B32614A1223+***	2000
		33	10.5 × 16.0 × 31.5	B32614A1333+***	2000
		47	11.0 × 19.5 × 31.5	B32614A1473+***	800
		68	13.0 × 21.5 × 31.5	B32614A1683+***	800
2000	700	10	9.0 × 15.5 × 31.5	B32614A2103+***	2000
		15	11.0 × 17.5 × 31.5	B32614A2153+***	800
		22	13.0 × 19.5 × 31.5	B32614A2223+***	800
		33	14.5 × 23.0 × 31.5	B32614A2333+***	800
		47	16.5 × 25.5 × 31.5	B32614A2473+***	600

MOQ = Minimum Order Quantity, consisting of 4 packing units.
Further E series and intermediate capacitance values on request.

Composition of ordering code

+ = Capacitance tolerance code:

K = ±10%

J = ±5%

*** = Packaging code:

010 = Untaped crimped (lead length 6 – 1 mm)

008 = Untaped straight (lead length 17±3 mm)

020 = Double crimped (lead length 6 – 1 mm)

Packaging codes for further lead configurations (untaped):

Lead configuration (lead length 6 – 1 mm)	Reduced
Lead spacing (mm)	25 mm
Packaging code	090

Technical data

 Reference standard: IEC 60384-16:2005. All data given at $T = 20\text{ }^{\circ}\text{C}$, unless otherwise specified.

Operating temperature range	Max. operating temperature $T_{op,max}$			+110 °C
	Upper category temperature T_{max}			+100 °C
	Lower category temperature T_{min}			-55 °C
	Rated temperature T_R			+85 °C
Dissipation factor $\tan \delta$ (in 10^{-3}) at 20 °C (upper limit values)	at	$C_R \leq 0.1\text{ }\mu\text{F}$	$0.1\text{ }\mu\text{F} < C_R \leq 1\text{ }\mu\text{F}$	$C_R > 1\text{ }\mu\text{F}$
	1 kHz	—	0.5	0.5
	10 kHz	—	0.8	1.5
	100 kHz	5.0	—	—
Insulation resistance R_{ins} or time constant $\tau = C_R \cdot R_{ins}$ at 20 °C, rel. humidity $\leq 65\%$ (minimum as-delivered values)	$C_R \leq 0.33\text{ }\mu\text{F}$		$C_R > 0.33\text{ }\mu\text{F}$	
	100 G Ω		30000 s	
DC test voltage	$1.6 \cdot V_R$, 2 s			
Category voltage V_C (continuous operation with V_{DC} or V_{AC} at $f \leq 1\text{ kHz}$)	T_{op} (°C)	DC voltage derating		AC voltage derating
	$T_{op} \leq 85$	$V_C = V_R$		$V_{C,RMS} = V_{RMS}$
	$85 < T_{op} \leq 100$	$V_C = V_R \cdot (165 - T_{op})/80$		$V_{C,RMS} = V_{RMS} \cdot (165 - T_{op})/80$
Operating voltage V_{op} for short operating periods (V_{DC} or V_{AC} at $f \leq 1\text{ kHz}$)	T_{op} (°C)	DC voltage (max. hours)		AC voltage (max. hours)
	$T_{op} \leq 100$	$V_{op} = 1.25 \cdot V_C$ (2000 h)		$V_{op} = 1.0 \cdot V_{C,RMS}$ (2000 h)
	$100 < T_{op} \leq 110$	$V_{op} = 1.25 \cdot V_C$ (1000 h)		$V_{op} = 1.0 \cdot V_{C,RMS}$ (1000 h)
Reliability: Failure rate λ Service life t_{SL}	1 fit ($\leq 1 \cdot 10^{-9}$ /h) at $0.5 \cdot V_R$, 40 °C 200 000 h at $1.0 \cdot V_R$, 85 °C For conversion to other operating conditions and temperatures, refer to chapter "Quality, 2 Reliability".			
Failure criteria: Total failure Failure due to variation of parameters	Short circuit or open circuit Capacitance change $ \Delta C/C $ > 10% Dissipation factor $\tan \delta$ > 4 · upper limit value Insulation resistance R_{ins} < 1500 M Ω ($C_R \leq 0.33\text{ }\mu\text{F}$) or time constant $\tau = C_R \cdot R_{ins}$ < 500 s ($C_R > 0.33\text{ }\mu\text{F}$)			

Characteristic voltages V_{DC} , V_{AC} , V_{pp}

V_{DC} V	V_{AC} V	V_{pp} V
1000	250	700
1250	500	1250
1600	500	1400
1600	700	1600
2000	700	1600
2000	1000	2000



B32613, B32614

High pulse (wound)

Pulse handling capability

"dV/dt" represents the maximum permissible voltage change per unit of time for non-sinusoidal voltages, expressed in V/ μ s.

"k₀" represents the maximum permissible pulse characteristic of the waveform applied to the capacitor, expressed in V²/ μ s.

Note:

The values of dV/dt and k₀ provided below must not be exceeded in order to avoid damaging the capacitor. These parameters are given for isolated pulses in such a way that the heat generated by one pulse will be completely dissipated before applying the next pulse. For a train of pulses, please refer to the curves of permissible AC voltage-current versus frequency.

dV/dt values

Lead spacing		22.5 mm	27.5 mm
V _R V DC	V _{RMS} V AC	dV/dt in V/ μ s	
250	160	120	50
400	200	180	100
630	250	300	150
1000	250	600	300
1250	500	1150	600
1600	500	2400	1000
1600	700	–	–
2000	700	7000	2300
2000	1000	7500	–

k₀ values

Lead spacing		22.5 mm	27.5 mm
V _R V DC	V _{RMS} V AC	k ₀ in V ² / μ s	
250	160	60 000	25 000
400	200	200 000	110 000
630	250	350 000	250 000
1000	250	1 500 000	1 000 000
1250	500	3 750 000	2 000 000
1600	500	10 000 000	4 000 000
1600	700	–	–
2000	700	40 000 000	15 000 000
2000	1000	50 000 000	–

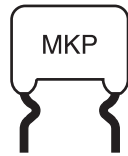

Impedance Z versus frequency f
(typical values)

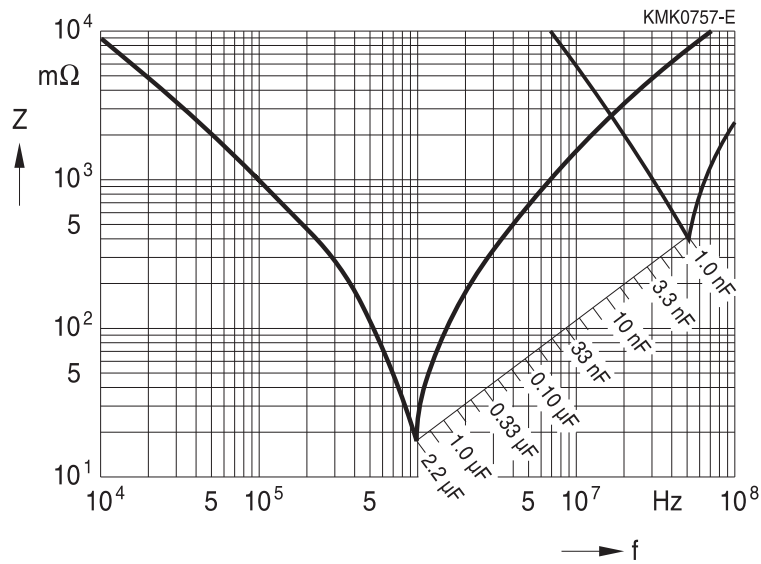

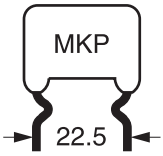

B32613

High pulse (wound)

Permissible AC voltage V_{RMS} versus frequency f (for sinusoidal waveforms, $T_A \leq 90^\circ C$)

For $T_A > 90^\circ C$, please use derating factor F_T .

Lead spacing 22.5 mm

250 V DC/160 V AC

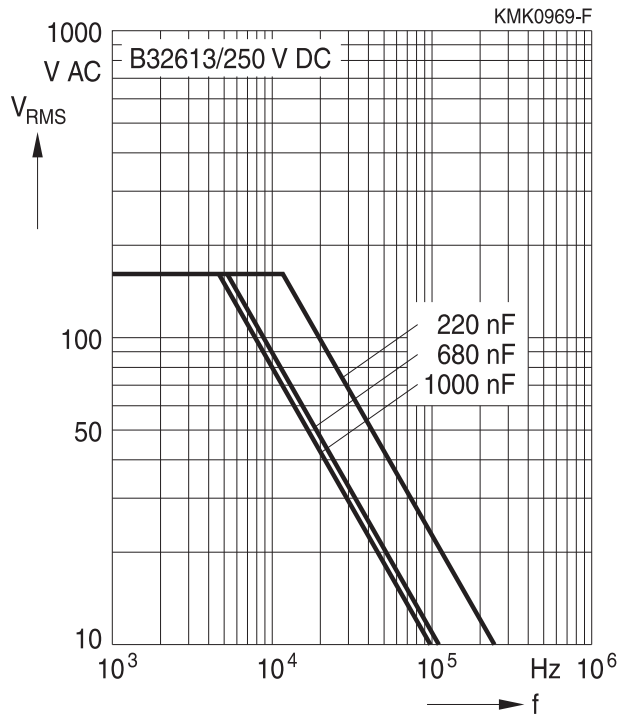

400 V DC/200 V AC

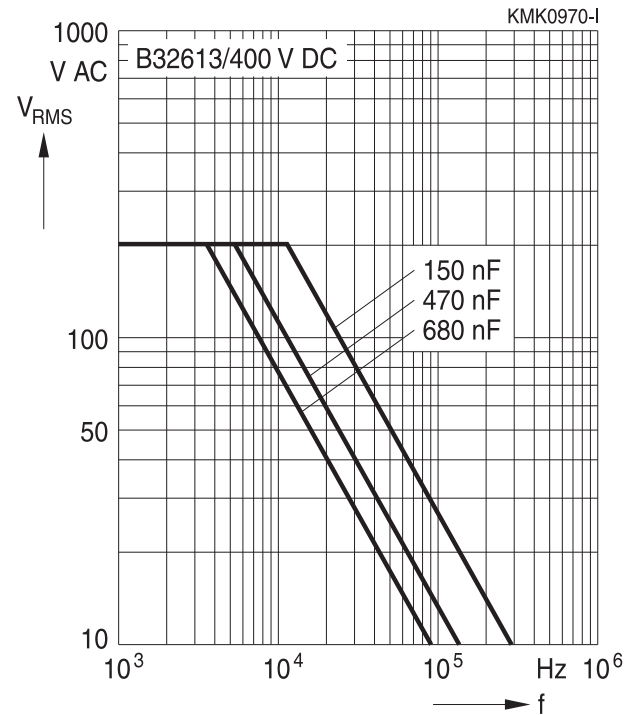

630 V DC/250 V AC

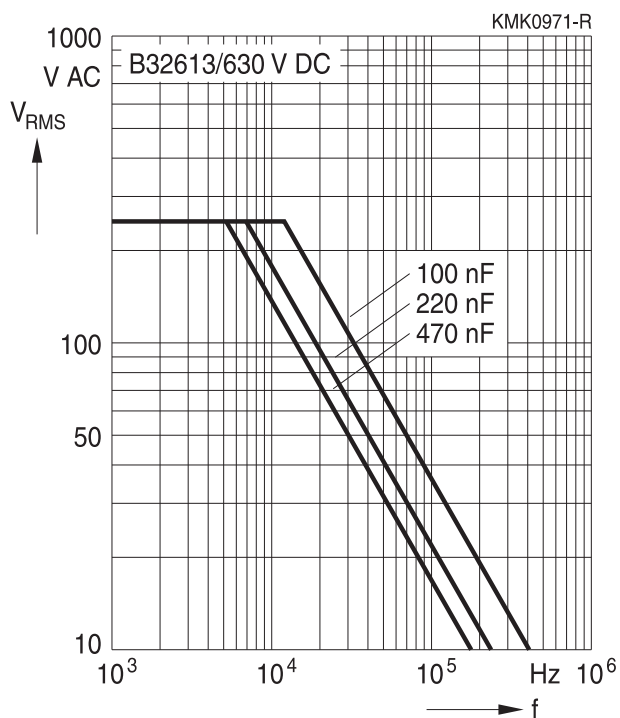

1000 V DC/250 V AC

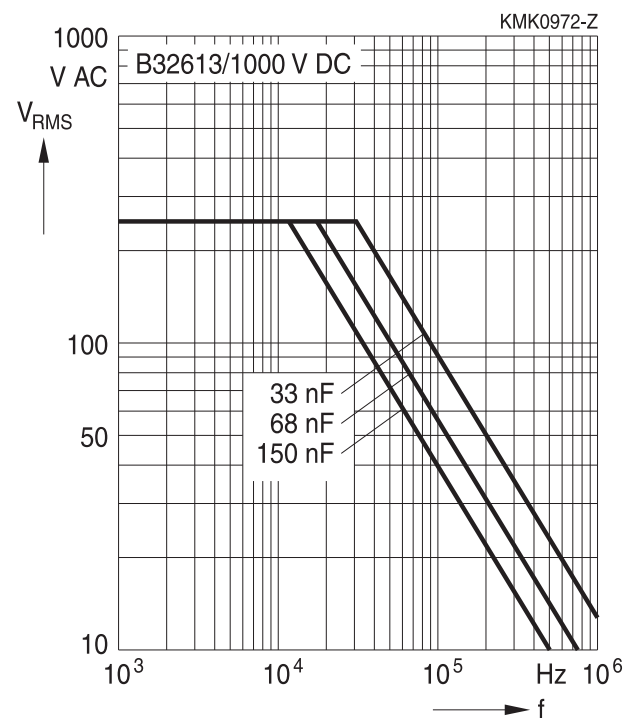

B32613

High pulse (wound)

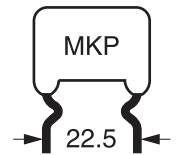

Permissible AC voltage V_{RMS} versus frequency f (for sinusoidal waveforms, $T_A \leq 90^\circ C$)

For $T_A > 90^\circ C$, please use derating factor F_T .

Lead spacing 22.5 mm

1600 V DC/500 V AC

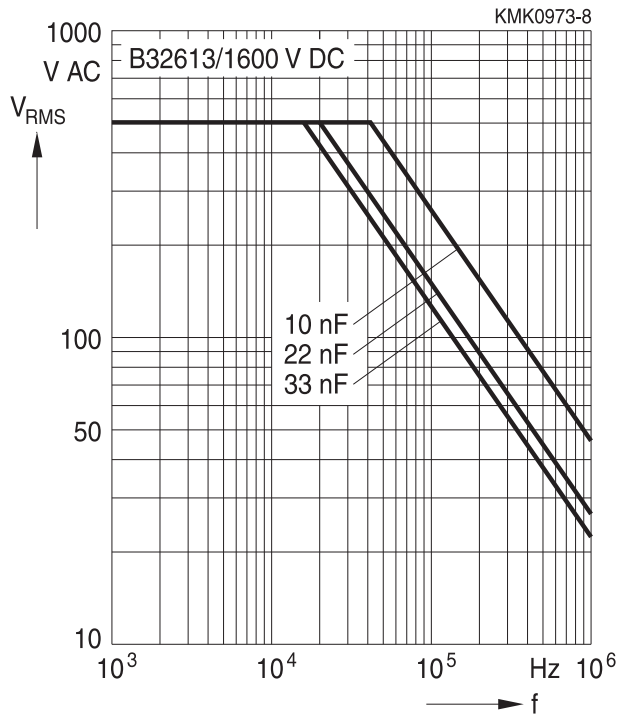

2000 V DC/700 V AC

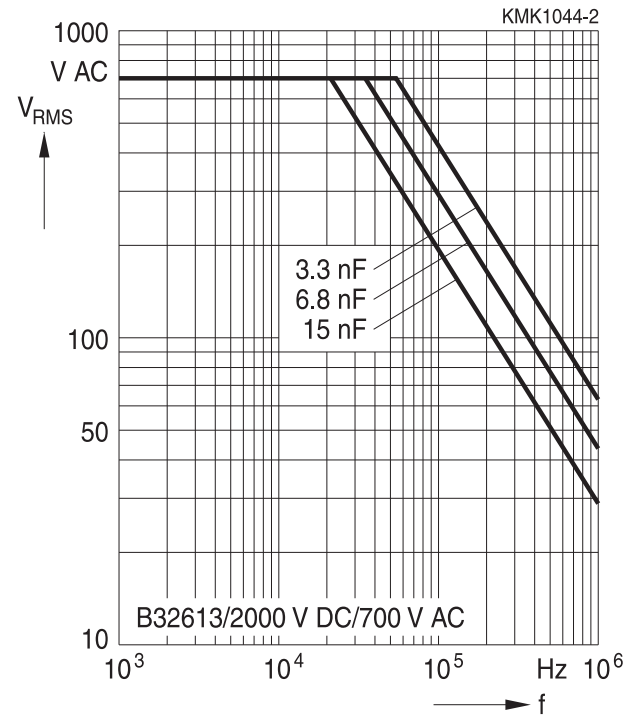

2000 V DC/1000 V AC

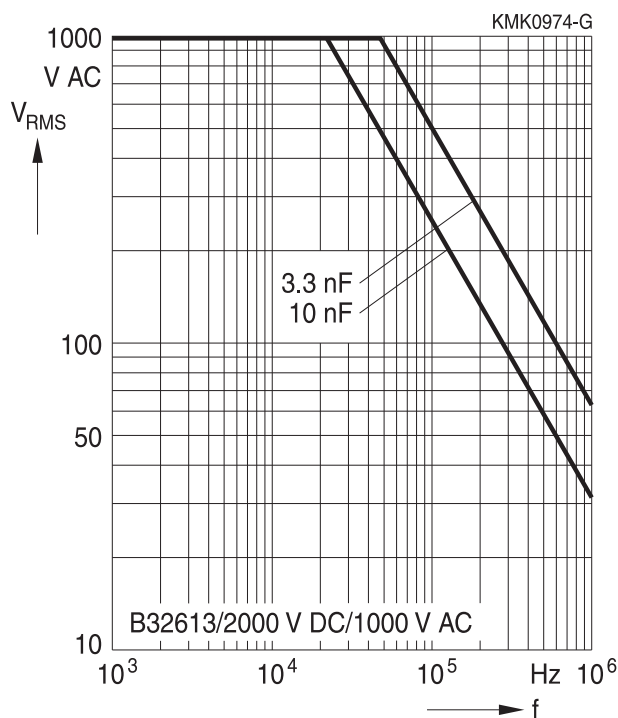

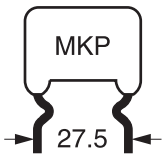

B32614

High pulse (wound)

Permissible AC voltage V_{RMS} versus frequency f (for sinusoidal waveforms, $T_A \leq 90^\circ C$)

For $T_A > 90^\circ C$, please use derating factor F_T .

Lead spacing 27.5 mm

250 V DC/160 V AC

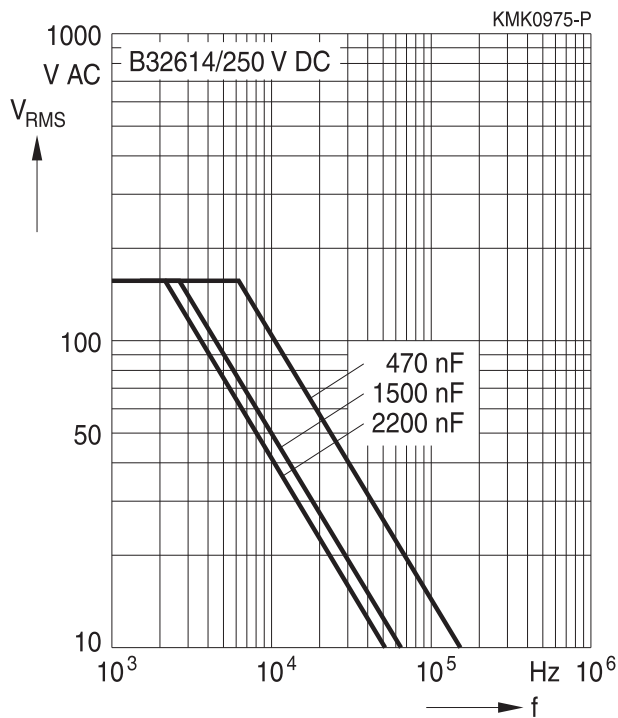

400 V DC/200 V AC

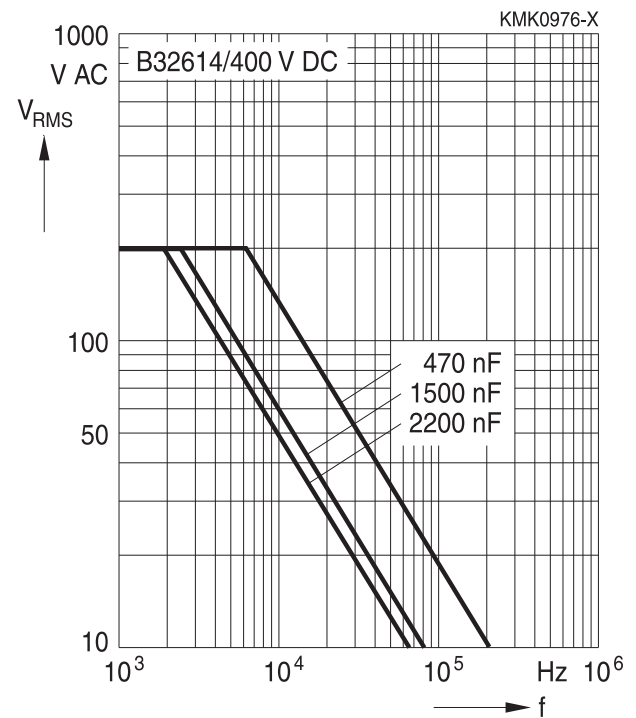

630 V DC/250 V AC

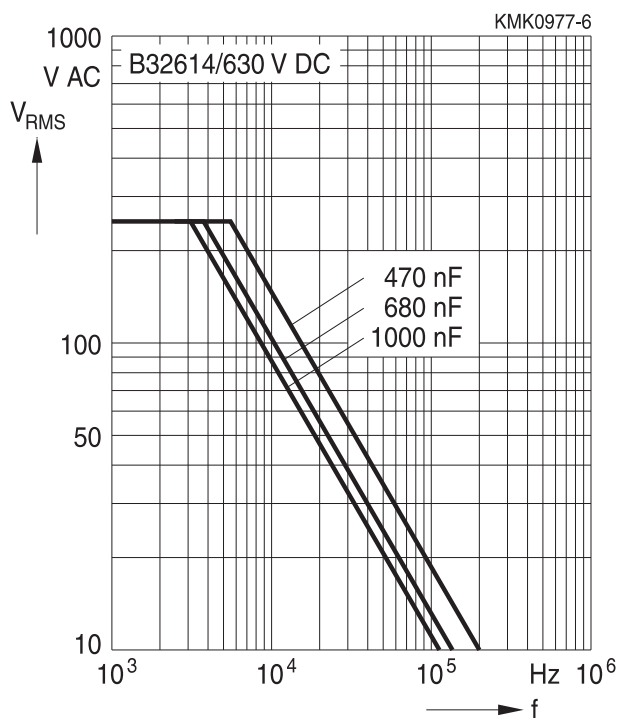

1000 V DC/250 V AC

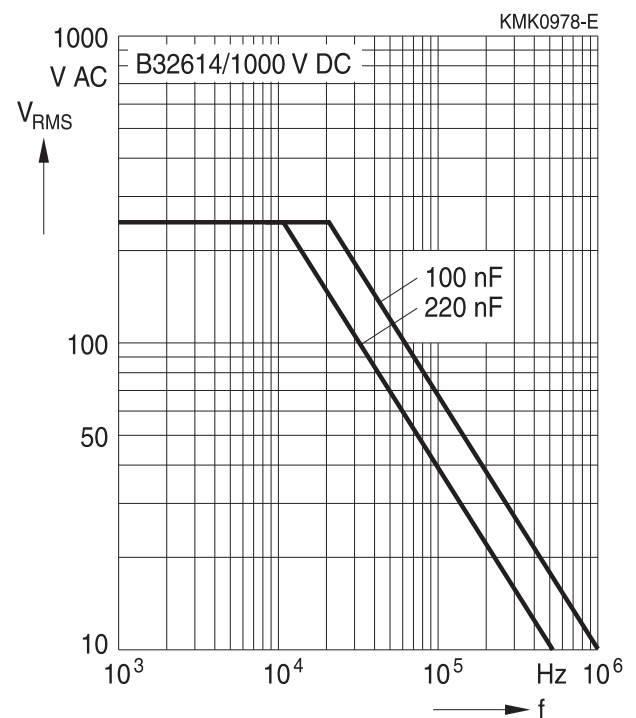

B32614

High pulse (wound)

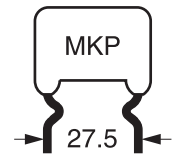

Permissible AC voltage V_{RMS} versus frequency f (for sinusoidal waveforms, $T_A \leq 90^\circ C$)

For $T_A > 90^\circ C$, please use derating factor F_T .

Lead spacing 27.5 mm

1600 V DC/500 V AC

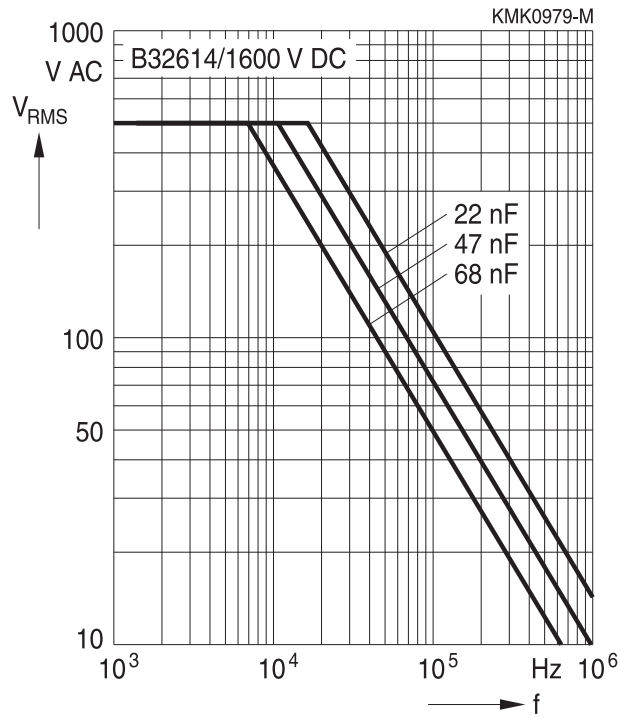

2000 V DC/700 V AC

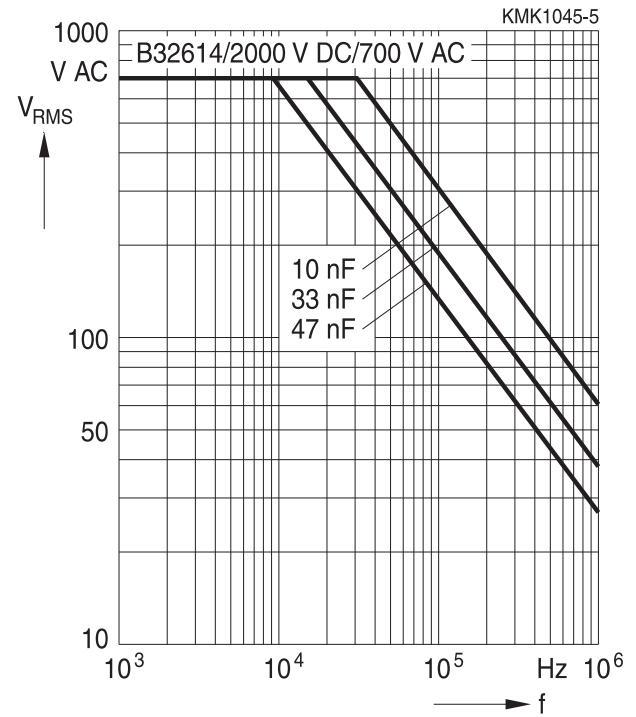



B32613, B32614

High pulse (wound)

Maximum AC voltage (V_{RMS}), current (I_{RMS}) versus frequency and temperature for $T_A > 90\text{ }^\circ\text{C}$

The graphs described in the previous section for the permissible AC voltage (V_{RMS}) or current (I_{RMS}) versus frequency are given for a maximum ambient temperature $T_A \leq 90\text{ }^\circ\text{C}$. In case of higher ambient temperatures (T_A), the self-heating (ΔT) of the component must be reduced to avoid that temperature of the component ($T_{op} = T_A + \Delta T$) reaches values above maximum operating temperature. The factor F_T shall be applied in the following way:

$$I_{RMS}(T_A) = I_{RMS, T_A \leq 90\text{ }^\circ\text{C}} \cdot F_T(T_A)$$

$$V_{RMS}(T_A) = V_{RMS, T_A \leq 90\text{ }^\circ\text{C}} \cdot F_T(T_A)$$

And F_T is given by the following curve:

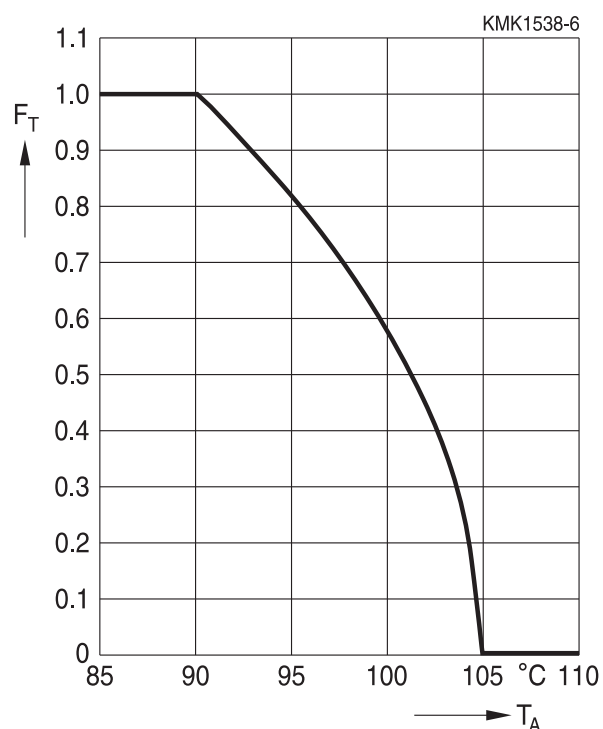

Testing and Standards

Test	Reference	Conditions of test	Performance requirements
Electrical parameters	IEC 60384-16:2005	Voltage proof, $1.6 V_R$, 1 minute Insulation resistance, R_{ins} Capacitance, C Dissipation factor, $\tan \delta$	Within specified limits
Robustness of terminations	IEC 60068-2-21:2006	Tensile strength (test Ua1) Wire diameter Tensile force $0.5 < d_1 \leq 0.8 \text{ mm}$ 10 N	Capacitance and $\tan \delta$ within specified limits
Resistance to soldering heat	IEC 60068-2-20:2008, test Tb, method 1A	Solder bath temperature at $260 \pm 5 \text{ }^\circ\text{C}$, immersion for 10 seconds	$\Delta C/C_0 \leq 2\%$ $ \Delta \tan \delta \leq 0.002$
Rapid change of temperature	IEC 60384-16:2005	T_A = lower category temperature T_B = upper category temperature Five cycles, duration $t = 30 \text{ min.}$	$ \Delta C/C_0 \leq 2\%$ $ \Delta \tan \delta \leq 0.002$ $R_{ins} \geq 50\%$ of initial limit
Vibration	IEC 60384-16:2005	Test F_C : vibration sinusoidal Displacement: 0.75 mm Acceleration: 98 m/s^2 Frequency: 10 Hz ... 500 Hz Test duration: 3 orthogonal axes, 2 hours each axe	No visible damage
Bump	IEC 60384-16:2005	Test Eb: Total 4000 bumps with 390 m/s^2 mounted on PCB Duration: 6 ms	No visible damage $ \Delta C/C_0 \leq 2\%$ $ \Delta \tan \delta \leq 0.002$ $R_{ins} \geq 50\%$ of initial limit
Climatic sequence	IEC 60384-16:2005	Dry heat Tb / 16 h Damp heat cyclic, 1 st cycle $+55 \text{ }^\circ\text{C} / 24 \text{ h} / 95\% \dots 100\% \text{ RH}$ Cold Ta / 2 h Damp heat cyclic, 5 cycles $+55 \text{ }^\circ\text{C} / 24 \text{ h} / 95\% \dots 100\% \text{ RH}$	No visible damage $ \Delta C/C_0 \leq 3\%$ $ \Delta \tan \delta \leq 0.001$ $R_{ins} \geq 50\%$ of initial limit
Damp heat, steady state	IEC 60384-16:2005	Test Ca $40 \text{ }^\circ\text{C} / 93\% \text{ RH} / 56 \text{ days}$	No visible damage $ \Delta C/C_0 \leq 3\%$ $ \Delta \tan \delta \leq 0.001$ $R_{ins} \geq 50\%$ of initial limit
Endurance A	IEC 60384-16:2005	$85 \text{ }^\circ\text{C} / 1.25 V_R / 2000 \text{ hours}$	No visible damage $ \Delta C/C_0 \leq 5\%$ $ \Delta \tan \delta \leq 0.002$ $R_{ins} \geq 50\%$ of initial limit



B32613, B32614

High pulse (wound)

Test	Reference	Conditions of test	Performance requirements
Endurance B	IEC 60384-16:2005	100 °C / 1.25 V _C / 2000 hours	No visible damage ΔC/C ₀ ≤ 5% Δ tan δ ≤ 0.002 R _{ins} ≥ 50% of initial limit

Important notes

The following applies to all products named in this publication:

1. Some parts of this publication contain **statements about the suitability of our products for certain areas of application**. These statements are based on our knowledge of typical requirements that are often placed on our products in the areas of application concerned. We nevertheless expressly point out **that such statements cannot be regarded as binding statements about the suitability of our products for a particular customer application**. As a rule, EPCOS is either unfamiliar with individual customer applications or less familiar with them than the customers themselves. For these reasons, it is always ultimately incumbent on the customer to check and decide whether an EPCOS product with the properties described in the product specification is suitable for use in a particular customer application.
2. We also point out that **in individual cases, a malfunction of electronic components or failure before the end of their usual service life cannot be completely ruled out in the current state of the art, even if they are operated as specified**. In customer applications requiring a very high level of operational safety and especially in customer applications in which the malfunction or failure of an electronic component could endanger human life or health (e.g. in accident prevention or lifesaving systems), it must therefore be ensured by means of suitable design of the customer application or other action taken by the customer (e.g. installation of protective circuitry or redundancy) that no injury or damage is sustained by third parties in the event of malfunction or failure of an electronic component.
3. **The warnings, cautions and product-specific notes must be observed.**
4. In order to satisfy certain technical requirements, **some of the products described in this publication may contain substances subject to restrictions in certain jurisdictions (e.g. because they are classed as hazardous)**. Useful information on this will be found in our Material Data Sheets on the Internet (www.epcos.com/material). Should you have any more detailed questions, please contact our sales offices.
5. We constantly strive to improve our products. Consequently, **the products described in this publication may change from time to time**. The same is true of the corresponding product specifications. Please check therefore to what extent product descriptions and specifications contained in this publication are still applicable before or when you place an order. We also **reserve the right to discontinue production and delivery of products**. Consequently, we cannot guarantee that all products named in this publication will always be available. The aforementioned does not apply in the case of individual agreements deviating from the foregoing for customer-specific products.
6. Unless otherwise agreed in individual contracts, **all orders are subject to the current version of the "General Terms of Delivery for Products and Services in the Electrical Industry" published by the German Electrical and Electronics Industry Association (ZVEI)**.



Important notes

7. **Our manufacturing sites serving the automotive business apply the IATF 16949 standard.** The IATF certifications confirm our compliance with requirements regarding the quality management system in the automotive industry. Referring to customer requirements and customer specific requirements (“CSR”) TDK always has and will continue to have the policy of respecting individual agreements. Even if IATF 16949 may appear to support the acceptance of unilateral requirements, we hereby like to emphasize that **only requirements mutually agreed upon can and will be implemented in our Quality Management System.** For clarification purposes we like to point out that obligations from IATF 16949 shall only become legally binding if individually agreed upon.
8. The trade names EPCOS, CeraCharge, CeraDiode, CeraLink, CeraPad, CeraPlas, CSMP, CTVS, DeltaCap, DigiSiMic, ExoCore, FilterCap, FormFit, LeaXield, MiniBlue, MiniCell, MKD, MKK, MotorCap, PCC, PhaseCap, PhaseCube, PhaseMod, PhiCap, PowerHap, PQSine, PQvar, SIFERRIT, SIFI, SIKOREL, SilverCap, SIMDAD, SiMic, SIMID, SineFormer, SIOV, ThermoFuse, WindCap are **trademarks registered or pending** in Europe and in other countries. Further information will be found on the Internet at www.epcos.com/trademarks.

Release 2018-06

Looking for pricing, stock, or lifecycle information?

Click below to explore more details on WIN SOURCE:

-  [View B32613A2332J008 on WIN SOURCE](#)
-  [EPCOS \(TDK\) Information](#)

Optimize Your Supply Chain with WIN SOURCE Solutions

-  Global Sourcing Solution
-  Obsolete Management
-  Cost Control Management
-  Shortage Management
-  Alternative Solution
-  Excess Inventory Management