



**THE DATASHEET OF  
MAPD-011007**



# 2-Way 0° Power Divider 5 - 2150 MHz



MAPD-011007

Rev. V7

## Features

- 2-Way, 0°
- Surface Mount Technology
- RoHS\* Compliant
- Available on Tape & Reel

## Applications

- CATV Broadband and FTTx applications.

## Description

The MAPD-011007 is a 2-way 0° power divider in a surface mount package.

## Functional Schematic

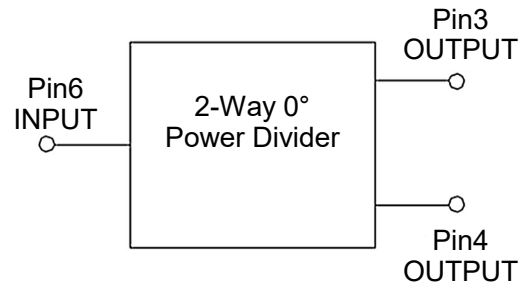

## Ordering Information<sup>1,2</sup>

Part Number	Package
MAPD-011007	bulk
MAPD-011007-TB	Sample Board

1. Reference Application Note M513 for reel size information.
2. All sample boards include 5 loose parts.

## Pin Configuration<sup>3</sup>

Pin #	Function
1	Ground
2, 5	External Shunt Capacitors
3	Output
4	Output
6	Input

3. MACOM recommends connecting unused package pins to ground.

\* Restrictions on Hazardous Substances, compliant to current RoHS EU directive.

# 2-Way 0° Power Divider

## 5 - 2150 MHz



MAPD-011007

Rev. V7

**Electrical Specifications: Freq. = 5 - 2150 MHz, T<sub>A</sub> = 25°C, Z<sub>0</sub> = 75 Ω, P<sub>IN</sub> = 0 dBm**

Parameter	Test Conditions Frequency (MHz)	Units	Min.	Typ.	Max.
Power Split	—	dB	—	3	—
Insertion Loss (pin 6 - pin 4)	5 - 1002	dB	—	0.3	0.7
	1003 - 1218			0.5	1.0
	1218 - 1600			0.6	1.2
	1600 - 2150			1.0	2.0
Insertion Loss (pin 6 - pin 3)	5 - 1002	dB	—	0.6	1.0
	1003 - 1218			0.8	1.2
	1218 - 1600			1.0	1.6
	1600 - 2150			1.5	3.2
Amplitude Balance	5 - 1002	dB	—	0.3	0.5
	1003 - 1218			0.3	0.5
	1218 - 1600			0.3	0.5
	1600 - 2150			0.5	1.5
Phase Balance	5 - 1002	degree	—	0.8	4.0
	1003 - 1600			1.0	6.0
	1600 - 2150			0.2	7.0
Input Return Loss (pin 6)	5 - 1002	dB	20	39	—
	1003 - 1600		14	22	
	1600 - 2150		11	18	
Output Return Loss (pin 3)	5 - 1002	dB	17	28	—
	1003 - 1600		13	18	
	1600 - 2150		9	14	
Output Return Loss (pin 4)	5 - 1002	dB	20	40	—
	1003 - 1600		15	22	
	1600 - 2150		12	18	
Isolation (pin 4 - pin 3)	5 - 10	dB	24	30	—
	10 - 65		30	42	
	66 - 870		26	34	
	871 - 1002		24	31	
	1003 - 1600		22	31	
	1600 - 2150		15	24	

### Absolute Maximum Ratings<sup>4,5</sup>

Parameter	Absolute Maximum
Input RF Power <sup>6</sup>	0.5 W
DC Current	500 mA
Operating Temperature	-40°C to +105°C

4. Exceeding any one or combination of these limits may cause permanent damage to this device.
5. MACOM does not recommend sustained operation near these survivability limits.
6. Specified at +25°C only.

# 2-Way 0° Power Divider

## 5 - 2150 MHz



MAPD-011007

Rev. V7

Typical Performance Curves:  $P_{IN} = 0 \text{ dBm}$ ,  $T_A = 25^\circ\text{C}$ ,  $Z_0 = 75 \Omega$

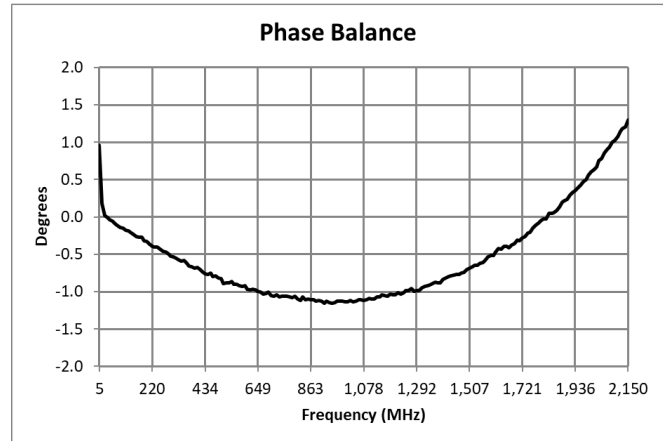
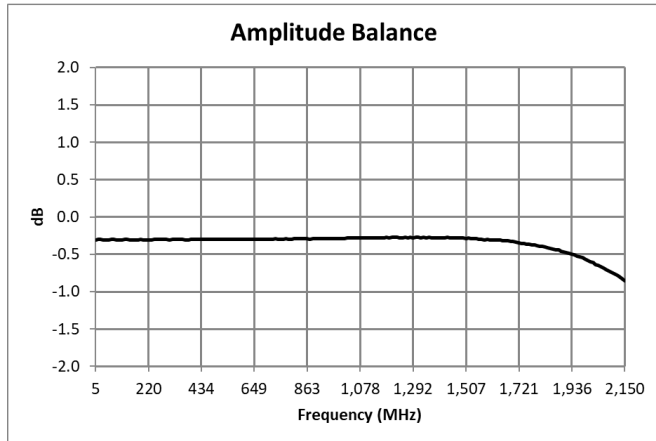
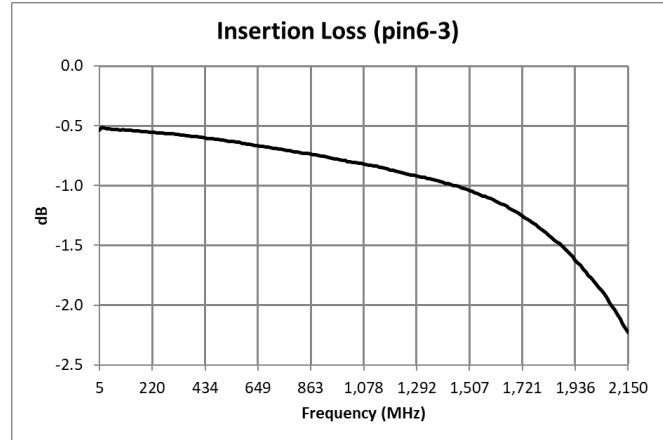
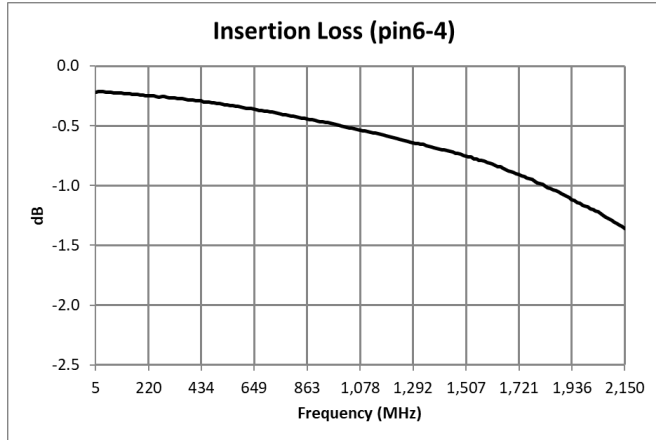

# 2-Way 0° Power Divider 5 - 2150 MHz



MAPD-011007

Rev. V7

Typical Performance Curves:  $P_{IN} = 0 \text{ dBm}$ ,  $T_A = 25^\circ\text{C}$ ,  $Z_0 = 75 \Omega$

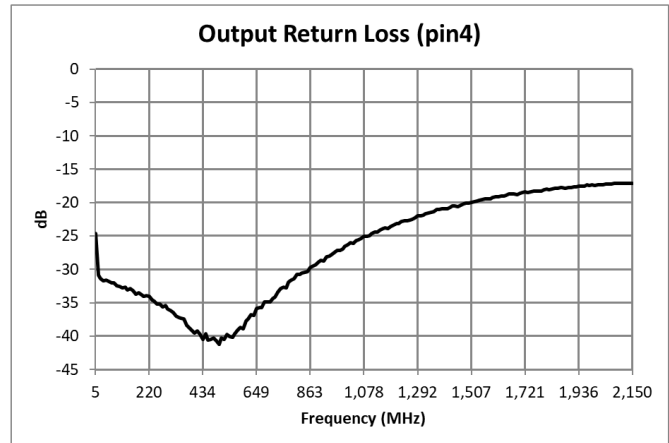
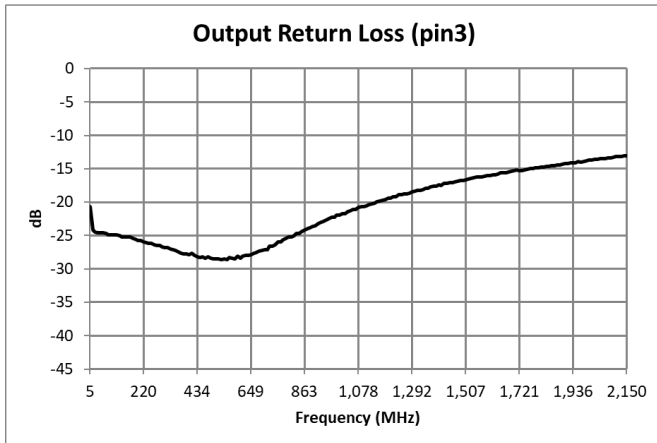
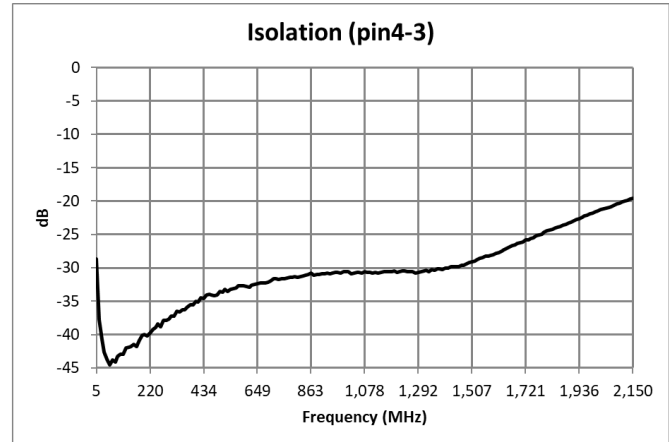
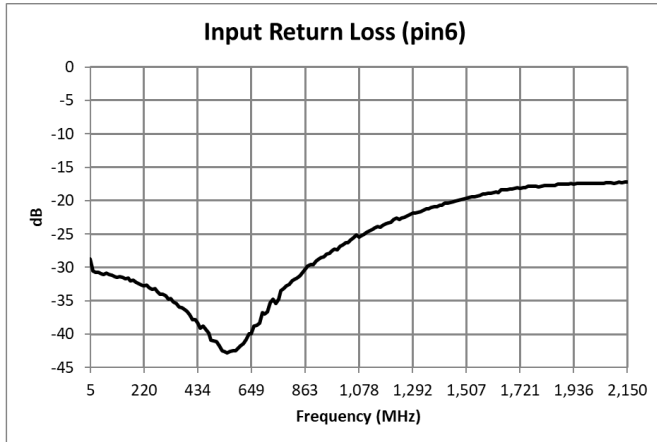

# 2-Way 0° Power Divider 5 - 2150 MHz



MAPD-011007

Rev. V7

## PCB Layout<sup>7</sup>

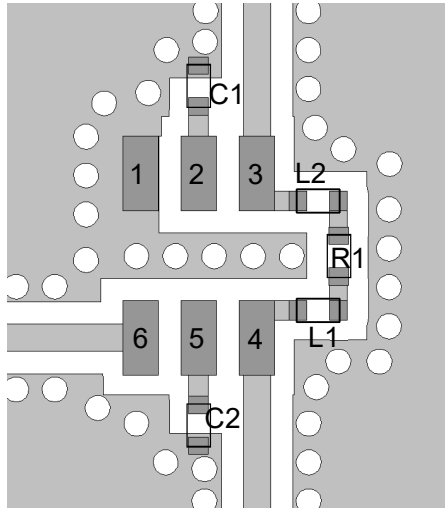

7. FR4 dielectric 1.6mm, GCWG W=0.7mm G=0.57mm

## Parts List

Part	Value	Case Style
R1	240Ω +/-1%	0402
C1 & C2	0.5pF +/-5%	0402
L1 & L2	8.2nH +/-2%	0402

## Outline Drawing<sup>8,9,10,11</sup>

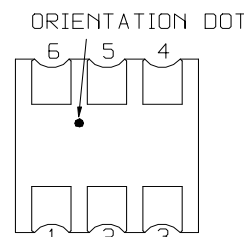
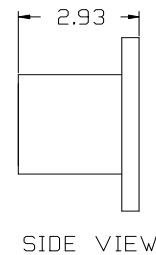
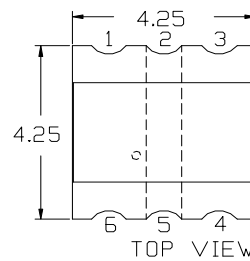

BOTTOM VIEW

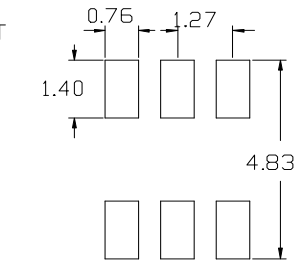

FOOTPRINT FOR PCB DESIGN

- 8. Dimensions in mm.
- 9. Tolerance: ±0.2mm unless otherwise noted.
- 10. Model number and lot code printed on reel.
- 11. Plating finish: ENIG on both sides, 0.05 to 0.1µm gold over 3 to 6µm nickel

## Application Schematic

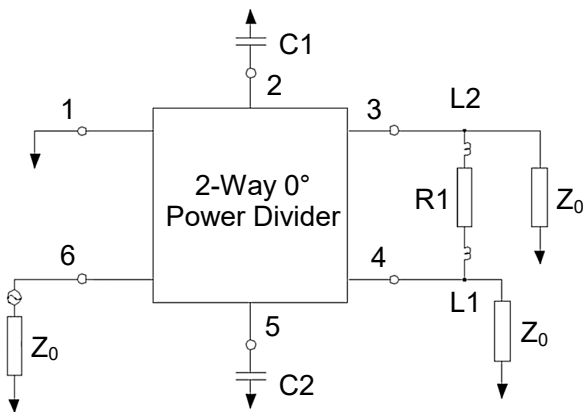

## Tape & Reel Information

Parameter	Units	Value
Qty per reel	-	2000
Reel Size	mm	330
Tape Width	mm	12.0
Pitch	mm	8.0
Orientation	-	F18
Reference Application Note ANI-019 for orientation		

## Carrier Tape Orientation

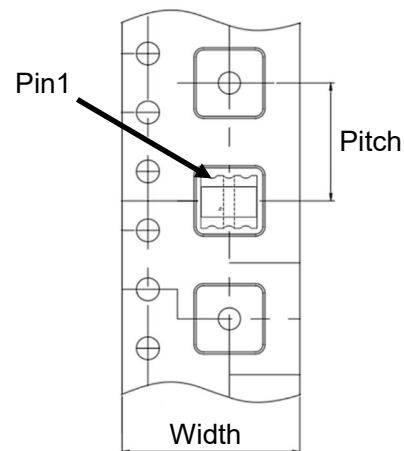

5

MACOM Technology Solutions Inc. (MACOM) and its affiliates reserve the right to make changes to the product(s) or information contained herein without notice. Visit [www.macom.com](http://www.macom.com) for additional data sheets and product information.

For further information and support please visit: <https://www.macom.com/support>

DC-0001199

## 2-Way 0° Power Divider 5 - 2150 MHz



MAPD-011007

Rev. V7

MACOM Technology Solutions Inc. ("MACOM"). All rights reserved.

These materials are provided in connection with MACOM's products as a service to its customers and may be used for informational purposes only. Except as provided in its Terms and Conditions of Sale or any separate agreement, MACOM assumes no liability or responsibility whatsoever, including for (i) errors or omissions in these materials; (ii) failure to update these materials; or (iii) conflicts or incompatibilities arising from future changes to specifications and product descriptions, which MACOM may make at any time, without notice. These materials grant no license, express or implied, to any intellectual property rights.

THESE MATERIALS ARE PROVIDED "AS IS" WITH NO WARRANTY OR LIABILITY, EXPRESS OR IMPLIED, RELATING TO SALE AND/OR USE OF MACOM PRODUCTS INCLUDING FITNESS FOR A PARTICULAR PURPOSE, MERCHANTABILITY, INFRINGEMENT OF INTELLECTUAL PROPERTY RIGHT, ACCURACY OR COMPLETENESS, OR SPECIAL, INDIRECT, INCIDENTAL, OR CONSEQUENTIAL DAMAGES WHICH MAY RESULT FROM USE OF THESE MATERIALS.

MACOM products are not intended for use in medical, lifesaving or life sustaining applications. MACOM customers using or selling MACOM products for use in such applications do so at their own risk and agree to fully indemnify MACOM for any damages resulting from such improper use or sale.

## Looking for pricing, stock, or lifecycle information?

Click below to explore more details on WIN SOURCE:

- ⊖ [View MAPD-011007](#) on WIN SOURCE
- ⊖ [M/A-Com Technology Solutions](#) Information

## Optimize Your Supply Chain with WIN SOURCE Solutions

- ✓ Global Sourcing Solution
- ✓ Obsolete Management
- ✓ Cost Control Management
- ✓ Shortage Management
- ✓ Alternative Solution
- ✓ Excess Inventory Management