



THE DATASHEET OF
178.6116.2502



Blade Fuseholders - FH2 Stackable Block Fuseholder for ATO® Style Blade Fuse Rated 80V

RoHS



Specifications

- Housing:** Out of thermoplastic (UL 94-V0, heat-resistant)
- Connections:** Leaf spring connector systems, crimp contacts, copper alloy, tinned
- Color:** Black
- Cover:** Thermoplastic (transparent)

Blockholder for ATO / FKS size fuses-links. Attachable in X- and Y-direction. Rated voltage 80V; crimp terminals.

Blockhalter für Sicherungen in ATO / FKS-Größe. Montage in X- und Y-Richtung möglich. Nennspannung 80V, Crimp-Kontakte.

Dimensions in mm / Maße in mm

Chart for row-mounting

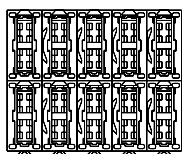

10er/pcs. Block

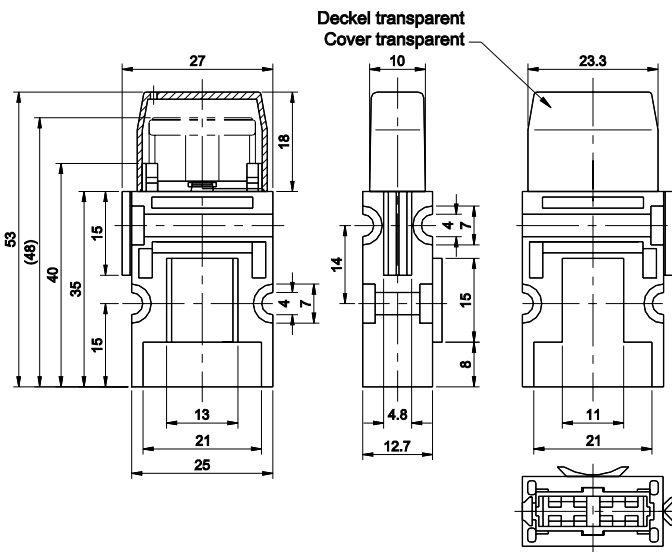
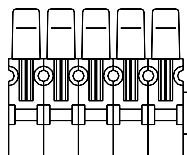

Part Number Artikel-Nr.	Description Beschreibung	Contact Temperature Kontakttemperatur
178.6105.000_	Complete with DFK 1.5 - 2.5 mm ²	max. 130°C
178.6115.000_	Housing	—
178.6125.000_	Cover	—
178.6116.100_*	DFK-Kontakte 0.5-1.0mm ²	max. 130°C
178.6116.250_*	Contacts 1.5-2.5mm ²	max. 130°C
178.6116.600_*	Contacts 4.0-6.0mm ²	max. 130°C



* Crimping tool available on request.

Last figure of part number = packaging code, see Section "Packaging Index," pg. 157.

Corresponding fuse links see Section "Blade Fuses."

Looking for pricing, stock, or lifecycle information?

Click below to explore more details on WIN SOURCE:

-  [View 178.6116.2502 on WIN SOURCE](#)
-  [Littelfuse Inc. Information](#)

Optimize Your Supply Chain with WIN SOURCE Solutions

-  Global Sourcing Solution
-  Obsolete Management
-  Cost Control Management
-  Shortage Management
-  Alternative Solution
-  Excess Inventory Management