



DESIGNED & DIMENSIONED  
IN MILLIMETERS [INCHES]

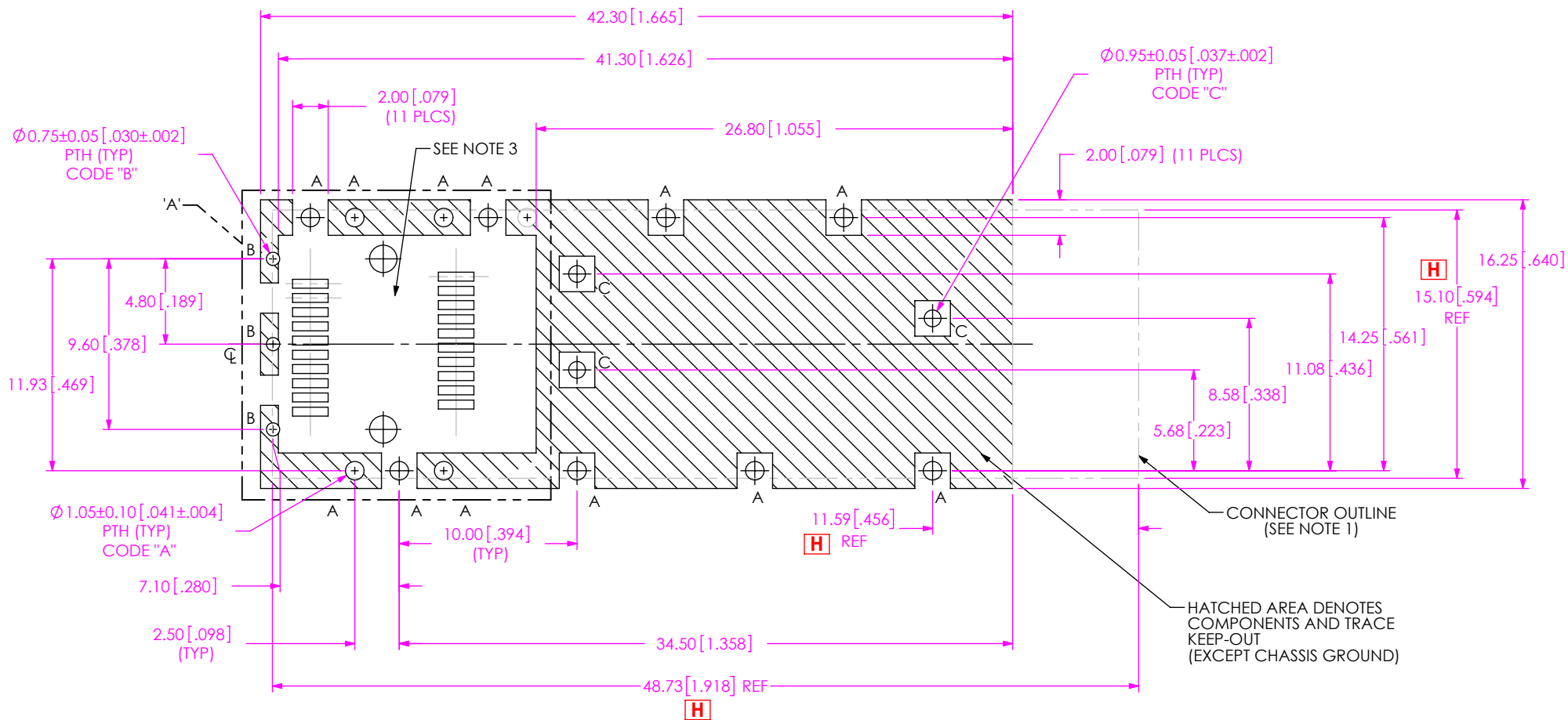

FIG 1  
SFPC-PF SHOWN

NOTES:

1. CONNECTOR ENVELOPE DIMENSIONS. OTHER COMPONENTS PLACED ON PCB SHALL AVOID THIS ZONE.
2. MSA SPECIFICATION FOR SFP TO SUPERCEDE SAMTEC RECOMMENDED FOOTPRINT.
3. THIS AREA DENOTES COMPONENT KEEP-OUT (TRACES ALLOWED)
4. ALL OF THE SOLDER TAILS ON -PF AND -PC ARE OPTIONAL TO SOLDER.

**PROPRIETARY NOTE**  
THIS DOCUMENT CONTAINS CONFIDENTIAL AND PROPRIETARY INFORMATION AND ALL DESIGN, MANUFACTURING, REPRODUCTION, USE, PATENT RIGHTS AND SALES RIGHTS ARE EXPRESSLY RESERVED BY SAMTEC, INC. THIS DOCUMENT SHALL NOT BE DISCLOSED, IN WHOLE OR PART, TO ANY UNAUTHORIZED PERSON OR ENTITY NOR REPRODUCED, TRANSFERRED OR INCORPORATED IN ANY OTHER PROJECT IN ANY MANNER WITHOUT THE EXPRESS WRITTEN CONSENT OF SAMTEC, INC.



520 PARK EAST BLVD, NEW ALBANY, IN 47150  
PHONE: 812-944-6733 FAX: 812-948-5047  
e-Mail: info@SAMTEC.com code: 55322

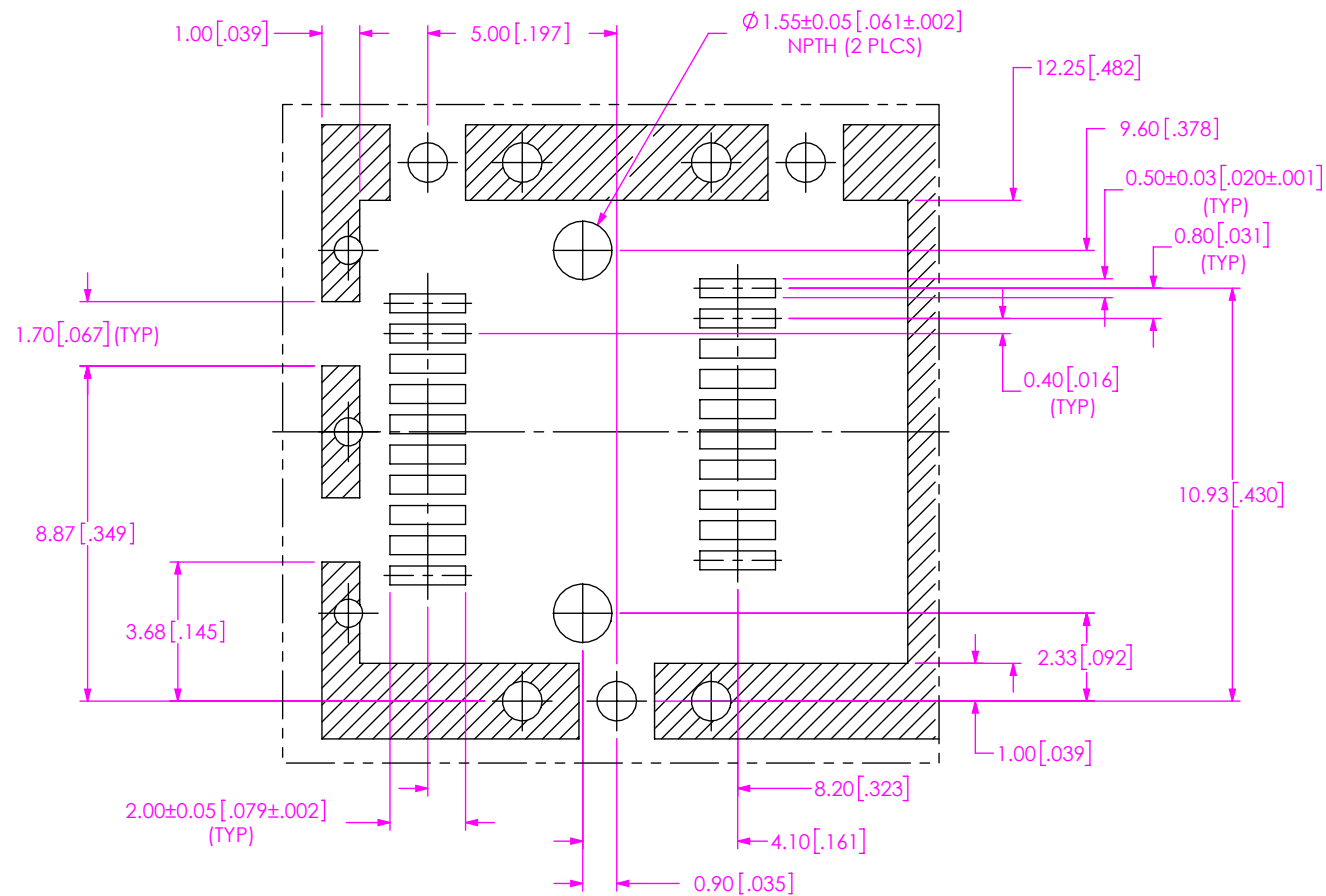

DETAIL 'A'  
SCALE 5 : 1

**PROPRIETARY NOTE**  
 THIS DOCUMENT CONTAINS CONFIDENTIAL AND PROPRIETARY INFORMATION AND ALL DESIGN, MANUFACTURING, REPRODUCTION, USE, PATENT RIGHTS AND SALES RIGHTS ARE EXPRESSLY RESERVED BY SAMTEC, INC. THIS DOCUMENT SHALL NOT BE DISCLOSED, IN WHOLE OR PART, TO ANY UNAUTHORIZED PERSON OR ENTITY NOR REPRODUCED, TRANSFERRED OR INCORPORATED IN ANY OTHER PRODUCT IN ANY MANNER WITHOUT THE EXPRESS WRITTEN CONSENT OF SAMTEC, INC.



520 PARK EAST BLVD, NEW ALBANY, IN 47150  
 PHONE: 812-944-6733 FAX: 812-948-5047  
 e-Mail: info@SAMTEC.com code: 55322

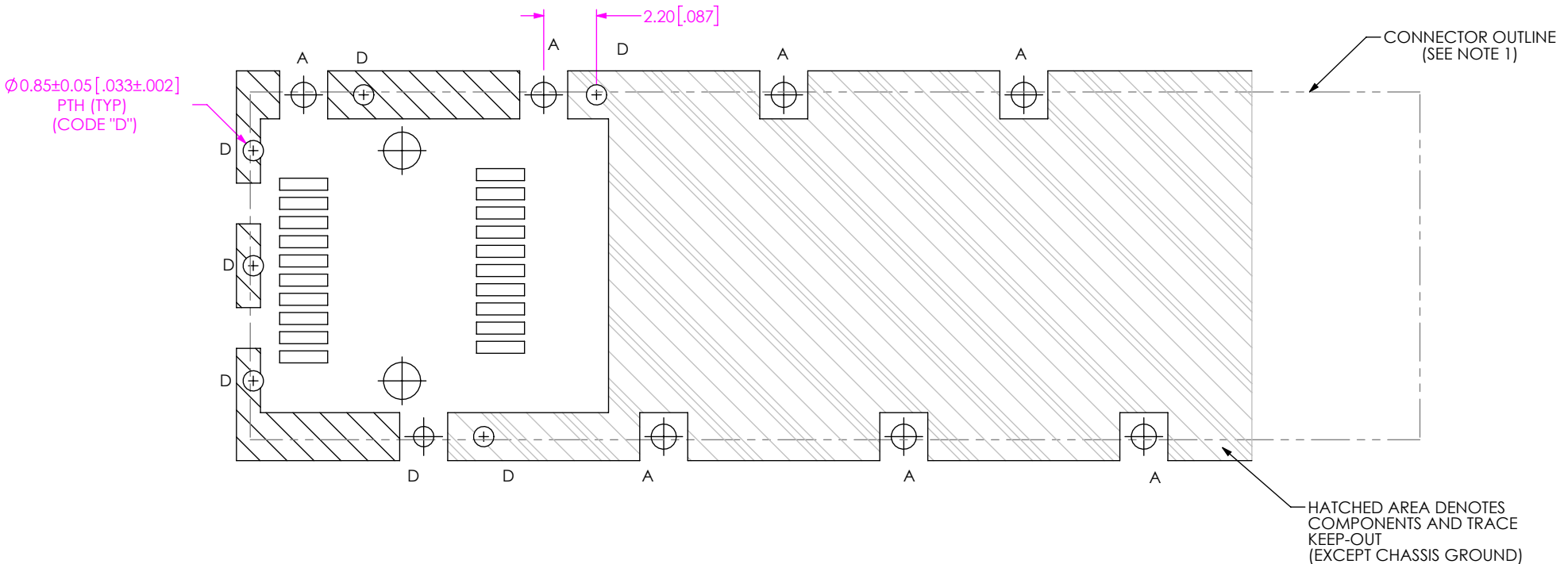

FIG 2  
 SFPC-PC SHOWN  
 (DIFFERENT AS SHOWN, OTHERWISE SAME AS FIG 1)

\* PROPRIETARY NOTE \*  
 THIS DOCUMENT CONTAINS CONFIDENTIAL AND PROPRIETARY INFORMATION AND ALL DESIGN, MANUFACTURING, REPRODUCTION, USE, PATENT RIGHTS AND SALES RIGHTS ARE EXPRESSLY RESERVED BY SAMTEC, INC. THIS DOCUMENT SHALL NOT BE DISCLOSED, IN WHOLE OR PART, TO ANY UNAUTHORIZED PERSON OR ENTITY NOR REPRODUCED, TRANSFERRED OR INCORPORATED IN ANY OTHER PRODUCT IN ANY MANNER WITHOUT THE EXPRESS WRITTEN CONSENT OF SAMTEC, INC.



520 PARK EAST BLVD, NEW ALBANY, IN 47150  
 PHONE: 812-944-6733 FAX: 812-948-5047  
 e-Mail: info@SAMTEC.com code: 55322

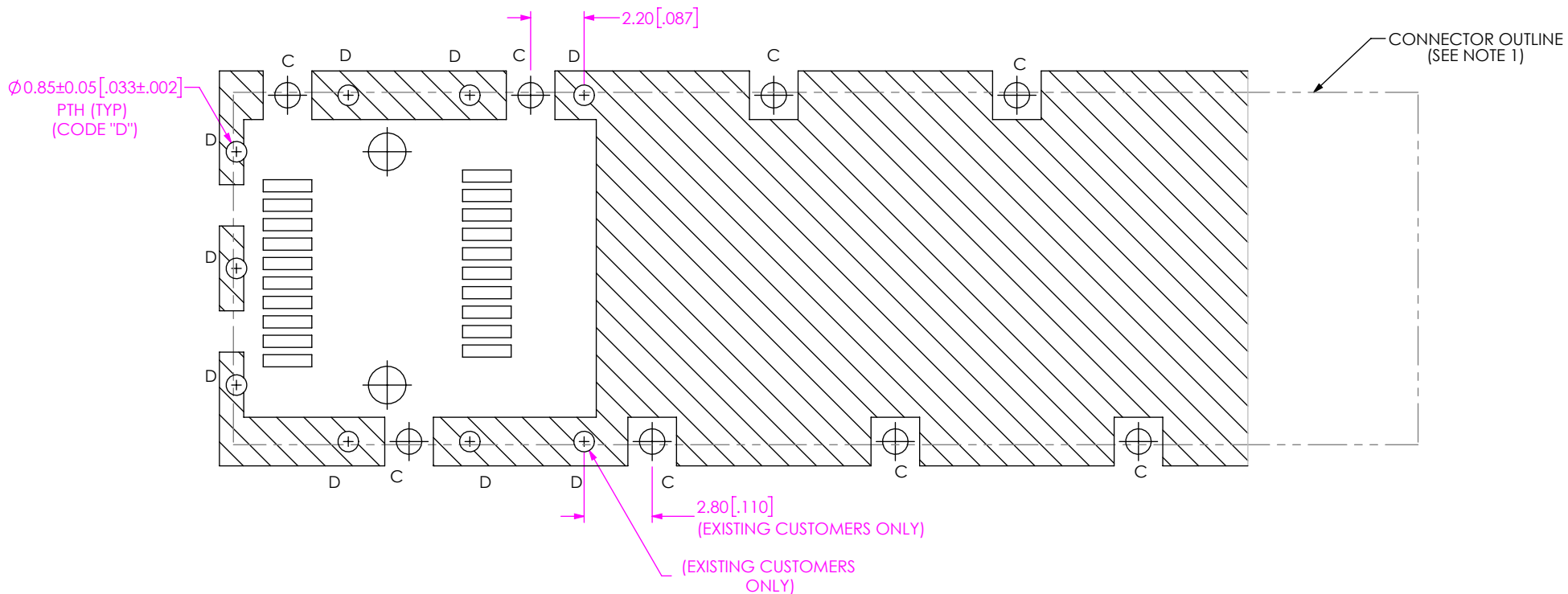

FIG 3  
 SFPC-SL SHOWN  
 (DIFFERENT AS SHOWN, OTHERWISE SAME AS FIG 1)

\* PROPRIETARY NOTE \*  
 THIS DOCUMENT CONTAINS CONFIDENTIAL AND PROPRIETARY INFORMATION AND ALL DESIGN, MANUFACTURING, REPRODUCTION, USE, PATENT RIGHTS AND SALES RIGHTS ARE EXPRESSLY RESERVED BY SAMTEC, INC. THIS DOCUMENT SHALL NOT BE DISCLOSED, IN WHOLE OR PART, TO ANY UNAUTHORIZED PERSON OR ENTITY NOR REPRODUCED, TRANSFERRED OR INCORPORATED IN ANY OTHER PROJECT IN ANY MANNER WITHOUT THE EXPRESS WRITTEN CONSENT OF SAMTEC, INC.



520 PARK EAST BLVD, NEW ALBANY, IN 47150  
 PHONE: 812-944-6733 FAX: 812-948-5047  
 e-Mail: info@SAMTEC.com code: 55322

| TABLE 1     |          |
|-------------|----------|
| TAIL OPTION | CODE "E" |
| -PF         | 1.05     |
| -PC         | 1.05     |
| -SL         | 0.95     |

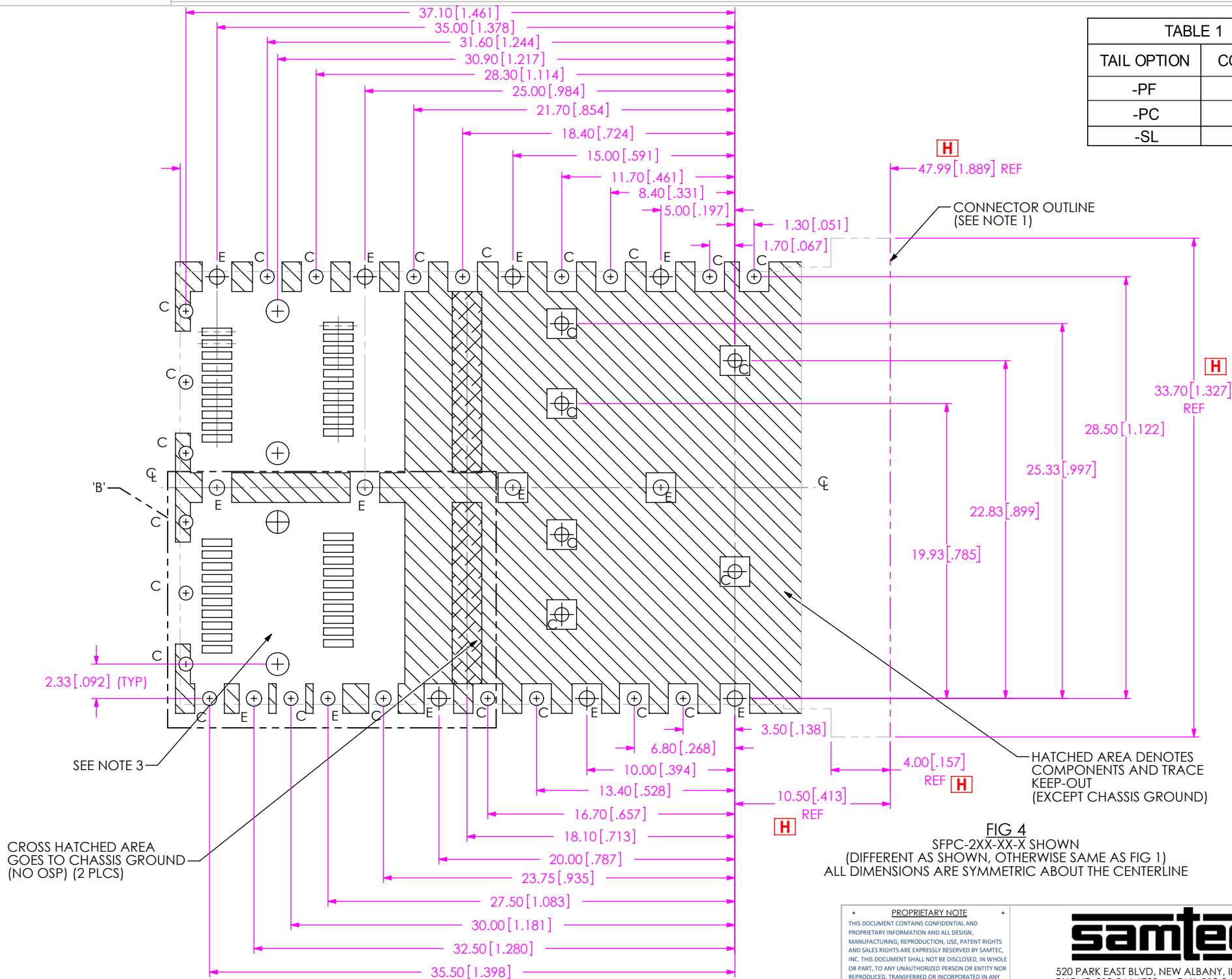

**PROPRIETARY NOTE**  
THIS DOCUMENT CONTAINS CONFIDENTIAL AND PROPRIETARY INFORMATION AND ALL DESIGN, MANUFACTURING, REPRODUCTION, USE, PATENT RIGHTS AND SALES RIGHTS ARE EXPRESSLY RESERVED BY SAMTEC, INC. THIS DOCUMENT SHALL NOT BE DISCLOSED, IN WHOLE OR PART, TO ANY UNAUTHORIZED PERSON OR ENTITY NOR REPRODUCED, TRANSFERRED OR INCORPORATED IN ANY OTHER PROJECT IN ANY MANNER WITHOUT THE EXPRESS WRITTEN CONSENT OF SAMTEC, INC.



520 PARK EAST BLVD., NEW ALBANY, IN 47150  
PHONE: 812-944-6733 FAX: 812-948-5047  
e-Mail: info@SAMTEC.com code: 55322

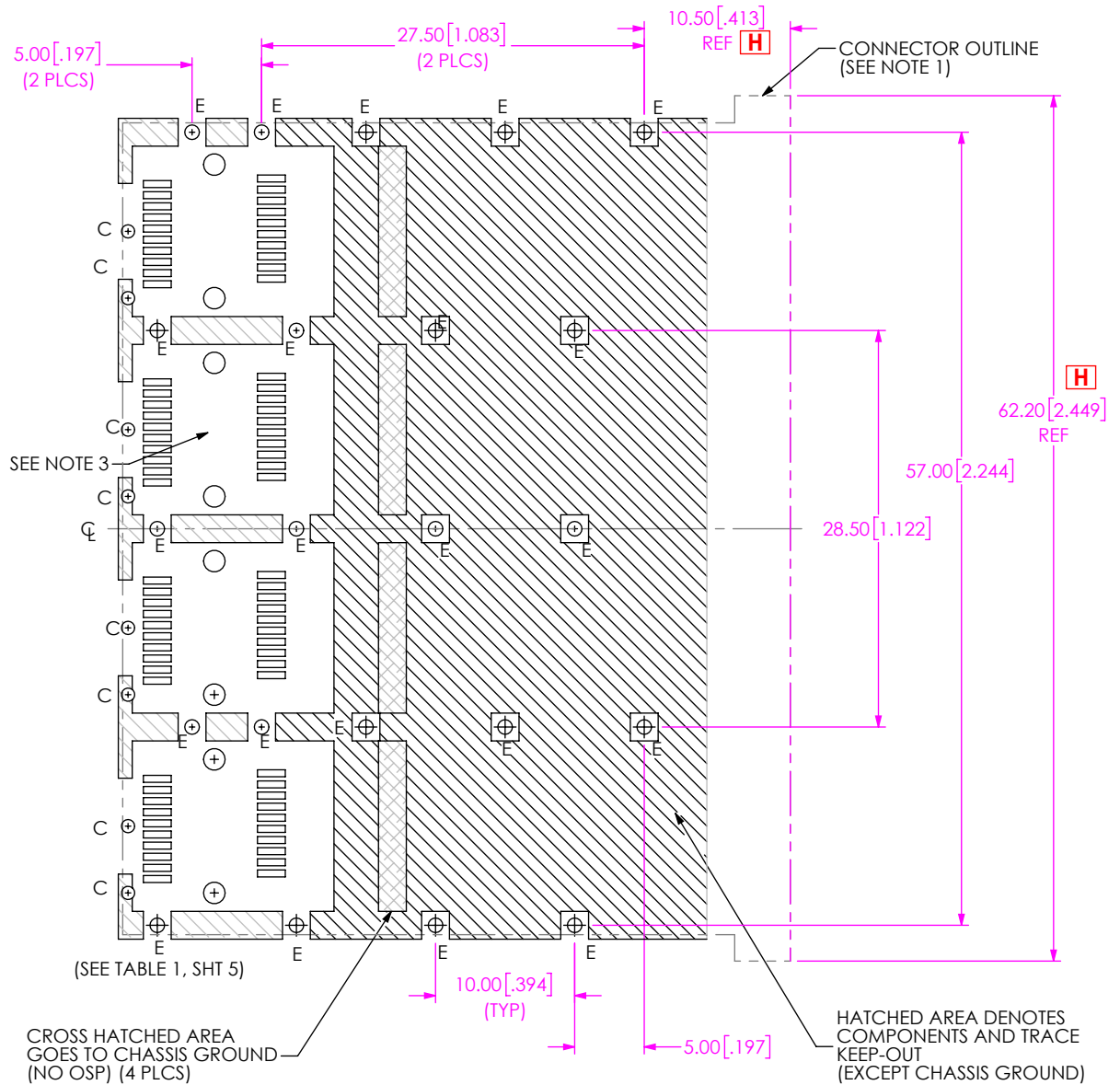
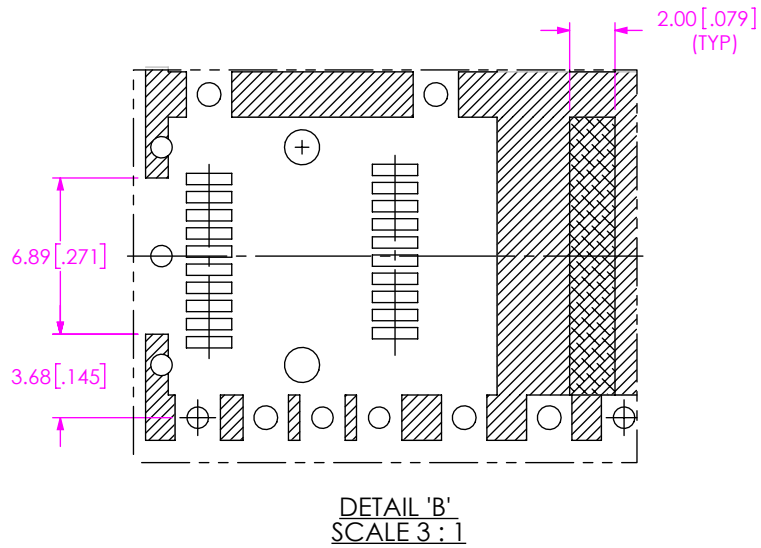

FIG 5  
SFPC-4XX-XX-X SHOWN  
(DIFFERENT AS SHOWN, OTHERWISE SAME AS FIG 1 & 4)  
ALL DIMENSIONS ARE SYMMETRIC ABOUT THE CENTERLINE

**PROPRIETARY NOTE**  
THIS DOCUMENT CONTAINS CONFIDENTIAL AND PROPRIETARY INFORMATION AND ALL DESIGN, MANUFACTURING, REPRODUCTION, USE, PATENT RIGHTS AND SALES RIGHTS ARE EXPRESSLY RESERVED BY SAMTEC, INC. THIS DOCUMENT SHALL NOT BE DISCLOSED, IN WHOLE OR PART, TO ANY UNAUTHORIZED PERSON OR ENTITY NOR REPRODUCED, TRANSFERRED OR INCORPORATED IN ANY OTHER PROJECT IN ANY MANNER WITHOUT THE EXPRESS WRITTEN CONSENT OF SAMTEC, INC.



520 PARK EAST BLVD., NEW ALBANY, IN 47150  
PHONE: 812-944-6733 FAX: 812-948-5047  
e-Mail: info@SAMTEC.com code: 55322



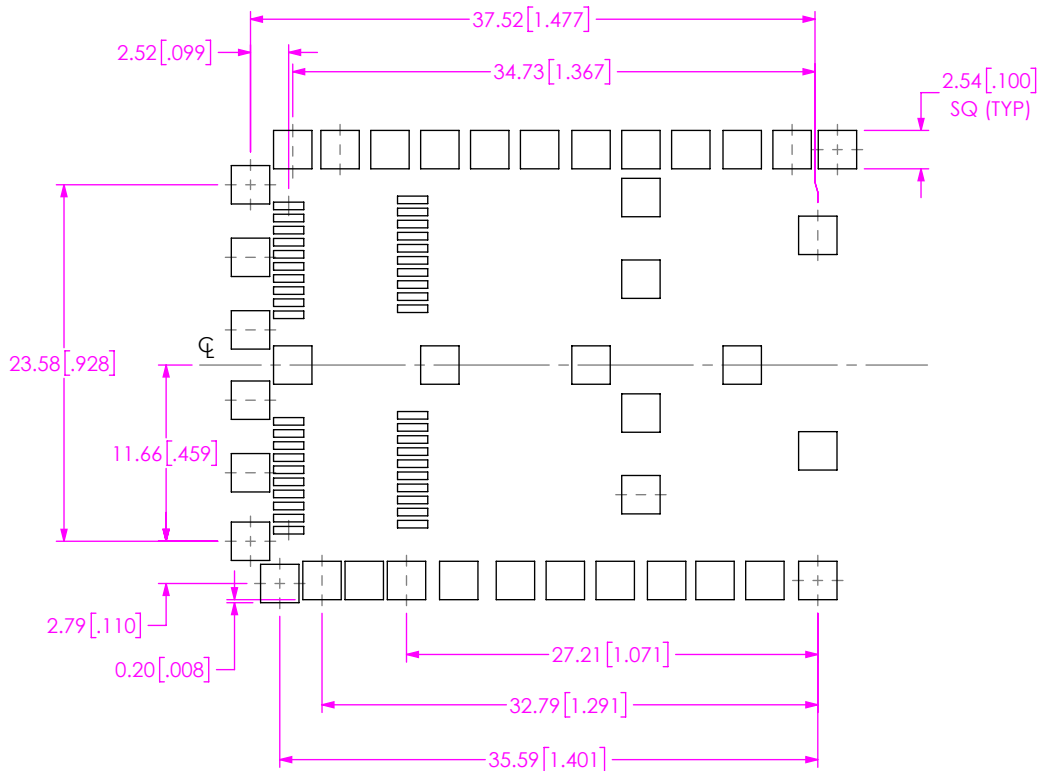

FIG 9  
SFPC-2SL-XX-X SHOWN  
(DIFFERENT AS SHOWN, OTHERWISE SAME AS FIG 4 & 6)

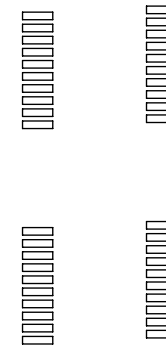

FIG 10  
SFPC-2PX-XX-X SHOWN  
(FOR PF & PC TAILS ONLY)  
(DIFFERENT AS SHOWN, OTHERWISE SAME AS FIG 9)

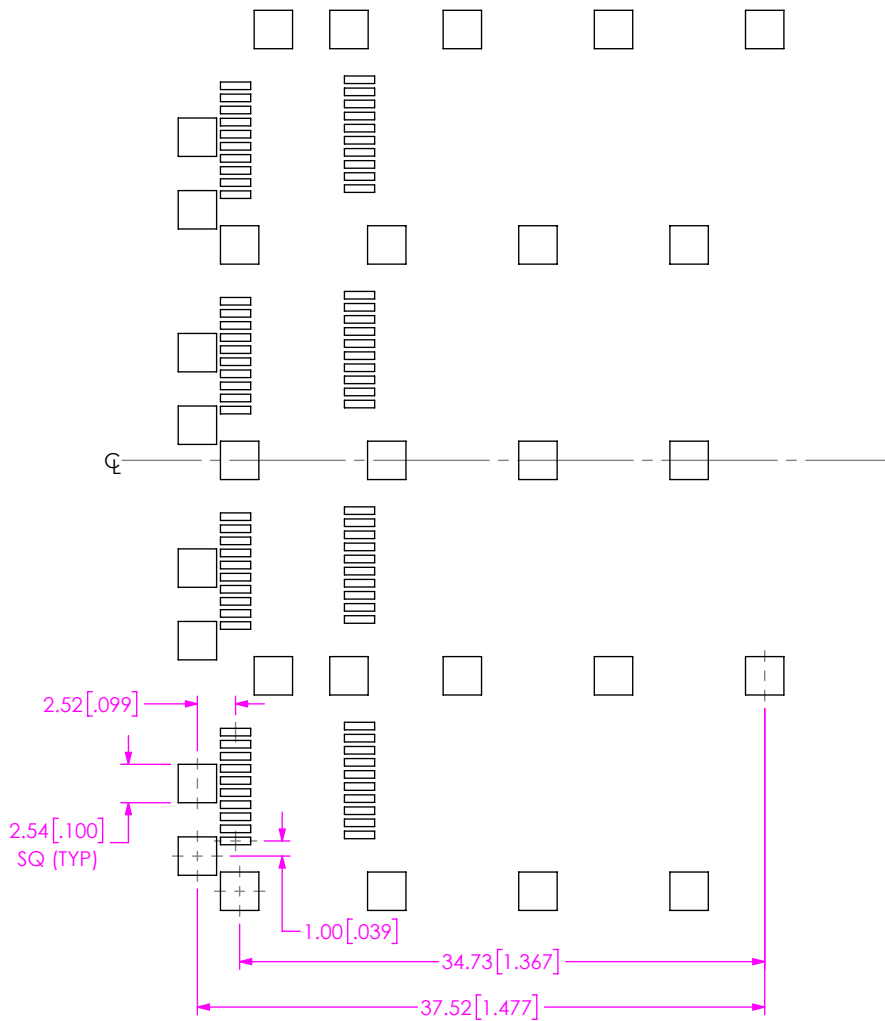

FIG 11  
SFPC-4SL-XX-X SHOWN  
(DIFFERENT AS SHOWN, OTHERWISE SAME AS FIG 5 & 6)

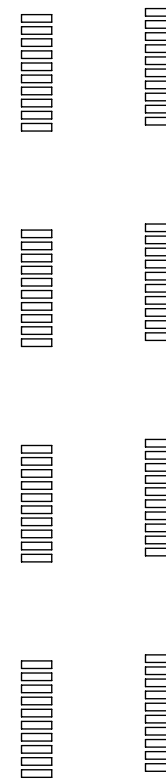

FIG 12  
SFPC-4PX-XX-X SHOWN  
(FOR PC & PF OPTION ONLY)  
(DIFFERENT AS SHOWN, OTHERWISE SAME AS FIG 11)



**PROPRIETARY NOTE**  
THIS DOCUMENT CONTAINS CONFIDENTIAL AND PROPRIETARY INFORMATION AND ALL DESIGN, MANUFACTURING, REPRODUCTION, USE, PATENT RIGHTS AND SALES RIGHTS ARE EXPRESSLY RESERVED BY SAMTEC, INC. THIS DOCUMENT SHALL NOT BE DISCLOSED, IN WHOLE OR PART, TO ANY UNAUTHORIZED PERSON OR ENTITY NOR REPRODUCED, TRANSFERRED OR INCORPORATED IN ANY OTHER PROJECT IN ANY MANNER WITHOUT THE EXPRESS WRITTEN CONSENT OF SAMTEC, INC.



520 PARK EAST BLVD, NEW ALBANY, IN 47150  
PHONE: 812-944-6733 FAX: 812-948-5047  
e-Mail: info@SAMTEC.com code: 55322

## Looking for pricing, stock, or lifecycle information?

Click below to explore more details on WIN SOURCE:

-  [View SFPC-PF on WIN SOURCE](#)
-  [Samtec Inc. Information](#)

## Optimize Your Supply Chain with WIN SOURCE Solutions

-  Global Sourcing Solution
-  Obsolete Management
-  Cost Control Management
-  Shortage Management
-  Alternative Solution
-  Excess Inventory Management