



THE DATASHEET OF
01000056Z



Fuse Blocks and Clips

For 3AG Fuses

RoHS 3AG Screw Terminal Laminated Base Type



APPROVALS: 356 000 Series (250V) Recognized under the Components Program of Underwriters Laboratories.

SPECIFICATIONS:

Electrical: Rated for currents up to 15 amperes (units with spring brass clips) or up to 30 amperes (beryllium copper clips).

Clips: 356 000 Series: Nickel-plated spring brass.

359 000 Series: Silver-plated beryllium copper.

Terminals: 8-32THD screw type.

Base: Black phenolic laminate.

Mounting Hole: 3AG Block: Reference Dimensions
.142"/.147" diameter with .295"/.302"
x 82°C.S.

**ORDERING INFORMATION:
(Including Reference Dimensions)**

No. of Poles	For 3AG Fuses	
	Dimension "A"	Catalog Number
1	.78"	356 001 359 001
2	1.69"	356 002 359 002
3	2.59"	356 003 359 003
4	3.50"	356 004 359 004
5	4.41"	356 005 359 005
6	5.31"	356 006 359 006
7	6.21"	356 007 359 007
8	7.12"	356 008 359 008
9	8.03"	356 009 359 009
10	8.94"	356 010 359 010
11	9.84"	356 011 359 011
12	10.75"	356 012 359 012

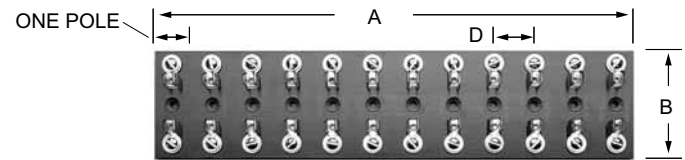

C = Board Thickness E = Overall Height
356 000, 359 000 and 556 000 Series

REFERENCE DIMENSIONS:

Fuse Type	A	B	C	D	E
3AG	See	2.38"	.25"	.91"	.73"

RoHS For 1/4" – 13/16" Diameter Fuses Rivet/Eyelet Mount Type

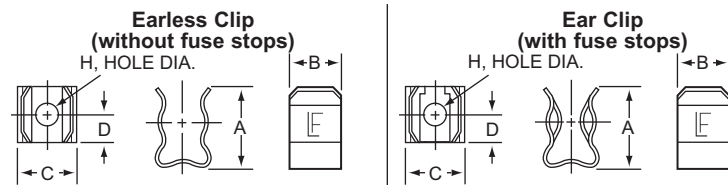

† See Ordering Information below.

RoHS For 1/4" Diameter Fuses Rivet/Eyelet Mount Solder Type

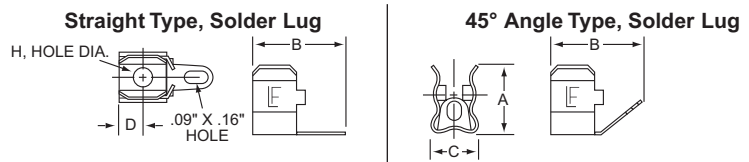

ORDERING INFORMATION:

Style	Fuse Type	Catalog Number		Fuse Diameter	A	B	C	D	H Diameter
		Spring Brass Nickel-plated	Beryllium Copper Silver-plated						
† Ear	3AG	101 001	121 001	1/4"	.48"	.31"	.30"	.16"	.131"
	Midget	105 001	125 001	13/32"	.75"	.44"	.52"	.22"	.196"
	NEC 1–30 amp	107 001	127 001	9/16"	.94"	.59"	.65"	.25"	.203"
	NEC 30–60 amp	109 001**	129 001	13/16"	1.31"	.75"	.87"	.30"	.265"
† Earless	3AG	101 002	121 002	1/4"	.48"	.31"	.30"	.16"	.131"
	Midget	105 002	125 002	13/32"	.75"	.44"	.52"	.22"	.196"
	NEC 1–30 amp	107 002	127 002	9/16"	.94"	.59"	.65"	.25"	.203"
	NEC 30–60 amp	109 002**	129 002	13/16"	1.31"	.75"	.87"	.30"	.265"
Solder Lug 45°	3AG	101 003*	121 004	1/4"	.47"	.56"	.31"	.16"	.131"
Solder Lug Straight	3AG	102 064*	—	1/4"	.47"	.64"	.31"	.16"	.131"

*Tin-plated **Bare Phos. Bronze

Fuse Blocks and Clips

For 1/4 Diameter Fuses

RoHS **Pb** **Traditional** P.C. Board Type

ORDERING INFORMATION:

Catalog Number	Clip Material*	Finish	Style
102 071	Spring Brass	Tin-plated	Ear
102 074	Spring Brass	Tin-plated	Earless
102 076	Spring Brass	Hot Tin	Ear
122 083	Beryllium Copper	Silver-plated	Ear
122 087	Beryllium Copper	Silver-plated	Earless
122 088	Beryllium Copper	Tin-plated	Ear
122 093	Beryllium Copper	Tin-plated	Earless



Nominal Fuse Length	Length "A"
5/8	.750
3/4	.875
7/8	1.000
1	1.125
1 1/16	1.187
1 1/4	1.347
1 7/16	1.562

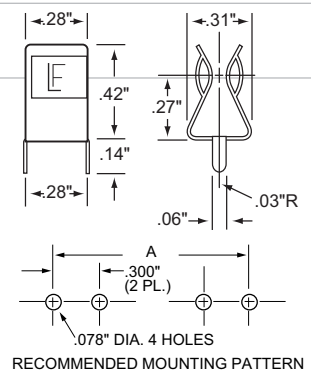

RoHS **Pb** **Bowed Tab** P.C. Board Type

Catalog Number	Clip Material*	Finish	Style
102 078	Spring Brass	Tin-plated	Earless
102 079	Spring Brass	Tin-plated	Ear

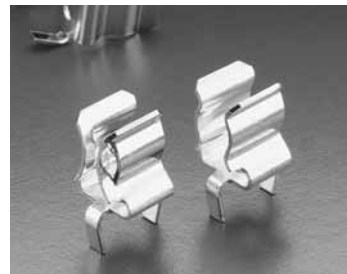

Nominal Fuse Length	Length "A"
5/8	.750
3/4	.875
7/8	1.000
1	1.125
1 1/16	1.187
1 1/4	1.347
1 7/16	1.562

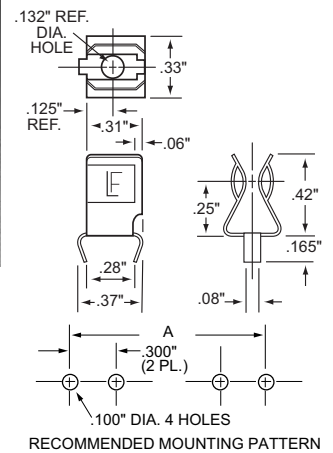

RoHS **Pb** **Low Profile** P.C. Board Type

Catalog Number	Clip Material*	Finish	Style
102 080	Spring Brass	Tin-plated	Ear
122 090	Beryllium Copper	Silver-plated	Ear



Nominal Fuse Length	Length "A"
5/8	.760
3/4	.880
7/8	1.005
1	1.130
1 1/16	1.195
1 1/4	1.380
1 7/16	1.570

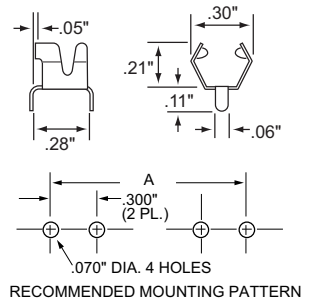

RoHS **Pb** **Low Profile** P.C. Board Type

Catalog Number	Clip Material*	Finish	Style
100 058	Spring Brass	Tin-plated	Ear

*NOTE: Spring brass clips are suitable for current levels up to 15 amperes; beryllium copper clips up to 30 amperes.



Nominal Fuse Length	Length "A"
1	0.781
1 1/4	1.035
1 7/16	1.250

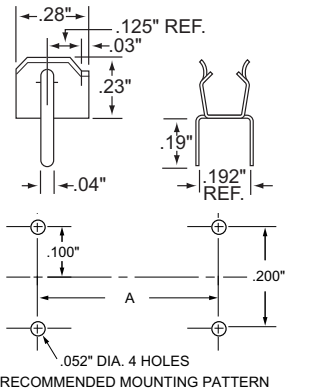

Fuse Blocks and Clips

For Various Diameter Fuses

RoHS ATO® Fuse Clip P.C. Board Type

ORDERING INFORMATION:

Catalog Number	Clip Material*	Finish
100 057	Spring Brass	Tin-plated

NOTE: #100 057 spring brass, tin-plated clips available for printed circuit board mounting. Suitable for current levels up to 15 amperes. First time fuse insertion force may approach 40 lbs.

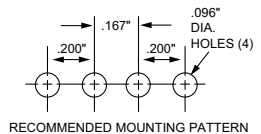
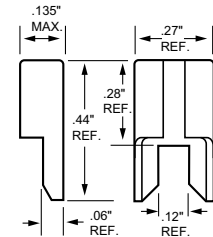

RoHS For 2AG or 5mm Diameter Fuses P.C. Board Type

ORDERING INFORMATION:

Catalog Number	Clip Material	Finish	Style
111 501	Spring Brass	Tin-plated	Ear
111 506	Beryllium Copper	Tin-plated	Ear
111 505	Beryllium Copper	Tin-plated	Surface Mount

NOTE: Suitable for current levels up to 10 amperes.

NOTE: Metric dimensions are shown. Inch dimensions are in parentheses.



Table	A Dim.
2AG	12.7 (.50")
5x20	17.8 (.70")

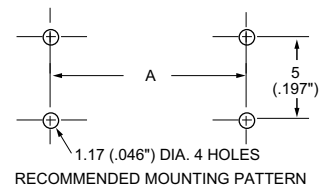
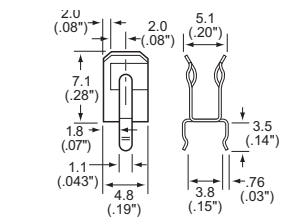

RoHS For 5mm Diameter Fuses P.C. Board Type

ORDERING INFORMATION:

Catalog Number	Clip Material	Finish	Style
100 054	Spring Brass	Silver-plated	Ear
100 056	Spring Brass	Tin-plated	Ear

NOTE: Spring brass clips are suitable for current levels up to 10 amperes.

NOTE: Metric dimensions are shown. Inch dimensions are in parentheses.



Fuse Size	A Dim.
5mm x 20mm	20.5 (.807")
5mm x 25mm	25.5 (1.004")
5mm x 30mm	31.0 (1.220")

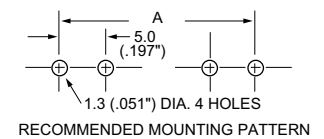
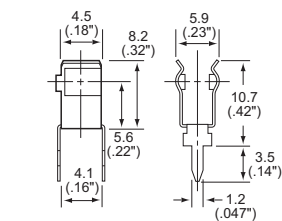

RoHS For 5mm Diameter Fuses P.C. Board Type

ORDERING INFORMATION:

Catalog Number	Clip Material	Finish	Style
0445 0001	Spring Brass	Tin-plated	Ear
0030 0210	Spring Brass	Nickel-plated	Ear
0520 0001*	Spring Brass	Silver-plated	Ear

NOTE: Spring brass clips are suitable for current levels up to 10 amperes.

* Item is UL Recognized

Fuse Size	A Dim.
5mm x 20mm	20.5 (.807")
5mm x 25mm	25.5 (1.004")
5mm x 30mm	31.0 (1.220")

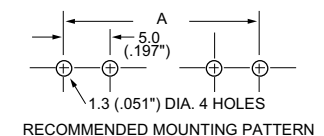
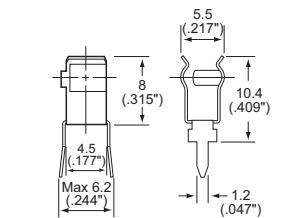

Fuse Blocks and Clips

RoHS For 5mm Diameter Fuses Automatic Insertion Type

ORDERING INFORMATION:

Catalog Number	Clip Material	Finish	Style
0111 0005MR	Phosphor Bronze	Tin-plated	Ear

Ammo Pack 1000 Pcs.

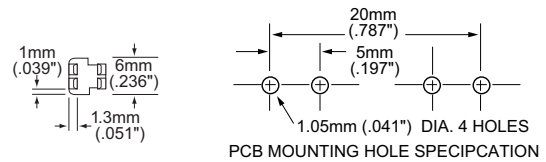
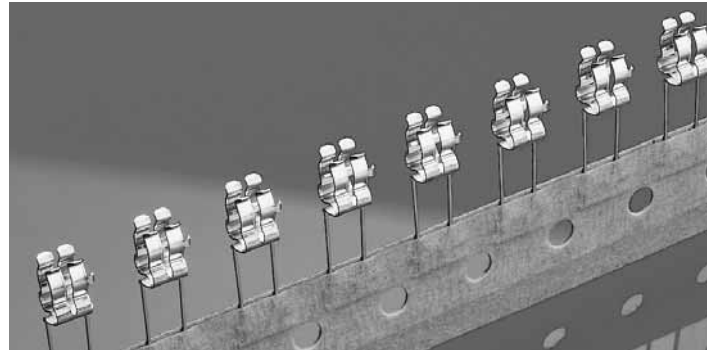
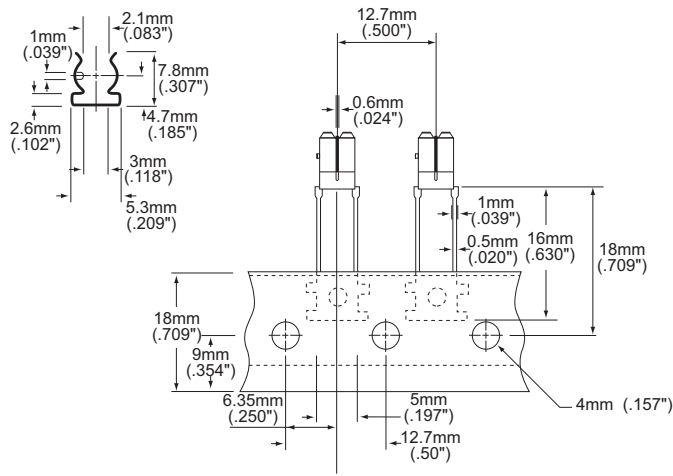

NOTE: #0111 005 phosphor bronze, tin-plated clips designed for automatic insertion are suitable for current levels up to 10 amperes.

RoHS For Midget Fuses (13/32") PC Board Mount



ELECTRICAL SPECIFICATIONS: 15A at 250VAC

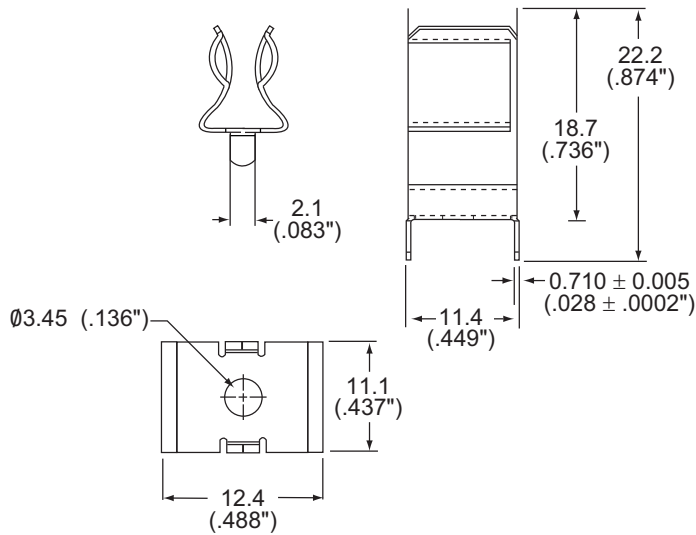

ORDERING INFORMATION:

Catalog Number	Clip Material	Finish	Style	Amp Rating	Voltage Rating
0105 0003	Spring Brass	Tin-plated	Ear	15A	250VAC
0125 0003	Beryllium Copper	Tin-plated	Ear	30A	250VAC

Looking for pricing, stock, or lifecycle information?

Click below to explore more details on WIN SOURCE:

 [View 01000056Z on WIN SOURCE](#)

 [Littelfuse Inc. Information](#)

Optimize Your Supply Chain with WIN SOURCE Solutions

-  Global Sourcing Solution
-  Obsolete Management
-  Cost Control Management
-  Shortage Management
-  Alternative Solution
-  Excess Inventory Management