



**THE DATASHEET OF
MAX5183BEEI+T**





Dual, 10-Bit, 40MHz, Current/Voltage Simultaneous-Output DACs

General Description

The MAX5180 contains two 10-bit, simultaneous-update, current-output digital-to-analog converters (DACs) designed for superior performance in communications systems requiring analog signal reconstruction with low distortion and low-power operation. The MAX5183 provides equal specifications, with on-chip precision resistors for voltage output operation. The devices are designed for 10pVs glitch operation to minimize unwanted spurious signal components at the output. An on-board 1.2V bandgap circuit provides a well-regulated, low-noise reference that can be disabled for external reference operation.

The MAX5180/MAX5183 are designed to provide a high level of signal integrity for the least amount of power dissipation. The DACs operate from a single supply of 2.7V to 3.3V. Additionally, these DACs have three modes of operation: normal, low-power standby, and complete shutdown, which provides the lowest possible power dissipation with 1 μ A (max) shutdown current. A fast wake-up time (0.5 μ s) from standby mode to full DAC operation conserves power by activating the DACs only when required.

The MAX5180/MAX5183 are packaged in a 28-pin QSOP and are specified for the extended (-40°C to +85°C) temperature range. For lower-resolution, dual 8-bit versions, refer to the MAX5186/MAX5189 data sheet.

Applications

Signal Reconstruction of I and Q Transmit Signals
 Digital Signal Processing
 Arbitrary Waveform Generation (AWG)
 Imaging

Features

- ◆ 2.7V to 3.3V Single-Supply Operation
- ◆ Wide Spurious-Free Dynamic Range: 70dB at $f_{OUT} = 2.2\text{MHz}$
- ◆ Fully Differential Outputs for Each DAC
- ◆ $\pm 0.5\%$ FSR Gain Mismatch
- ◆ $\pm 0.2^\circ$ Phase Mismatch
- ◆ Low-Current Standby or Full-Shutdown Modes
- ◆ Internal 1.2V Low-Noise Bandgap Reference
- ◆ Small 28-Pin QSOP Package

Ordering Information

PART	TEMP RANGE	PIN-PACKAGE
MAX5180BEEI	-40°C to +85°C	28 QSOP
MAX5183BEEI	-40°C to +85°C	28 QSOP

Pin Configuration

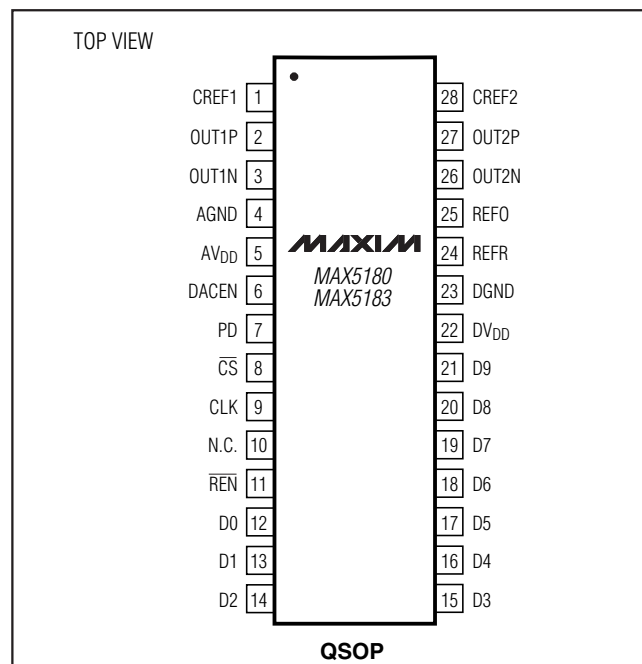

MAX5180/MAX5183

Dual, 10-Bit, 40MHz, Current/Voltage Simultaneous-Output DACs

ABSOLUTE MAXIMUM RATINGS

AV _{DD} , DV _{DD} to AGND, DGND	-0.3V to +6V	Maximum Current into Any Pin.....	50mA
Digital Inputs to DGND.....	-0.3V to +6V	Continuous Power Dissipation (T _A = +70°C)	
OUT1P, OUT1N, OUT2P, OUT2N, CREF1, CREF2 to AGND	-0.3V to +6V	28-Pin QSOP (derate 9.00mW/°C above +70°C).....	725mW
V _{REF} to AGND	-0.3V to +6V	Operating Temperature Range	
AGND to DGND.....	-0.3V to +0.3V	MAX518_BEEI.....	-40°C to +85°C
AV _{DD} to DV _{DD}	±3.3V	Storage Temperature Range	-65°C to +150°C
		Lead Temperature (soldering, 10s)	+300°C

Stresses beyond those listed under "Absolute Maximum Ratings" may cause permanent damage to the device. These are stress ratings only, and functional operation of the device at these or any other conditions beyond those indicated in the operational sections of the specifications is not implied. Exposure to absolute maximum rating conditions for extended periods may affect device reliability.

ELECTRICAL CHARACTERISTICS

(AV_{DD} = DV_{DD} = 3V ±10%, AGND = DGND = 0, f_{CLK} = 40MHz, I_{FS} = 1mA, 400Ω differential output, C_L = 5pF, T_A = T_{MIN} to T_{MAX}, unless otherwise noted. Typical values are at T_A = +25°C.)

PARAMETER	SYMBOL	CONDITIONS	MIN	TYP	MAX	UNITS
Resolution	N		10			Bits
Integral Nonlinearity	INL		-2	±0.5	+2	LSB
Differential Nonlinearity	DNL	Guaranteed monotonic	-1	±0.5	+1	LSB
Zero-Scale Error		MAX5180	-2		+2	LSB
		MAX5183	-8		+8	
Full-Scale Error		(Note 1)	-40	±15	+40	LSB
DYNAMIC PERFORMANCE						
Output Settling Time		To ±0.5LSB error band		25		ns
Glitch Impulse				10		pV-s
Spurious-Free Dynamic Range to Nyquist	SFDR	f _{CLK} = 40MHz	f _{OUT} = 550kHz		72	dBc
			f _{OUT} = 2.2MHz, T _A = +25°C	57	70	
Total Harmonic Distortion to Nyquist	THD	f _{CLK} = 40MHz	f _{OUT} = 550kHz		-70	dBc
			f _{OUT} = 2.2MHz, T _A = +25°C		-68	
Signal-to-Noise Ratio to Nyquist	SNR	f _{CLK} = 40MHz	f _{OUT} = 550kHz		61	dB
			f _{OUT} = 2.2MHz, T _A = +25°C		59	
DAC-to-DAC Output Isolation		f _{OUT} = 2.2MHz		-60		dB
Clock and Data Feedthrough		All 0s to all 1s		50		nVs
Output Noise				10		pA/√Hz
Gain Mismatch Between DAC Outputs		f _{OUT} = 2.2MHz, T _A = +25°C		±0.5	±1	%FSR
Phase Mismatch Between DAC Outputs		f _{OUT} = 2.2MHz		±0.15		degrees
ANALOG OUTPUT						
Full-Scale Output Voltage	V _{FS}			400		mV
Voltage Compliance of Output			-0.3		0.8	V
Output Leakage Current		DACEN = 0, MAX5180 only	-1		1	μA
Full-Scale Output Current	I _{FS}	MAX5180 only	0.5	1	1.5	mA
DAC External Output Resistor Load	R _L	MAX5180 only		400		Ω

Dual, 10-Bit, 40MHz, Current/Voltage Simultaneous-Output DACs

MAX5180/MAX5183

ELECTRICAL CHARACTERISTICS (continued)

(AVDD = DVDD = 3V ±10%, AGND = DGND = 0, fCLK = 40MHz, IFS = 1mA, 400Ω differential output, CL = 5pF, TA = TMIN to TMAX, unless otherwise noted. Typical values are at TA = +25°C.)

PARAMETER	SYMBOL	CONDITIONS	MIN	TYP	MAX	UNITS
REFERENCE						
Output Voltage Range	VREF		1.12	1.2	1.28	V
Output Voltage Temperature Drift	TCVREF			50		ppm/°C
Reference Output Drive Capability	IREFOUT			10		μA
Reference Supply Rejection				0.5		mV/V
Current Gain (IFS / IREF)				8		mA/mA
POWER REQUIREMENTS						
Analog Power-Supply Voltage	AVDD		2.7		3.3	V
Analog Supply Current	I _{AVDD}	PD = 0, DACEN = 1, digital inputs at 0 or DVDD		2.7	5.0	mA
Digital Power-Supply Voltage	DVDD		2.7		3.3	V
Digital Supply Current	I _{DVDD}	PD = 0, DACEN = 1, digital inputs at 0 or DVDD		4.2	5.0	mA
Standby Current	I _{STANDBY}	PD = 0, DACEN = 0, digital inputs at 0 or DVDD		1.0	1.5	mA
Shutdown Current	I _{SHDN}	PD = 1, DACEN = X, digital inputs at 0 or DVDD (X = don't care)		0.5	1.0	μA
LOGIC INPUTS AND OUTPUTS						
Digital Input Voltage High	V _{IH}		2			V
Digital Input Voltage Low	V _{IL}				0.8	V
Digital Input Current	I _{IN}	V _{IN} = 0 or DVDD			±1	μA
Digital Input Capacitance	C _{IN}			10		pF
TIMING CHARACTERISTICS						
DAC1 DATA to CLK Rise Setup Time	t _{DS1}		10			ns
DAC2 DATA to CLK Fall Setup Time	t _{DS2}		10			ns
DAC1 CLK Rise to DATA Hold Time	t _{DH1}		0			ns
DAC2 CLK Fall to DATA Hold Time	t _{DH2}		0			ns
$\overline{\text{CS}}$ Fall to CLK Rise Time				5		ns
$\overline{\text{CS}}$ Fall to CLK Fall Time				5		ns
DACEN Rise Time to V _{OUT_}				0.5		μs
PD Fall Time to V _{OUT_}				50		μs
Clock Period	t _{CP}		25			ns
Clock High Time	t _{CH}		10			ns
Clock Low Time	t _{CL}		10			ns

Dual, 10-Bit, 40MHz, Current/Voltage Simultaneous-Output DACs

Typical Operating Characteristics

(AVDD = DVDD = 3V, AGND = DGND = 0, 400Ω differential output, IFS = 1mA, CL = 5pF, TA = +25°C, unless otherwise noted.)

INTEGRAL NONLINEARITY vs. INPUT CODE

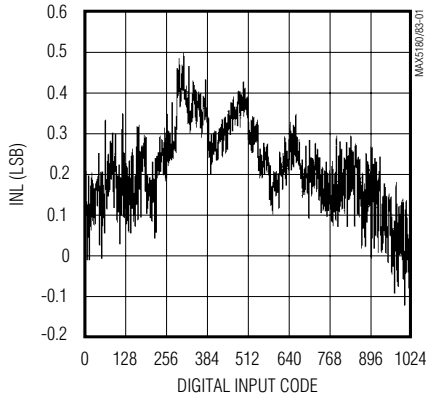

DIFFERENTIAL NONLINEARITY vs. INPUT CODE

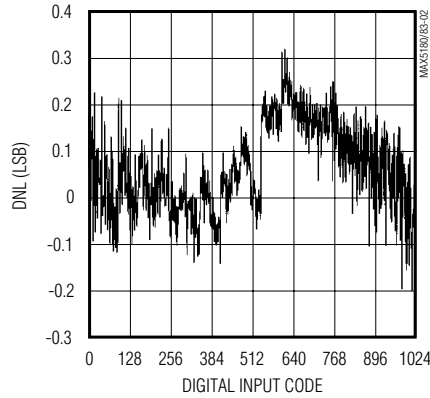

ANALOG SUPPLY CURRENT vs. SUPPLY VOLTAGE

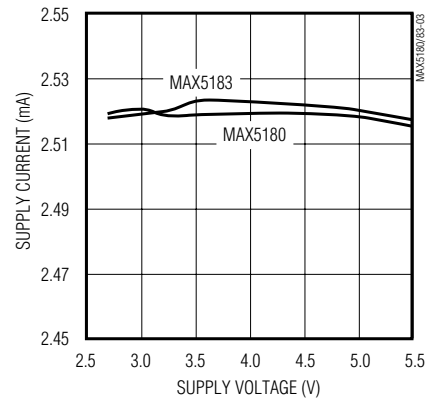

ANALOG SUPPLY CURRENT vs. TEMPERATURE

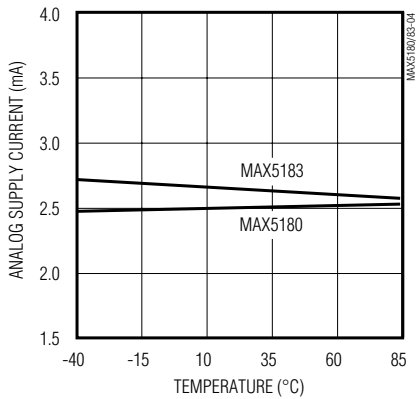

DIGITAL SUPPLY CURRENT vs. SUPPLY VOLTAGE

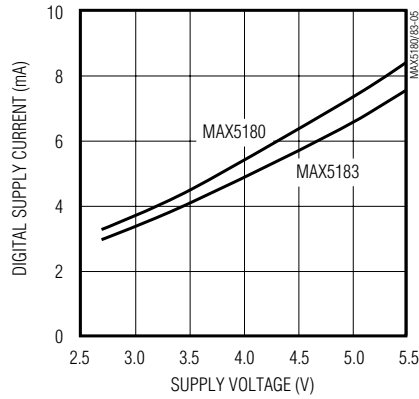

DIGITAL SUPPLY CURRENT vs. TEMPERATURE

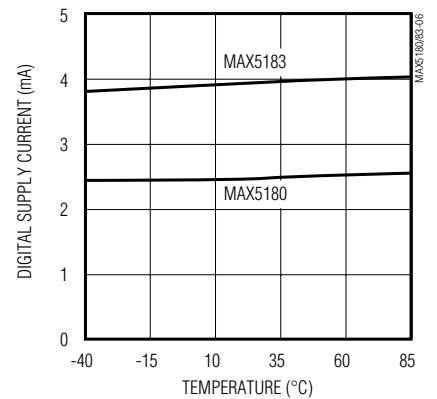

STANDBY CURRENT vs. SUPPLY VOLTAGE

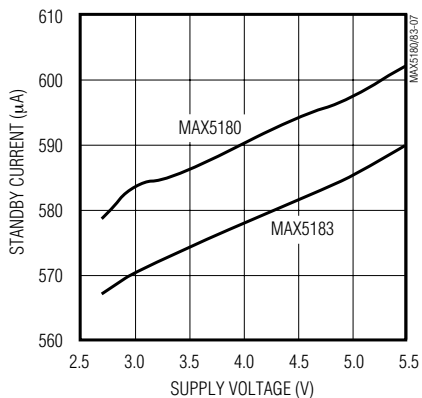

STANDBY CURRENT vs. TEMPERATURE

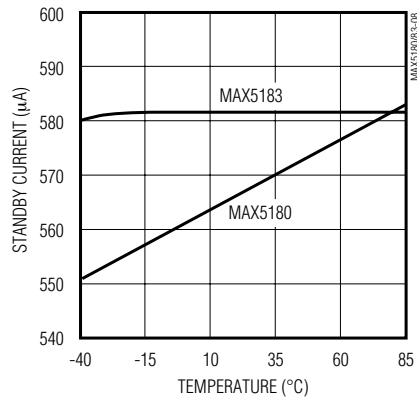

SHUTDOWN CURRENT vs. SUPPLY VOLTAGE

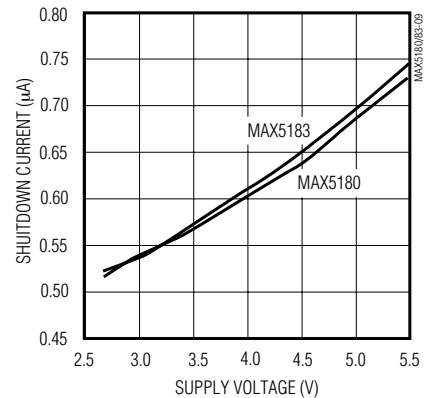

Dual, 10-Bit, 40MHz, Current/Voltage Simultaneous-Output DACs

Typical Operating Characteristics (continued)

($V_{DD} = DV_{DD} = 3V$, $AGND = DGND = 0$, 400Ω differential output, $I_{FS} = 1mA$, $C_L = 5pF$, $T_A = +25^\circ C$, unless otherwise noted.)

MAX5180/MAX5183

INTERNAL REFERENCE VOLTAGE vs. SUPPLY VOLTAGE

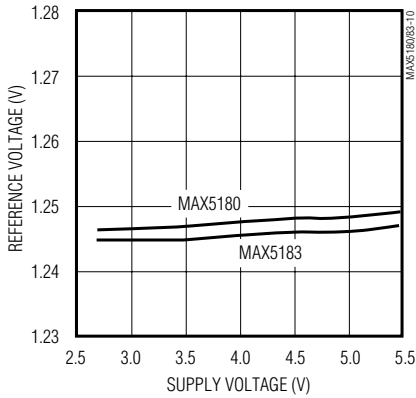

INTERNAL REFERENCE VOLTAGE vs. TEMPERATURE

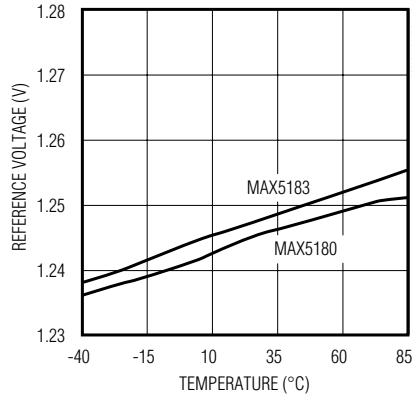

OUTPUT CURRENT vs. REFERENCE CURRENT

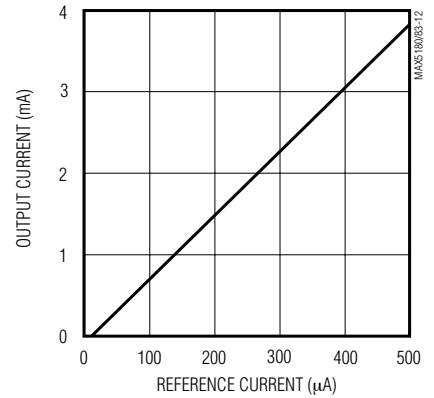

DYNAMIC RESPONSE RISE TIME

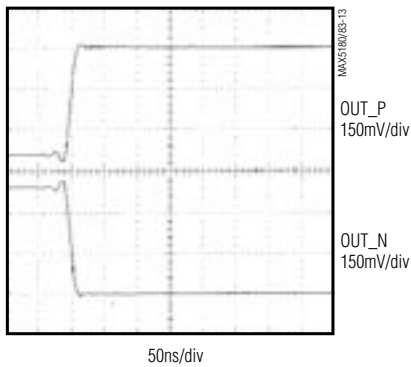

DYNAMIC RESPONSE FALL TIME

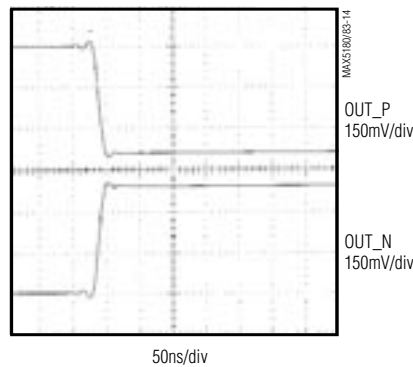

SETTLING TIME

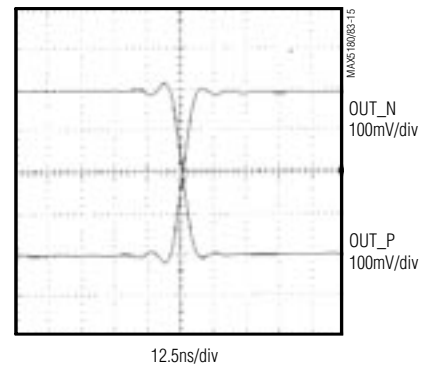

FFT PLOT, DAC1

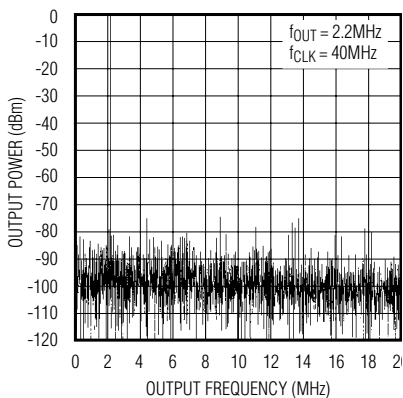

FFT PLOT, DAC2

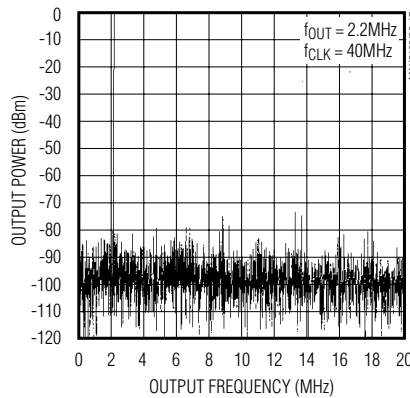

SPURIOUS-FREE DYNAMIC RANGE vs. CLOCK FREQUENCY

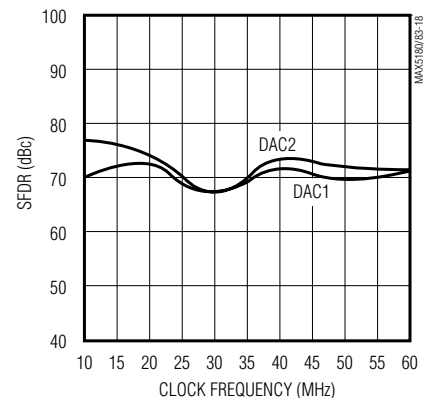

Dual, 10-Bit, 40MHz, Current/Voltage Simultaneous-Output DACs

Typical Operating Characteristics (continued)

($V_{DD} = DV_{DD} = 3V$, $AGND = DGND = 0$, 400Ω differential output, $I_{FS} = 1mA$, $C_L = 5pF$, $T_A = +25^\circ C$, unless otherwise noted.)

SPURIOUS-FREE DYNAMIC RANGE vs. OUTPUT FREQUENCY AND CLOCK FREQUENCY, DAC1

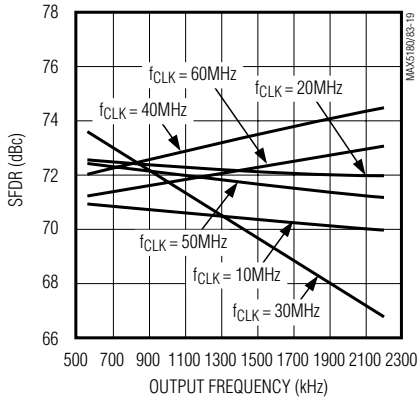

SPURIOUS-FREE DYNAMIC RANGE vs. OUTPUT FREQUENCY AND CLOCK FREQUENCY, DAC2

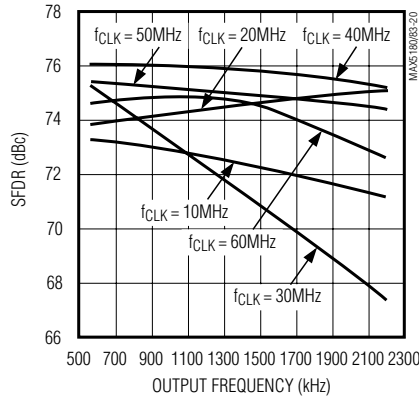

SIGNAL-TO-NOISE PLUS DISTORTION vs. OUTPUT FREQUENCY

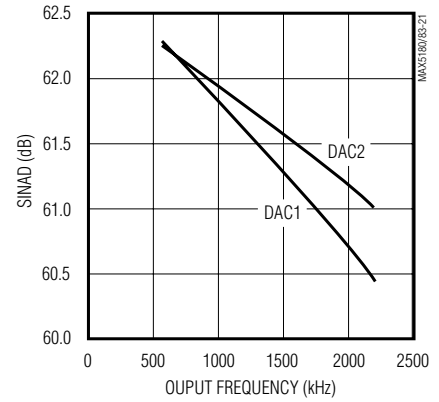

SPURIOUS-FREE DYNAMIC RANGE vs. OUTPUT FREQUENCY

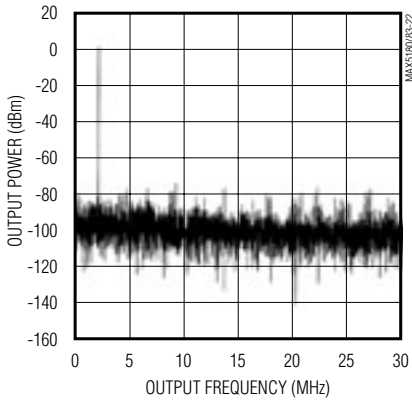

MULTITONE SPURIOUS-FREE DYNAMIC RANGE vs. OUTPUT FREQUENCY

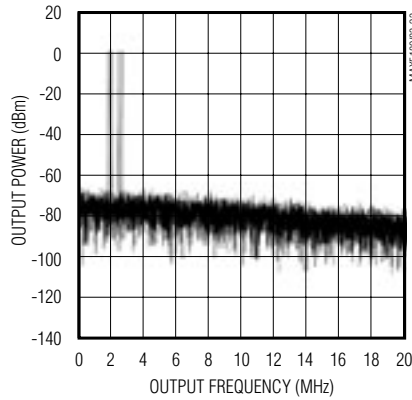

SPURIOUS-FREE DYNAMIC RANGE vs. FULL-SCALE OUTPUT CURRENT

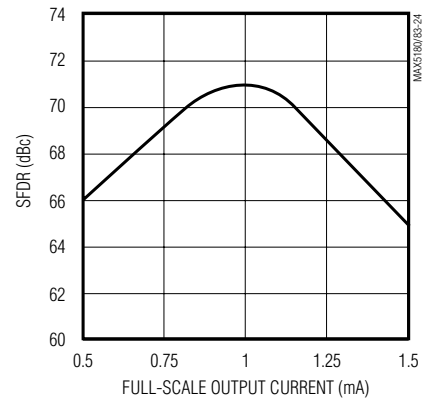

Dual, 10-Bit, 40MHz, Current/Voltage Simultaneous-Output DACs

Pin Description

MAX5180/MAX5183

PIN	NAME	FUNCTION
1	CREF1	Reference Bias Bypass, DAC1
2	OUT1P	Positive Analog Output, DAC1. Current output for MAX5180; voltage output for MAX5183.
3	OUT1N	Negative Analog Output, DAC1. Current output for MAX5180; voltage output for MAX5183.
4	AGND	Analog Ground
5	AV _{DD}	Analog Positive Supply, 2.7V to 3.3V
6	DACEN	DAC Enable, Digital Input 0: Enter DAC standby mode with PD = DGND 1: Power-up DAC with PD = DGND X: Enter shutdown mode with PD = DV _{DD} (X = don't care)
7	PD	Power-Down Select 0: Enter DAC standby mode (DACEN = DGND) or power-up DAC (DACEN = DV _{DD}) 1: Enter shutdown mode.
8	$\overline{\text{CS}}$	Active-Low Chip Select
9	CLK	Clock Input
10	N.C.	No Connect. Do not connect to this pin.
11	$\overline{\text{REN}}$	Active-Low Reference Enable. Connect to DGND to activate on-chip 1.2V reference.
12	D0	Data Bit D0 (LSB)
13–20	D1–D8	Data Bits D1–D8
21	D9	Data Bit D9 (MSB)
22	DV _{DD}	Digital Supply, 2.7V to 3.3V
23	DGND	Digital Ground
24	REFR	Reference Input
25	REFO	Reference Output
26	OUT2N	Negative Analog Output, DAC2. Current output for MAX5180; voltage output for MAX5183.
27	OUT2P	Positive Analog Output, DAC2. Current output for MAX5180; voltage output for MAX5183.
28	CREF2	Reference Bias Bypass, DAC2

Dual, 10-Bit, 40MHz, Current/Voltage Simultaneous-Output DACs

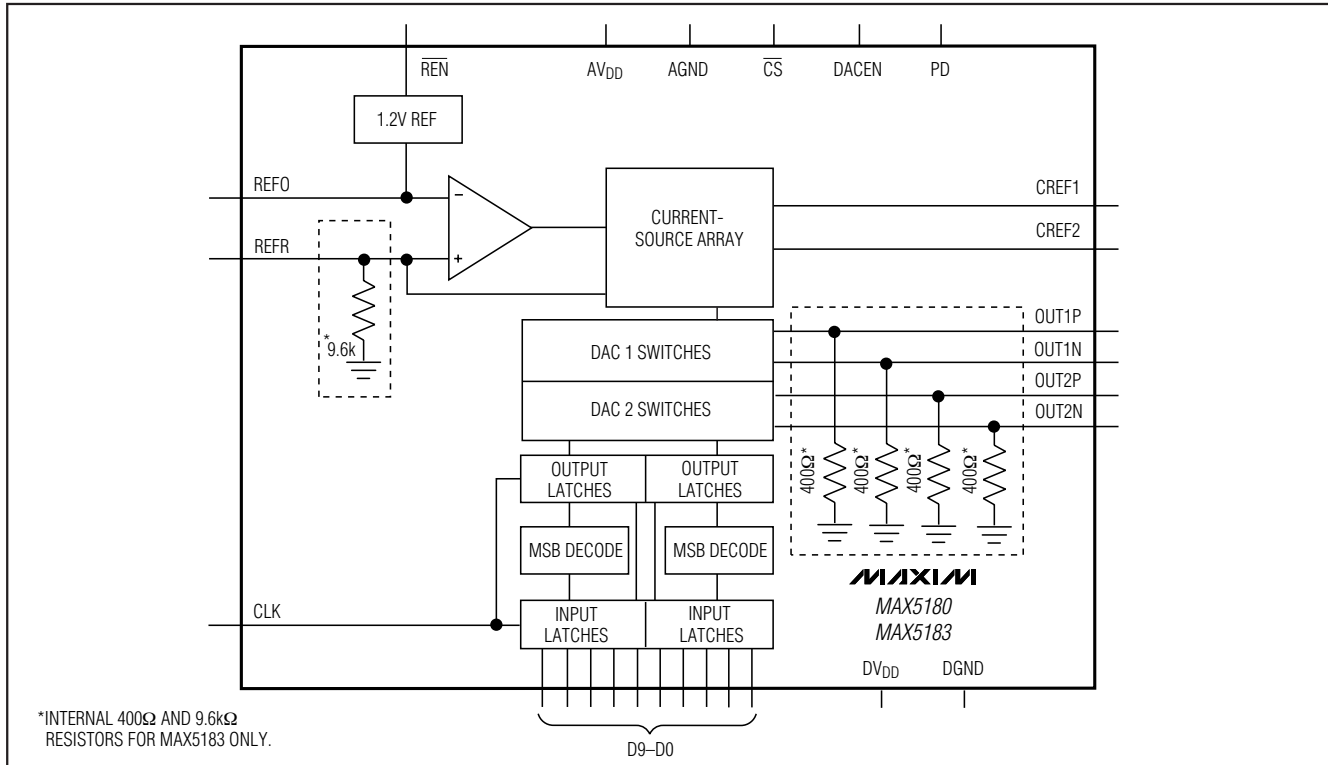

Figure 1. Functional Diagram

Detailed Description

The MAX5180/MAX5183 are dual, 10-bit digital-to-analog converters (DACs) capable of operating with clock speeds up to 40MHz. Each of these dual converters consists of separate input and DAC registers, followed by a current source array capable of generating up to 1.5mA full-scale output current (Figure 1). An integrated 1.2V voltage reference and control amplifier determine the data converters' full-scale output currents/voltages. Careful reference design ensures close gain matching and excellent drift characteristics. The MAX5183's voltage output operation features matched 400Ω on-chip resistors that convert the current array current into a voltage.

Internal Reference and Control Amplifier

The MAX5180/MAX5183 provide an integrated 50ppm/°C, 1.2V, low-noise bandgap reference that can be disabled and overridden by an external reference voltage. REFO serves either as an external reference input or an integrated reference output. If $\overline{\text{REN}}$ is connected to AGND, the internal reference is selected and REFO provides a 1.2V output. Due to its limited 10μA

output drive capability, REFO must be buffered with an external amplifier, if heavier loading is required.

The MAX5180/MAX5183 also employ a control amplifier designed to simultaneously regulate the full-scale output current (I_{FS}) for both outputs of the devices. The output current is calculated as follows:

$$I_{\text{FS}} = 8 \times I_{\text{REF}}$$

where I_{REF} is the reference output current ($I_{\text{REF}} = V_{\text{REFO}}/R_{\text{SET}}$) and I_{FS} is the full-scale output current. R_{SET} is the reference resistor that determines the amplifier's output current on the MAX5180 (Figure 2). This current is mirrored into the current-source array where it is equally distributed between matched current segments and summed to valid output current readings for the DACs.

The MAX5183 converts each output current (DAC1 and DAC2) into an output voltage (V_{OUT1} , V_{OUT2}) with two internal, ground-referenced 400Ω load resistors. Using the internal 1.2V reference voltage, the MAX5183's integrated reference output current resistor ($R_{\text{SET}} = 9.6\text{k}\Omega$) sets I_{REF} to 125μA and I_{FS} to 1mA.

Dual, 10-Bit, 40MHz, Current/Voltage Simultaneous-Output DACs

External Reference

To disable the MAX5180/MAX5183's internal reference, connect $\overline{\text{REN}}$ to AV_{DD} . A temperature-stable, external reference may now be applied to drive the REFO pin to set the full-scale output (Figure 3). Choose a reference capable of supplying at least $150\mu\text{A}$ to drive the bias circuit that generates the cascode current for the current array. For improved accuracy and drift performance, choose a fixed output voltage reference such as the 1.2V, 25ppm/ $^{\circ}\text{C}$ MAX6520 bandgap reference.

Standby Mode

To enter the lower power standby mode, connect digital inputs PD and DACEN to DGND. In standby, both the reference and the control amplifier are active with the current array inactive. To exit this condition, DACEN must be pulled high with PD held at DGND. Both the

MAX5180 and MAX5183 typically require $50\mu\text{s}$ to wake up and allow both the outputs and the reference to settle.

Shutdown Mode

For lowest power consumption, the MAX5180/MAX5183 provide a power-down mode in which the reference, control amplifier, and current array are inactive and the DAC supply current is reduced to $1\mu\text{A}$. To enter this mode, connect PD to DV_{DD} . To return to active mode, connect PD to DGND and DACEN to DV_{DD} . Table 1 lists the power-down mode selection. About $50\mu\text{s}$ are required for the parts to leave shutdown mode and settle to their outputs' values prior to shutdown.

Timing Information

The MAX5180/MAX5183 dual DACs write to their outputs simultaneously (Figure 4). On the falling edge of

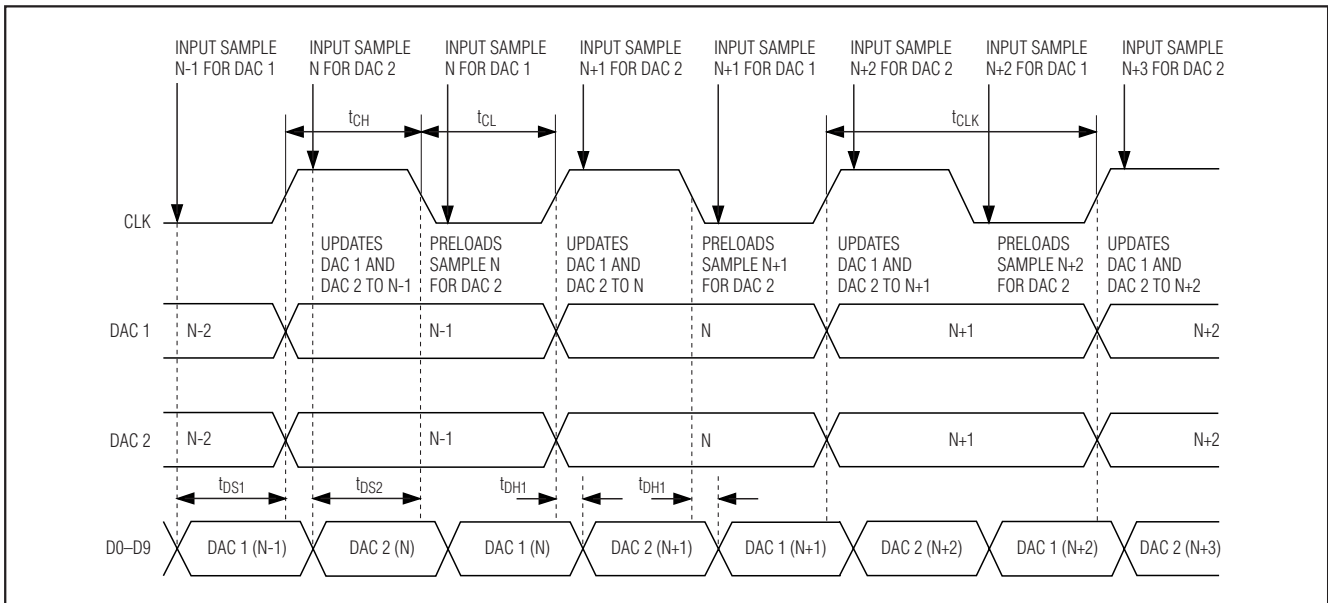

Figure 4. Timing Diagram

Table 1. Power-Down Mode Selection

PD (POWER-DOWN SELECT)	DACEN (DAC ENABLE)	POWER-DOWN MODE	OUTPUT STATE	
0	0	Standby	MAX5180	High-Z
			MAX5183	AGND
0	1	Wake-Up	Last state prior to standby mode	
1	X	Shutdown	MAX5180	High-Z
			MAX5183	AGND

X = Don't care

Dual, 10-Bit, 40MHz, Current/Voltage Simultaneous-Output DACs

the clock, the input data for DAC2 is preloaded into a latch. On the rising edge of the clock, input data for DAC1 is loaded to the DAC1 register, and the preloaded DAC2 data in the latch is loaded to the DAC2 register.

Outputs

The MAX5180 outputs are designed to supply full-scale output currents of 1mA into 400Ω loads in parallel with a capacitive load of 5pF. The MAX5183 features integrated 400Ω resistors that restore the array currents to proportional, differential voltages of 400mV. These differential output voltages can then be used to drive a balun transformer or a low-distortion, high-speed operational amplifier to convert the differential voltage into a single-ended voltage.

Applications Information

Static and Dynamic Performance Definitions

Integral Nonlinearity (INL)

Integral nonlinearity is the deviation of the values on an actual transfer function from either a best straight-line fit (closest approximation to the actual transfer curve) or a line drawn between the end points of the transfer function, once offset and gain errors have been nullified. The MAX5180/MAX5183 use a straight-line end-point fit for INL (and DNL) and the deviations are measured at every individual step.

Differential Nonlinearity (DNL)

Differential nonlinearity is the difference between an actual step height and the ideal value of 1 LSB. A DNL error specification no more negative than -1 LSB guarantees a monotonic transfer function.

Offset Error

The offset error is the difference between the ideal and the actual offset current/voltage. For the MAX5180/MAX5183, the offset error is the midpoint value of the transfer function determined by the end points of a straight-line end-point fit. This error affects all codes by the same amount.

Gain Error

Gain error is the difference between the ideal and the actual output value range. This range represents the output when all digital inputs are set to 1 minus the output when all digital inputs are set to zero.

Glitch Impulse

A glitch is generated when a DAC switches between two codes. The largest glitch is usually generated

around the midscale transition when the input pattern transitions from 011...111 to 100...000. This occurs due to timing variations between the bits. The glitch impulse is found by integrating the voltage of the glitch at the midscale transition over time. The glitch impulse is usually specified in pV-s.

Settling Time

The settling time is the amount of time required from the start of a transition until the DAC output settles its new output value to within the converter's specified accuracy.

Digital Feedthrough

Digital feedthrough is the noise generated on a DAC's output when any digital input transitions. Proper board layout and grounding will significantly reduce this noise, but there will always be some feedthrough caused by the DAC itself.

Total Harmonic Distortion

Total harmonic distortion (THD) is the ratio of the RMS sum of the input signal's first four harmonics to the fundamental itself. This is expressed as:

$$\text{THD} = 20 \times \log \left(\frac{\sqrt{V_2^2 + V_3^2 + V_4^2 + V_5^2}}{V_1} \right)$$

where V_1 is the fundamental amplitude, and V_2 through V_5 are the amplitudes of the 2nd- through 5th-order harmonics.

Spurious-Free Dynamic Range (SFDR)

SFDR is the ratio of RMS amplitude of the carrier frequency (maximum signal component) to the RMS value of the next-largest noise or harmonic distortion component. SFDR is usually measured in dBc with respect to the carrier frequency amplitude or in dBFS with respect to the DAC's full-scale range. Depending on its test condition, SFDR is observed within a predefined window or to Nyquist. In the case of the MAX5180/MAX5183, the SFDR performance is measured for a 0dBFS output amplitude and analyzed within the Nyquist window.

Differential to Single-Ended Conversion

The MAX4108 low-distortion, high-input bandwidth amplifier may be used to generate a voltage from the array current output of the MAX5180. The differential voltage across OUT1P (or OUT2P) and OUT1N (or OUT2N) is converted into a single-ended voltage by designing an appropriate operational amplifier configuration (Figure 5).

Dual, 10-Bit, 40MHz, Current/Voltage Simultaneous-Output DACs

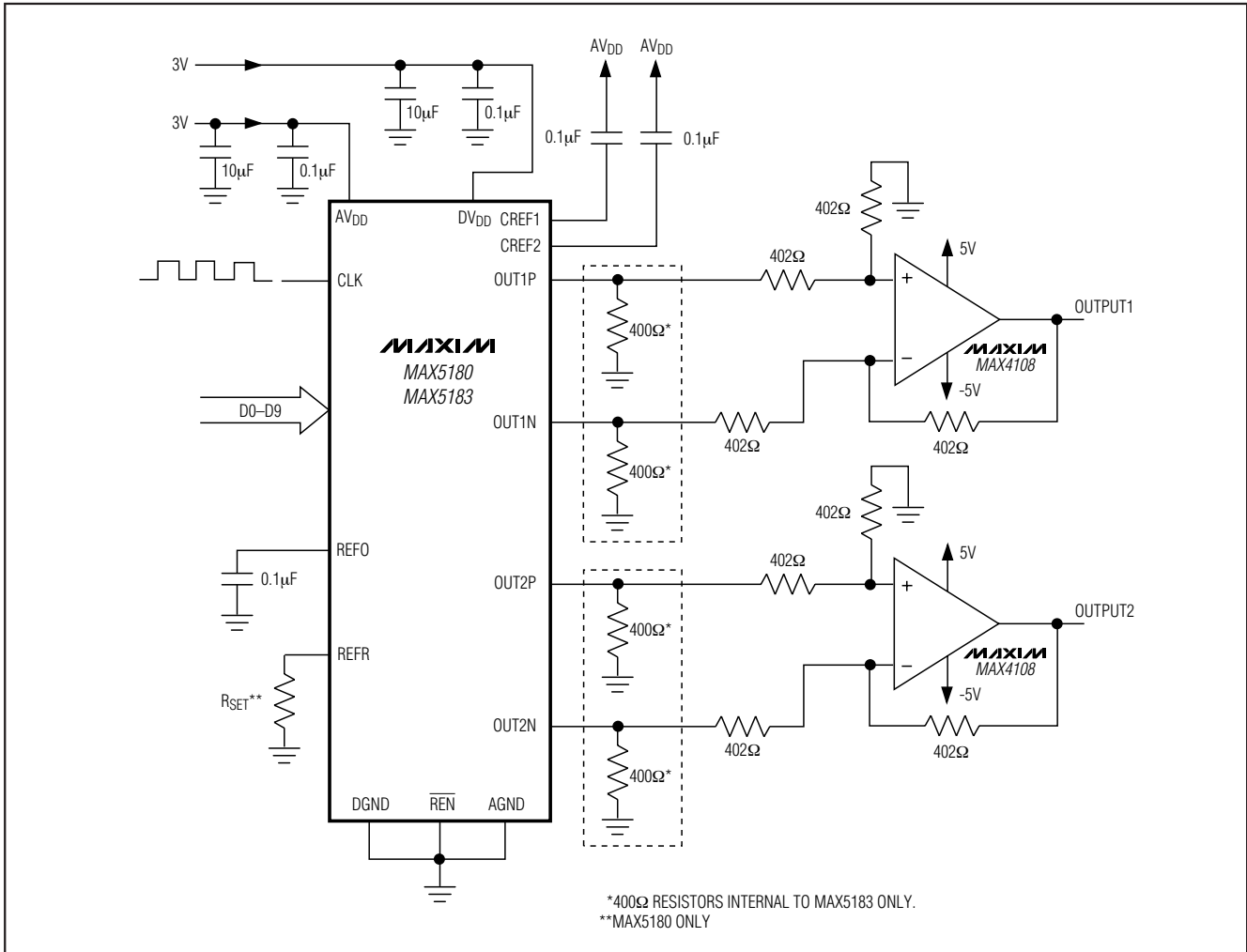

Figure 5. Differential to Single-Ended Conversion Using a Low-Distortion Amplifier

I/Q Reconstruction in a QAM Application

The MAX5180/MAX5183's low-distortion supports analog reconstruction of in-phase (I) and quadrature (Q) carrier components typically used in QAM (quadrature amplitude modulation) architectures where I and Q data are interleaved on a common data bus. A QAM signal is a carrier frequency that is both amplitude and phase modulated, and is created by summing two independently modulated carriers of identical frequency but different phase (90° phase difference).

In a typical QAM application (Figure 6), the modulation occurs in the digital domain and the MAX5180/MAX5183's dual DACs may be used to reconstruct the analog I and Q components.

The I/Q reconstruction system is completed by a quadrature modulator that combines the reconstructed I and Q components with in-phase and quadrature phase carrier frequencies, then sums both outputs to provide the QAM signal.

Grounding and Power-Supply Decoupling

Grounding and power-supply decoupling strongly influence the MAX5180/MAX5183's performance. Unwanted digital crosstalk may couple through the input, reference, power-supply, and ground connections, which may affect dynamic specifications like signal-to-noise ratio or spurious-free dynamic range. In addition, electromagnetic interference (EMI) can either couple into or be generated by the MAX5180/MAX5183. Therefore,

Dual, 10-Bit, 40MHz, Current/Voltage Simultaneous-Output DACs

MAX5180/MAX5183

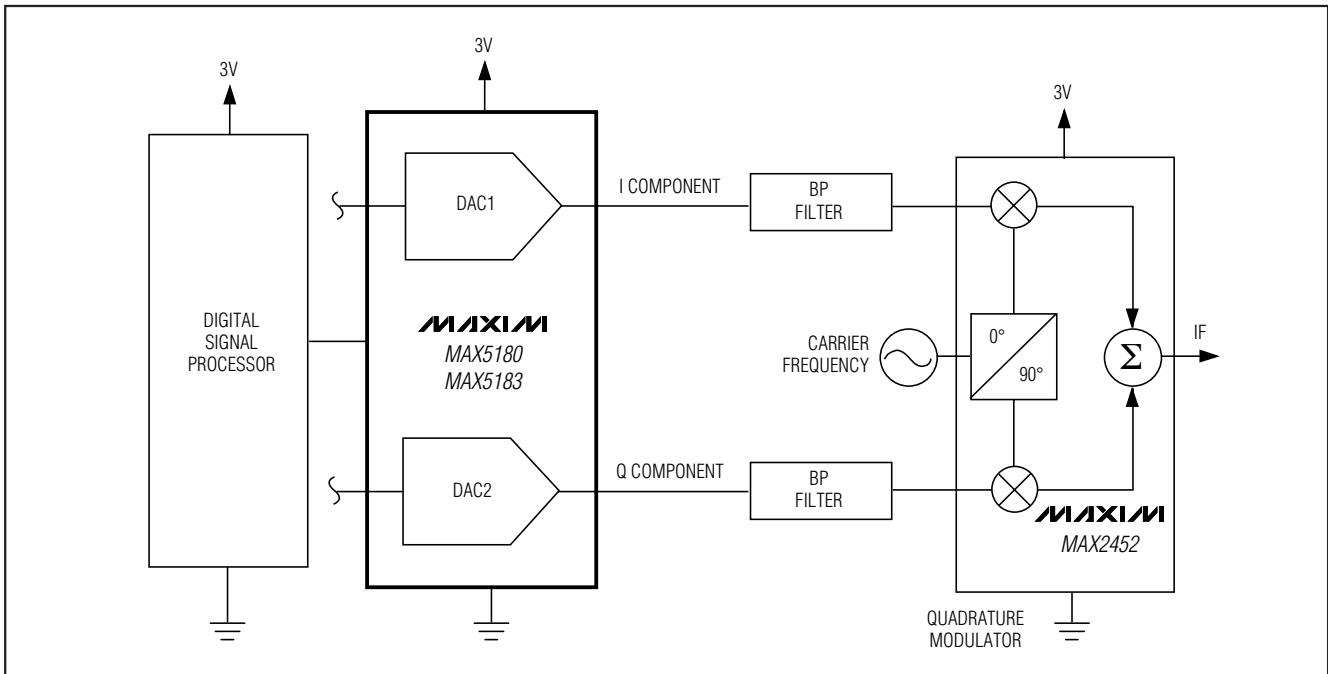

Figure 6. Using the MAX5180/MAX5183 for I/Q Signal Reconstruction

grounding and power-supply decoupling guidelines for high-speed, high-frequency applications should be closely followed.

First, a multilayer pc board with separate ground and power-supply planes is recommended. High-speed signals should be run on controlled impedance lines directly above the ground plane. Since the MAX5180/MAX5183 have separate analog and digital ground buses (AGND and DGND, respectively), the PC board should also have separate analog and digital ground sections with only one point connecting the two. Digital signals should run above the digital ground plane, and analog signals should run above the analog ground plane.

Both devices have two power-supply inputs: analog V_{DD} (AV_{DD}) and digital V_{DD} (DV_{DD}). Each AV_{DD} input should be decoupled with parallel $10\mu\text{F}$ and $0.1\mu\text{F}$ ceramic-chip capacitors. These capacitors should be as close to the pin as possible, and their opposite ends should be as close to the ground plane as possible. The

DV_{DD} pins should also have separate $10\mu\text{F}$ and $0.1\mu\text{F}$ capacitors adjacent to their respective pins. Try to minimize analog load capacitance for proper operation. For best performance, it is recommended to bypass CREF1 and CREF2 with low-ESR $0.1\mu\text{F}$ capacitors to AV_{DD} .

The power-supply voltages should also be decoupled with large tantalum or electrolytic capacitors at the point they enter the PC board. Ferrite beads with additional decoupling capacitors forming a pi network can also improve performance.

Chip Information

TRANSISTOR COUNT: 9464

SUBSTRATE CONNECTED TO AGND

Dual, 10-Bit, 40MHz, Current/Voltage Simultaneous-Output DACs

Package Information

DIM	INCHES		MILLIMETERS	
	MIN	MAX	MIN	MAX
A	.061	.068	1.55	1.73
A1	.004	.0098	0.102	0.249
A2	.055	.061	1.40	1.55
B	.008	.012	0.20	0.31
C	.0075	.0098	0.191	0.249
D	SEE VARIATIONS			
E	.150	.157	3.81	3.99
e	.025 BSC		0.635 BSC	
H	.230	.244	5.84	6.20
h	.010	.016	0.25	0.41
L	.016	.035	0.41	0.89
N	SEE VARIATIONS			
X	SEE VARIATIONS			
Y	.071	.087	1.803	2.209
α	0°	8°	0°	8°

DIM	INCHES		MILLIMETERS		N
	MIN.	MAX.	MIN.	MAX.	
D	.189	.196	4.80	4.98	16 AA
S	.0020	.0070	0.05	0.18	
X	.107	.123	2.72	3.12	
D	.337	.344	8.56	8.74	20 AB
S	.0500	.0550	1.270	1.397	
D	.337	.344	8.56	8.74	24 AC
S	.0250	.0300	0.635	0.762	
D	.386	.393	9.80	9.98	28 AD
S	.0250	.0300	0.635	0.762	
X	.271	.287	6.88	7.29	

NOTES:

1. D & E DO NOT INCLUDE MOLD FLASH OR PROTRUSIONS.
2. MOLD FLASH OR PROTRUSIONS NOT TO EXCEED .006" PER SIDE.
3. HEAT SLUG DIMENSIONS X AND Y APPLY ONLY TO 16 AND 28 LEAD POWER-QSDP PACKAGES.
4. CONTROLLING DIMENSIONS: INCHES.
5. MEETS JEDEC MD137.

QSDP/EFS

PROPRIETARY INFORMATION

TITLE: PACKAGE OUTLINE, QSDP, .150", .025" LEAD PITCH

APPROVAL	DOCUMENT CONTROL NO.	REV	1/1
	21-0055	C	

Maxim cannot assume responsibility for use of any circuitry other than circuitry entirely embodied in a Maxim product. No circuit patent licenses are implied. Maxim reserves the right to change the circuitry and specifications without notice at any time.

Looking for pricing, stock, or lifecycle information?

Click below to explore more details on WIN SOURCE:

- ⊖ [View MAX5183BEEI+T on WIN SOURCE](#)
- ⊖ [Maxim Integrated Information](#)

Optimize Your Supply Chain with WIN SOURCE Solutions

- ✓ Global Sourcing Solution
- ✓ Obsolete Management
- ✓ Cost Control Management
- ✓ Shortage Management
- ✓ Alternative Solution
- ✓ Excess Inventory Management