



**THE DATASHEET OF
AZV321KTR-E1**



**SINGLE LOW VOLTAGE RAIL-TO-RAIL
OUTPUT OPERATIONAL AMPLIFIER**

Description

The AZV321 is single low voltage (2.7V to 5.5V) operational amplifier which has rail-to-rail output swing capability. The input common-mode voltage range includes ground. The chip exhibits excellent speed-power ratio, achieving 1MHz of bandwidth and 1V/ μ s of slew rate with low supply current.

The AZV321 is built with BiCMOS process. It has bipolar input and output stages for improved noise performance, low input offset and higher output current drive.

The AZV321 is available in the package of SC-70-5, which is approximately half the size of SOT-23-5. The small package saves space on pc boards, and enables the design of small portable electronic devices. It also allows the designer to place the device closer to the signal source to reduce noise pickup and increase signal integrity.

The AZV321 is also available in standard SOT-23-5 package.

Features (For $V_{CC}=5V$ and $V_{EE}=0V$, Typical unless Otherwise Noted)

- Guaranteed 2.7V to 5.5V Performance
- No Crossover Distortion
- Gain-Bandwidth Product 1MHz
- Industrial Temperature Range: $-40^{\circ}C$ to $+85^{\circ}C$
- Low Supply Current: 130 μ A
- Rail-to-Rail Output Swing under 10k Ω Load:
 V_{OH} up to $V_{CC}-10mV$
 V_{OL} near to $V_{EE}+65mV$
- V_{CM} : $-0.1V$ to $V_{CC}-0.8V$

Pin Assignments

KS/K Package
(SC-70-5/SOT-23-5)

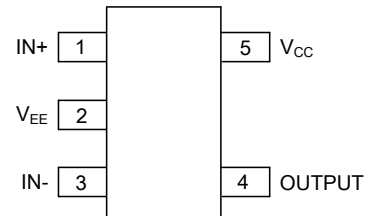

Applications

- Active Filters
- Low Power, Low Voltage Applications
- General Purpose Portable Devices
- Cellular Phone, Cordless Phone
- Battery-Powered Systems

Functional Block Diagram

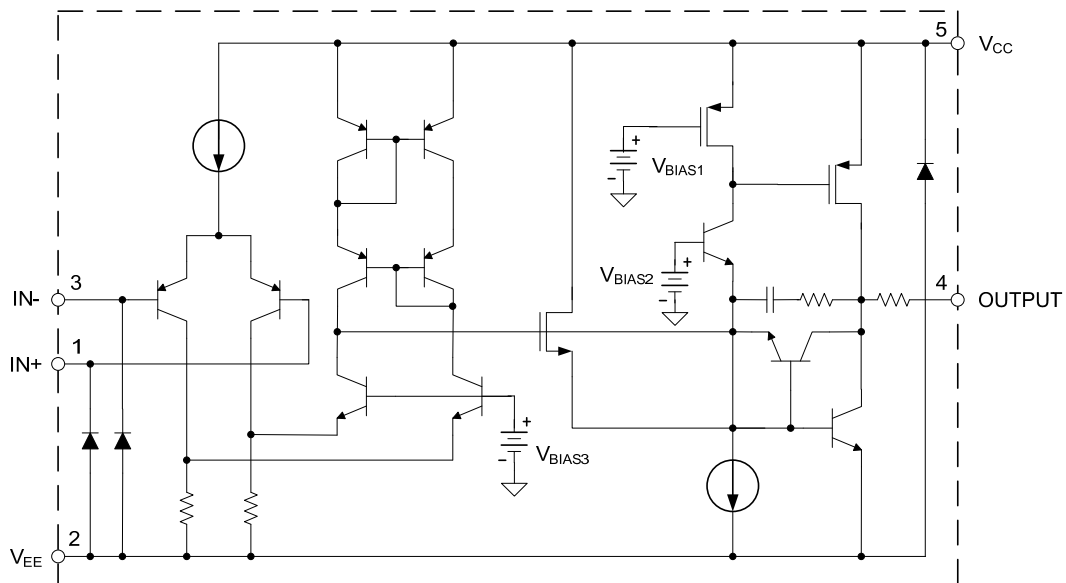

Absolute Maximum Ratings (Note 1)

Symbol	Parameter	Rating	Unit
V_{CC}	Power Supply Voltage	6	V
T_J	Operation Junction Temperature	150	°C
T_{STG}	Storage Temperature Range	-65 to 150	°C
T_{LEAD}	Lead Temperature (Soldering, 10 Seconds)	260	°C
	ESD (Machine Model)	200	V
	ESD (Human Body Model)	2000	V

Note 1: Stresses greater than those listed under “Absolute Maximum Ratings” may cause permanent damage to the device. These are stress ratings only, and functional operation of the device at these or any other conditions beyond those indicated under “Recommended Operating Conditions” is not implied. Exposure to “Absolute Maximum Ratings” for extended periods may affect device reliability.

Recommended Operating Conditions

Symbol	Parameter	Min	Max	Unit
V_{CC}	Supply Voltage	2.7	5.5	V
T_A	Ambient Operating Temperature Range	-40	85	°C

Electrical Characteristics

AZV321-2.7V Electrical Characteristics (All limits are guaranteed for $T_A=25^\circ\text{C}$, $V_{CC}=2.7\text{V}$, $V_{EE}=0\text{V}$, $V_{CM}=1.0\text{V}$, $V_O=V_{CC}/2$ and $R_L>1\text{M}\Omega$, limits in **bold types** are guaranteed for $T_A=-40^\circ\text{C}$ to 85°C , unless otherwise specified. Note 2)

Symbol	Parameter	Conditions	Min	Typ	Max	Unit
V_{IO}	Input Offset Voltage			1.7	7	mV
					9	
I_B	Input Bias Current			11	250	nA
					500	
I_{IO}	Input Offset Current			5	50	nA
					150	
V_{CM}	Input Common Mode Voltage Range	for $CMRR \geq 50\text{dB}$	-0.1		1.9	V
I_{CC}	Supply Current	$V_O=V_{CC}/2$, $A_{VCL}=1$, no load		80	170	μA
					270	
CMRR	Common Mode Rejection Ratio	$0 \leq V_{CM} \leq 1.7\text{V}$	50	65		dB
PSRR	Power Supply Rejection Ratio	$2.7\text{V} \leq V_{CC} \leq 5\text{V}$, $V_O=1\text{V}$	50	60		dB
I_{SOURCE}	Output Short Circuit Current	$V_O=0\text{V}$	5	20		mA
I_{SINK}		$V_O=2.7\text{V}$	10	30		mA
V_{OH}	Output Voltage Swing	$R_L=10\text{k}\Omega$ to 1.35V	2.60	2.69		V
V_{OL}				60	180	mV
GBWP	Gain Bandwidth Product	$C_L=200\text{pF}$		1		MHz
ϕ_M	Phase Margin			60		Deg
G_M	Gain Margin			10		dB

Note 2: Limits over the full temperature are guaranteed by design, but not tested in production.

Electrical Characteristics (Cont.)

AZV321-5V Electrical Characteristics (All limits are guaranteed for $T_A=25^\circ\text{C}$, $V_{CC}=5\text{V}$, $V_{EE}=0\text{V}$, $V_{CM}=2.0\text{V}$, $V_O=V_{CC}/2$ and $R_L>1\text{M}\Omega$, limits in **bold types** are guaranteed for $T_A=-40^\circ\text{C}$ to 85°C , unless otherwise specified. Note 2)

Symbol	Parameter	Conditions	Min	Typ	Max	Unit
V_{IO}	Input Offset Voltage			1.7	7	mV
					9	
I_B	Input Bias Current			11	250	nA
					500	
I_{IO}	Input Offset Current			5	50	nA
					150	
V_{CM}	Input Common Mode Voltage Range	for $CMRR \geq 50\text{dB}$	-0.1		4.2	V
I_{CC}	Supply Current	$V_O=V_{CC}/2$, $A_{VCL}=1$, no load		130	250	μA
					350	
G_V	Large Signal Voltage Gain	$R_L=2\text{k}\Omega$	84	100		dB
			80			
CMRR	Common Mode Rejection Ratio	$0 \leq V_{CM} \leq 4\text{V}$	50	65		dB
PSRR	Power Supply Rejection Ratio	$2.7\text{V} \leq V_{CC} \leq 5\text{V}$, $V_O=1\text{V}$, $V_{CM}=1\text{V}$	50	60		dB
I_{SOURCE}	Output Short Circuit Current	$V_O=0\text{V}$	5	60		mA
I_{SINK}		$V_O=5\text{V}$	10	160		mA
V_{OH}	Output Voltage Swing	$R_L=2\text{k}\Omega$ to 2.5V	4.7	4.96		V
			4.6			
		$R_L=10\text{k}\Omega$ to 2.5V	4.9	4.99		
			4.8			
V_{OL}	Output Voltage Swing	$R_L=2\text{k}\Omega$ to 2.5V		120	300	mV
					400	
		$R_L=10\text{k}\Omega$ to 2.5V		65	180	
					280	
SR	Slew Rate		1		$\text{V}/\mu\text{S}$	
GBWP	Gain Bandwidth Product	$C_L=200\text{pF}$		1		MHz
ϕ_M	Phase Margin			60		Deg
G_M	Gain Margin			10		dB

Note 2: Limits over the full temperature are guaranteed by design, but not tested in production.

Performance Characteristics

Supply Current vs. Supply Voltage

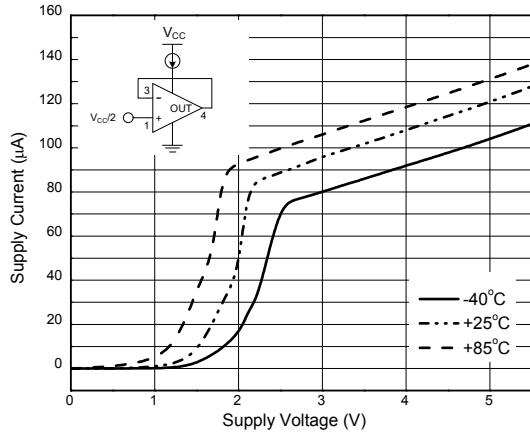

Slew Rate vs. Supply Voltage

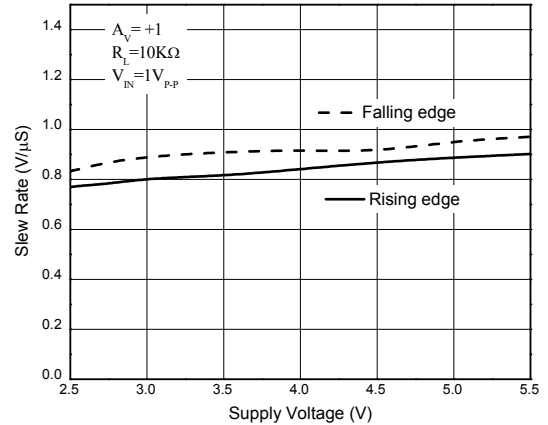

Output Source Current vs. Supply Voltage

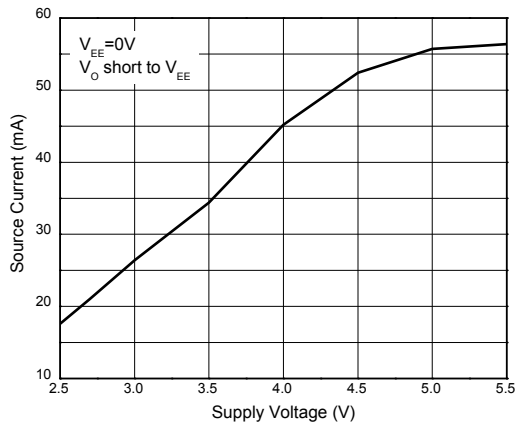

Output Sink Current vs. Supply Voltage

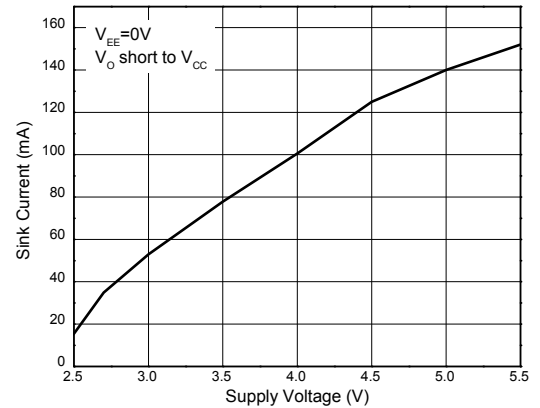

Short Circuit Current I_{SINK} vs. Temperature

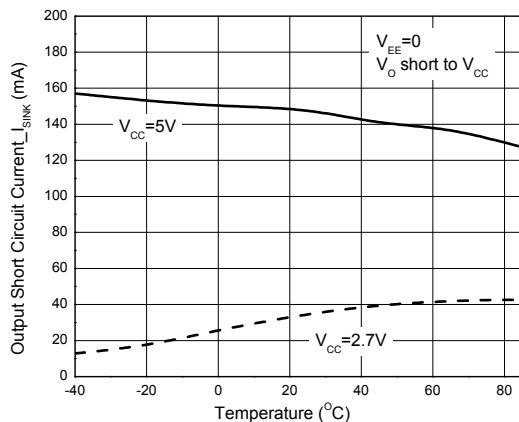

Short Circuit Current I_{SOURCE} vs. Temperature

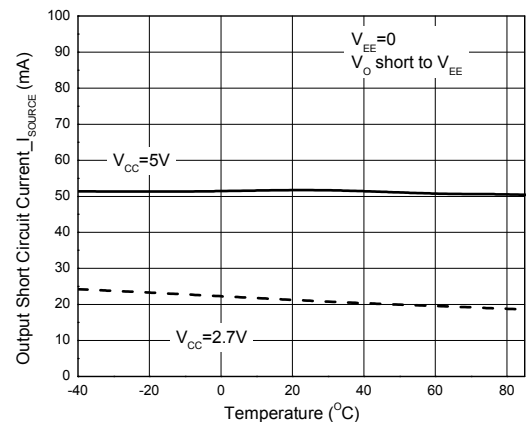

Performance Characteristics (Cont.)

Output Voltage vs. Source Current

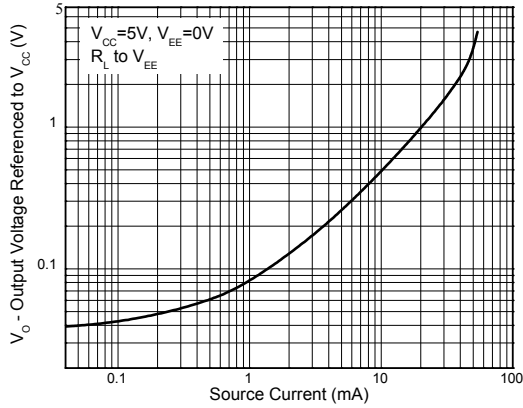

Output Voltage vs. Sink Current

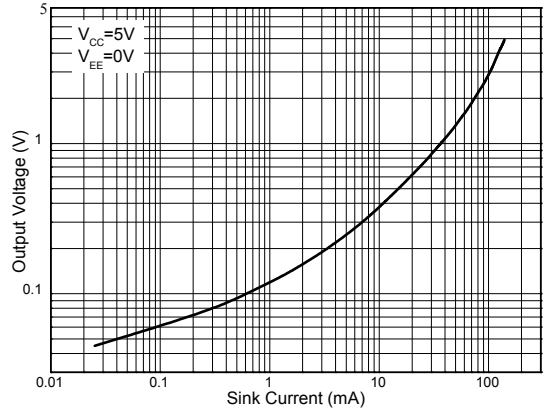

Output Voltage Swing vs. Supply Voltage

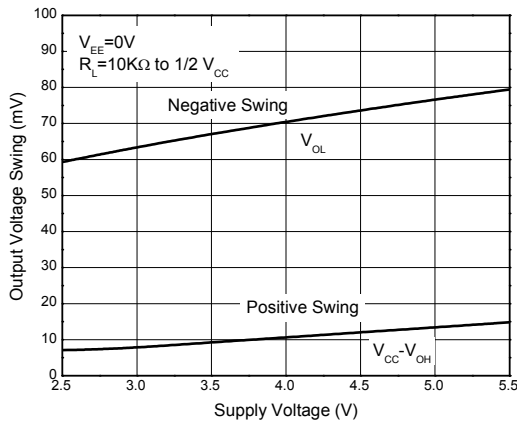

Output Voltage Swing vs. Temperature

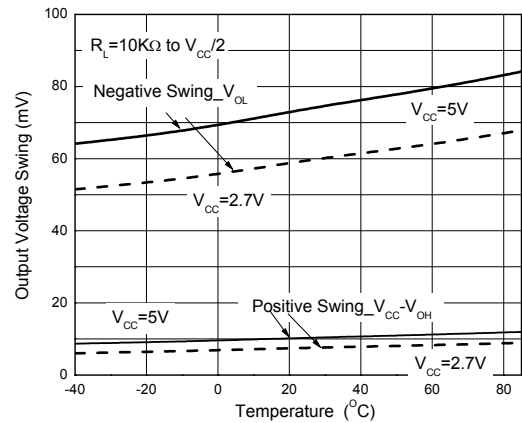

Gain and Phase vs. Frequency and Resistive Load

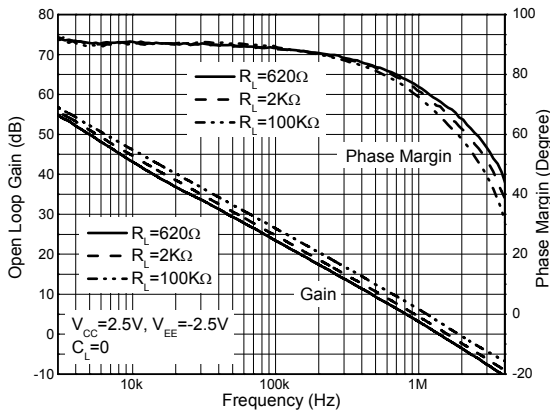

Gain and Phase vs. Frequency and Capacitive Load

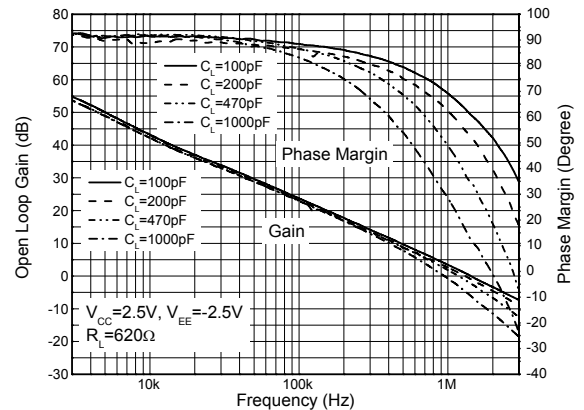

Performance Characteristics (Cont.)

Gain and Phase vs. Frequency and Capacitive Load

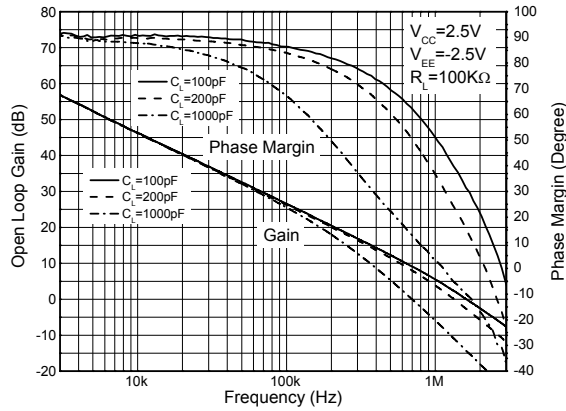

Non-Inverting Input Small Signal Pulse Response

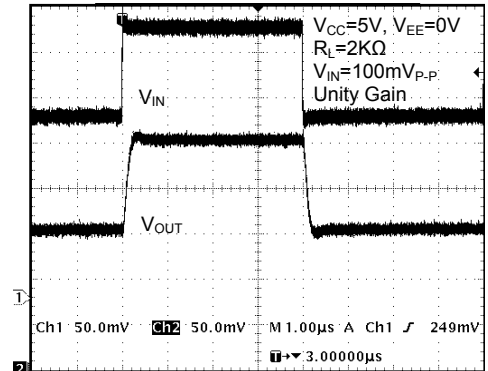

Non-Inverting Input Large Signal Pulse Response

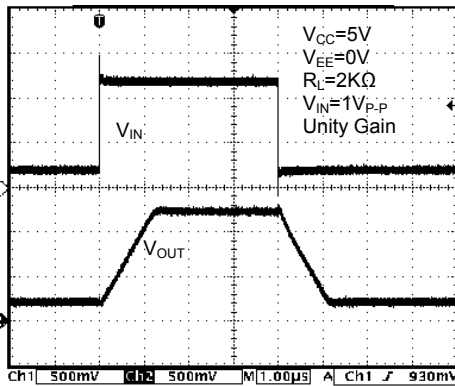

Output with Excessive Capacitive Load

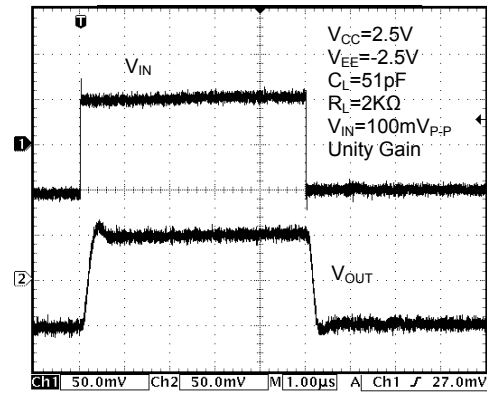

Output with Excessive Capacitive Load

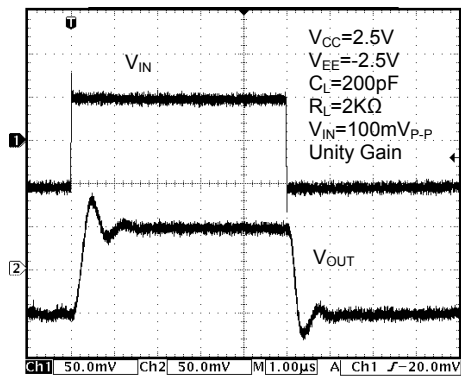

THD+N vs. Frequency

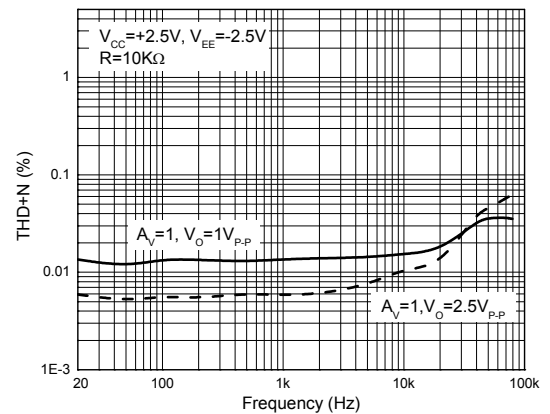

Ordering Information

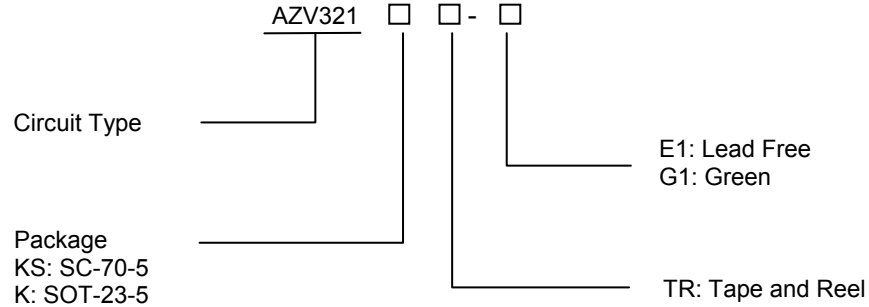

Package	Temperature Range	Part Number		Marking ID		Packing Type
		Lead Free	Green	Lead Free	Green	
SC-70-5	-40 to 85°C	AZV321KSTR-E1	AZV321KSTR-G1	21	B1	Tape & Reel
SOT-23-5		AZV321KTR-E1	AZV321KTR-G1	E6D	G6D	Tape & Reel

BCD Semiconductor's Pb-free products, as designated with "E1" suffix in the part number, are RoHS compliant. Products with "G1" suffix are available in green packages.

Package Outline Dimensions (All dimensions in mm(inch).)

SC-70-5

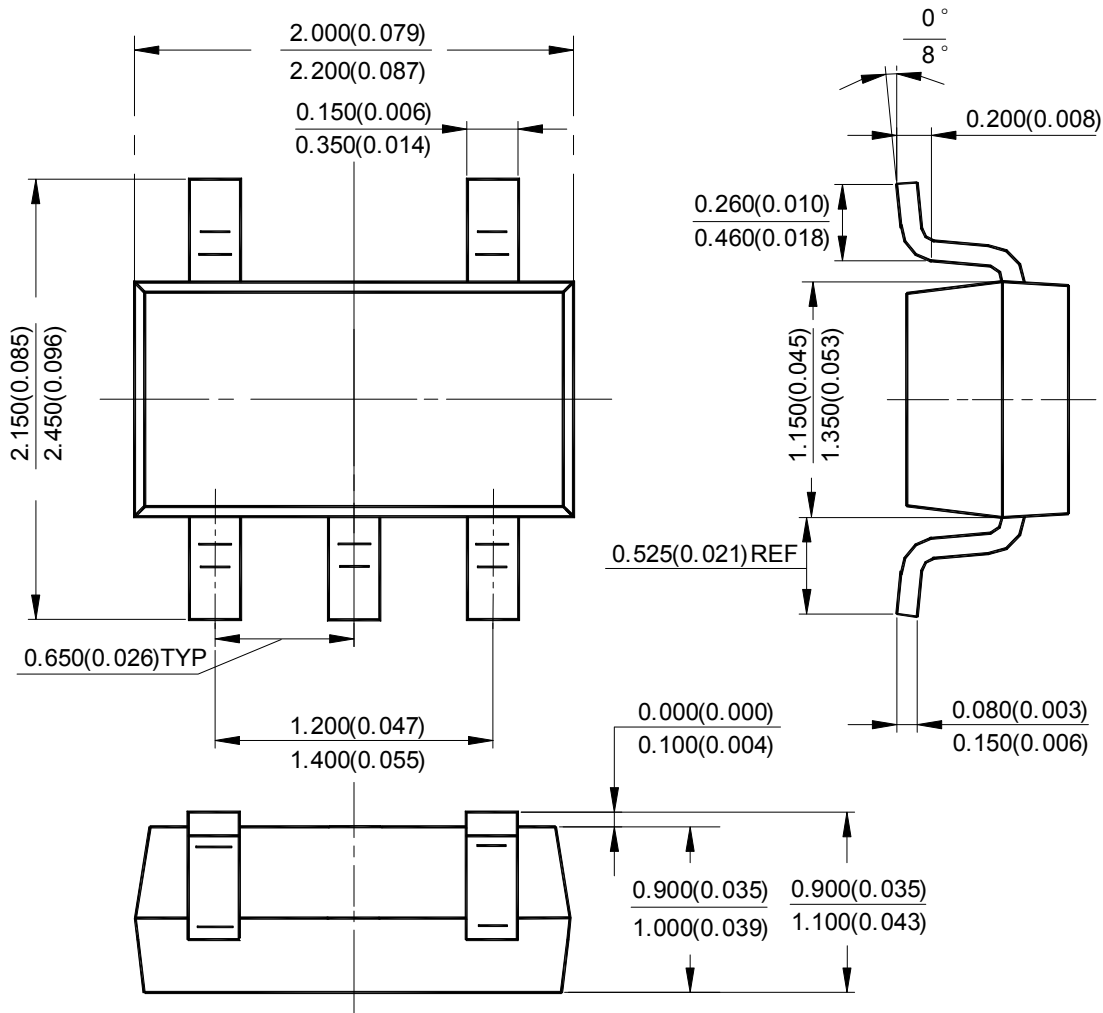

Package Outline Dimensions (Cont. All dimensions in mm(inch).)

SOT-23-5

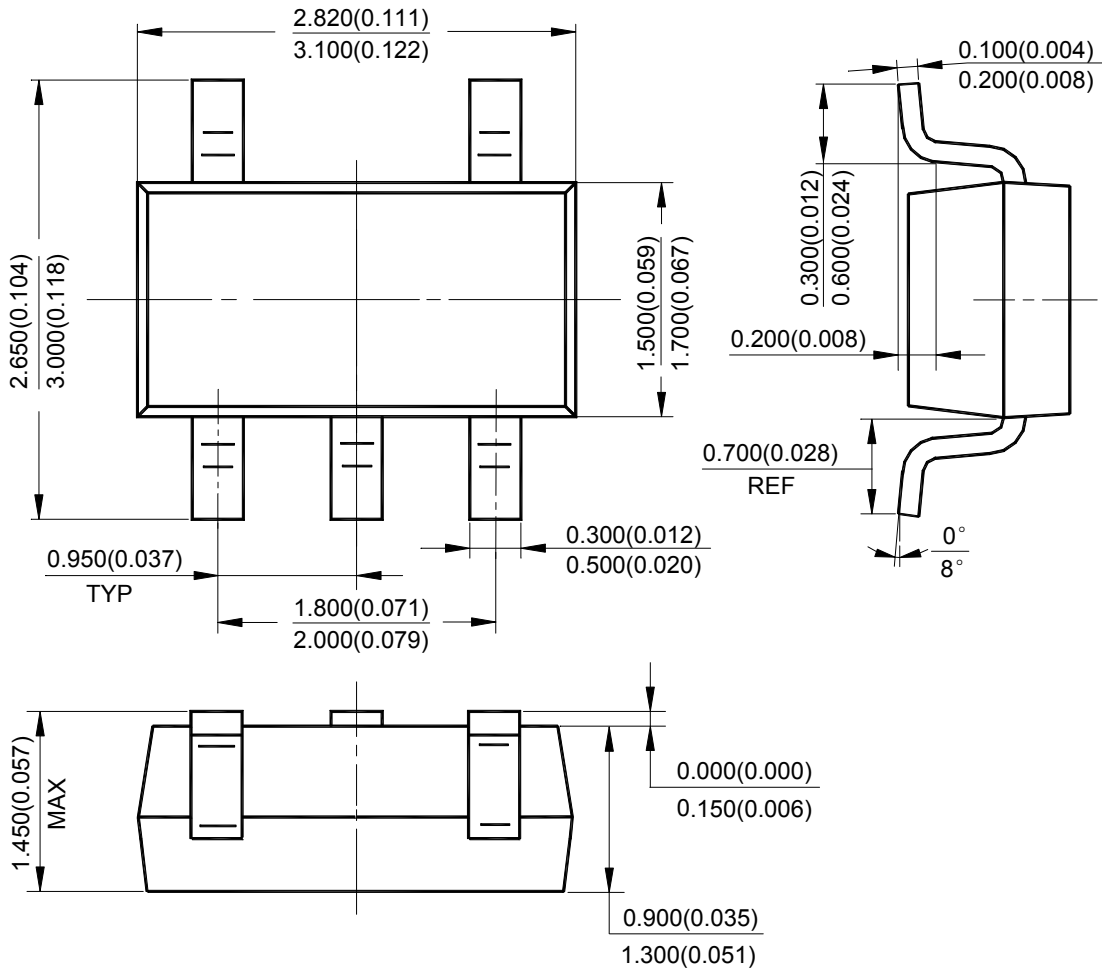

Suggested Pad Layout

SC-70-5

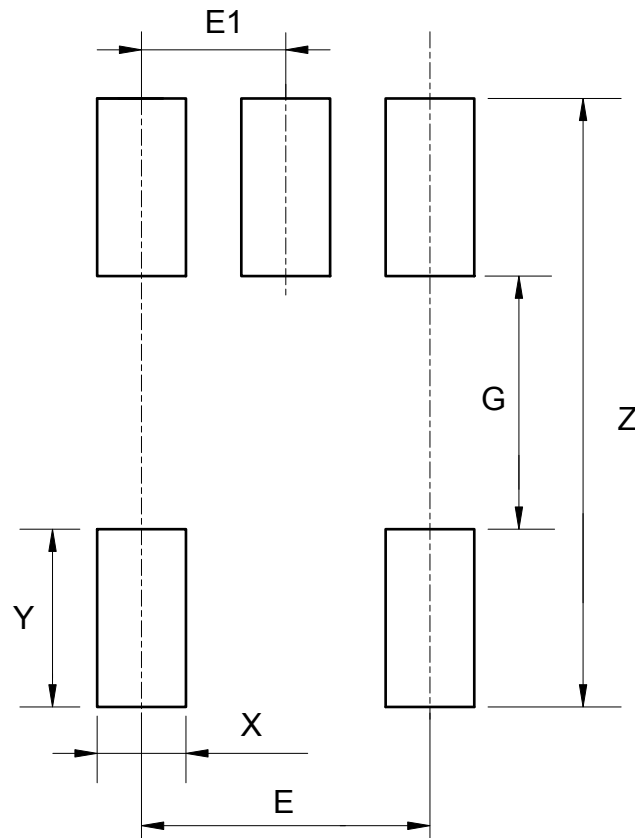

Dimensions	Z (mm)/(inch)	G (mm)/(inch)	X (mm)/(inch)	Y (mm)/(inch)	E (mm)/(inch)	E1 (mm)/(inch)
Value	2.740/0.108	1.140/0.045	0.400/0.016	0.800/0.031	1.300/0.051	0.650/0.026

Suggested Pad Layout (Cont.)

SOT-23-5

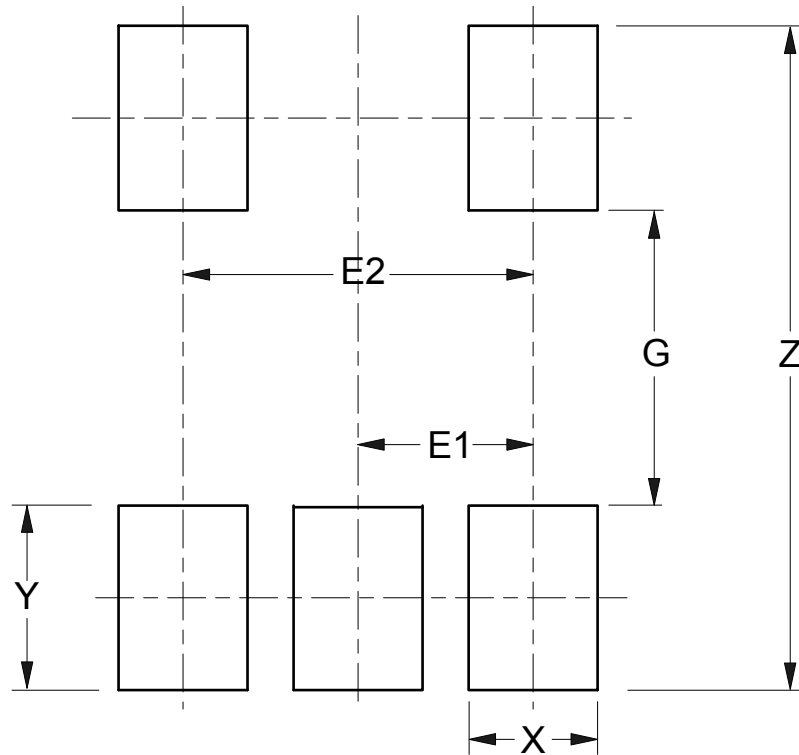

Dimensions	Z (mm)/(inch)	G (mm)/(inch)	X (mm)/(inch)	Y (mm)/(inch)	E1 (mm)/(inch)	E2 (mm)/(inch)
Value	3.600/0.142	1.600/0.063	0.700/0.028	1.000/0.039	0.950/0.037	1.900/0.075

IMPORTANT NOTICE

DIODES INCORPORATED MAKES NO WARRANTY OF ANY KIND, EXPRESS OR IMPLIED, WITH REGARDS TO THIS DOCUMENT, INCLUDING, BUT NOT LIMITED TO, THE IMPLIED WARRANTIES OF MERCHANTABILITY AND FITNESS FOR A PARTICULAR PURPOSE (AND THEIR EQUIVALENTS UNDER THE LAWS OF ANY JURISDICTION).

Diodes Incorporated and its subsidiaries reserve the right to make modifications, enhancements, improvements, corrections or other changes without further notice to this document and any product described herein. Diodes Incorporated does not assume any liability arising out of the application or use of this document or any product described herein; neither does Diodes Incorporated convey any license under its patent or trademark rights, nor the rights of others. Any Customer or user of this document or products described herein in such applications shall assume all risks of such use and will agree to hold Diodes Incorporated and all the companies whose products are represented on Diodes Incorporated website, harmless against all damages.

Diodes Incorporated does not warrant or accept any liability whatsoever in respect of any products purchased through unauthorized sales channel. Should Customers purchase or use Diodes Incorporated products for any unintended or unauthorized application, Customers shall indemnify and hold Diodes Incorporated and its representatives harmless against all claims, damages, expenses, and attorney fees arising out of, directly or indirectly, any claim of personal injury or death associated with such unintended or unauthorized application.

Products described herein may be covered by one or more United States, international or foreign patents pending. Product names and markings noted herein may also be covered by one or more United States, international or foreign trademarks.

This document is written in English but may be translated into multiple languages for reference. Only the English version of this document is the final and determinative format released by Diodes Incorporated.

LIFE SUPPORT

Diodes Incorporated products are specifically not authorized for use as critical components in life support devices or systems without the express written approval of the Chief Executive Officer of Diodes Incorporated. As used herein:

A. Life support devices or systems are devices or systems which:

1. are intended to implant into the body, or
2. support or sustain life and whose failure to perform when properly used in accordance with instructions for use provided in the labeling can be reasonably expected to result in significant injury to the user.

B. A critical component is any component in a life support device or system whose failure to perform can be reasonably expected to cause the failure of the life support device or to affect its safety or effectiveness.

Customers represent that they have all necessary expertise in the safety and regulatory ramifications of their life support devices or systems, and acknowledge and agree that they are solely responsible for all legal, regulatory and safety-related requirements concerning their products and any use of Diodes Incorporated products in such safety-critical, life support devices or systems, notwithstanding any devices- or systems-related information or support that may be provided by Diodes Incorporated. Further, Customers must fully indemnify Diodes Incorporated and its representatives against any damages arising out of the use of Diodes Incorporated products in such safety-critical, life support devices or systems.

Copyright © 2013, Diodes Incorporated

www.diodes.com

Looking for pricing, stock, or lifecycle information?

Click below to explore more details on WIN SOURCE:

- ⊖ [View AZV321KTR-E1 on WIN SOURCE](#)
- ⊖ [Diodes Incorporated Information](#)

Optimize Your Supply Chain with WIN SOURCE Solutions

- ✓ Global Sourcing Solution
- ✓ Obsolete Management
- ✓ Cost Control Management
- ✓ Shortage Management
- ✓ Alternative Solution
- ✓ Excess Inventory Management