



**THE DATASHEET OF  
HMC908LC5TR**





## GaAs MMIC I/Q DOWNCONVERTER 9 - 12 GHz

### Typical Applications

The HMC908LC5 is ideal for:

- Point-to-Point and Point-to-Multi-Point Radio
- Military Radar, EW & ELINT
- Satellite Communications
- Maritime & Mobile Radio

### Features

- Conversion Gain: 11 dB
- Image Rejection: 25 dB
- LO to RF Isolation: -50 dB
- Noise Figure: 2.2 dB
- Input IP3: +2 dBm
- 32 Lead 5x5mm Ceramic SMT Package: 25mm<sup>2</sup>

### Functional Diagram

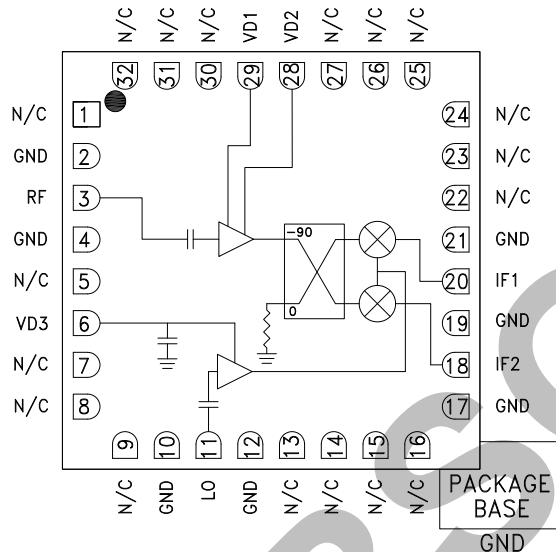

### General Description

The HMC908LC5 is a compact GaAs MCM I/Q downconverter in a leadless RoHS compliant SMT ceramic package. This device provides a small signal conversion gain of 11 dB with a noise figure of 2.2 dB and 25 dB of image rejection. The HMC908LC5 utilizes an LNA followed by an image reject mixer which is driven by an LO buffer amplifier. The image reject mixer eliminates the need for a filter following the LNA, and removes thermal noise at the image frequency. I and Q mixer outputs are provided and an external 90° hybrid is needed to select the required sideband. The HMC908LC5 is a much smaller alternative to hybrid style image reject mixer downconverter assemblies, and it eliminates the need for wire bonding by allowing the use of surface mount manufacturing techniques.

### Electrical Specifications, $T_A = +25\text{ }^\circ\text{C}$ , $IF = 100\text{ MHz}$ , $LO = 0\text{ dBm}$ , $VD1 = VD2 = 3V$ , $VD3 = 5V^*$

| Parameter                  | Min.       | Typ. | Max. | Units |
|----------------------------|------------|------|------|-------|
| Frequency Range, RF        | 9 - 12     |      |      | GHz   |
| Frequency Range, LO        | 5.5 - 15.5 |      |      | GHz   |
| Frequency Range, IF        | DC - 3.5   |      |      | GHz   |
| Conversion Gain (As IRM)   | 8          | 11   |      | dB    |
| Noise Figure               |            | 2.2  |      | dB    |
| Image Rejection            | 15         | 25   |      | dB    |
| 1 dB Compression (Input)   |            | -5   |      | dBm   |
| LO to RF Isolation         | 40         | 50   |      | dB    |
| LO to IF Isolation         | 5          | 10   |      | dB    |
| IP3 (Input)                | -3         | 2    |      | dBm   |
| Amplitude Balance          |            | ±1   |      | dB    |
| Phase Balance              |            | ±6   |      | Deg   |
| Supply Current (ID1 + ID2) |            | 60   | 88   | mA    |
| Supply Current (ID3)       |            | 100  | 120  | mA    |

\*Data taken as IRM with external IF Hybrid



**GaAs MMIC I/Q DOWNCONVERTER  
9 - 12 GHz**

*Data Taken As IRM With External IF Hybrid*

**Conversion Gain vs. Temperature**

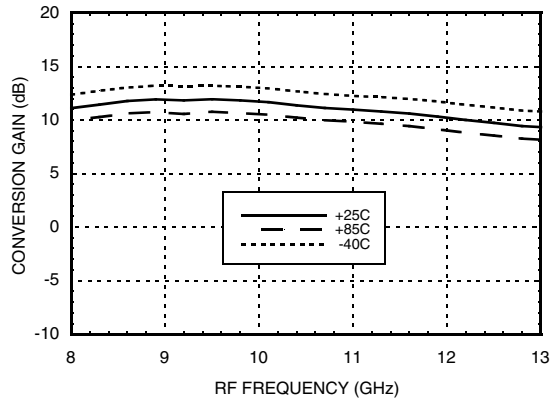

**Image Rejection vs. Temperature**

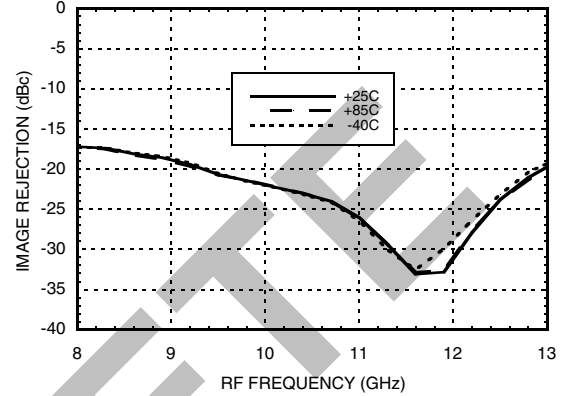

**Conversion Gain vs. LO Drive**

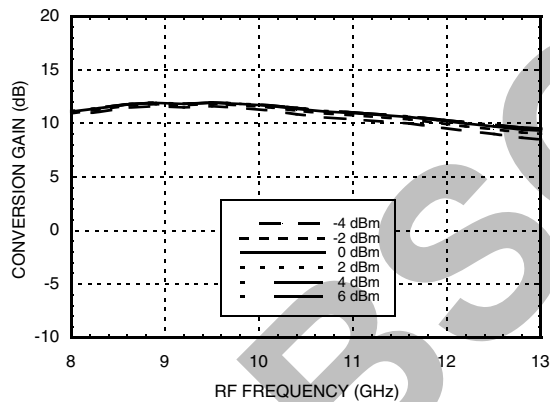

**Return Loss**

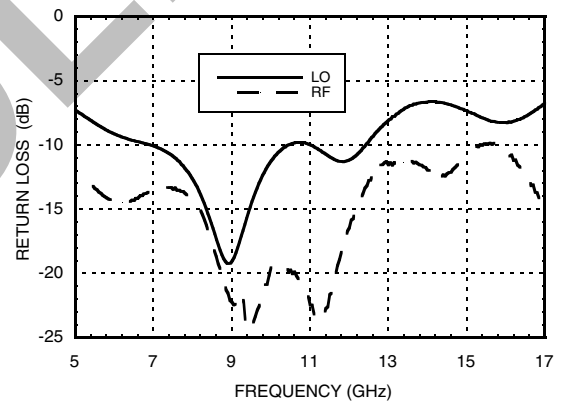

**Input P1dB vs. Temperature**

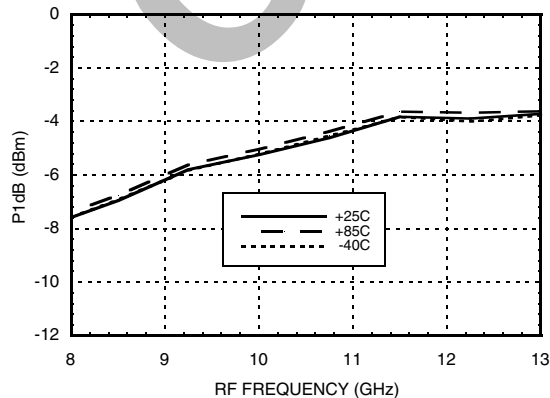

**Input IP3 vs. LO Drive**

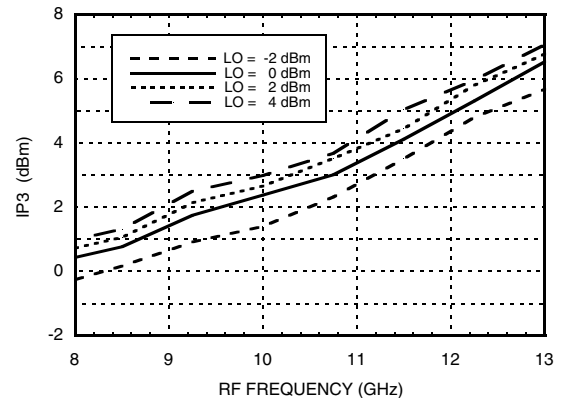

Information furnished by Analog Devices is believed to be accurate and reliable. However, no responsibility is assumed by Analog Devices for its use, nor for any infringements of patents or other rights of third parties that may result from its use. Specifications subject to change without notice. No license is granted by implication or otherwise under any patent or patent rights of Analog Devices. Trademarks and registered trademarks are the property of their respective owners.

For price, delivery, and to place orders: Analog Devices, Inc., One Technology Way, P.O. Box 9106, Norwood, MA 02062-9106 Phone: 781-329-4700 • Order online at [www.analog.com](http://www.analog.com) Application Support: Phone: 1-800-ANALOG-D



**GaAs MMIC I/Q DOWNCONVERTER**  
**9 - 12 GHz**

**Quadrature Channel Data Taken Without IF Hybrid**

**Isolations**

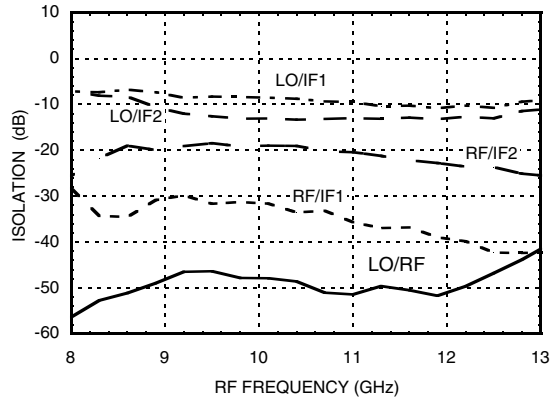

**IF Bandwidth\***

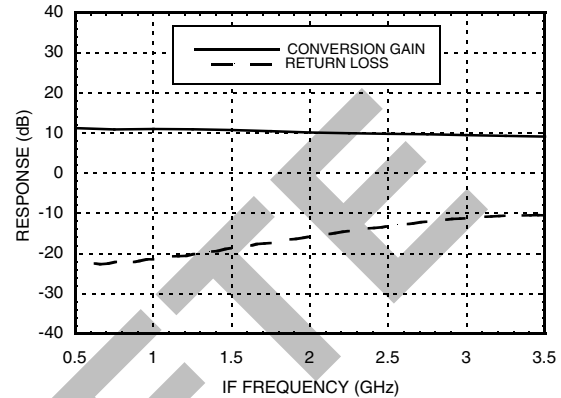

**Amplitude Balance vs. LO Drive**

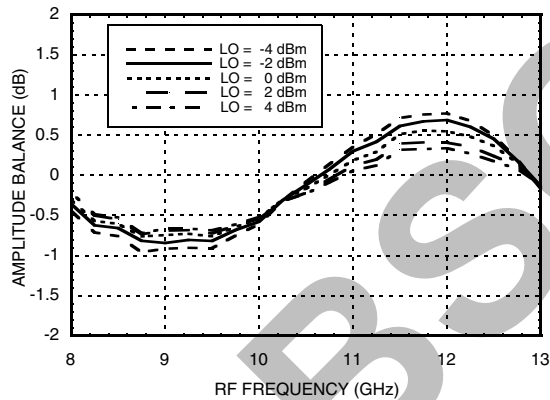

**Phase Balance vs. LO Drive**

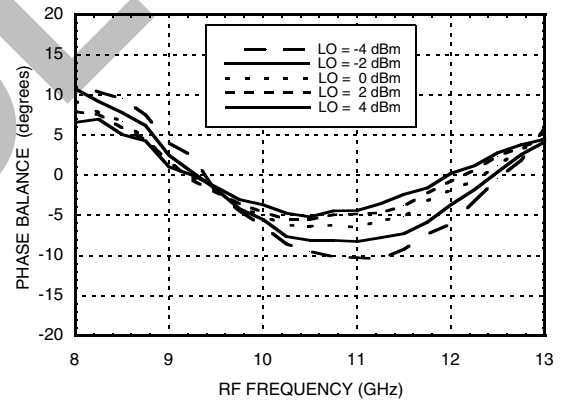

**Noise Figure vs. LO Drive, LO Frequency = 10 GHz**

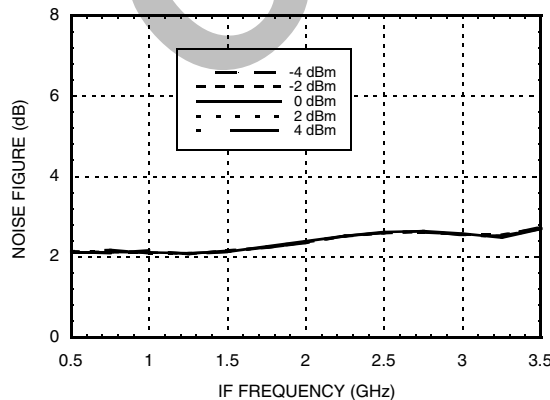

**Noise Figure vs. LO Drive, IF Frequency = 100 MHz**

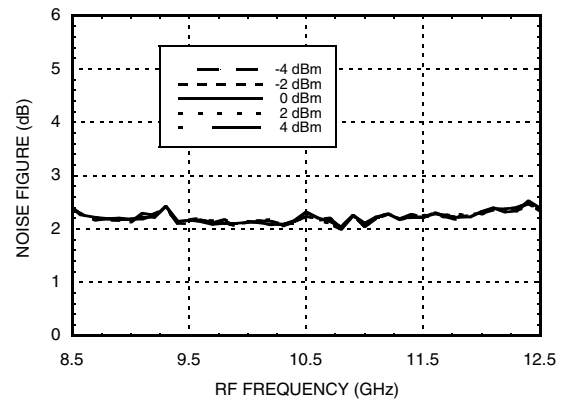

\* Conversion gain data taken with external IF hybrid, LO frequency fixed at 10 GHz and RF varied

Information furnished by Analog Devices is believed to be accurate and reliable. However, no responsibility is assumed by Analog Devices for its use, nor for any infringements of patents or other rights of third parties that may result from its use. Specifications subject to change without notice. No license is granted by implication or otherwise under any patent or patent rights of Analog Devices. Trademarks and registered trademarks are the property of their respective owners.

For price, delivery, and to place orders: Analog Devices, Inc., One Technology Way, P.O. Box 9106, Norwood, MA 02062-9106 Phone: 781-329-4700 • Order online at [www.analog.com](http://www.analog.com) Application Support: Phone: 1-800-ANALOG-D



## GaAs MMIC I/Q DOWNCONVERTER 9 - 12 GHz

### MxN Spurious Outputs

| mRF | nLO |    |    |    |    |
|-----|-----|----|----|----|----|
|     | 0   | 1  | 2  | 3  | 4  |
| 0   | xx  | 27 | 36 | 37 | 92 |
| 1   | 16  | 0  | 34 | 68 | 61 |
| 2   | 92  | 66 | 57 | 70 | 92 |
| 3   | 92  | 92 | 81 | 57 | 92 |
| 4   | 92  | 92 | 92 | 92 | 92 |

RF = 10.6 GHz @ -20 dBm  
 LO = 10.5 GHz @ 0 dBm  
 Data taken without IF hybrid  
 All values in dBc below IF power level.

### Absolute Maximum Ratings

|  |                |
|--|----------------|
| RF   | +5 dBm         |
| LO Drive   | +20 dBm        |
| VD1, VD2   | 4.0V           |
| VD3  | 5.5V           |
| Channel Temperature  | 150°C          |
| Continuous Pdiss (T=85°C)<br>(derate 9.56 mW/°C above 85°C)          | 0.65 W         |
| Thermal Resistance (R <sub>TH</sub> )<br>(channel to package bottom) | 71 °C/W        |
| Storage Temperature  | -65 to +150 °C |
| Operating Temperature  | -55 to +85 °C  |
| ESD Sensitivity (HBM)  | Class 0, 150V  |



**ELECTROSTATIC SENSITIVE DEVICE  
OBSERVE HANDLING PRECAUTIONS**

### Outline Drawing

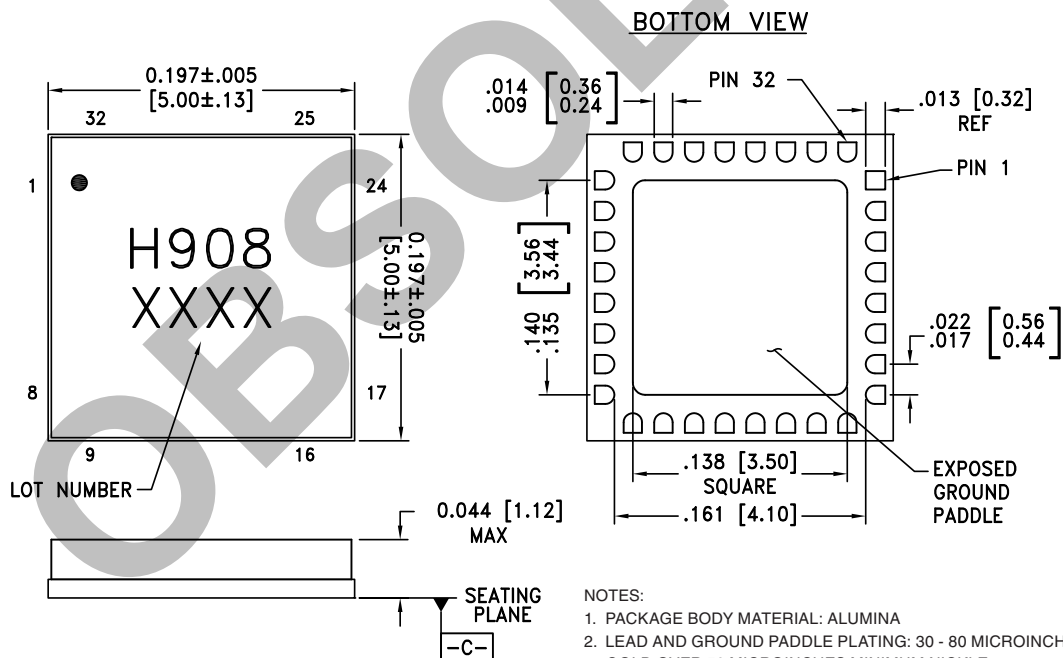

#### NOTES:

1. PACKAGE BODY MATERIAL: ALUMINA
2. LEAD AND GROUND PADDLE PLATING: 30 - 80 MICROINCHES GOLD OVER 50 MICROINCHES MINIMUM NICKLE
3. DIMENSIONS ARE IN INCHES [MILLIMETERS]
4. LEAD SPACING TOLERANCE IS NON-CUMULATIVE
5. PACKAGE WARP SHALL NOT EXCEED 0.05mm DATUM
6. ALL GROUND LEADS AND GROUND PADDLE MUST BE SOLDERED TO PCB RF GROUND

### Package Information

| Part Number | Package Body Material | Lead Finish | MSL Rating          | Package Marking <sup>[1]</sup> |
|-------------|-----------------------|-------------|---------------------|--------------------------------|
| HMC908LC5   | Alumina               | Gold        | MSL3 <sup>[2]</sup> | H908<br>XXXX                   |

[1] 4-Digit lot number XXXX

[2] Max peak reflow temperature of 260 °C



**GaAs MMIC I/Q DOWNCONVERTER  
9 - 12 GHz**

**Pin Descriptions**

| Pin Number                                   | Function | Description   | Interface Schematic |
|--|----------|---|---------------------|
| 1, 5, 7 - 9,<br>13 - 16, 22 - 27,<br>30 - 32 | N/C      | The pins are not connected internally; however, all data shown herein was measured with these pins connected to RF/DC ground externally.  |                     |
| 2, 4, 10, 12,<br>17, 19, 21                  | GND      | These pins and ground paddle must be connected to RF/DC ground.   |                     |
| 3  | RF       | This pin is AC coupled and matched to 50 Ohms.  |                     |
| 6  | VD3      | Power supply for LO amplifier.  |                     |
| 28, 29                                       | VD1, VD2 | Power supply for RF LNA.  |                     |
| 18   | IF2      | This pin is DC coupled. For applications not requiring operation to DC, this port should be DC blocked externally using a series capacitor whose value has been chosen to pass the necessary frequency range. For operation to DC, this pin must not sink / source more than 3 mA of current or part non-function and possible failure will result. |                     |
| 20   | IF1      |   |                     |
| 11   | LO       | This pin is AC coupled and matched to 50 Ohms.  |                     |

**Typical Application**

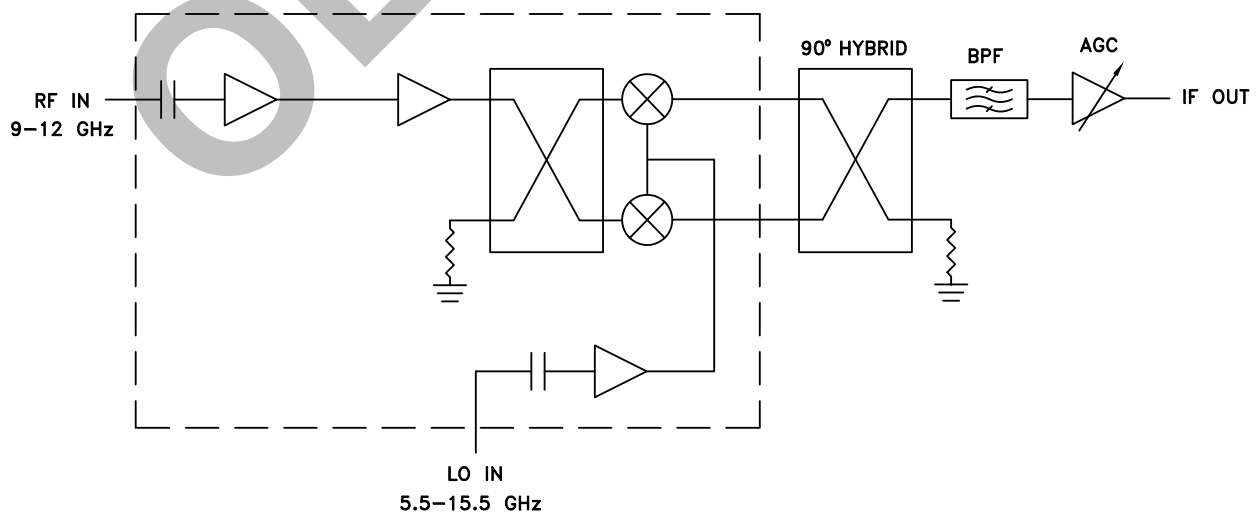

Note: LSB and USB is determined by GND on Hybrid

Information furnished by Analog Devices is believed to be accurate and reliable. However, no responsibility is assumed by Analog Devices for its use, nor for any infringements of patents or other rights of third parties that may result from its use. Specifications subject to change without notice. No license is granted by implication or otherwise under any patent or patent rights of Analog Devices. Trademarks and registered trademarks are the property of their respective owners.

For price, delivery, and to place orders: Analog Devices, Inc., One Technology Way, P.O. Box 9106, Norwood, MA 02062-9106 Phone: 781-329-4700 • Order online at [www.analog.com](http://www.analog.com) Application Support: Phone: 1-800-ANALOG-D



**Evaluation PCB**

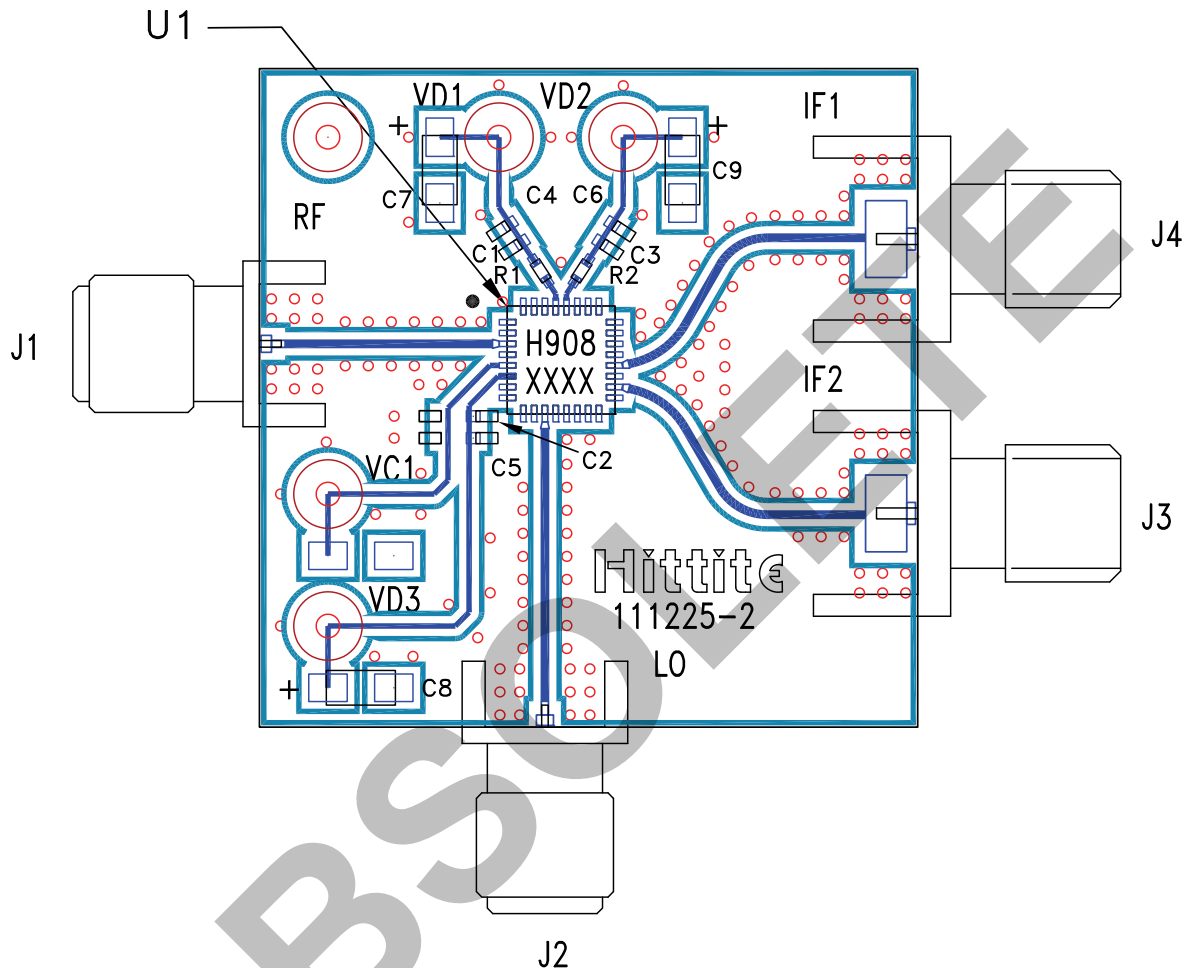

**List of Materials for Evaluation PCB 111227 [1]**

| Item       | Description                       |
|------------|-----------------------------------|
| J1, J2     | PCB Mount SMA RF Connector, SRI   |
| J3, J4     | PCB Mount SMA Connector, Johnson  |
| J5 - J7    | DC Pin                            |
| C1, C2, C3 | 100 pF Capacitor 0402, Pkg.       |
| C4, C5, C6 | 1000 pF Capacitor 0402, Pkg.      |
| C7, C8, C9 | 2.2 μF Capacitor, Tantalum Case A |
| R1, R2     | 0 Ohm Resistor, 0402 Pkg.         |
| U1         | HMC908LC5                         |
| VC1        | N/C                               |
| PCB [2]    | 111225 Evaluation Board           |

[1] Reference this number when ordering complete evaluation PCB

[2] Circuit Board Material: Rogers 4350

The circuit board used in the application should use RF circuit design techniques. Signal lines should have 50 Ohm impedance while the package ground leads and exposed paddle should be connected directly to the ground plane similar to that shown. A sufficient number of via holes should be used to connect the top and bottom ground planes. The evaluation circuit board shown is available from Hittite upon request.

## Looking for pricing, stock, or lifecycle information?

Click below to explore more details on WIN SOURCE:

 [View HMC908LC5TR on WIN SOURCE](#)

 [Analog Devices Inc. Information](#)

## Optimize Your Supply Chain with WIN SOURCE Solutions

-  Global Sourcing Solution
-  Obsolete Management
-  Cost Control Management
-  Shortage Management
-  Alternative Solution
-  Excess Inventory Management