



**THE DATASHEET OF
SS65100-030F**



Stewart Connector

Product Specification

PR022-01

Revision C0 3/2/2016

Modular Products

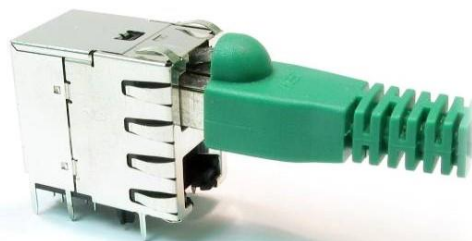
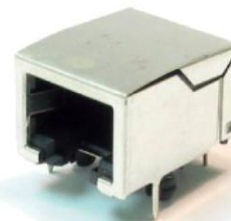
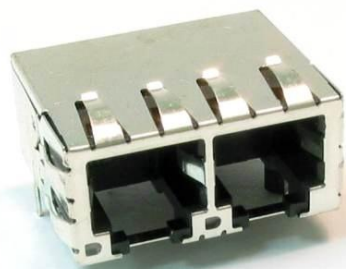

Stewart Connector

1.0 Objective

This document establishes the performance requirements and outlines qualification tests for shielded and unshielded modular connectors produced by Stewart Connector. These products are intended to be soldered onto a printed circuit board or terminated onto a cable and mated to a compatible Stewart Connector modular product.

2.0 Scope

This specification is applicable to shielded and unshielded modular products.

3.0 General

This document is comprised of the following sections (specifications subject to change without notice):

<u>Paragraph</u>	<u>Title</u>
1.0	Objective
2.0	Scope
3.0	General
Table 1	Qualification Test Matrix
4.0	Applicable Documents
Table 2	IEC Modular Plug and Jack Standards
5.0	General Requirements
6.0	Soldering Process Requirements
Table 3	Wave Solder
Figure 1	IR Reflow Profile
7.0	Quality Assurance Provisions
Table 4	Inspection Conditions
8.0	Requalification of Products
9.0	Electrical Requirements
Table 5	LLCR
Figure 2	Bulk Contact Interface LLCR Measurement
Figure 3	Bulk Shield Interface LLCR Measurement
Figure 4	LLCR Measurement Configuration
Table 6	Insulation Resistance
Table 7	DWV (Adjacent Contacts)
Table 8	DWV (Contacts to Shield)
10.0	Mechanical Requirements
Table 9	Mechanical Durability
Table 10	Gauging – Go Gauges
Table 11	Mating / Unmating Force
Figure 5	Discontinuity Configuration
Table 12	Mechanical Shock
Table 13	Sinusoidal Vibration
Table 14	Random Vibration
Table 15	Rotational Test
11.0	Environmental Conditions
Table 16	Temperature Life
Table 17	Thermal Shock
Table 18	Temperature / Humidity

Table 1
Qualification Testing Matrix

Stewart Connector

Qualification Testing Matrix		Test Groups								
		1	2	3	4	5	6	7	8 (4)	9
Test	Para.	Testing Sequence (3)								
Examination of Product	5.5	1,5	1,5	1,7	1,7	1,5	1,6	1,8	1,5	1,3
Low Level Contact Resistance	9.1	2,4	2,4		2,6	2,4	2,4	2,4	2,4	
Temperature Rise vs. Current	9.2	3								
Durability	10.1		3							
Gaging	10.2			2						
PCB Insertion Force	10.3			3						
Mating / Unmating Force	10.4			4						
Discontinuity	10.5			5						
Latch Strength	10.6			6						
Mechanical Shock	10.7				5					
Vibration (Sinusoidal)	10.8				3					
Vibration (Random)	10.9				4					
Temperature Life	11.1					3				
Thermal Shock	11.2						3			
Temperature/Humidity	11.3							3		
Insulation Resistance	9.3						5	5		
D. W. V. (Adj. Contacts) (2)	9.4								6	
D. W. V. (Contacts-Shield) (1,2)	9.5								7	
RJ-11 Insertion (4)	10.10									3
Rotational Test	10.11									2

- Note:
- 1 Only Applies to Shielded Product
 - 2 DWV stands for Dielectric Withstand Voltage
 - 3 Numbers indicate sequence in which tests are performed.
 - 4 Test Group 8 Applies to RJ-45 style jacks only

Stewart Connector

4.0 Applicable Documents

4.1 Stewart Connector Specifications:

- 4.1.1 Product Drawings
- 4.1.2 Customer Drawings
- 4.1.3 Test Specifications

4.2 Other Standards and Specifications (Applicable in Part):

- 4.2.1 UL94V-0 Flammability
- 4.2.2 EIA-364
- 4.2.3 EIA/TIA-568
- 4.2.4 EIA/TIA-570
- 4.2.5 IEC 60603-7
- 4.2.6 TIA 1096
- 4.2.7 IEEE 802.3

Table 2
IEC Modular Plug and Jack Standards

Category	Type	Standard
Base Specification	UTP	IEC 60603-7
	ScTP	IEC 60603-7-1
Category 5e	UTP	IEC 60603-7-2
Category 5e	ScTP	IEC 60603-7-3
Category 6	UTP	IEC 60603-7-4
Category 6	ScTP	IEC 60603-7-5

UTP – Unshielded Twisted Pair

ScTP – Screened Twisted Pair

Additional specifications and standards may be referenced as applicable. The latest revisions of the above specifications available at the date of issue of this specification are used unless otherwise indicated.

Stewart Connector

5.0 General Requirements

5.1 Qualification:

Connectors furnished under this specification shall be capable of meeting the qualification test requirements specified herein.

5.2 Material:

5.2.1 Plastic Housings: UL94V-0

5.2.2 Contacts: Copper Alloy

5.2.3 Shield: Copper Alloy

5.3 Finish:

5.3.1 Contacts: Gold Selectively Plated

5.3.2 Contacts: Nickel Plated All Over

5.3.3 Reference Customer Drawing for Contact Solder Tails

5.3.4 Shield: Tin or Nickel Plated All Over

5.4 Design and Construction:

Connectors shall be of the design, construction and physical dimensions as specified on the applicable product drawing and TIA 1096. In case of conflict between this specification and product drawings, the drawings shall take precedence. 50 μinch (1.27 μm) gold plated connectors compliant with TIA 1096 specifications.

5.5 Examination of Product:

Connectors shall meet all specified dimensions of product drawings and internal workmanship standards. There shall be no evidence of cracking, chipping, contamination or loose parts when inspected, without magnification, to the unaided eye.

5.6 Operating and Storage Temperature Range: -40 °C to 85 °C

5.7 Ratings:

5.7.1 Current: 1.5 amperes maximum at 25°C

5.7.2 Voltage: 150 VAC maximum

5.8 Minimum Number of Mating/Unmating Operations:

5.8.1 Performance Level 1: 750 Cycles

5.8.2 Performance Level 2: 2500 Cycles

5.9 Minimum Number of Cable Re-Terminations:

5.9.1 Refer to application drawings

Stewart Connector

6.0 Soldering Process Requirements

6.1 Wave Solder:

Modular connectors are capable of withstanding wave solder temperatures without any functional deterioration. See Table 3 below:

Table 3
Wave Solder Process Profile

	Maximum Temperature	Maximum Temperature Exposure Time
Low-Temp Products	428°F (220°C)	10 Seconds
High-Temp Products	500°F (260°C)	10 Seconds

6.2 IR Reflow Solder:

High-temperature modular connectors are capable of withstanding non-focused infrared (IR) reflow and equivalents at up to 500°F (260°C) without any functional deterioration. The modular jacks shall be exposed to profiles as specified in Figure 1 below:

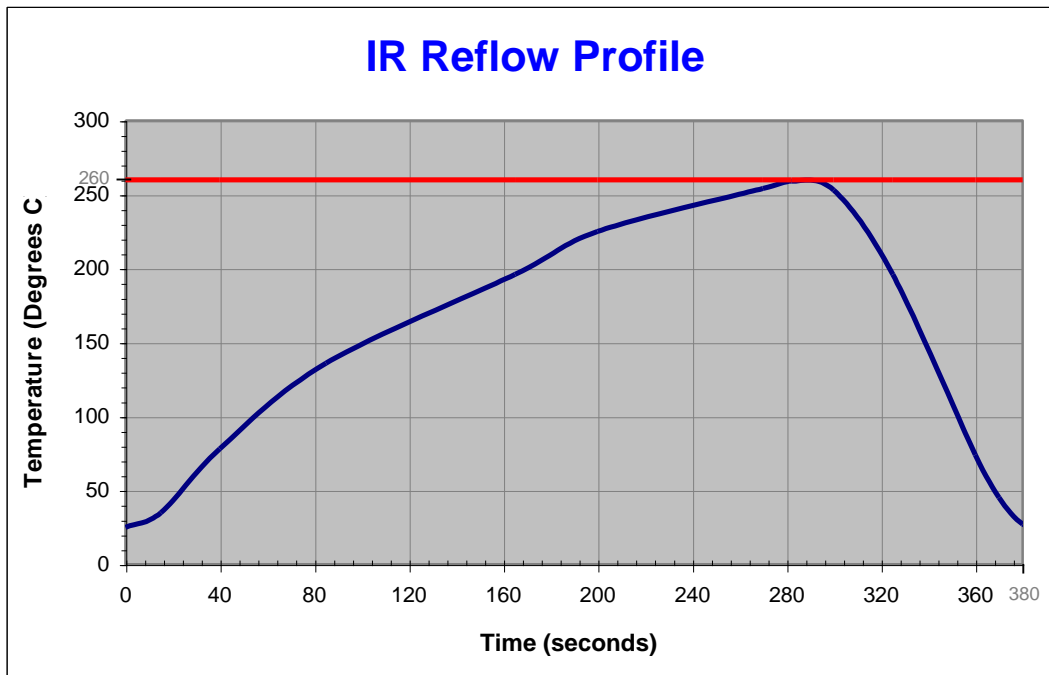

FIGURE 1

* Note: IR Profile may not apply to products with LEDs or light pipes. Please consult factory for specifics.

Stewart Connector

7.0 Quality Assurance Provisions

7.1 Equipment Calibration:

All test equipment and inspection facilities used in the performance of any test shall be maintained and calibrated in accordance with Stewart Connector Operating Procedures and/or other applicable specifications.

7.2 Inspection Conditions:

Unless otherwise specified, all inspections shall be performed under the conditions noted. See Table 2 below:

Table 4
Inspection Conditions

Temperature (± 5 °C)	Relative Humidity (%)	Barometric Pressure
25	30 to 50	Local Ambient

7.3 Sample Quantity and Description:

The test samples required for groups 1 through 9 in Table 1 shall be chosen to comprise a group that consists of 80 contacts, on 10 ports, on two connectors minimum. For samples with multiple contact designs, there shall be 20 examples minimum of each individual contact design.

Test group 8 is only applicable to 8 and 10 position RJ-45 style jacks.

The test samples required for group 10 in Table 1 shall be chosen to comprise a group that consists of 16 total contacts on 2 connectors minimum.

7.4 Acceptance:

7.4.1 All samples tested in accordance with this product specification shall meet the stated requirements.

7.4.2 Failures attributed to equipment, test set-up, sample preparation problems, contaminants or operator error, should not disqualify the product. Corrective action will be taken and samples re-submitted for qualification.

8.0 Requalification of Products

8.1 Requalification Testing

If changes are made to the product, design or manufacturing process after initial product qualification that are judged by the management of Stewart Connector to materially affect the product form, fit or function, then new product samples shall be subject to full or partial requalification testing.

Stewart Connector

9.0 Electrical Requirements

9.1 Low Level Contact Resistance (Board Mounted Product):

LLCR should be measured (mated with a Stewart Connector plug) in accordance with EIA-364-23 with a test current of 100 mA and a maximum open circuit voltage of 20 mVDC (dry circuit test). See Table 5 below:

Table 5
Low Level Contact Resistance

Contacts		Shield Interface **	
Initial (mΩ)	Final (mΩ)	Initial (mΩ)	Final (mΩ)
100 *	Δ20	20	40

All values listed are maximum values.

* 100 mΩ Initial LLCR Includes Bulk

** Shield Interface LLCR Not Applicable to Unshielded Connectors

Low Level Contact Resistance (LLCR) is measured on a mated Plug and Jack. Measurements are generally performed before and after environmental exposure or mechanical conditioning. Bulk LLCR is measured between a mated Plug conductor and Jack printed wiring board (PWB) pin. Bulk resistance consists of the following four (4) components. Refer to Figure 2 below.

$$\text{Contacts } R_{\text{Bulk}} = R_{\text{ab}} + R_{\text{bc}} + R_{\text{cd}} + R_{\text{de}}$$

- (1) (R_{ab}) Plug Conductor Resistance
- (2) (R_{bc}) Plug Blade/Conductor Contact Resistance
- (3) (R_{cd}) Plug Blade/Jack Wire Contact Resistance
- (4) (R_{de}) Jack Wire Resistance

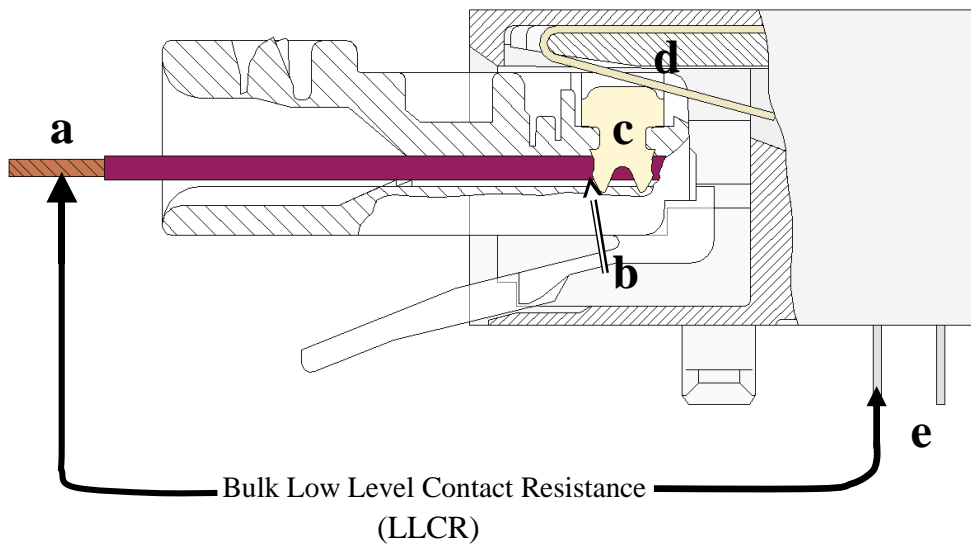

FIGURE 2

Stewart Connector

9.1 Low Level Contact Resistance: (Cont.)

$$\text{Shield Interface } R_{\text{Bulk}} = R_{\text{ab}} + R_{\text{bc}} + R_{\text{cd}} + R_{\text{de}}$$

- (1) (R_{ab}) Jack Shield Resistance
- (2) (R_{bc}) Jack Shield/Plug Shield Contact Resistance
- (3) (R_{cd}) Plug Shield/Cable Shield Contact Resistance
- (4) (R_{de}) Cable Shield Resistance

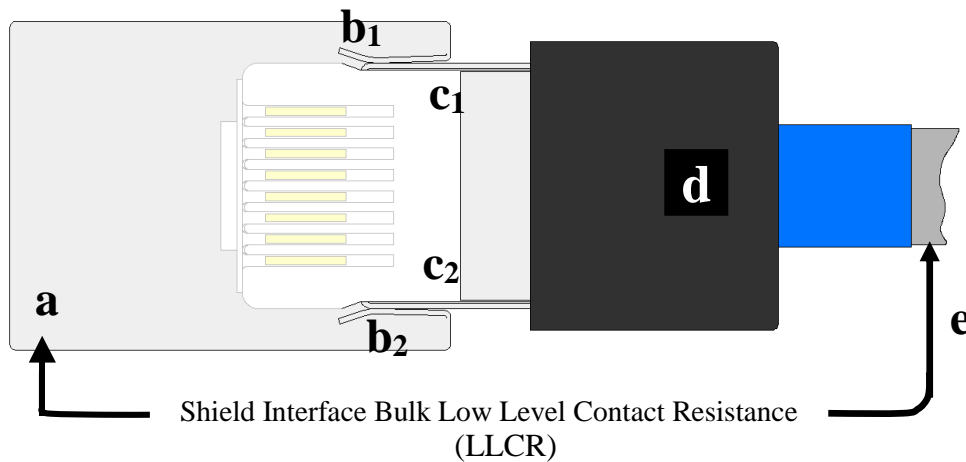

FIGURE 3

Typical Bulk contact resistance of a mated plug and jack can range between 20 to 50 m Ω . Stewart Connector product specification requirement is a bulk contact resistance change after conditioning. In most cases, the maximum allowable change in bulk contact resistance after environmental conditioning is 20 m Ω .

LLCR measurements are conducted utilizing a four (4) wire dry circuit test method. Implementation consists of a 100 mA DC current source with a maximum open circuit voltage of 20 mV. Measurements are performed using low current and voltage levels to preserve oxides and films that may form during environmental conditioning.

In practice, Jacks are mounted on PWB boards, which are design to interface with automated switching and measuring equipment. Stewart Connector LLCR measuring system consists of a Micro-Ohmmeter and a Hewlett Packard Data Acquisition Switch Unit. Automation software is utilized to fully control the measurement sequence. Refer to measurement configuration in Figure 4 below.

Stewart Connector

9.1 Low Level Contact Resistance: (Cont.)

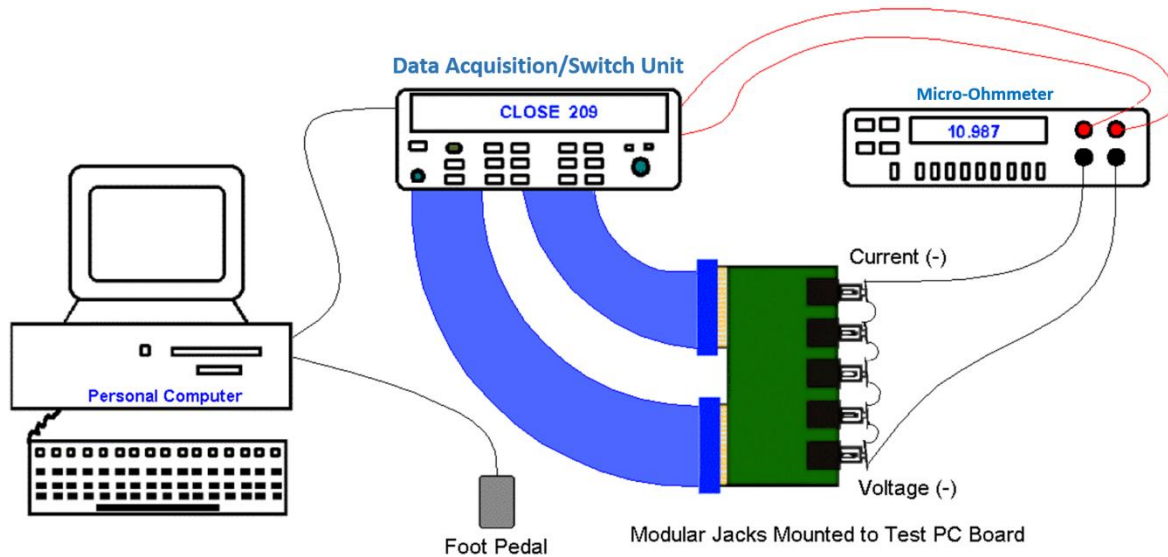

FIGURE 4

9.2 Temperature Rise versus Current:

The temperature rise above ambient (25°C) shall not exceed 30 °C at any point on the connector when all contacts are powered in series with 1.5 Amps DC in accordance with EIA-364-70.

9.3 Insulation Resistance:

The insulation resistance of the unmated connectors shall be measured in accordance with EIA-364-21. See Table 6 below:

**Table 6
Insulation Resistance**

Test Voltage (VDC)	Test Duration (Minutes)	Requirement (MΩ)	Points of Measurement
500	1	500	Between adjacent contacts
500	1	500	Between contacts and shield**

** Not Applicable to Unshielded Connectors

Stewart Connector

- 9.4 Dielectric Withstanding Voltage (DWV) Adjacent Contacts:
There shall be no arc over, insulation breakdown or excessive leakage (>1 mA) when tested in accordance with EIA-364-20 on mated connectors. See Table 7 below:

Table 7
DWV – Adjacent Contacts

Test Voltage	Test Duration (Minutes)	Points of Measurement
1000 VAC _{RMS} or 1414 VDC	1	Between adjacent contacts

- 9.5 ** Dielectric Withstanding Voltage (DWV) Contact to Shield:
There shall be no arc over, insulation breakdown or excessive leakage (>1 mA) when tested in accordance with EIA-364-20 on mated connectors. See Table 8 below:

Table 8
DWV – Contact to Shield

Connector	Test Voltage	Test Duration (Minutes)	Points of Measurement
All Connectors	1500 VAC _{RMS} or 2121 VDC	1	Between contacts and shield

** Not Applicable to Unshielded Connectors

10.0 Mechanical Requirements

10.1 Durability:

The durability of a connector is a conditioning sequence that is to be evaluated with reference to a change in LLCR as specified in EIA-364-15. See Table 9 below:

Table 9
Mechanical Durability

Performance Level	Rate of Travel (cycles/hour)	Cycles (number of times)
PL 1	600	750 Total
PL 2	600	2500 Total

Mated to compatible Stewart Connector
Attributable to the separable contact interface.

10.2 Gauging:

Samples must pass all gauges and forces in accordance with IEC 60603-7. Samples shall not be capable of mating with the IEC specified No-Go gauges more than 0.070” (1.78 mm) when a force of 2 lbs (8.9 N) is applied. Samples must be capable of mating with the IEC specified Go gauges within the force limits in Table 10.

Table 10
Gauging – Go Gauges

	Max Insertion Force	Max Removal Force
Jacks	2 Lbs (8.9 N)	2 Lbs (8.9 N)
Plugs	4.5 Lbs (20 N)	4.5 Lbs (20 N)

Stewart Connector

10.3 PCB Insertion Force:

A connector, not including shield solder tails or signal contacts, shall require no more than 15 lbs (67 N) of insertion force when inserted into a minimum sized PCB hole specified on the customer print when using pushing force rate of 0.5 inches (12.7 mm) per minute.

10.4 Mating / Unmating Force.

Mating and Unmating forces are to be measured after one cycle pre-conditioning as specified in IEC 60603-7. See Table 11 below:

Table 11
Mating / Unmating Force

Item	Speed	Mating Force	Unmating Force
Unshielded Modular Connector	0.4 inch/sec, 10.16 mm/sec	4.5 lbs, 20 N	4.5 lbs, 20 N
Shielded Modular Connector	0.4 inch/sec, 10.16 mm/sec	6.7 lbs, 30 N	6.7 lbs, 30 N

All values listed are maximum values.
Modular plug tested with the latch depressed.

10.5 Discontinuity:

The mated pair shall have no discontinuities greater than 10 μ s when pulled against the plastic walls in the lower (opposite latch tab) position with 4.5 lbs (20 N) minimum applied in the axial direction. Gauge dimensions and test details are in accordance with IEC 60603-7, Annex A. See Figure 5 below:

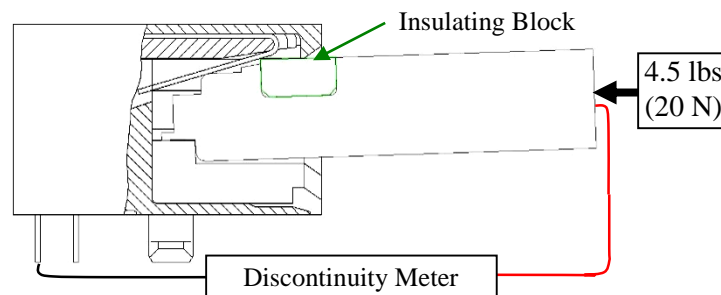

FIGURE 5

10.6 Latch Strength.

Latch Strength will be measured in accordance with EIA-364-98. Samples shall be mounted in a panel cutout as specified on the Customer Print as applicable. The connected pair shall withstand an axial load of 20 pounds minimum at a rate of 0.5 inches per minute.

Stewart Connector

10.7 Mechanical Shock:

Mechanical Shock shall be measured in accordance with EIA-364-27, condition A, with assembled connectors mounted rigidly to table and no discontinuities of >1 microsecond. See Table 12 below:

Table 12
Mechanical Shock

Wave Type	Velocity Change (ft/s)	Number of shocks per direction	Duration Each Face (milliseconds)	Applied Energy (g)	Mutually Perpendicular Axis
Half Sine	11.3	6	11	50	3

10.8 Vibration (Sinusoidal):

Sinusoidal Vibration shall be measured in accordance with EIA-364-28 Test Condition I, with assembled connectors mounted rigidly to vibrating table and no discontinuities of >1 microsecond. See Table 13 below:

Table 13
Sinusoidal Vibration

Wave Type	Amplitude	Frequency (Hz)	Duration Each Face (hours)	Mutually Perpendicular Axis
Sine	.06 in. DA	10 to 55	2	3

10.9 Vibration (Random):

Random Vibration shall be measured in accordance with EIA-364-28 Test Condition V Letter D, with assembled connectors mounted rigidly to vibrating table and no discontinuities of >1 microsecond. See Table 14 below:

Table 14
Random Vibration

Frequency (Hz)	Duration Each Face (minutes)	Overall rms (g)	Mutually Perpendicular Axis
50 to 2000	90	11.95	3

10.10 RJ-11 Insertion:

Eight and Ten position RJ-45 jack samples shall withstand being mated 200 times with a properly terminated six-position RJ-11 plug as specified in EIA/TIA-570.

Stewart Connector

10.11 Rotational Test:

Samples shall exhibit no discontinuities of >1 microsecond when subjected to the following test sequence. See Table 15 below:

Table 15
Rotational Test

Plug	Plug Blade Height	Weight	Angle	Cycle Time	Cycles
RJ45	0.242" / 6.15 mm	10 lbs / 44.5 N	45°	6 sec	3 CW
RJ45	0.242" / 6.15 mm	10 lbs / 44.5 N	45°	6 sec	3 CCW

11.0 Environmental Conditions

Note: Unless otherwise specified, all environmental testing is to be done with the connector in the mated state.

11.1 Temperature Life:

Temperature life shall be measured in accordance with EIA-364-17, per method A. See Table 16 below:

Table 16
Temperature Life

Temperature (°C)	Duration (hours)
85±2	500

11.2 Thermal Shock:

Thermal Shock shall be measured in accordance with EIA/TIA-568. See Table 17 below:

Table 17
Thermal Shock

Temperature (±3 °C)	Number of Cycles	Duration at Each Extreme (Minutes)	Test Condition
-40 to +85	25	30	1

11.3 Temperature / Humidity:

Temperature / Humidity shall be measured in accordance with TIA-568 and EIA-364-31, per method A. See Table 18 below:

Table 18
Temperature / Humidity

Relative Humidity (±3 %)	Low Temperature (±2 °C)	High Temperature (±2 °C)	Cold Sub-cycle (±2 °C)	Cycle Time (hours)	Number Of Cycles
93	25	65	-10	24	21

Looking for pricing, stock, or lifecycle information?

Click below to explore more details on WIN SOURCE:

 [View SS65100-030F on WIN SOURCE](#)

 [Stewart Connector Information](#)

Optimize Your Supply Chain with WIN SOURCE Solutions

-  Global Sourcing Solution
-  Obsolete Management
-  Cost Control Management
-  Shortage Management
-  Alternative Solution
-  Excess Inventory Management