



**THE DATASHEET OF
XRP2525IDTR-1-F**



GENERAL DESCRIPTION

The XRP2525 and XRP2526 devices are respectively single and dual channel integrated high-side power distribution switches with independent enables and fault flags. A wide 1.8V to 5.5V input voltage range allows for operations from industry standard 1.8V, 3.3V and 5V power rails.

Optimized for USB V_{BUS} power distribution, the XRP2525 and XRP2526 are compliant with the latest USB 3.0 specification and can be used in any self or bus powered USB applications. The power-switch rise and fall times are controlled to minimize current surges during turn on/off.

The XRP2525 and XRP2526 are pin and function compatible to respectively Exar’s SP2525A and SP2526A.

Built-in over current, under voltage lockout (UVLO), reverse current and over temperature protections insure safe operations under abnormal operating conditions.

XRP2525 and XRP2526 are offered in a RoHS compliant “green”/halogen free 8-pin NSOIC package.

APPLICATIONS

- Self Powered USB 2.0 and 3.0 Hubs
- USB Compliant V_{BUS} Power Distribution
- Audio-Video Equipments
- Generic Power Switching

FEATURES

- **Single/Dual Channel Current Switch**
 - 900mA per channel capable
 - 1.15A Over-current Limit
 - 1.8V to 5.5V Input Voltage Range
- **USB 2.0/3.0 Compliant**
- **Active High or Low Individual Enable**
- **Individual Channel Fault Flag Indicator**
- **Under voltage Lockout, Reverse Current and Thermal Shutdown Protection**
- **RoHS Compliant, Green/Halogen Free 8-Pin NSOIC Package**

XRP2526 is available, XRP2525 is obsolete

TYPICAL APPLICATION DIAGRAM

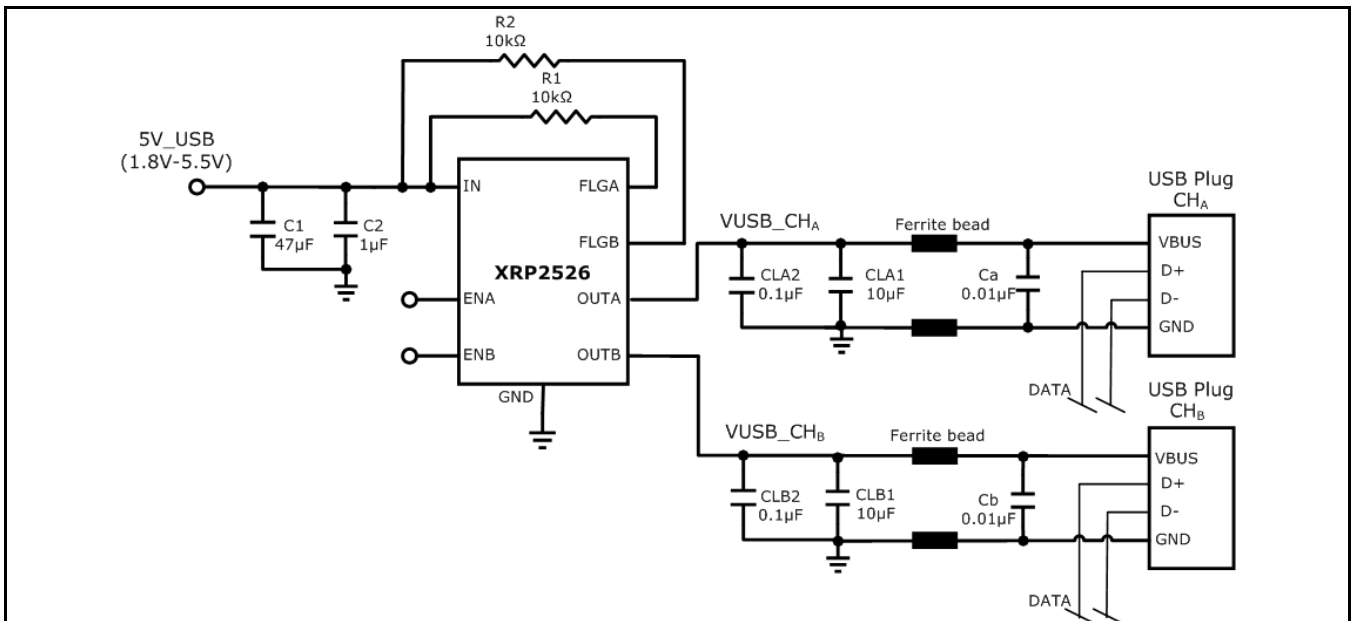

Fig. 1: XRP2526 Application Diagram



ABSOLUTE MAXIMUM RATINGS

These are stress ratings only and functional operation of the device at these ratings or any other above those indicated in the operation sections of the specifications below is not implied. Exposure to absolute maximum rating conditions for extended periods of time may affect reliability.

V_{IN}..... -0.3V to 7.0V
 V_{EN}, V_{FLG} 7.0V
 Storage Temperature..... -65°C to 150°C
 Power Dissipation Internally Limited
 Lead Temperature (Soldering, 10 sec) 300°C
 ESD Rating (HBM - Human Body Model) 2kV
 ESD Rating (MM - Machine Model)200V

OPERATING RATINGS

Input Voltage Range V_{IN}..... 1.75V to 5.5V
 Junction Temperature Range-40°C to 125°C
 Thermal Resistance θ_{JA} 128.4°C/W

ELECTRICAL SPECIFICATIONS

Specifications are for an Operating Junction Temperature of T_J = 25°C only; limits applying over the full Operating Junction Temperature range are denoted by a “•”. Minimum and Maximum limits are guaranteed through test, design, or statistical correlation. Typical values represent the most likely parametric norm at T_J = 25°C, and are provided for reference purposes only. Unless otherwise indicated, 1.8V to 5.5V, C_{IN} = 47µF//1µF, C_{OUT} = 10µF, T_J = -40°C to 125°C.

Parameter	Min.	Typ.	Max.	Units	Conditions
Input Supply Voltage	1.8		5.5	V	•
Input Quiescent Current		80	150	µA	• XRP2526 (Both Channels enabled) V _{IN} =5V, I _{OUT1} = I _{OUT2} =0mA
Input Quiescent Current		52	100	µA	• XRP2525 & XRP2526 (1 Channel enabled) V _{IN} =5V, I _{OUT1} =0mA
Input Shutdown Current			3	µA	• V _{IN} =5V, Channel(s) disabled
Maximum Output Current per channel	900			mA	• XRP2525 and XRP2526
Output Leakage Current			10	µA	V _{IN} =5V, V _{OUT} =0V, Each channel, Switch off
Reverse Leakage Current			10	µA	V _{IN} =0V, V _{OUT} =5V, Each channel, Switch off
Output MOSFET Resistance		80	140	mΩ	• I _{OUT} =0.3A, Each channel
Output turn-on delay		1000		µs	V _{IN} =5V, R _L =10Ω, C _{OUT} =1µF, each output
Output turn-on rise time		2000	4000	µs	V _{IN} =5V, R _L =10Ω, C _{OUT} =1µF, each output
Output turn-off delay		10	20	µs	V _{IN} =5V, R _L =10Ω, C _{OUT} =1µF, each output
Output turn-off fall time		22	50	µs	V _{IN} =5V, R _L =10Ω, C _{OUT} =1µF, each output
Current limit threshold	0.90	1.15	1.40	A	• V _{IN} - V _{OUT} =0.3V, Internally set
Short Circuit Current Limit		0.66xI _{LIM}		A	V _{OUT} =0V
Output Voltage Short Circuit Detect Threshold		925		mV	Operates in short circuit current limit mode when output voltage is below threshold.
Safe Operating Area (SOA) Current Limit		3		A	
Over temperature shutdown threshold		135		°C	Temperature rising
Over temperature shutdown threshold hysteresis		10		°C	Temperature decreasing
Under-voltage lockout threshold	1.55	1.68	1.75	V	V _{IN} rising or falling
Under-voltage lockout hysteresis		50		mV	
FLG output logic low voltage		100	250	mV	I _{FLG} =10mA, V _{IN} =5.5V
FLG output high leakage			1	µA	
FLG blanking time		10		ms	
EN input logic high voltage	1.5			V	•
EN input logic low voltage			0.5	V	•
EN input leakage current	-1	0	1	µA	V _{EN} =0V or V _{EN} =5.5V

BLOCK DIAGRAM

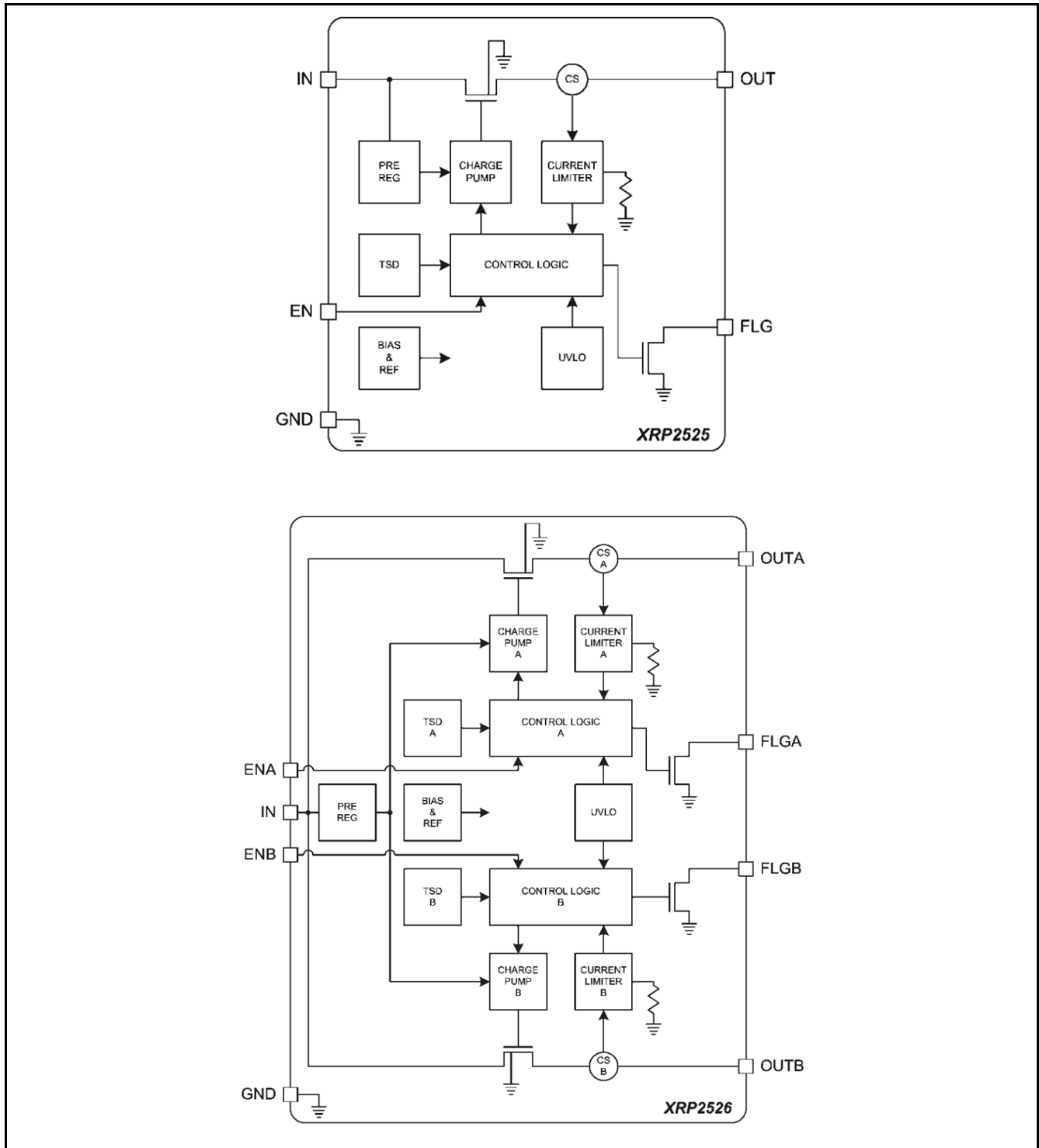

Fig. 2: XRP2525 and XRP2526 Block Diagrams

PIN ASSIGNMENT

Fig. 3: XRP2525 - XRP2526 Pin Assignment

PIN DESCRIPTION – XRP2525

Name	Pin Number	Description
EN	1	Channel Enable Input Active High for XRP2525-1 and Active Low for XRP2525-2
FLG	2	Error Flag Signal Active low open drain output. Active on over-current, over-temperature or UVLO conditions.
GND	3	Ground Signal
NC	4,5,6	No Connect
IN	7	Voltage Input Pin
OUT	8	Voltage Output Pin

PIN DESCRIPTION – XRP2526

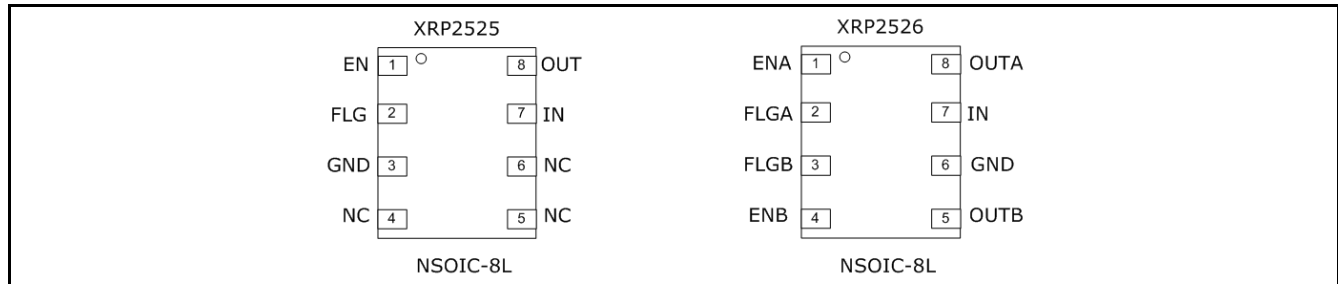
Name	Pin Number	Description
EN _x	1,4	Channel Enable Input Active High for XRP2526-1 and Active Low for XRP2526-2
FLG _x	2,3	Error Flag Signal Active low open drain output. Active on over-current, over-temperature or UVLO conditions.
GND	6	Ground Signal
IN	7	Voltage Input Pin
OUT _x	5,8	Voltage Output Pin

ORDERING INFORMATION^{(1), (2)}

Part Number	Temperature Range	Package	Packing Method	Lead Free ⁽³⁾	Note 1
XRP2526IDTR-1-F	-40°C ≤ T _A ≤ +85°C	NSOIC8	Tape & Reel	Yes	Dual Channel Active high
XRP2526EVB	XRP2526 Evaluation Board				

NOTES:

1. Refer to www.maxlinear.com/XRP2526 for most up-to-date Ordering Information.
2. XRP2525 (Single Channel) and XRP2526-2 (Active low Dual Channel) are obsolete.
3. Visit www.maxlinear.com for additional information on Environmental Rating.

TYPICAL PERFORMANCE CHARACTERISTICS

All data taken at $V_{IN} = 5V$, $C_{IN} = 47\mu F // 1\mu F$, $C_{OUT} = 10\mu F$, $T_J = T_A = 25^\circ C$, unless otherwise specified - Schematic and BOM from Application Information section of this datasheet.

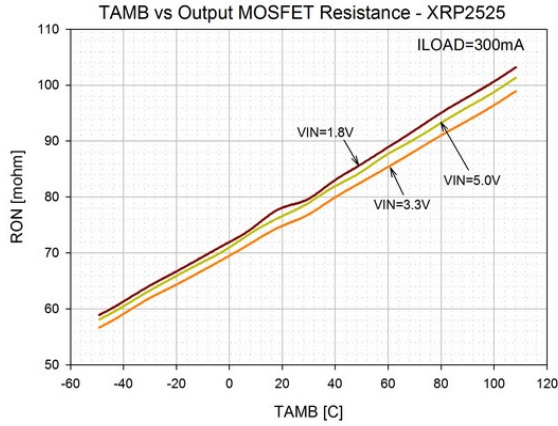

Fig. 4: Output On-Resistance vs. Temperature (XRP2525)

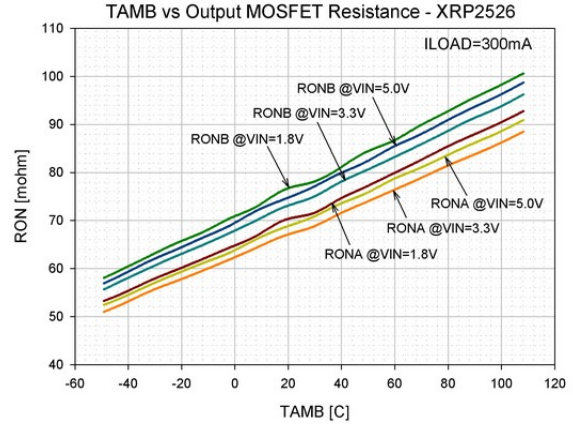

Fig. 5: Output On-Resistance vs. Temperature (XRP2526)

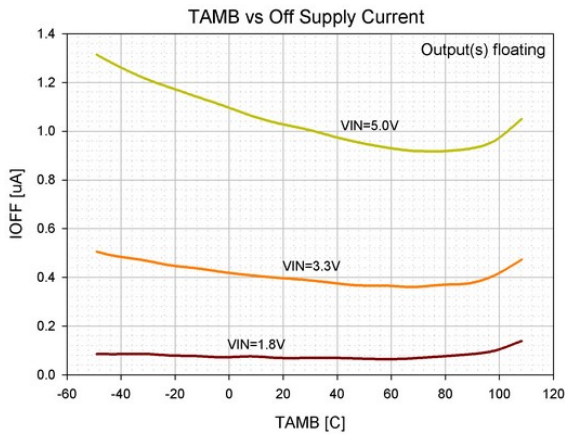

Fig. 6: Off Supply Current vs. Temperature

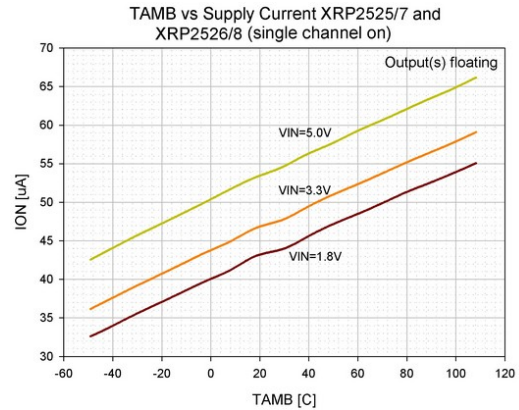

Fig. 7: Quiescent Current vs. Temperature XRP2525 and XRP2526 (1-channel on)

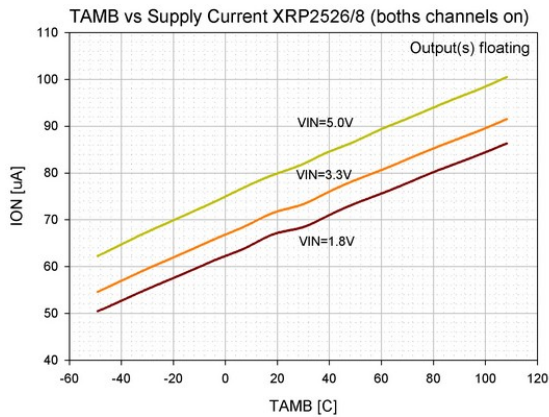

Fig. 8: Quiescent Current vs. Temperature XRP2526 (2-channels on)

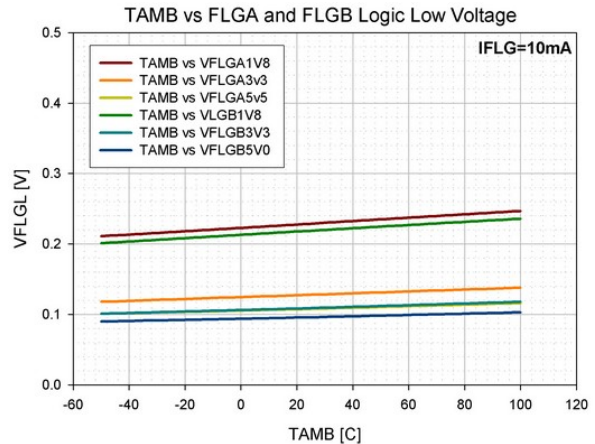

Fig. 9: FLG Logic Low Voltage vs. Temperature

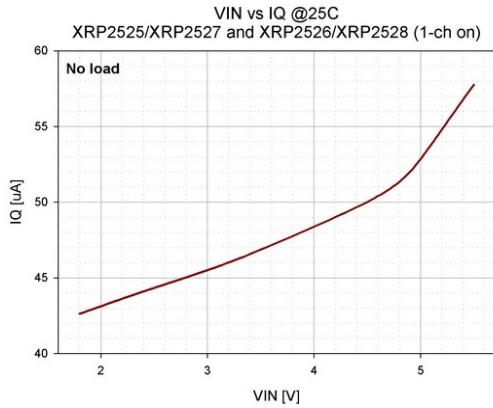

Fig. 10: Quiescent Current vs. Input Voltage XRP2525 and XRP2526 (1-channel on)

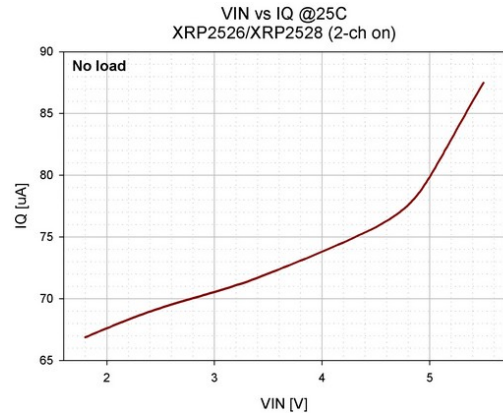

Fig. 11: Quiescent Current vs. Input Voltage XRP2526 (2-channels on)

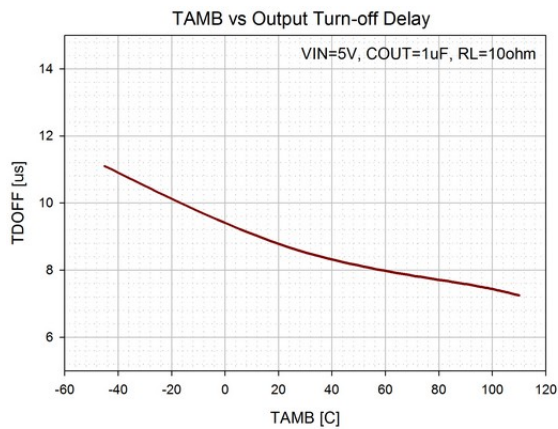

Fig. 12: Output Turn-Off Delay vs. Temperature

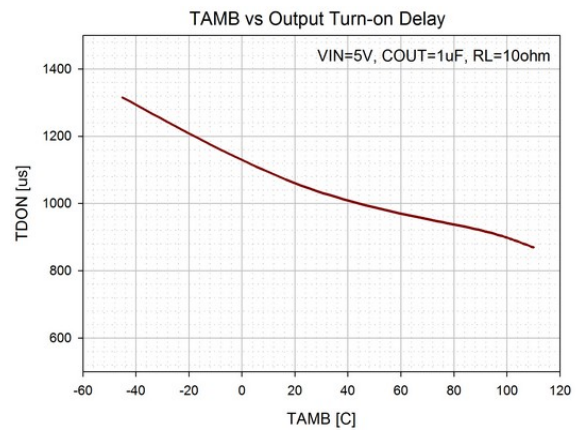

Fig. 13: Output Turn-on Delay vs. Temperature

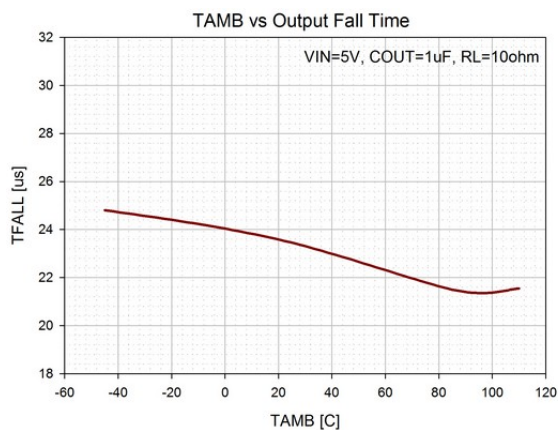

Fig. 14: Output Fall Time vs. Temperature

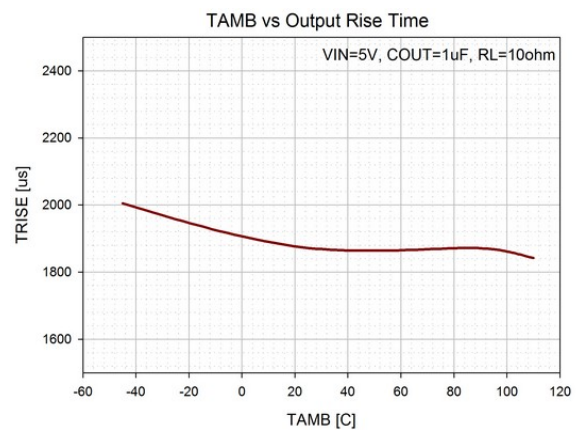

Fig. 15: Output Rise Time vs. Temperature

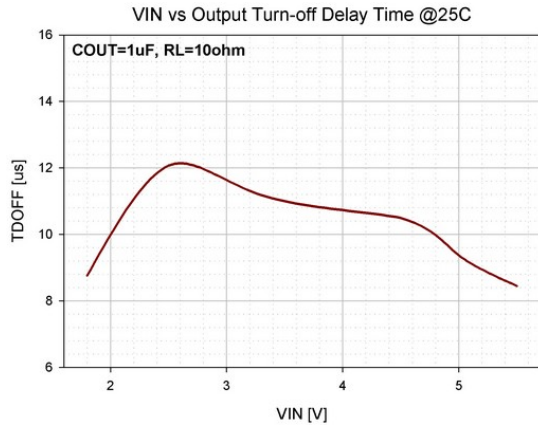

Fig. 16: Output Turn-Off Delay Time vs. Input Voltage

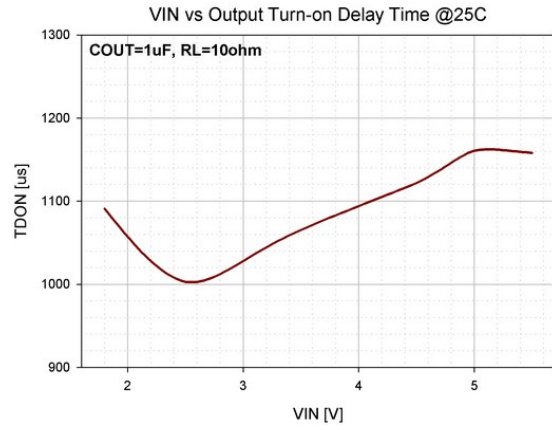

Fig. 17: Output Turn-On Delay Time vs. Input Voltage

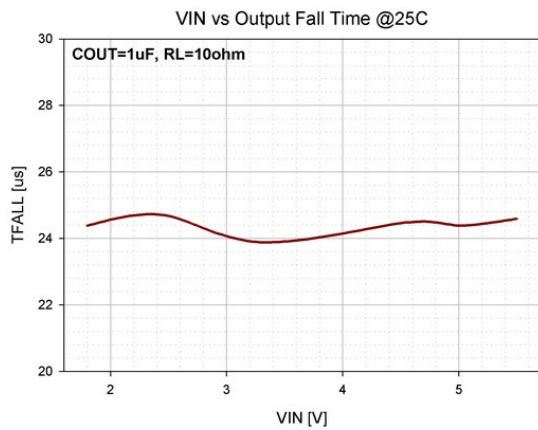

Fig. 18: Output Fall Time vs. Input Voltage

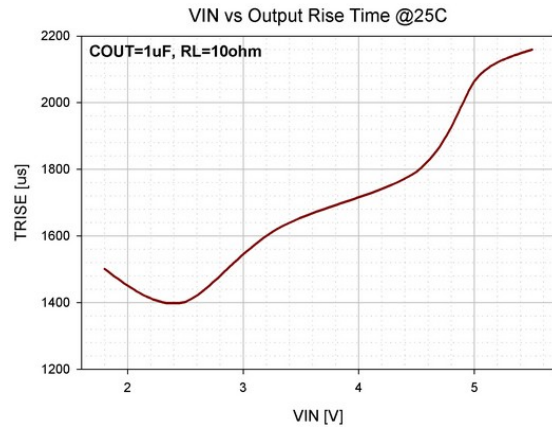

Fig. 19: Output Rise Time vs. Input Voltage

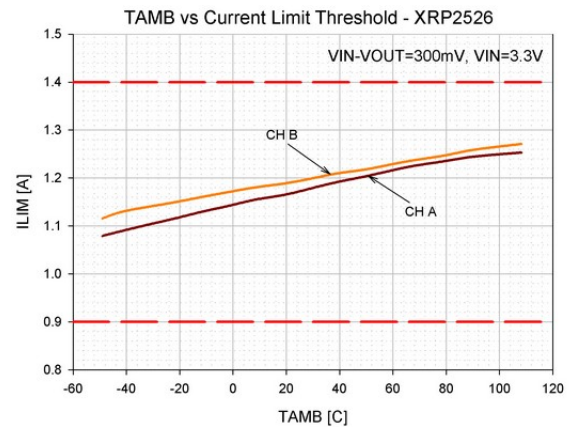
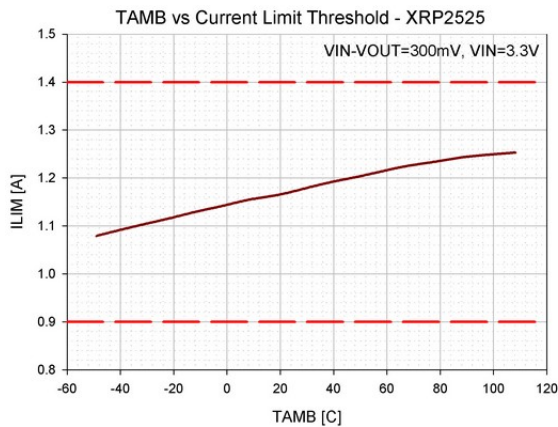

Fig. 20: Current Limit Threshold vs. Temperature (XRP2525) Fig. 21: Current Limit Threshold vs. Temperature (XRP2526)

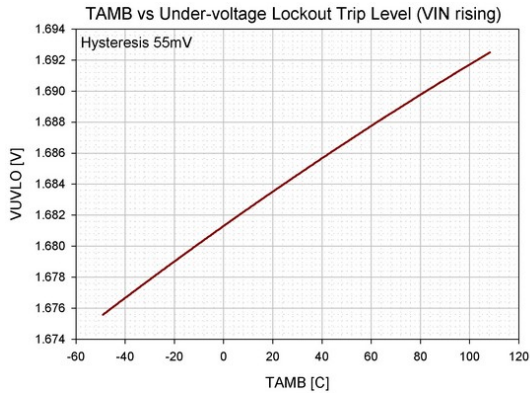

Fig. 22: Under-voltage lockout trip level vs. Temperature (VIN Rising)

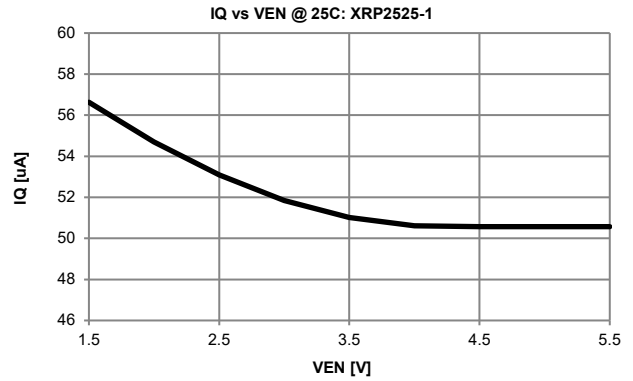

Fig. 23: Quiescent Current vs. Enable pin Voltage XRP2525-1

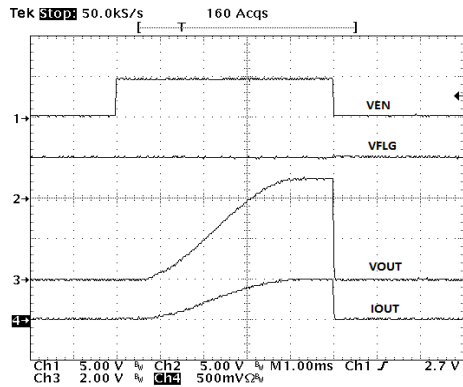

Fig. 24: Turn-On, Turn-Off Characteristics (XRP2526-1) COUT = 1uF, Rload = 10Ω

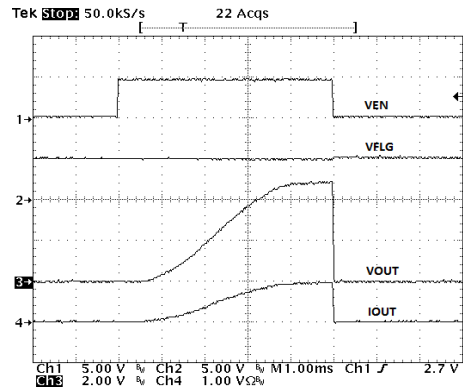

Fig. 25: Turn-On, Turn-Off Characteristics (XRP2526-1) COUT = 1uF, Rload = 5.1Ω

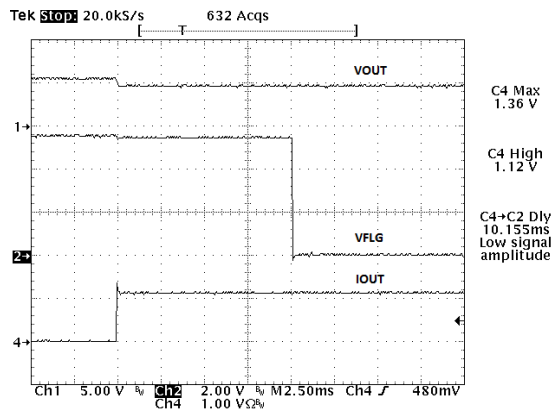

Fig. 26: Current Limit Operation (XRP2525-1):
VIN=5.5V, Rload = 3.9Ω

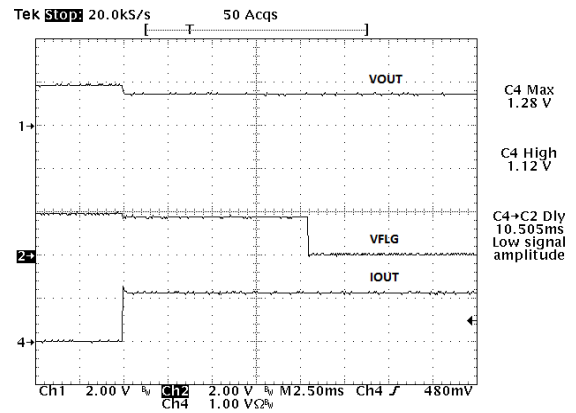

Fig. 27: Current Limit Operation (XRP2526-1):
VIN=1.8V, Rload = 1.5Ω

THEORY OF OPERATION

The XRP2525 and XRP2526 devices are respectively single and dual channel integrated high-side power distribution switches that can be used in any self or bus powered USB applications. They are compliant with the latest USB 3.0 specifications. The reverse current protection feature prevents current to flow from OUT to IN when the device is disabled.

INPUT & OUTPUT

Placing bulk capacitances of at least 47µF and 10µF at the input and output pins respectively reduces power supply transients under heavy current load conditions.

It is important to place a 1µF ceramic bypass capacitor from IN to GND as close as possible to the device in order to control supply transients.

Furthermore, bypassing the output pin with a 0.1µF to 1µF ceramic capacitor improves the device response to short-circuit transients.

ERROR FLAG

The error flag signal (FLG_x output pin) is an open-drain output and is pulled low (active low) upon detection of the following conditions:

- Over-current condition
- Over-temperature condition
- Under voltage lockout condition

Over-temperature and under voltage lockout conditions are flagged immediately while the over – current condition is reported only if this condition persists continuously for longer than the blanking time of 10ms. The blanking time prevents erroneous reporting of current faults due to brief output current spikes.

Once activated, the error flag signal remains low until all fault conditions have been removed and is independent for each individual channel.

CURRENT LIMIT

The current limit threshold is preset internally. It protects the output MOSFET switches from

damages resulting from undesirable short circuit conditions or excess inrush current, which is often encountered during hot plug-in. The low limit of the current limit threshold of the XRP2525 and XRP2526 allows a minimum current of 0.9A through the MOSFET switches.

When an overcurrent condition is detected, the output current is limited to a constant current limit threshold value and output voltage is reduced accordingly. Triggering the current limit function is signaled by the Error Flag after 10ms of blanking time period.

UNDER-VOLTAGE LOCKOUT

Under-voltage lockout function (UVLO) keeps the internal power switch from being turned on until the power supply has reached at least 1.68V, even if the switch is enabled. Upon detection of an input voltage below approximately 1.68V, the power switch is turned off while a fault condition is reported by the error flag signal.

THERMAL PROTECTION

Internal thermal sensing circuitry monitors the operating temperature of the device for each channel independently. Upon detection of a temperature in excess of 135°C, the power switch for the given channel is disabled preventing any damages to the device while a fault condition is reported by the error flag signal. A built-in 10°C hysteresis allows the device to cool down to 125°C before resuming normal operations on the faulty channel at which point the error flag signal is cleared.

TEST CIRCUIT

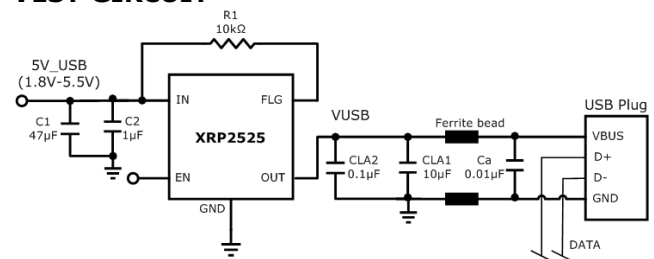

PACKAGE SPECIFICATION

8-PIN NSOIC

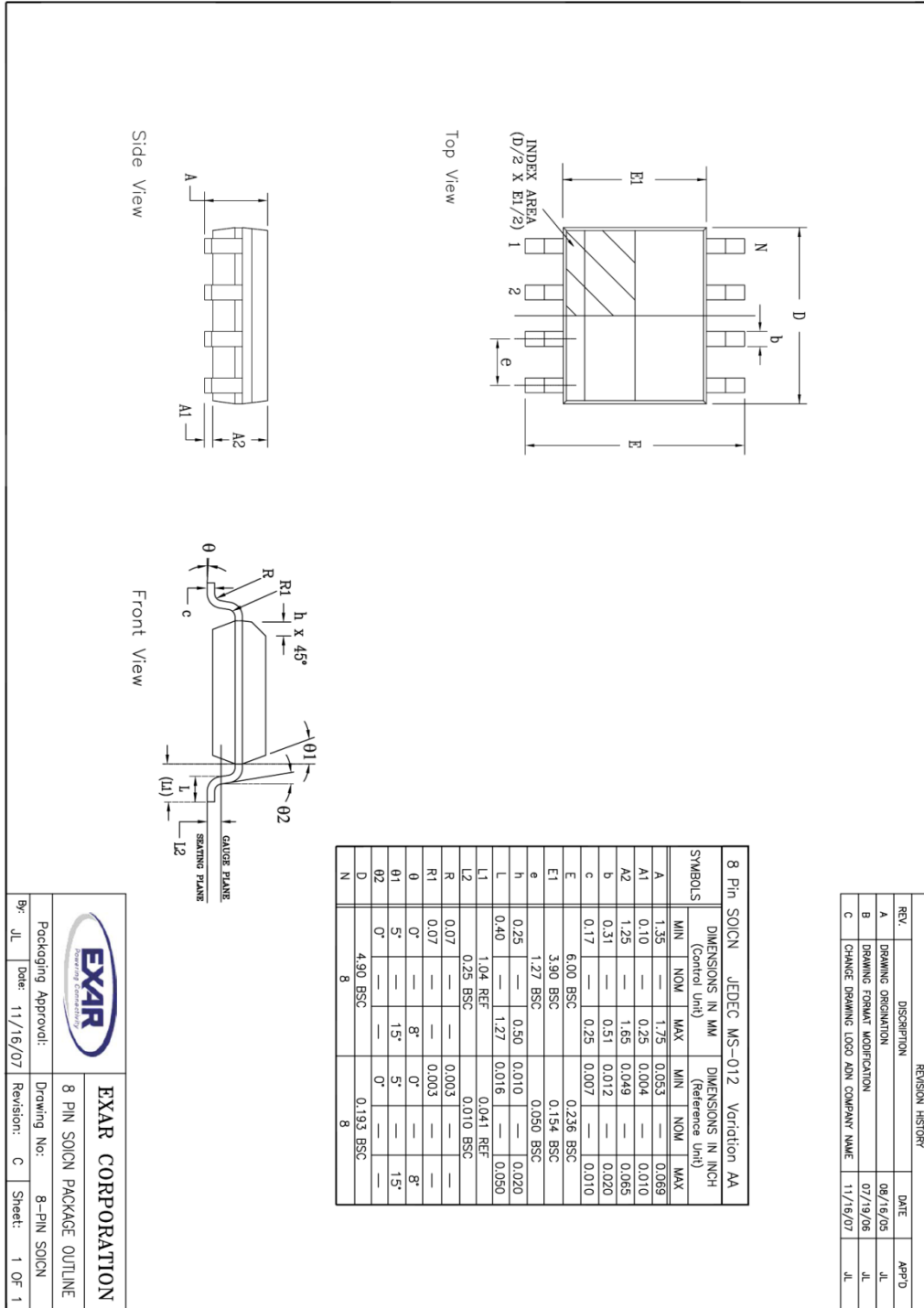

REVISION HISTORY			
REV.	DESCRIPTION	DATE	APP'D
A	DRAWING ORIGINATOR	08/16/05	JL
B	DRAWING FORMAT MODIFICATION	07/19/06	JL
C	CHANGE DRAWING LOGO AND COMPANY NAME	11/16/07	JL

		EXAR CORPORATION	
Packaging Approver:		Drawing No.: 8 PIN SOICN PACKAGE OUTLINE	
By: JL	Date: 11/16/07	Revision: C	Sheet: 1 OF 1



REVISION HISTORY

Revision	Date	Description
1.0.0	05/13/2011	Initial release of datasheet
1.1.0	07/14/2011	Corrections of typographical errors
1.1.1	11/04/2019	Updated to MaxLinear logo. Updated Ordering Information.



CORPORATE HEADQUARTERS:

5966 La Place Court
Suite 100
Carlsbad, CA 92008
Tel.: +1 (760) 692-0711
Fax: +1 (760) 444-8598
www.maxlinear.com

The content of this document is furnished for informational use only, is subject to change without notice, and should not be construed as a commitment by Maxlinear, Inc. Maxlinear, Inc. Assumes no responsibility or liability for any errors or inaccuracies that may appear in the informational content contained in this guide. Complying with all applicable copyright laws is the responsibility of the user. Without limiting the rights under copyright, no part of this document may be reproduced into, stored in, or introduced into a retrieval system, or transmitted in any form or by any means (electronic, mechanical, photocopying, recording, or otherwise), or for any purpose, without the express written permission of Maxlinear, Inc.

Maxlinear, Inc. Does not recommend the use of any of its products in life support applications where the failure or malfunction of the product can reasonably be expected to cause failure of the life support system or to significantly affect its safety or effectiveness. Products are not authorized for use in such applications unless Maxlinear, Inc. Receives, in writing, assurances to its satisfaction that: (a) the risk of injury or damage has been minimized; (b) the user assumes all such risks; (c) potential liability of Maxlinear, Inc. Is adequately protected under the circumstances.

Maxlinear, Inc. May have patents, patent applications, trademarks, copyrights, or other intellectual property rights covering subject matter in this document. Except as expressly provided in any written license agreement from Maxlinear, Inc., the furnishing of this document does not give you any license to these patents, trademarks, copyrights, or other intellectual property.

Maxlinear, the Maxlinear logo, and any Maxlinear trademarks, MxL, Full-Spectrum Capture, FSC, G.now, AirPHY and the Maxlinear logo are all on the products sold, are all trademarks of Maxlinear, Inc. or one of Maxlinear's subsidiaries in the U.S.A. and other countries. All rights reserved. Other company trademarks and product names appearing herein are the property of their respective owners.

© 2011 - 2019 Maxlinear, Inc. All rights reserved.

Looking for pricing, stock, or lifecycle information?

Click below to explore more details on WIN SOURCE:

 [View XRP2525IDTR-1-F on WIN SOURCE](#)

 [Exar Corporation](#) Information

Optimize Your Supply Chain with WIN SOURCE Solutions

-  Global Sourcing Solution
-  Obsolete Management
-  Cost Control Management
-  Shortage Management
-  Alternative Solution
-  Excess Inventory Management