



**THE DATASHEET OF  
V70102SS05Q**



# V Series Power & Line Voltage Select Slide Switches

## Features/Benefits

- Ratings up to 10 AMPS
- Snap-in panel and PC mounting
- Actuators with screwdriver slot
- Quick connect terminals available
- RoHS compliant

## Typical Applications

- Appliances



## Specifications

CONTACT RATING: 10 GPA @ 125 V AC 50/60 Hz T85;  
 5 GPA @ 250 V AC 50/60 Hz T85;  
 2 (0.5)A @ 250 VAC 50/60 Hz T85;  
 4RA @ 30 VDC T85

ELECTRICAL LIFE: 10,000 make-and-break cycles at full load.

CONTACT RESISTANCE: Below 10 m Ω typ. initial  
 @ 2-4 V DC, 100 mA.

INSULATION RESISTANCE: 10<sup>9</sup> Ω min.

DIELECTRIC STRENGTH: 1,000 Vrms min. @ sea level.

OPERATING TEMPERATURE: -30°C to +85°C.

## Materials

HOUSING: 6/6 nylon (UL94V-2), black.

TOP PLATE: 6/6 nylon (UL94V-2), black.

ACTUATOR: Glass filled polyester (UL94V-0), '01 and 02' styles, black (standard); '12, 13 and 14' styles, red (standard).

CONTACTS: Copper, silver plated.

TERMINALS: Copper, silver plated.

CONTACT SPRING: Music wire or stainless steel.

TERMINAL SEAL: Epoxy.

**NOTE:** Any models supplied with Q, B or G contact material are RoHS compliant.

**NOTE:** Specifications and materials listed above are for switches with standard options. For information on specific and custom switches, consult Customer Service Center.



Slide

## Build-A-Switch

To order, simply select desired option from each category and place in the appropriate box. Available options are shown and described on pages I-34 through I-36. For additional options not shown in catalog, consult Customer Service Center.

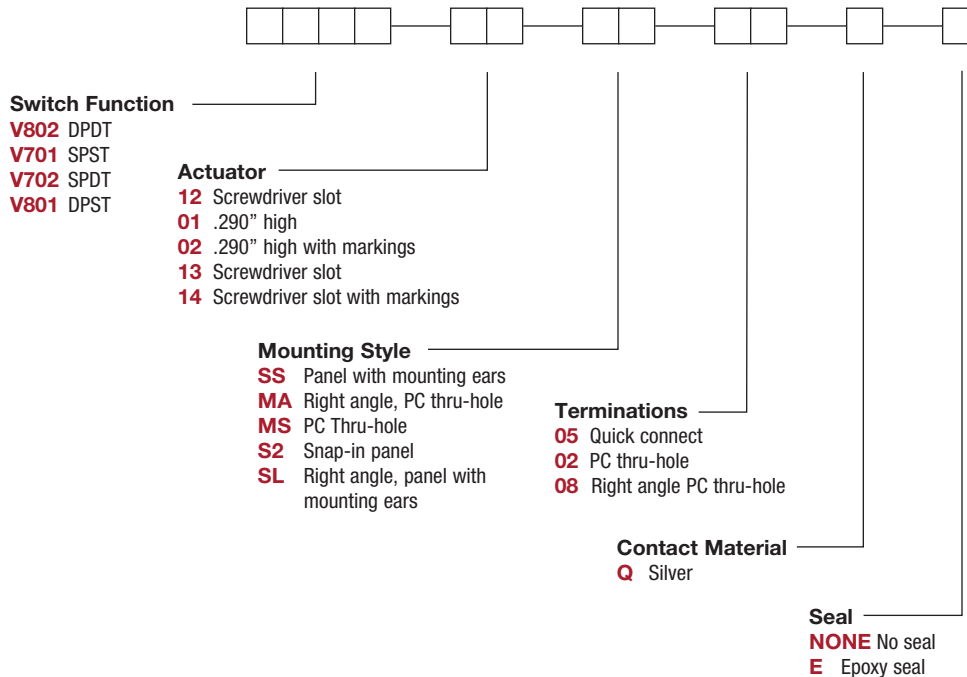

# V Series Power & Line Voltage Select Slide Switches

## SWITCH FUNCTION

NO. POLES	MODEL NO.	SWITCH FUNCTION	SCHEMATIC	AVAILABLE MOUNTING STYLES
SP	V701	SPST		ALL
	V702	SPDT		ALL

All models with all options.



Contacts make on side actuator thrown.

NO. POLES	MODEL NO.	SWITCH FUNCTION	SCHEMATIC	AVAILABLE MOUNTING STYLES
DP	V801	DPST		ALL
	V802	DPDT		ALL

## ACTUATOR

**12** SCREWDRIVER SLOT WITH MARKING

**01** .290" HIGH

**02** .290" HIGH WITH MARKINGS

**13** SCREWDRIVER SLOT NO MARKING

**14** SCREWDRIVER SLOT WITH MARKINGS

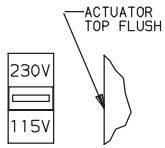

Actuator color is red with white 115V-230V markings (std.).

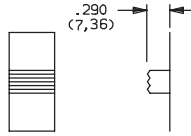

Actuator color is black.



markings are reversed on V702 and V802 models. Actuator color is black with white markings (std.).

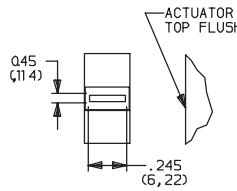

Actuator color is red.

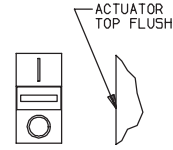

Markings are reversed on V702 and V802 models. Actuator color is red with white markings (std.). **Note:** Orientation of actuator markings and terminals.



## MOUNTING STYLE

**SS** PANEL WITH MOUNTING EARS



V80212SS05Q  
DPDT



PANEL MOUNTING



**AVAILABLE WITH:**  
Models: All.  
Terminations: 02 and 05

**MA** RIGHT ANGLE, PC THRU-HOLE



V80212MA08Q  
Horizontal Actuation  
DPDT

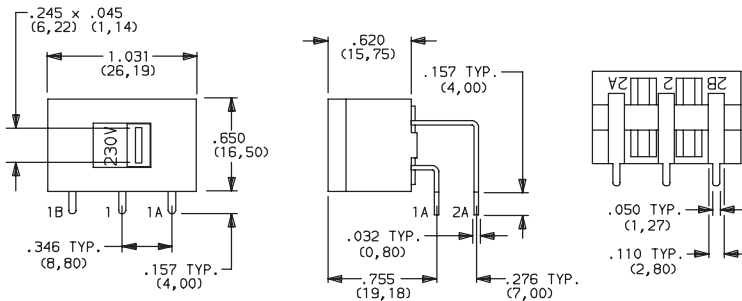

**AVAILABLE WITH:**

Models: All  
Terminations: 08

**PC MOUNTING**

PC mount, side actuated.  
For mounting information, see TERMINATIONS section, page I-36.



Dimensions are shown: Inch (mm)

Specifications and dimensions subject to change



# V Series Power & Line Voltage Select Slide Switches

## MOUNTING STYLE

### MS PC THRU-HOLE



**AVAILABLE WITH:**  
All models with 02 terminations

**PC MOUNTING**  
PC mount, top actuated.  
For mounting information,  
see TERMINATIONS section, page I-36.



V80212MS02Q  
DPDT

### SL RIGHT ANGLE PANEL WITH MOUNTING EARS

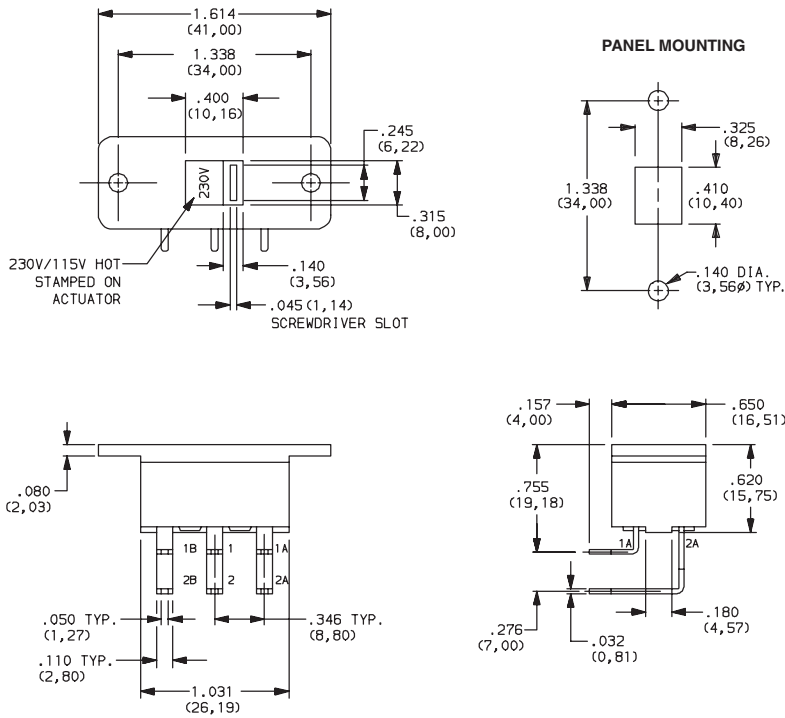

**AVAILABLE WITH:**  
All models with 08 terminations



V80213SL08Q  
Horizontal Actuation  
DPDT

### S2 SNAP-IN PANEL MOUNT

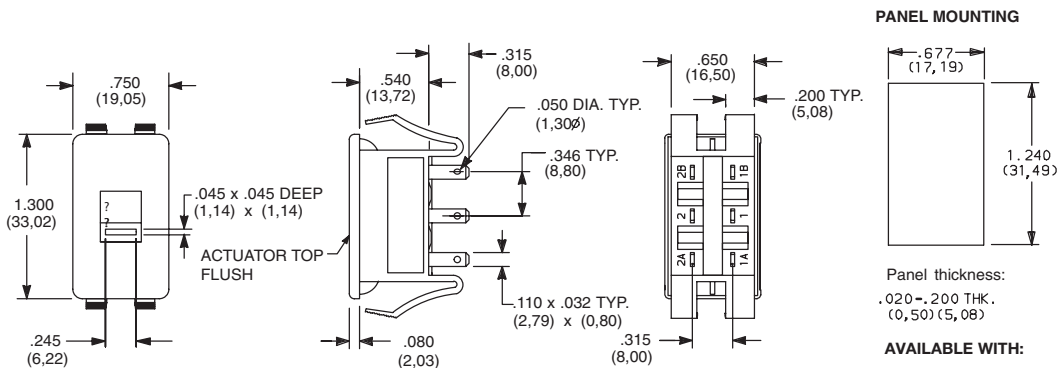

#### PANEL MOUNTING

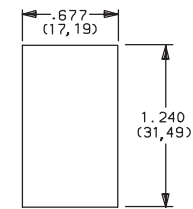

Panel thickness:  
.020-.200 THK.  
(0,50) (5,08)

**AVAILABLE WITH:**  
All models with 02 &  
05 terminations



V80212S205Q  
DPDT



Dimensions are shown: Inches (mm)  
Specifications and dimensions subject to change



Slide

# V Series Power & Line Voltage Select Slide Switches

## TERMINATIONS

### 05 QUICK CONNECT



.032 THK.  
(0,80)

Fits .110 in. quick connector.

### 02 PC THRU-HOLE

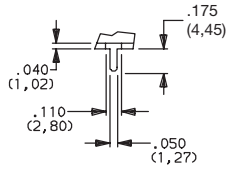

.032 THK.  
(0,80)

#### PC MOUNTING



MS, SS Mounting Styles.

### 08 PC THRU-HOLE

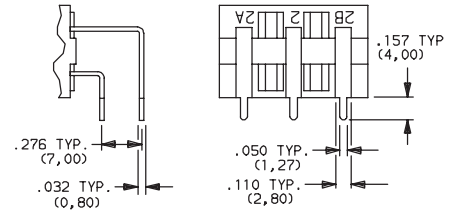

Not available with 'MS, SS or S2' mounting styles.

#### PC MOUNTING



MA, SL Mounting Styles.

## CONTACT MATERIAL

OPTION CODE	CONTACT MATERIAL	RATINGS	
Q	SILVER <sup>1</sup>	POWER	10 GPA @ 125 V AC 50/60 Hz T85; 5 GPA @ 250 V AC 50/60 Hz T85; 2 (0.5)A @ 250 VAC 50/60 Hz T85; 4RA @ 30 VDC T85

\* Note: See Technical Data section of this catalog for RoHS compliant and compatible definitions and specifications.

<sup>1</sup> CONTACTS & TERMINALS: Copper, silver plated (standard with all termination options).

All models   with all options.

**NOTE:** Any models supplied with Q contact material are RoHS compliant.

## SEAL

**NONE** NO SEAL

**E** EPOXY SEAL



Third Angle  
Projection

Dimensions are shown: Inch (mm)  
Specifications and dimensions subject to change



## Looking for pricing, stock, or lifecycle information?

Click below to explore more details on WIN SOURCE:

 [View V70102SS05Q on WIN SOURCE](#)

 [C&K Components](#) Information

## Optimize Your Supply Chain with WIN SOURCE Solutions

-  Global Sourcing Solution
-  Obsolete Management
-  Cost Control Management
-  Shortage Management
-  Alternative Solution
-  Excess Inventory Management