



**THE DATASHEET OF
TWL6032A2B4YFFT**



TWL6032 Fully Integrated Power Management with Power Path and Battery Charger

1 Device Overview

1.1 Features

- Five Highly Efficient Buck Converters
 - One 3 MHz, 0.6 to 2.1 V at 5.0 A, DVS-Capable
 - One 6 MHz, 0.6 to 2.1 V at 2.5 A, DVS-Capable
 - Three 6 MHz, 0.6 to 2.1 V at 1.1 A, One Is DVS-Capable
 - Extended Mode for Higher Output Voltages
- 11 General-Purpose Low-Dropout Voltage Regulators (LDOs)
 - Six 1.0 to 3.3 V at 0.2 A With Battery or Preregulated Supply:
 - One Can be Used as Vibrator Driver
 - One 1.0 to 3.3 V at 50 mA With Battery or Preregulated Supply
 - One Low-Noise 1.0 to 3.3 V at 50 mA With Battery or Preregulated Supply
 - One 3.3 V at 100 mA USB LDO
 - Two LDOs for TWL6032 Internal Use
- USB OTG Module:
 - ID Detection, Accessory Charger Adapter (ACA) Support
 - Accessory Detection Protocol (ADP) Support
- Backup Battery Charger
- 12-Bit Sigma-Delta Analog-to-Digital Converter (ADC) With 19 Input Channels:
 - Seven External Input Channels
- 13-Bit Coulomb Counter With Four Programmable Integration Periods
- Low-Power Consumption:
 - 8 μ A in BACKUP State
 - 20 μ A in WAIT-ON State
 - 110 μ A in SLEEP State, With Two DC-DC Converters Active
- Real-Time Clock (RTC) With Timer and Alarm Wake-Up:
 - Three Buffered 32-kHz Outputs
- SIM and SD/MMC Card Detections
- Two Digital PWM Outputs
- Thermal Monitoring:
 - High-Temperature Warning
 - Thermal Shutdown
- Control:
 - Configurable Power-Up and Power-Down Sequences (OTP Memory)
 - Configurable Sequences Between SLEEP and ACTIVE States (OTP Memory)
 - Three Digital Output Signals that can be Included in the Startup Sequence to Control External Devices
 - Two Inter-Integrated Circuit (I²C) Interfaces
 - All Resources Configurable by I²C
- System Voltage Regulator and Battery Charger With Power Path From USB:
 - Input Current Limit to Comply With USB Standard
 - 3-MHz Switched-Mode Regulator With Integrated Power FET for up to 2.0-A Current
 - Dedicated Control Loop for Battery Current and Voltage
 - External Low-Ohmic FET for Power Path and Battery Charging
 - Boost Mode Operation for USB OTG
 - Supplement Mode to Deliver Current From Battery During Power Path Operation
 - Charger for Single-Cell Li-Ion and Li-Polymer Battery Packs
 - Safety Timer and Reset Control
 - Thermal Protection
 - Input/Output Overvoltage Protection
 - Charging Indicator LED Driver
 - Compliant With:
 - USB 2.0
 - OTG and EH 2.0
 - USB Battery Charging 1.2
 - YD/T 1591-2006
 - Japanese Battery Charging Guidelines (JEITA)
- Battery Voltage Range From 2.5 to 5.5 V
- Package 5.21-mm \times 5.36-mm 155-Pin WCSP



1.2 Applications

- Mobile Phones and Smart Phones
- Tablets
- Gaming Handsets
- Portable Media Players
- Portable Navigation Systems
- Handheld Devices

1.3 Description

The TWL6032 device is an integrated power-management integrated circuit (PMIC) for applications powered by a rechargeable battery. The device provides five configurable step-down converters with a current capability of up to 5.0 A for memory, processor core, I/O, auxiliary, preregulation for LDOs, and so forth. The device also contains nine LDO regulators for external use that can be supplied from a battery or a preregulated supply. The power-up and power-down controller is configurable and can support any power-up or power-down sequence (programmed in OTP memory). The RTC provides three 32-kHz clock outputs: seconds, minutes, hours, day, month, and year information; as well as alarm wakeup and timer. The TWL6032 device supports 32-kHz clock generation based on a crystal oscillator.

The device integrates a switched-mode system supply regulator from a USB connector. The switched-mode regulator includes power paths from the USB and battery with supplemental mode for immediate startup, even with an empty battery. The battery switch uses an external low-ohmic PMOS transistor allowing minimal serial resistance during fast charging and when operating from battery. The device can also be used without the external PMOS transistor; in this case, the battery is always tied to the system supply and the switched-mode regulator is used for battery charging.

The TWL6032 device is available in a 155-pin WCSP package, 5.21 mm × 5.36 mm with a 0.4-mm ball pitch.

Figure 1-1 shows the TWL6032 device block diagram.

Table 1-1. Device Information⁽¹⁾

PART NUMBER	PACKAGE	BODY SIZE
TWL6032A1Bx	YFF (155)	5.21 mm × 5.36 mm
TWL6032A2Bx	YFF (155)	5.21 mm × 5.36 mm

(1) For more information, see [Section 3](#), *Mechanical Packaging and Orderable Information*.

1.4 Functional Block Diagram

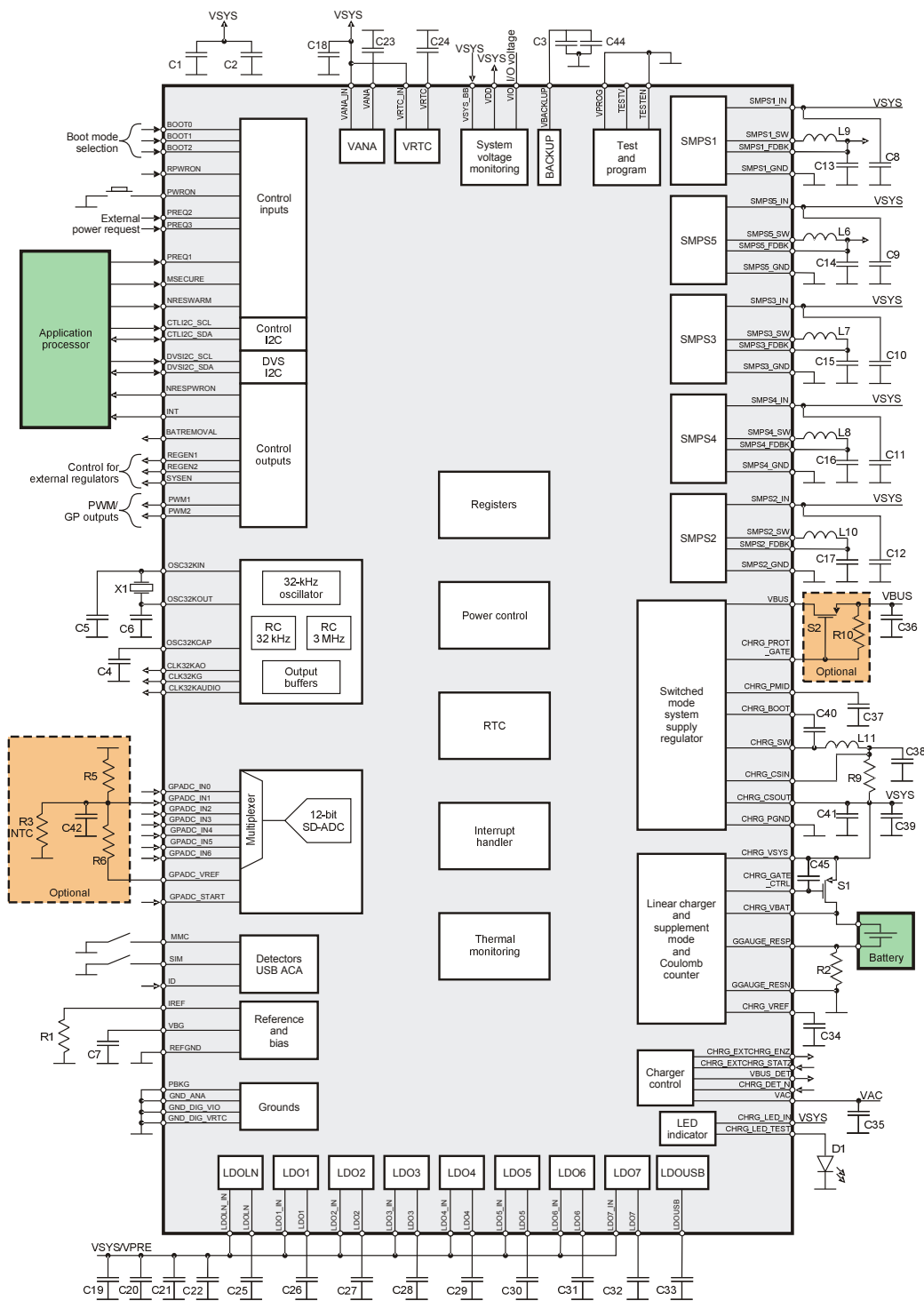

Figure 1-1. TWL6032 Device Block Diagram

For the complete TWL6032 data sheet (SWCS057), contact your TI sales representative.

2 Revision History

NOTE: Page numbers for previous revisions may differ from page numbers in the current version.

Changes from Revision A (September 2012) to Revision B	Page
• Changed document to standard TI format.	1

3 Mechanical Packaging and Orderable Information

3.1 Packaging Information

The following pages include mechanical packaging and orderable information. This information is the most current data available for the designated devices. This data is subject to change without notice and revision of this document. For browser-based versions of this data sheet, refer to the left-hand navigation.

PACKAGING INFORMATION

Orderable Device	Status (1)	Package Type	Package Drawing	Pins	Package Qty	Eco Plan (2)	Lead/Ball Finish (6)	MSL Peak Temp (3)	Op Temp (°C)	Device Marking (4/5)	Samples
TWL6032A1B4YFFR	ACTIVE	DSBGA	YFF	155	3000	Green (RoHS & no Sb/Br)	SNAGCU	Level-1-260C-UNLIM	-40 to 85	TWL6032 A1B4	Samples
TWL6032A1B4YFFT	ACTIVE	DSBGA	YFF	155	250	Green (RoHS & no Sb/Br)	SNAGCU	Level-1-260C-UNLIM	-40 to 85	TWL6032 A1B4	Samples
TWL6032A1B6YFFR	ACTIVE	DSBGA	YFF	155	3000	Green (RoHS & no Sb/Br)	SNAGCU	Level-1-260C-UNLIM	-40 to 85	TWL6032 A1B6	Samples
TWL6032A2B0YFFR	ACTIVE	DSBGA	YFF	155	3000	Green (RoHS & no Sb/Br)	SNAGCU	Level-1-260C-UNLIM	-40 to 85	TWL6032 A2B0	Samples
TWL6032A2B0YFFT	ACTIVE	DSBGA	YFF	155	250	Green (RoHS & no Sb/Br)	SNAGCU	Level-1-260C-UNLIM	-40 to 85	TWL6032 A2B0	Samples
TWL6032A2B4YFFR	ACTIVE	DSBGA	YFF	155	3000	Green (RoHS & no Sb/Br)	SNAGCU	Level-1-260C-UNLIM	-40 to 85	TWL6032 A2B4	Samples
TWL6032A2B4YFFT	ACTIVE	DSBGA	YFF	155	250	Green (RoHS & no Sb/Br)	SNAGCU	Level-1-260C-UNLIM	-40 to 85	TWL6032 A2B4	Samples
TWL6032A2B6YFFR	ACTIVE	DSBGA	YFF	155	3000	Green (RoHS & no Sb/Br)	SNAGCU	Level-1-260C-UNLIM	-40 to 85	TWL6032 A2B6	Samples
TWL6032A2B7YFFR	ACTIVE	DSBGA	YFF	155	3000	Green (RoHS & no Sb/Br)	SNAGCU	Level-1-260C-UNLIM	-40 to 85	TWL6032 A2B7	Samples
TWL6032A2B7YFFT	ACTIVE	DSBGA	YFF	155	250	Green (RoHS & no Sb/Br)	SNAGCU	Level-1-260C-UNLIM	-40 to 85	TWL6032 A2B7	Samples
TWL6032A2B8YFFR	ACTIVE	DSBGA	YFF	155	3000	Green (RoHS & no Sb/Br)	SNAGCU	Level-1-260C-UNLIM	-40 to 85	TWL6032 A2B8	Samples
TWL6032A2B8YFFT	ACTIVE	DSBGA	YFF	155	250	Green (RoHS & no Sb/Br)	SNAGCU	Level-1-260C-UNLIM	-40 to 85	TWL6032 A2B8	Samples
TWL6032A2BEYFFT	ACTIVE	DSBGA	YFF	155	250	Green (RoHS & no Sb/Br)	SNAGCU	Level-1-260C-UNLIM	-40 to 85	TWL6032 A2BE	Samples

(1) The marketing status values are defined as follows:

ACTIVE: Product device recommended for new designs.

LIFEBUY: TI has announced that the device will be discontinued, and a lifetime-buy period is in effect.

NRND: Not recommended for new designs. Device is in production to support existing customers, but TI does not recommend using this part in a new design.

PREVIEW: Device has been announced but is not in production. Samples may or may not be available.

OBSOLETE: TI has discontinued the production of the device.

⁽²⁾ Eco Plan - The planned eco-friendly classification: Pb-Free (RoHS), Pb-Free (RoHS Exempt), or Green (RoHS & no Sb/Br) - please check <http://www.ti.com/productcontent> for the latest availability information and additional product content details.

TBD: The Pb-Free/Green conversion plan has not been defined.

Pb-Free (RoHS): TI's terms "Lead-Free" or "Pb-Free" mean semiconductor products that are compatible with the current RoHS requirements for all 6 substances, including the requirement that lead not exceed 0.1% by weight in homogeneous materials. Where designed to be soldered at high temperatures, TI Pb-Free products are suitable for use in specified lead-free processes.

Pb-Free (RoHS Exempt): This component has a RoHS exemption for either 1) lead-based flip-chip solder bumps used between the die and package, or 2) lead-based die adhesive used between the die and leadframe. The component is otherwise considered Pb-Free (RoHS compatible) as defined above.

Green (RoHS & no Sb/Br): TI defines "Green" to mean Pb-Free (RoHS compatible), and free of Bromine (Br) and Antimony (Sb) based flame retardants (Br or Sb do not exceed 0.1% by weight in homogeneous material)

⁽³⁾ MSL, Peak Temp. - The Moisture Sensitivity Level rating according to the JEDEC industry standard classifications, and peak solder temperature.

⁽⁴⁾ There may be additional marking, which relates to the logo, the lot trace code information, or the environmental category on the device.

⁽⁵⁾ Multiple Device Markings will be inside parentheses. Only one Device Marking contained in parentheses and separated by a "~" will appear on a device. If a line is indented then it is a continuation of the previous line and the two combined represent the entire Device Marking for that device.

⁽⁶⁾ Lead/Ball Finish - Orderable Devices may have multiple material finish options. Finish options are separated by a vertical ruled line. Lead/Ball Finish values may wrap to two lines if the finish value exceeds the maximum column width.

Important Information and Disclaimer: The information provided on this page represents TI's knowledge and belief as of the date that it is provided. TI bases its knowledge and belief on information provided by third parties, and makes no representation or warranty as to the accuracy of such information. Efforts are underway to better integrate information from third parties. TI has taken and continues to take reasonable steps to provide representative and accurate information but may not have conducted destructive testing or chemical analysis on incoming materials and chemicals. TI and TI suppliers consider certain information to be proprietary, and thus CAS numbers and other limited information may not be available for release.

In no event shall TI's liability arising out of such information exceed the total purchase price of the TI part(s) at issue in this document sold by TI to Customer on an annual basis.

TAPE AND REEL INFORMATION



QUADRANT ASSIGNMENTS FOR PIN 1 ORIENTATION IN TAPE



*All dimensions are nominal

Device	Package Type	Package Drawing	Pins	SPQ	Reel Diameter (mm)	Reel Width W1 (mm)	A0 (mm)	B0 (mm)	K0 (mm)	P1 (mm)	W (mm)	Pin1 Quadrant
TWL6032A1B4YFFR	DSBGA	YFF	155	3000	330.0	12.4	5.35	5.49	0.86	8.0	12.0	Q1
TWL6032A1B4YFFT	DSBGA	YFF	155	250	180.0	12.4	5.35	5.49	0.86	8.0	12.0	Q1
TWL6032A1B6YFFR	DSBGA	YFF	155	3000	330.0	12.4	5.35	5.49	0.86	8.0	12.0	Q1
TWL6032A2B0YFFR	DSBGA	YFF	155	3000	330.0	12.4	5.35	5.49	0.86	8.0	12.0	Q1
TWL6032A2B0YFFT	DSBGA	YFF	155	250	180.0	12.4	5.35	5.49	0.86	8.0	12.0	Q1
TWL6032A2B4YFFR	DSBGA	YFF	155	3000	330.0	12.4	5.35	5.49	0.86	8.0	12.0	Q1
TWL6032A2B4YFFT	DSBGA	YFF	155	250	180.0	12.4	5.35	5.49	0.86	8.0	12.0	Q1
TWL6032A2B6YFFR	DSBGA	YFF	155	3000	330.0	12.4	5.35	5.49	0.86	8.0	12.0	Q1
TWL6032A2B7YFFR	DSBGA	YFF	155	3000	330.0	12.4	5.35	5.49	0.86	8.0	12.0	Q1
TWL6032A2B7YFFT	DSBGA	YFF	155	250	180.0	12.4	5.35	5.49	0.86	8.0	12.0	Q1
TWL6032A2B8YFFR	DSBGA	YFF	155	3000	330.0	12.4	5.35	5.49	0.86	8.0	12.0	Q1
TWL6032A2B8YFFT	DSBGA	YFF	155	250	180.0	12.4	5.35	5.49	0.86	8.0	12.0	Q1
TWL6032A2BEYFFT	DSBGA	YFF	155	250	180.0	12.4	5.35	5.49	0.86	8.0	12.0	Q1

TAPE AND REEL BOX DIMENSIONS

*All dimensions are nominal

Device	Package Type	Package Drawing	Pins	SPQ	Length (mm)	Width (mm)	Height (mm)
TWL6032A1B4YFFR	DSBGA	YFF	155	3000	367.0	367.0	35.0
TWL6032A1B4YFFT	DSBGA	YFF	155	250	182.0	182.0	20.0
TWL6032A1B6YFFR	DSBGA	YFF	155	3000	367.0	367.0	35.0
TWL6032A2B0YFFR	DSBGA	YFF	155	3000	367.0	367.0	35.0
TWL6032A2B0YFFT	DSBGA	YFF	155	250	182.0	182.0	20.0
TWL6032A2B4YFFR	DSBGA	YFF	155	3000	367.0	367.0	35.0
TWL6032A2B4YFFT	DSBGA	YFF	155	250	182.0	182.0	20.0
TWL6032A2B6YFFR	DSBGA	YFF	155	3000	367.0	367.0	35.0
TWL6032A2B7YFFR	DSBGA	YFF	155	3000	367.0	367.0	35.0
TWL6032A2B7YFFT	DSBGA	YFF	155	250	182.0	182.0	20.0
TWL6032A2B8YFFR	DSBGA	YFF	155	3000	367.0	367.0	35.0
TWL6032A2B8YFFT	DSBGA	YFF	155	250	182.0	182.0	20.0
TWL6032A2BEYFFT	DSBGA	YFF	155	250	182.0	182.0	20.0

YFF (R-XBGA-N155)

DIE-SIZE BALL GRID ARRAY

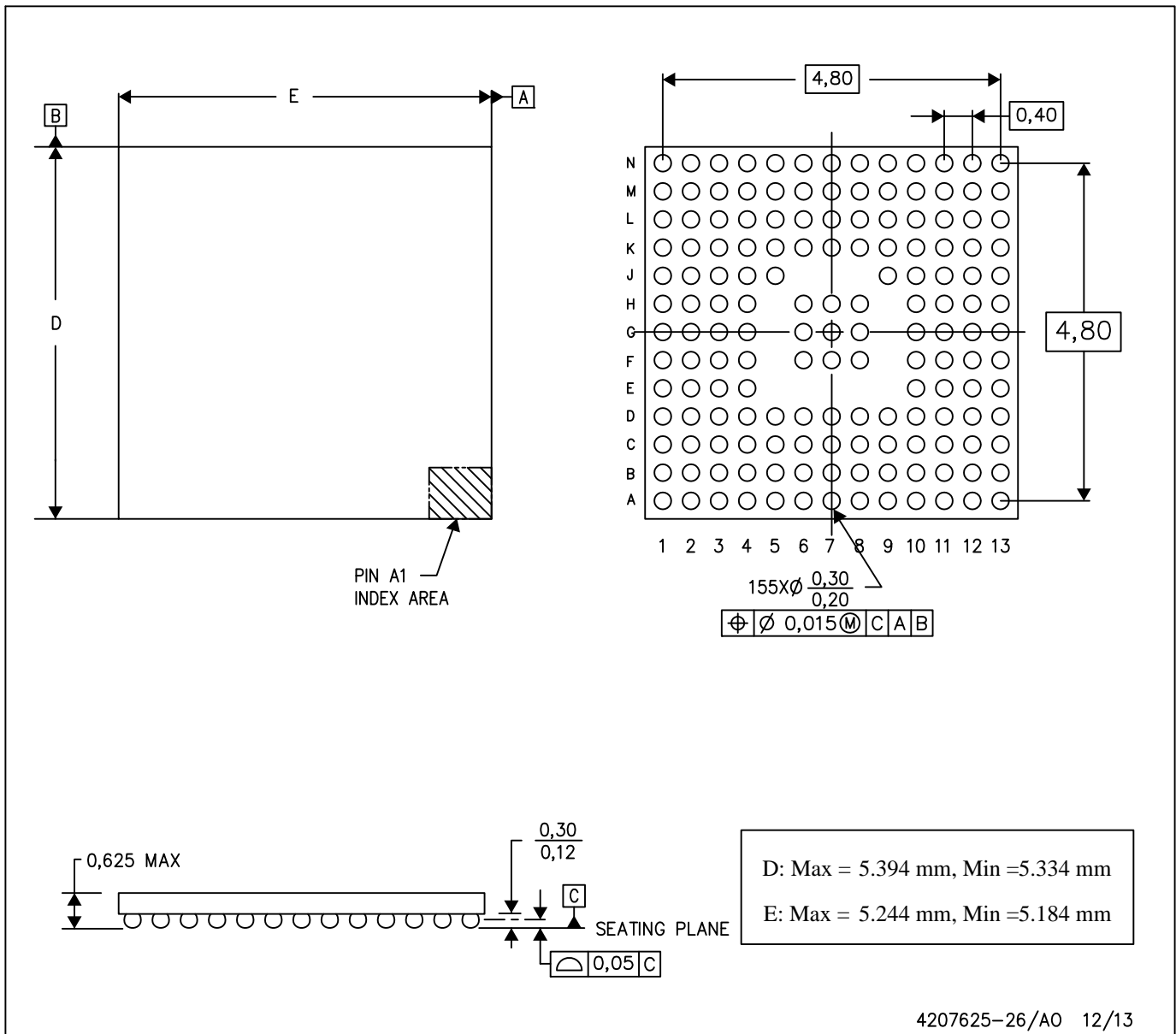

- NOTES: A. All linear dimensions are in millimeters. Dimensioning and tolerancing per ASME Y14.5M-1994.
 B. This drawing is subject to change without notice.
 C. NanoFree™ package configuration.

NanoFree is a trademark of Texas Instruments.

IMPORTANT NOTICE FOR TI DESIGN INFORMATION AND RESOURCES

Texas Instruments Incorporated ("TI") technical, application or other design advice, services or information, including, but not limited to, reference designs and materials relating to evaluation modules, (collectively, "TI Resources") are intended to assist designers who are developing applications that incorporate TI products; by downloading, accessing or using any particular TI Resource in any way, you (individually or, if you are acting on behalf of a company, your company) agree to use it solely for this purpose and subject to the terms of this Notice.

TI's provision of TI Resources does not expand or otherwise alter TI's applicable published warranties or warranty disclaimers for TI products, and no additional obligations or liabilities arise from TI providing such TI Resources. TI reserves the right to make corrections, enhancements, improvements and other changes to its TI Resources.

You understand and agree that you remain responsible for using your independent analysis, evaluation and judgment in designing your applications and that you have full and exclusive responsibility to assure the safety of your applications and compliance of your applications (and of all TI products used in or for your applications) with all applicable regulations, laws and other applicable requirements. You represent that, with respect to your applications, you have all the necessary expertise to create and implement safeguards that (1) anticipate dangerous consequences of failures, (2) monitor failures and their consequences, and (3) lessen the likelihood of failures that might cause harm and take appropriate actions. You agree that prior to using or distributing any applications that include TI products, you will thoroughly test such applications and the functionality of such TI products as used in such applications. TI has not conducted any testing other than that specifically described in the published documentation for a particular TI Resource.

You are authorized to use, copy and modify any individual TI Resource only in connection with the development of applications that include the TI product(s) identified in such TI Resource. NO OTHER LICENSE, EXPRESS OR IMPLIED, BY ESTOPPEL OR OTHERWISE TO ANY OTHER TI INTELLECTUAL PROPERTY RIGHT, AND NO LICENSE TO ANY TECHNOLOGY OR INTELLECTUAL PROPERTY RIGHT OF TI OR ANY THIRD PARTY IS GRANTED HEREIN, including but not limited to any patent right, copyright, mask work right, or other intellectual property right relating to any combination, machine, or process in which TI products or services are used. Information regarding or referencing third-party products or services does not constitute a license to use such products or services, or a warranty or endorsement thereof. Use of TI Resources may require a license from a third party under the patents or other intellectual property of the third party, or a license from TI under the patents or other intellectual property of TI.

TI RESOURCES ARE PROVIDED "AS IS" AND WITH ALL FAULTS. TI DISCLAIMS ALL OTHER WARRANTIES OR REPRESENTATIONS, EXPRESS OR IMPLIED, REGARDING TI RESOURCES OR USE THEREOF, INCLUDING BUT NOT LIMITED TO ACCURACY OR COMPLETENESS, TITLE, ANY EPIDEMIC FAILURE WARRANTY AND ANY IMPLIED WARRANTIES OF MERCHANTABILITY, FITNESS FOR A PARTICULAR PURPOSE, AND NON-INFRINGEMENT OF ANY THIRD PARTY INTELLECTUAL PROPERTY RIGHTS.

TI SHALL NOT BE LIABLE FOR AND SHALL NOT DEFEND OR INDEMNIFY YOU AGAINST ANY CLAIM, INCLUDING BUT NOT LIMITED TO ANY INFRINGEMENT CLAIM THAT RELATES TO OR IS BASED ON ANY COMBINATION OF PRODUCTS EVEN IF DESCRIBED IN TI RESOURCES OR OTHERWISE. IN NO EVENT SHALL TI BE LIABLE FOR ANY ACTUAL, DIRECT, SPECIAL, COLLATERAL, INDIRECT, PUNITIVE, INCIDENTAL, CONSEQUENTIAL OR EXEMPLARY DAMAGES IN CONNECTION WITH OR ARISING OUT OF TI RESOURCES OR USE THEREOF, AND REGARDLESS OF WHETHER TI HAS BEEN ADVISED OF THE POSSIBILITY OF SUCH DAMAGES.

You agree to fully indemnify TI and its representatives against any damages, costs, losses, and/or liabilities arising out of your non-compliance with the terms and provisions of this Notice.

This Notice applies to TI Resources. Additional terms apply to the use and purchase of certain types of materials, TI products and services. These include; without limitation, TI's standard terms for semiconductor products (<http://www.ti.com/sc/docs/stdterms.htm>), [evaluation modules](#), and [samples](http://www.ti.com/sc/docs/sampterm.htm) (<http://www.ti.com/sc/docs/sampterm.htm>).

Mailing Address: Texas Instruments, Post Office Box 655303, Dallas, Texas 75265
Copyright © 2017, Texas Instruments Incorporated

Looking for pricing, stock, or lifecycle information?

Click below to explore more details on WIN SOURCE:

 [View TWL6032A2B4YFFT on WIN SOURCE](#)

 [Texas Instruments](#) Information

Optimize Your Supply Chain with WIN SOURCE Solutions

-  Global Sourcing Solution
-  Obsolete Management
-  Cost Control Management
-  Shortage Management
-  Alternative Solution
-  Excess Inventory Management