



**THE DATASHEET OF
TPS84621EVM-692**



Using the TPS84320EVM-692, TPS84620EVM-692 and TPS84621EVM-692

User's Guide



Literature Number: SLVU415A
August 2011

TPS84320EVM-692, TPS84620EVM-692 and TPS84621EVM-692 Integrated Power Solution Evaluation Module

This user's guide contains background information for the TPS84620/621/320 and support documentation for the TPS84320EVM-692, TPS84620EVM-692 and TPS84621EVM-692 evaluation module (TPS84x2xEVM-692).

1 Introduction

The TPS84620 integrated power solution is designed to provide up to a 6-A output. The TPS84620 contains dual-voltage inputs for the power stage and control circuitry. The power stage input (PVIN) is rated for 1.6 V to 14.5 V whereas the control input (VIN) is rated for 4.5 V to 14.5 V. The TPS84x2xEVM-692 provides both inputs but is designed and tested with PVIN connected to VIN. Rated input voltage and output current range for the evaluation module are given in [Table 1](#).

1.1 Features

- Complete Integrated Power Solution Allows Small Footprint, Low-Profile Design
- Efficiencies Up To 96%
- Wide-Output Voltage Adjust 1.2 V to 5.5 V, with 1% Reference Accuracy
- Adjustable Switching Frequency

1.2 Applications

- Broadband and Communications Infrastructure
- Automated Test and Medical Equipment
- Compact PCI/PCI Express/PXI Express
- DSP and FPGA Point-of-Load Applications

1.3 Background

This evaluation module is designed to demonstrate the small printed-circuit-board areas that may be achieved when designing with the TPS84320/620/621 regulator. The TPS84x2xEVM-692 default output voltage is 3.3 V at a 630-kHz switching frequency. The high-side and low-side MOSFETs are incorporated inside the TPS84320/620/621 package along with the gate drive circuitry. The low drain-to-source on-resistance of the MOSFET allows the TPS84320/620/621 to achieve high efficiencies and helps keep the junction temperature low at high output currents. The compensation components are internal to the TPS84320/620/621, and external resistors and jumpers allow for adjustable output voltage and frequency adjustment. Additionally, the TPS84320/620/621 provides adjustable slow start, tracking, and undervoltage lockout inputs. The absolute maximum input voltage is 15 V for the TPS84x2xEVM-692.

Table 1. Input Voltage and Output Current Summary

EVM	INPUT VOLTAGE RANGE	OUTPUT CURRENT RANGE
TPS84320EVM-692	PVIN = VIN = 8 V to 14.5 V	0 A to 6 A
TPS84620EVM-692	PVIN = VIN = 4.5 V to 14.5 V	0 A to 3 A
TPS84621EVM-692	PVIN = VIN = 8 V to 14.5 V	0 A to 6 A

2 Electrical Characteristics

A summary of the TPS84620EVM-692 performance specifications is provided in [Table 2](#). Specifications are given for an input voltage of 12 V and an output voltage of 3.3 V, unless otherwise specified. The ambient temperature is 25°C for all measurements, unless otherwise noted.

Table 2. TPS84620EVM-692 Electrical and Performance Specification

PARAMETER	CONDITION		MIN	TYP	MAX	UNITS
Output Voltage	8 V ≤ PVIN = VIN ≤ 14.5 V, ILOAD ≤ ILOAD (max)	5 V	4.925	5.00	5.075	Volts
		3.3 V	3.250	3.30	3.350	
		2.5 V	2.462	2.50	2.538	
		1.8 V	1.773	1.80	1.827	
		1.5 V	1.477	1.50	1.523	
		1.2 V	1.182	1.20	1.218	
Output Current	8 V ≤ PVIN = VIN ≤ 14.5 V		–	–	6.0	Amps
Output ripple voltage, peak-to-peak	PVIN = VIN = 12 V, ILOAD = 6 A	5 V	–	12	–	mV
		3.3 V				
		2.5 V				
		1.8 V				
		1.5 V				
		1.2 V				
Switching frequency	PVIN = VIN = 12 V, ILOAD = 6 A	5 V		780		kHz
		3.3 V		780		
		3.3 V		630		
		2.5 V		630		
		2.5 V		530		
		1.8 V		630		
		1.8 V		480		
		1.5 V		630		
		1.5 V		480		
		1.2 V		580		
	1.2 V	480				
Efficiency, end-to-end	ILOAD = 6 A PVIN = VIN = 12 V PVIN = VIN = 5 V PVIN = VIN = 12 V PVIN = VIN = 5 V PVIN = VIN = 12 V PVIN = VIN = 5 V PVIN = VIN = 12 V PVIN = VIN = 5 V PVIN = VIN = 12 V PVIN = VIN = 5 V PVIN = VIN = 12 V PVIN = VIN = 5 V PVIN = VIN = 12 V	5 V, 780 kHz		91%		
		3.3 V, 780 kHz		89%		
		3.3 V, 630 kHz		88%		
		2.5 V, 630 kHz		87%		
		2.5 V, 480 kHz		86%		
		1.8 V, 630 kHz		83%		
		1.8 V, 480 kHz		82%		
		1.5 V, 630 kHz		81%		
		1.5 V, 480 kHz		80%		
		1.2 V, 580 kHz		79%		
		1.2 V, 480 kHz		78%		
		Line Regulation				
Load Regulation				±0.1%		
Load Transient Deviation	1 A/μs load step 50% to 100% ILOAD			60		mV
Load Transient Recovery Time	1 A/μs load step 50% to 100% ILOAD			80		μs
Operating Temperature			–40		85	°C
Slow Start				4		ms
Tracking			0 to 1.2	0 to 1.8	0 to 5	V
Synchronization			480		780	kHz

3 Schematic

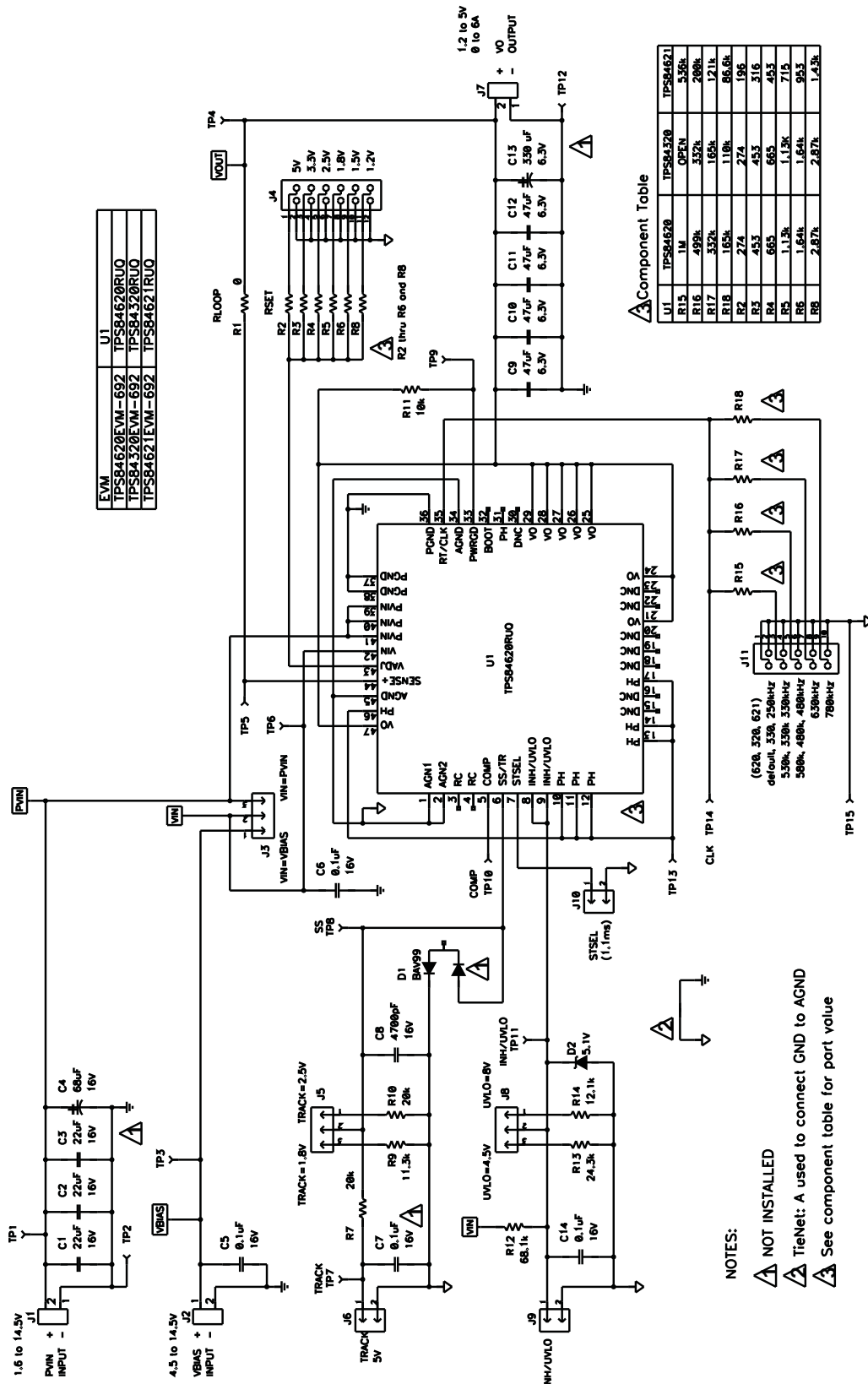

Figure 1. TPS84x2xEVM-692 Schematic

4 Modifications

These evaluation modules are designed to provide access to the features of the TPS84320/620/621. Some modifications can be made to these modules.

4.1 Output Voltage Setpoint

Select the output voltage at J4. Use the silk screen to select the desired voltage preprogrammed on the module (see [Figure 13](#). If a different voltage is needed, the RSET resistor (any of R2 thru R6 and R8) may be changed to a value listed in the component data sheet ([TPS84620](#), [TPS84621](#) and [TPS84320](#)).

When all jumpers on J4 are open, the default output voltage for the components is selected. See [Table 3](#).

Table 3. Component Default Output Voltage

COMPONENT	DEFAULT VOLTAGE
TPS84620	NA, No Default Voltage
TPS84320	0.8 V
TPS84621	0.6 V

4.2 Frequency Select

The Switching frequency is selected at J11. [Table 4](#) shows the selection options for each of the three evaluation modules.

Table 4. Selection Options

JUMPER POSITION	TPS84620EVM-692	TPS84320EVM-692	TPS84621EVM-692
MIN	480 kHz	330 kHz	250 kHz
1	530 kHz	330 kHz	330 kHz
2	580 kHz	480 kHz	480 kHz
3	630 kHz	630 kHz	630 kHz
MAX	780 kHz	780 kHz	780 kHz

4.3 Slow Start Time

The slow start time can be adjusted by changing the value of C8. See the slow start table in the ([TPS84620](#), TPS84621 and TPS84320 data sheets for more information. The EVM is set for a slow start time of 2.8 ms (C8 = 4700 pF and J10 installed).

4.4 Track In

The TPS84320/620/621 can track an external voltage during start-up. The J6 connector is provided to allow connection to an external voltage. Ratio-metric or simultaneous tracking can be implemented using the provided resistor dividers with J5. See the ([TPS84620](#), TPS84621 and TPS84320 data sheets for details.

4.5 Adjustable UVLO

The undervoltage lockout (UVLO) can be adjusted as described in the ([TPS84620](#), TPS84621 and TPS84320 data sheets. The EVM provides two selectable UVLO setpoints using the provided resistor dividers and J8. J9 provides an inhibit input.

4.6 Input Voltage Rails

The EVM is designed to accommodate different input voltage levels for the power stage and control logic. During normal operation, the PVIN and VIN inputs are connected using a jumper across J3 pins 2 and 3 (VIN = PVIN position). The single input voltage is supplied at J1. If desired, input voltage may be separated by moving the J3 jumper to pins 1 and 2 (VIN = VBIAS position). Dual input voltages must then be provided at both J1 and J2.

5 Test Setup

This section describes how to properly connect, set up, and use the TPS84x2xEVM-692 evaluation module.

5.1 Input/Output Connections

The TPS84x2xEVM-692 is provided with input/output connectors and test points as shown in [Table 5](#). A power supply capable of supplying 4 A must be connected to J1 through a pair of 20 AWG wires. The jumper across J3 must be in place. See [Section 4.6](#) for split input voltage rail operation. The load must be connected to J7 through a pair of 20 AWG wires. The maximum load current capability must be 6 A. Wire lengths must be minimized to reduce losses in the wires. Test-point TP1 provides a place to monitor the V_{IN} input voltages with TP2 providing a convenient ground reference. TP4 is used to monitor the output voltage with TP12 as the ground reference.

Table 5. EVM Connectors and Test Points

REF DES	LABEL	DESCRIPTION
J1	PVIN	Primary VIN connector
J2	VBIAS	VBIAS input voltage input connector
J3	VIN	Jumper used to connect VIN to PVIN. EVM default setting connects VIN to PVIN.
J7	VOUT	VOUT connector
J4	VADJ	VOUT selection. Default VOUT is 3.3 V.
J11	FREQ	Switching frequency selection. Default frequency is 630 kHz.
J6	TR_IN	TRACK IN connector. J5 provides two divider settings.
J5	SS_TR	Track voltage select jumper. Used with J6.
J9	INH_UVLO	Enable jumper. Install shunt to inhibit the power supply.
J8	INH_UVLO	Selects UVLO for power supply turn on. Default setting is for 8-V UVLO.
J10	STSEL	Internal slow start select jumper. Install shunt for internal slow start.
TP1	PVIN	PVIN circuit point
TP3	VBIAS	VBIAS circuit point
TP6	VIN	VIN circuit point
TP4	VOUT	VOUT circuit point
TP2, TP12	GND	Power grounds
TP15	AGND	Analog ground
TP7	TR_IN	Track input
TP8	SS_TR	Tracking input after divider
TP9	PWRGD	Power good status
TP14	RT/CLK	SYNC input
TP10	COMP	Error amplifier output
TP13	PH	Switch node
TP11	INH_UVLO	Inhibit and UVLO input
TP5	SENSE+	VOUT remote sense node connected to J7 pin 2. TP5 can be used for measuring the loop response along with changing R1 to 49.9 Ω .

6 Typical Performance Data

Figure 2 through Figure 12 present characteristic performance data taken from the TPS84620EVM-692 only. For data regarding the TPS84320EVM-692 and the TPS84621EVM-692 please see the TPS84320 and TPS84621 data sheet.

6.1 Efficiency vs Input Voltage

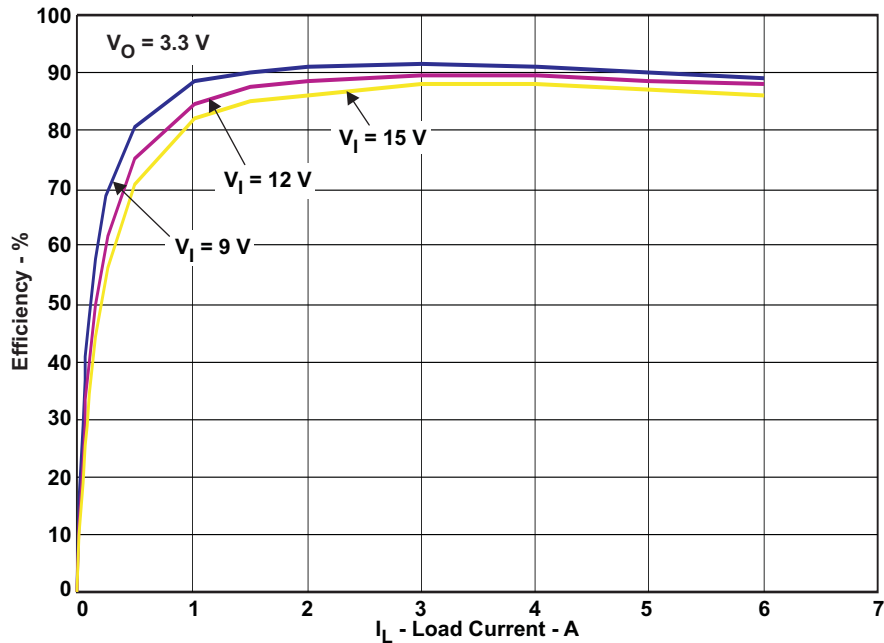

Figure 2. Efficiency vs Voltage at 25°C

6.2 Light-Load Efficiency vs Input Voltage

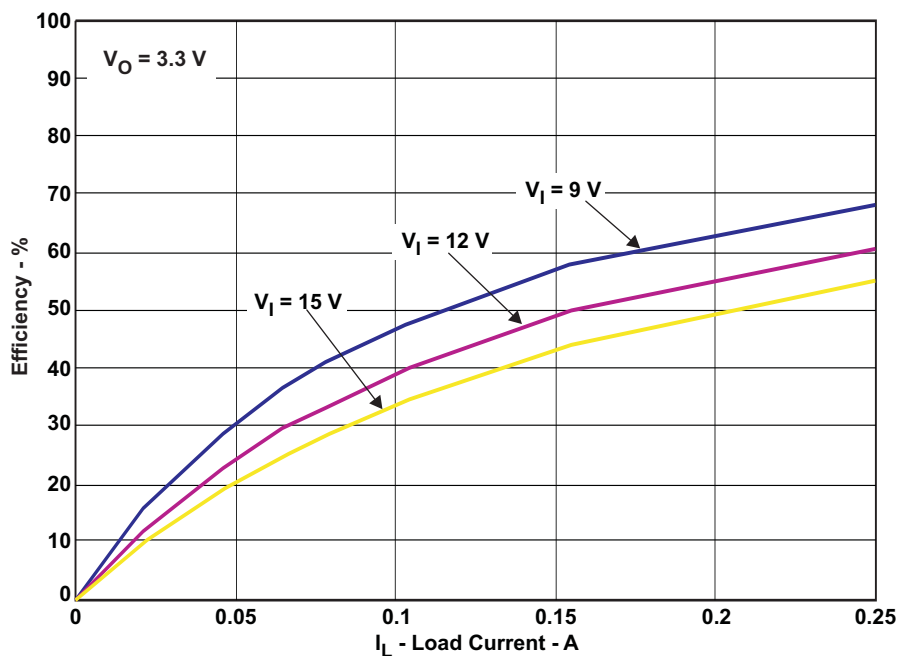

Figure 3. Light-Load Efficiency vs Input Voltage at 25°C

6.3 Efficiency vs Output Voltage/Frequency, $P_{VIN} = 12\text{ V}$

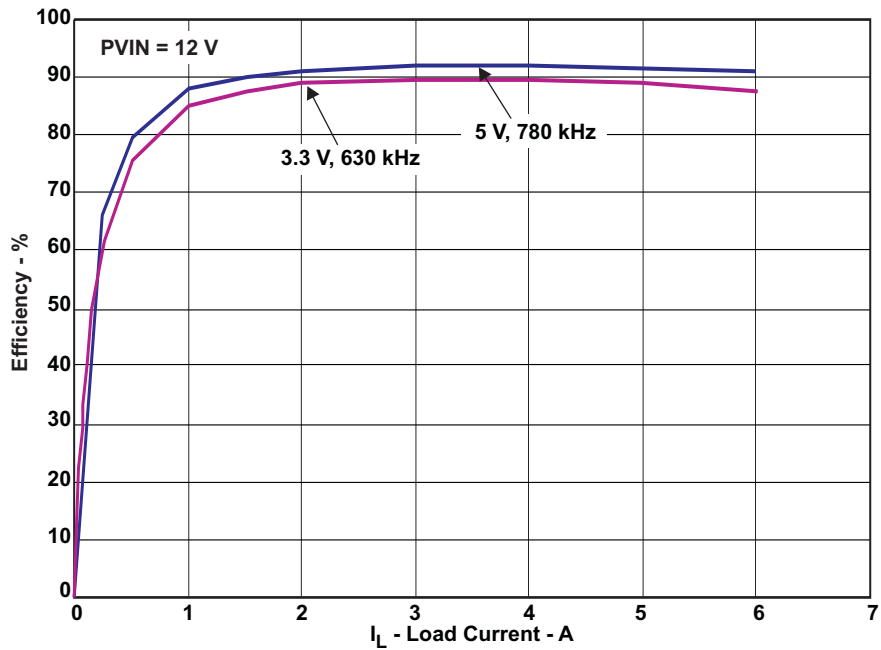

Figure 4. Efficiency vs Output Voltage at 25°C

6.4 Efficiency vs Output Voltage/Frequency, $P_{VIN} = 5\text{ V}$

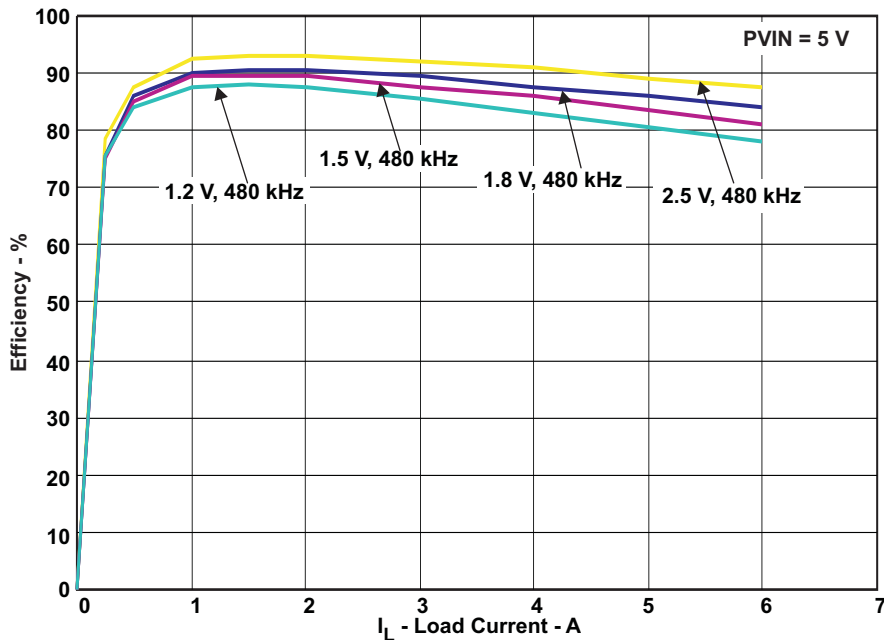

Figure 5. Efficiency vs Output Voltage/Frequency at 25°C

6.5 Output Voltage Load Regulation

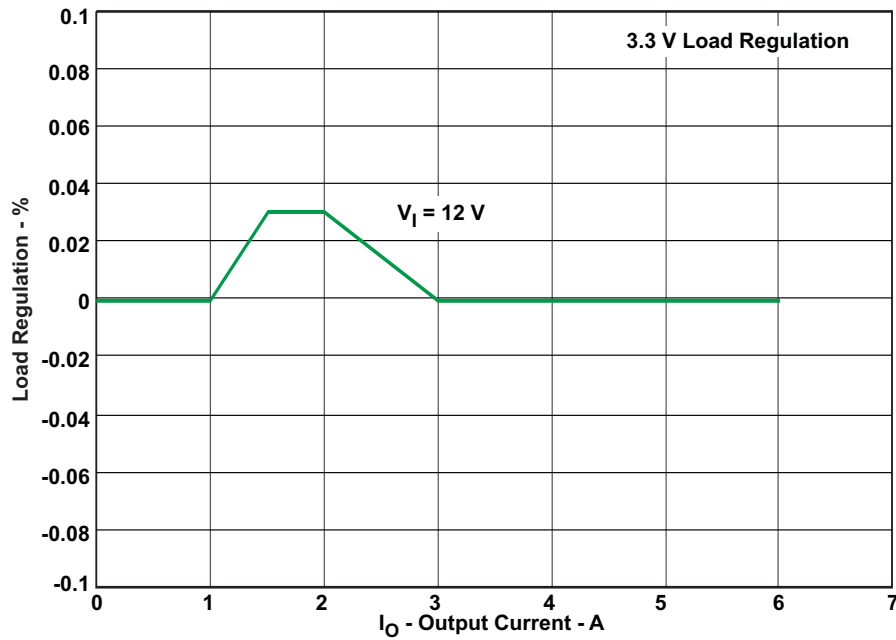

Figure 6. Load Regulation at 25°C

6.6 Output Voltage Line Regulation

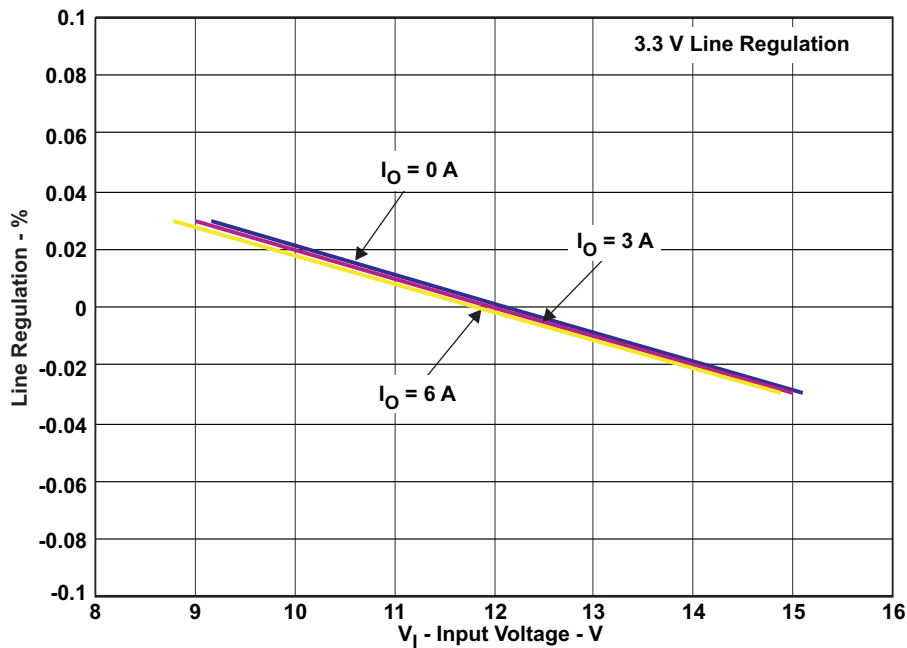

Figure 7. Line Regulation at 25°C

6.7 3.3-V TPS84620EVM-692 Response to Load Transients

Figure 8 shows the TPS84620EVM-692 response to load transients. The current step is from 1.5 A to 4.5 A at 12-V input. Total peak-to-peak voltage variation is as shown, including ripple and noise on the output.

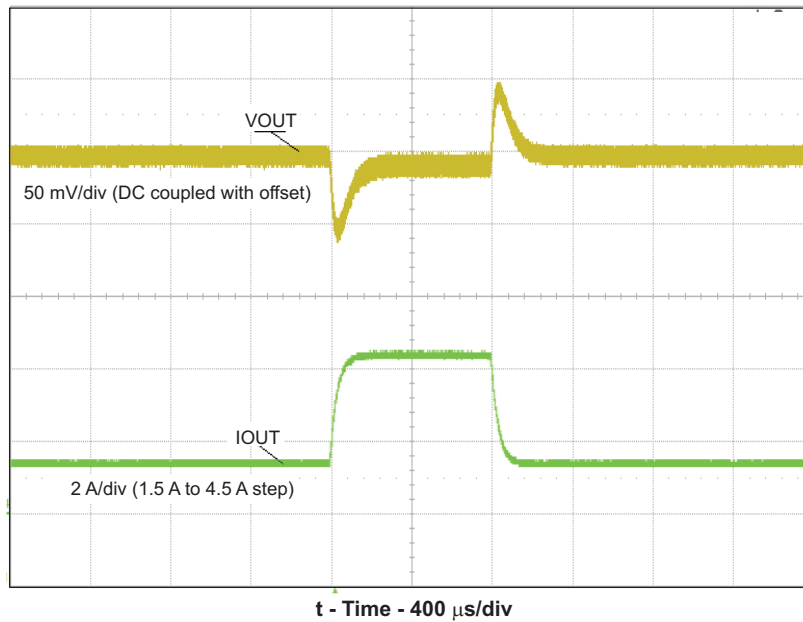

Figure 8. 3.3-V TPS84620EVM-692 Transient Response at 25°C

6.8 TPS84620EVM-692 Loop Response

Figure 9 shows the TPS84620EVM-692 loop response. The unity gain bandwidth is 50 kHz, phase margin is 70 degrees, gain margin is 19 dB and the gain slope is -1 .

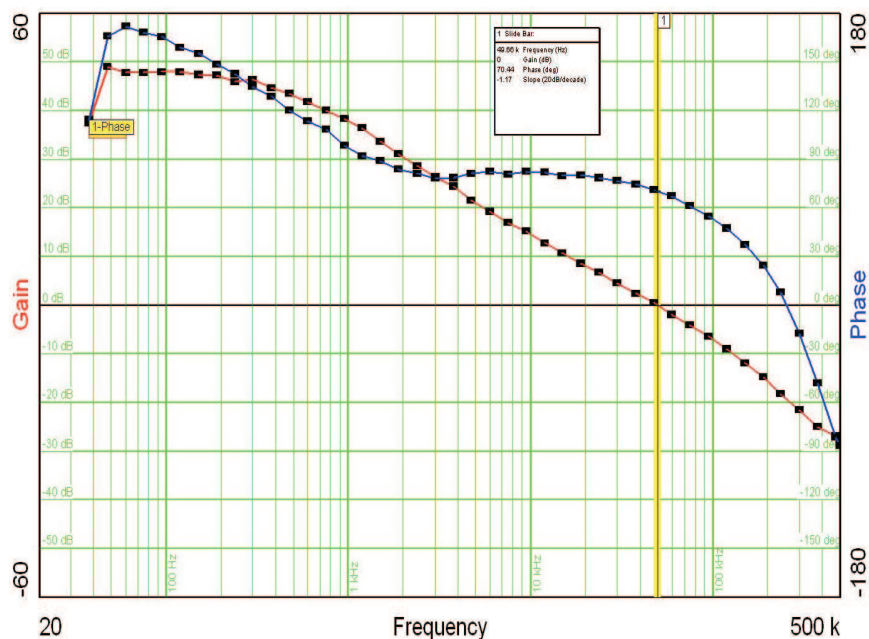

Figure 9. TPS84620EVM-692 Loop Response at 25°C

6.9 TPS84620EVM-692 Voltage Ripple

Figure 10 shows the TPS84620EVM-692 output voltage ripple when operating from 12 V with an output load of 6 A.

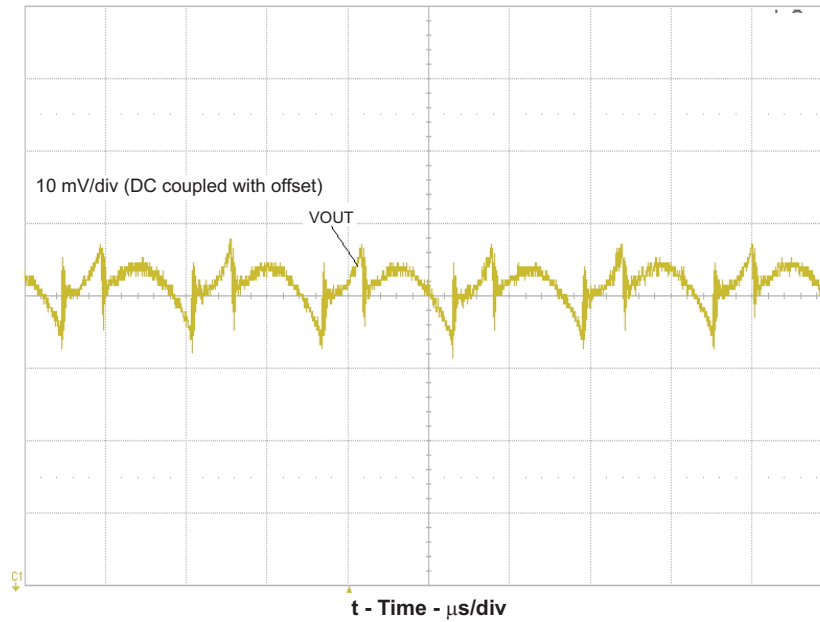

Figure 10. TPS84620EVM-692 Output Voltage Ripple

Figure 11 shows the TPS84620EVM-692 input voltage ripple when operating from 12 V with an output load of 6 A.

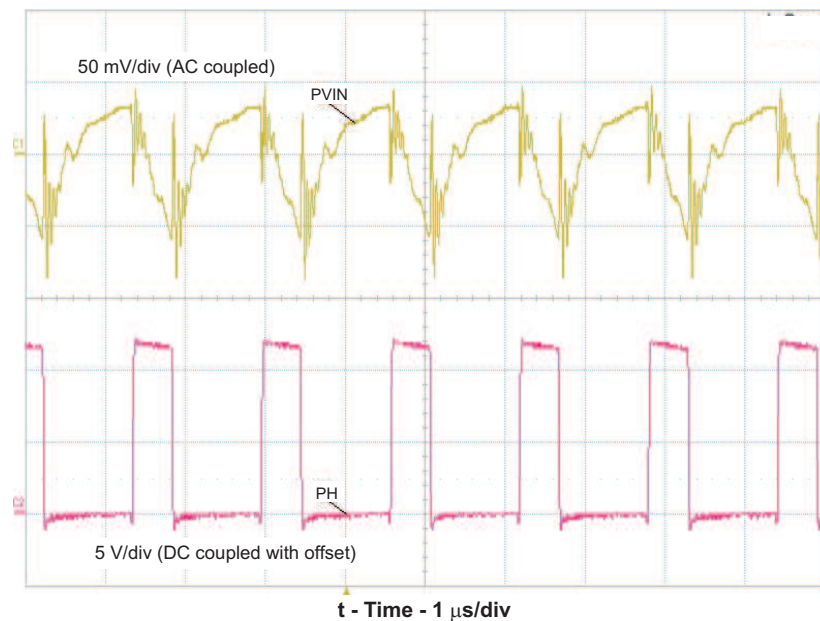

Figure 11. TPS84620EVM-692 Input Voltage Ripple

6.10 Power Up

Figure 12 shows the TPS84620EVM-692 start-up waveforms with rising PVIN. In Figure 12, the output starts to rise when PVIN reaches the rising UVLO of 8 V. J9 can also be used to inhibit VOUT when PVIN is present.

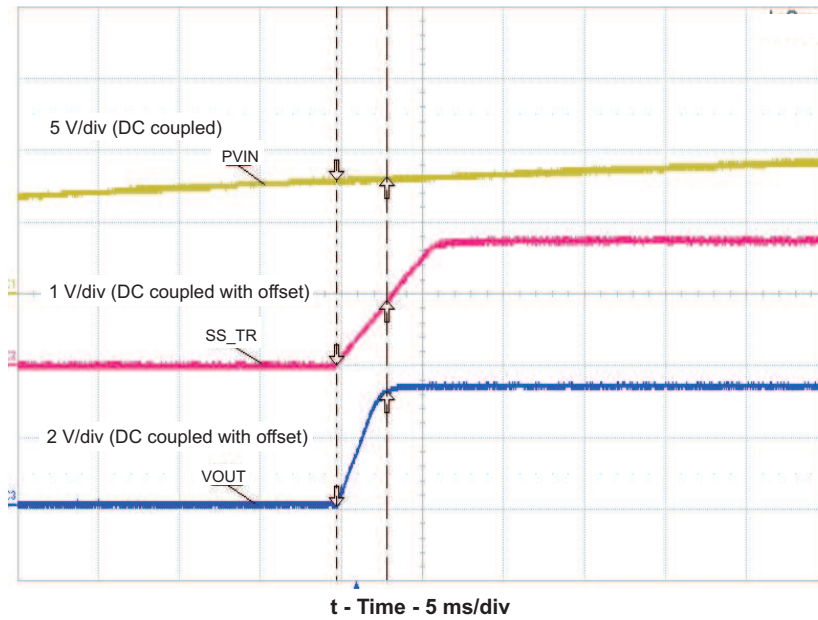

Figure 12. TPS84620EVM-692 Start-Up Waveforms With Rising PVIN

7 Board Layout/Assembly Drawing

This section provides a description of the TPS84x2xEVM-692, board layout, and layer illustrations.

7.1 Layout

The board layout for the TPS84x2xEVM-692 is shown in [Figure 14](#) through [Figure 13](#). The topside layer of the EVM is laid out in a manner typical of a user application. The top, bottom, and internal layers are 2-oz. copper. A basic set of layout guidelines include:

- Place the input capacitors close to the PVIN and PGND terminals.
- Place the output capacitors close to the VO and PGND terminals.
- AGND is a 0-Vdc reference for the analog control circuitry. Connect AGND to PGND at a single point. AGND terminal 45 provides a means to remove heat from the device and must be connected to an AGND plane with multiple vias as shown in the TPS84620 data sheet, ([SLVSA43](#)).
- The SENSE+ pin (pin 44) provides a remote sense function for the device. Connect the SENSE+ pin to VO near the load.
- Analog control pins: Connect the analog control pins (VADJ, RT/CLK, INH/UVLO, STSEL, and SS/TR) to AGND using the recommended circuit components.

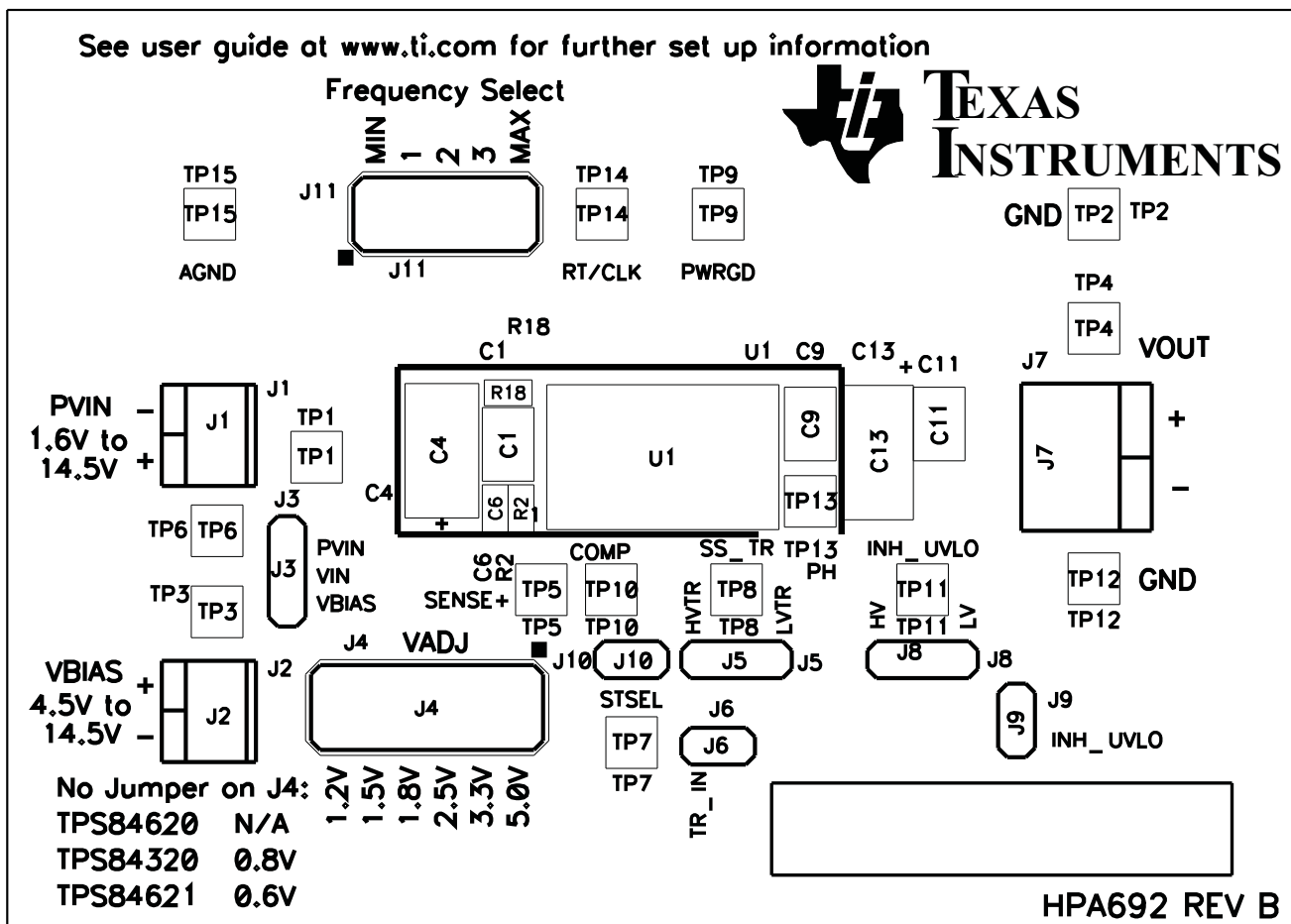

Figure 13. TPS84x2xEVM-692 Top-Side Layer and Assembly

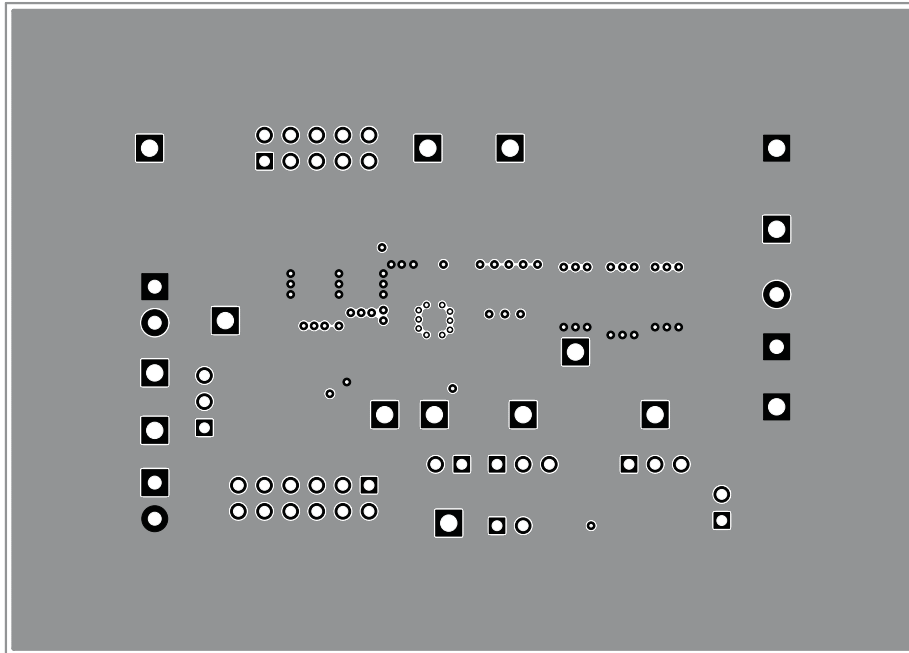

Figure 14. TPS84x2xEVM-692 Layer 2

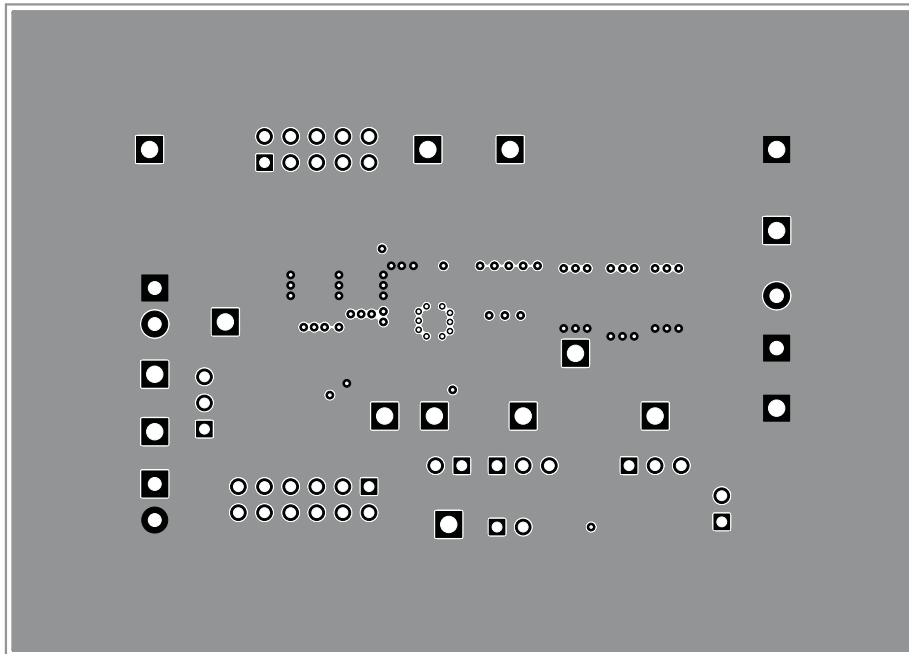

Figure 15. TPS84x2xEVM-692 Layer 3

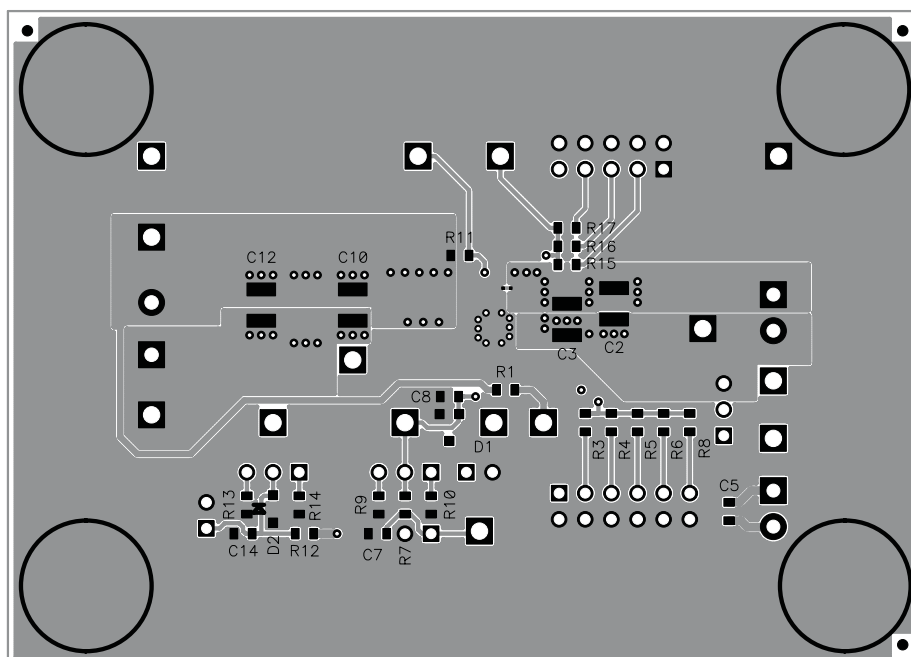

Figure 16. TPS84x2xEVM-692 Bottom-Side Layer and Assembly

7.2 Estimated Circuit Area

The estimated printed-circuit board area for the components used in this design is 0.55 in² (354 mm²). This area does not include test point or connectors.

8 List of Materials

Table 6 presents the List of Materials for the TPS84320EVM-692, TPS84620EVM-692 and TPS84621EVM-692.

Table 6. TPS84x2xEVM-692 List of Materials ⁽¹⁾⁽²⁾⁽³⁾⁽⁴⁾⁽⁵⁾⁽⁶⁾

-003	-002	-001	REF DES	DESCRIPTION	PART NUMBER	MFR
2	2	2	C1, C2	Capacitor, ceramic, 16 V, X5R, 10%, 22 μ F, 1210	GRM32ER61E226K	Murata
0	0	0	C3	Capacitor, ceramic, 16 V, X5R, 10%, 22 μ F, 1210	GRM32ER61E226K	Murata
0	0	0	C13	Capacitor, polymer SMT, 6.3 V, -25 to 105°C, \pm 20%, 330 μ F, 7343(D)	T530D337M006ATE006	Kemet
1	1	1	C4	Capacitor, polymer tantalum, 16 V, 20%, 68 μ F, 7343(D)	16TQC68M	Sanyo
3	3	3	C5, C6, C14	Capacitor, ceramic, 16 V, X7R, 10%, 0.1 μ F, 0603	Std	Std
0	0	0	C7	Capacitor, ceramic, 16 V, X7R, 10%, 0.1 μ F, 0603	Std	Std
1	1	1	C8	Capacitor, ceramic, 16 V, X7R, 10%, 4700 pF, 0603	Std	Std
4	4	4	C9, C10, C11, C12	Capacitor, ceramic, 6.3 V, X5R, 10%, 47 μ F, 1210	GRM32ER60J476M	Murata
0	0	0	D1	Diode, dual ultra fast, series, 200 mA, 70 V, BAV99, SOT23	BAV99	Fairchild
1	1	1	D2	Diode, Zener, 200 mW, 5.1 V, SOD-323	BZT52C5V1S	Diodes Inc.
2	2	2	J1, J2	Terminal block, 2 pin, 6 A, 3.5 mm, 0.27 inch x 0.25 inch	ED555/2DS	OST
1	1	1	J11	Header, male 2x5 pin, 100-mil spacing, 0.100 inch x 5 inch x 2 inch	PEC05DAAN	Sullins
3	3	3	J3, J5, J8	Header, male 3 pin, 100-mil spacing, 0.100 inch x 3 inch	PEC03SAAN	Sullins
1	1	1	J4	Header, male 2x6 pin, 100-mil spacing, 0.100 inch x 2 inch x 6 inch	PEC06DAAN	Sullins
3	3	3	J6, J9, J10	Header, male 2-pin, 100mil spacing, 0.100 inch x 2 inch	PEC02SAAN	Sullins
1	1	1	J7	Terminal block, 2 pin, 15 A, 5.1 mm, 0.40 inch x 0.35 inch	ED120/2DS	OST
1	1	1	R1	Resistor, chip, 1/10 W, -100/+600 ppm/°C, 0 Ω , 0603	Std	Std

⁽¹⁾ These assemblies are ESD sensitive, ESD precautions shall be observed.

⁽²⁾ These assemblies must be clean and free from flux and all contaminants. Use of no clean flux is not acceptable.

⁽³⁾ These assemblies must comply with workmanship standards IPC-A-610 Class 2.

⁽⁴⁾ Ref designators marked with an asterisk (***) cannot be substituted. All other components can be substituted with equivalent MFG's components.

⁽⁵⁾ Install shunts in the following positions (Table 7):

⁽⁶⁾ Install label after final wash. Text shall be 8 pt font. Text shall be per Table 8.

Table 6. TPS84x2xEVM-692 List of Materials⁽¹⁾⁽²⁾⁽³⁾⁽⁴⁾⁽⁵⁾⁽⁶⁾ (continued)

-003	-002	-001	REF DES	DESCRIPTION	PART NUMBER	MFR
1	1	1	R11	Resistor, chip, 1/16 W, 1%, 10 kΩ, 0603	Std	Std
1	1	1	R12	Resistor, chip, 1/16 W, 1%, 68.1 kΩ, 0603	Std	Std
1	1	1	R13	Resistor, chip, 1/16 W, 1%, 24.3 kΩ, 0603	Std	Std
1	1	1	R14	Resistor, chip, 1/16 W, 1%, 12.1 kΩ, 0603	Std	Std
0	0	1	R15	Resistor, chip, 1/16 W, 1%, 1 MΩ, 0603	Std	Std
1	0	0	R15	Resistor, chip, 1/16 W, 1%, 536 kΩ, 0603	Std	Std
0	0	1	R16	Resistor, chip, 1/16 W, 1%, 499 kΩ, 0603	Std	Std
0	1	0	R16	Resistor, chip, 1/16 W, 1%, 332 kΩ, 0603	Std	Std
1	0	0	R16	Resistor, chip, 1/16 W, 1%, 200 kΩ, 0603	Std	Std
0	0	1	R17	Resistor, chip, 1/16 W, 1%, 332 kΩ, 0603	Std	Std
0	1	0	R17	Resistor, chip, 1/16 W, 1%, 165 kΩ, 0603	Std	Std
1	0	0	R17	Resistor, chip, 1/16 W, 1%, 121 kΩ, 0603	Std	Std
0	0	1	R18	Resistor, chip, 1/16 W, 1%, 165 kΩ, 0603	Std	Std
0	1	0	R18	Resistor, chip, 1/16 W, 1%, 110 kΩ, 0603	Std	Std
1	0	0	R18	Resistor, chip, 1/16 W, 1%, 86.6 kΩ, 0603	Std	Std
0	1	1	R2	Resistor, chip, 1/16 W, 1%, 274 Ω, 0603	Std	Std
1	0	0	R2	Resistor, chip, 1/16 W, 1%, 196 Ω, 0603	Std	Std
0	1	1	R3	Resistor, chip, 1/16 W, 1%, 453 Ω, 0603	Std	Std
1	0	0	R3	Resistor, chip, 1/16 W, 1%, 316 Ω, 0603	Std	Std
0	1	1	R4	Resistor, chip, 1/16 W, 1%, 665 Ω, 0603	Std	Std
1	0	0	R4	Resistor, chip, 1/16 W, 1%, 453 Ω, 0603	Std	Std
0	1	1	R5	Resistor, chip, 1/16 W, 1%, 1.13 kΩ, 0603	Std	Std
1	0	0	R5	Resistor, chip, 1/16 W, 1%, 715 Ω, 0603	Std	Std
0	1	1	R6	Resistor, chip, 1/16 W, 1%, 1.64 kΩ, 0603	Std	Std
1	0	0	R6	Resistor, chip, 1/16 W, 1%, 953 Ω, 0603	Std	Std
0	1	1	R8	Resistor, chip, 1/16 W, 1%, 2.87 kΩ, 0603	Std	Std
1	0	0	R8	Resistor, chip, 1/16 W, 1%, 1.43 kΩ, 0603	Std	Std
2	2	2	R7, R10	Resistor, chip, 1/16 W, 1%, 20 kΩ, 0603	Std	Std
0	0	0	R6	Resistor, chip, 1/16 W, 1%, 0603	Std	Std
1	1	1	R9	Resistor, chip, 1/16 W, 1%, 11.3 kΩ, 0603	Std	Std

Table 6. TPS84x2xEVM-692 List of Materials⁽¹⁾⁽²⁾⁽³⁾⁽⁴⁾⁽⁵⁾⁽⁶⁾ (continued)

-003	-002	-001	REF DES	DESCRIPTION	PART NUMBER	MFR
4	4	4	TP1, TP3, TP4, TP6	Test point, red, thru hole, 5010, 0.125 inch x 0.125 inch	5010	Keystone
3	3	3	TP2, TP12, TP15	Test point, black, thru hole, 5011, 0.125 inch x 0.125 inch	5011	Keystone
3	3	3	TP5, TP10, TP13	Test point, orange, thru hole, 5013, 0.125 inch x 0.125 inch	5013	Keystone
5	5	5	TP7, TP8, TP9, TP11, TP14	Test point, white, thru hole, 5012, 0.125 inch x 0.125 inch	5012	Keystone
0	0	1	U1	5-V Input, 6-A Sync. Buck, SWIFT Module, QFN	TPS84620RUQ	TI
0	1	0	U1	5-V Input, 3-A Sync. Buck, SWIFT Module, QFN	TPS84320RUQ	TI
1	0	0	U1	5-V Input, 6-A Sync. Buck, SWIFT Module, QFN	TPS84621RUQ	TI
4	4	4		Bumpon hemisphere 0.44 x 0.20 black	SJ-5003	3M
5	5	5		Shunt, black, 100 mil	929950-00	3M
1	1	1	--	PCB, 3.5 inch x 2.5 inch x 0.062 inch	HPA692	Any

Table 7.

REF DES	PIN NUMBER
J3	2-3
J4	3-4
J8, J10	1-2
J11	7-8

Table 8.

ASSEMBLY NUMBER	TEXT
HPA692-001	TPS84620EVM-692
HPA692-002	TPS84320EVM-692
HPA692-003	TPS84621EVM-692

Evaluation Board/Kit Important Notice

Texas Instruments (TI) provides the enclosed product(s) under the following conditions:

This evaluation board/kit is intended for use for **ENGINEERING DEVELOPMENT, DEMONSTRATION, OR EVALUATION PURPOSES ONLY** and is not considered by TI to be a finished end-product fit for general consumer use. Persons handling the product(s) must have electronics training and observe good engineering practice standards. As such, the goods being provided are not intended to be complete in terms of required design-, marketing-, and/or manufacturing-related protective considerations, including product safety and environmental measures typically found in end products that incorporate such semiconductor components or circuit boards. This evaluation board/kit does not fall within the scope of the European Union directives regarding electromagnetic compatibility, restricted substances (RoHS), recycling (WEEE), FCC, CE or UL, and therefore may not meet the technical requirements of these directives or other related directives.

Should this evaluation board/kit not meet the specifications indicated in the User's Guide, the board/kit may be returned within 30 days from the date of delivery for a full refund. **THE FOREGOING WARRANTY IS THE EXCLUSIVE WARRANTY MADE BY SELLER TO BUYER AND IS IN LIEU OF ALL OTHER WARRANTIES, EXPRESSED, IMPLIED, OR STATUTORY, INCLUDING ANY WARRANTY OF MERCHANTABILITY OR FITNESS FOR ANY PARTICULAR PURPOSE.**

The user assumes all responsibility and liability for proper and safe handling of the goods. Further, the user indemnifies TI from all claims arising from the handling or use of the goods. Due to the open construction of the product, it is the user's responsibility to take any and all appropriate precautions with regard to electrostatic discharge.

EXCEPT TO THE EXTENT OF THE INDEMNITY SET FORTH ABOVE, NEITHER PARTY SHALL BE LIABLE TO THE OTHER FOR ANY INDIRECT, SPECIAL, INCIDENTAL, OR CONSEQUENTIAL DAMAGES.

TI currently deals with a variety of customers for products, and therefore our arrangement with the user **is not exclusive.**

TI assumes **no liability for applications assistance, customer product design, software performance, or infringement of patents or services described herein.**

Please read the User's Guide and, specifically, the Warnings and Restrictions notice in the User's Guide prior to handling the product. This notice contains important safety information about temperatures and voltages. For additional information on TI's environmental and/or safety programs, please contact the TI application engineer or visit www.ti.com/esh.

No license is granted under any patent right or other intellectual property right of TI covering or relating to any machine, process, or combination in which such TI products or services might be or are used.

FCC Warning

This evaluation board/kit is intended for use for **ENGINEERING DEVELOPMENT, DEMONSTRATION, OR EVALUATION PURPOSES ONLY** and is not considered by TI to be a finished end-product fit for general consumer use. It generates, uses, and can radiate radio frequency energy and has not been tested for compliance with the limits of computing devices pursuant to part 15 of FCC rules, which are designed to provide reasonable protection against radio frequency interference. Operation of this equipment in other environments may cause interference with radio communications, in which case the user at his own expense will be required to take whatever measures may be required to correct this interference.

EVM Warnings and Restrictions

It is important to operate this EVM within the input voltage range of 4.5 V to 14.5 V and the output voltage range of 1.2 V to 5 V .

Exceeding the specified input range may cause unexpected operation and/or irreversible damage to the EVM. If there are questions concerning the input range, please contact a TI field representative prior to connecting the input power.

Applying loads outside of the specified output range may result in unintended operation and/or possible permanent damage to the EVM. Please consult the EVM User's Guide prior to connecting any load to the EVM output. If there is uncertainty as to the load specification, please contact a TI field representative.

During normal operation, some circuit components may have case temperatures greater than 55°C. The EVM is designed to operate properly with certain components above 60°C as long as the input and output ranges are maintained. These components include but are not limited to linear regulators, switching transistors, pass transistors, and current sense resistors. These types of devices can be identified using the EVM schematic located in the EVM User's Guide. When placing measurement probes near these devices during operation, please be aware that these devices may be very warm to the touch.

Mailing Address: Texas Instruments, Post Office Box 655303, Dallas, Texas 75265
Copyright © 2011, Texas Instruments Incorporated

IMPORTANT NOTICE

Texas Instruments Incorporated and its subsidiaries (TI) reserve the right to make corrections, modifications, enhancements, improvements, and other changes to its products and services at any time and to discontinue any product or service without notice. Customers should obtain the latest relevant information before placing orders and should verify that such information is current and complete. All products are sold subject to TI's terms and conditions of sale supplied at the time of order acknowledgment.

TI warrants performance of its hardware products to the specifications applicable at the time of sale in accordance with TI's standard warranty. Testing and other quality control techniques are used to the extent TI deems necessary to support this warranty. Except where mandated by government requirements, testing of all parameters of each product is not necessarily performed.

TI assumes no liability for applications assistance or customer product design. Customers are responsible for their products and applications using TI components. To minimize the risks associated with customer products and applications, customers should provide adequate design and operating safeguards.

TI does not warrant or represent that any license, either express or implied, is granted under any TI patent right, copyright, mask work right, or other TI intellectual property right relating to any combination, machine, or process in which TI products or services are used. Information published by TI regarding third-party products or services does not constitute a license from TI to use such products or services or a warranty or endorsement thereof. Use of such information may require a license from a third party under the patents or other intellectual property of the third party, or a license from TI under the patents or other intellectual property of TI.

Reproduction of TI information in TI data books or data sheets is permissible only if reproduction is without alteration and is accompanied by all associated warranties, conditions, limitations, and notices. Reproduction of this information with alteration is an unfair and deceptive business practice. TI is not responsible or liable for such altered documentation. Information of third parties may be subject to additional restrictions.

Resale of TI products or services with statements different from or beyond the parameters stated by TI for that product or service voids all express and any implied warranties for the associated TI product or service and is an unfair and deceptive business practice. TI is not responsible or liable for any such statements.

TI products are not authorized for use in safety-critical applications (such as life support) where a failure of the TI product would reasonably be expected to cause severe personal injury or death, unless officers of the parties have executed an agreement specifically governing such use. Buyers represent that they have all necessary expertise in the safety and regulatory ramifications of their applications, and acknowledge and agree that they are solely responsible for all legal, regulatory and safety-related requirements concerning their products and any use of TI products in such safety-critical applications, notwithstanding any applications-related information or support that may be provided by TI. Further, Buyers must fully indemnify TI and its representatives against any damages arising out of the use of TI products in such safety-critical applications.

TI products are neither designed nor intended for use in military/aerospace applications or environments unless the TI products are specifically designated by TI as military-grade or "enhanced plastic." Only products designated by TI as military-grade meet military specifications. Buyers acknowledge and agree that any such use of TI products which TI has not designated as military-grade is solely at the Buyer's risk, and that they are solely responsible for compliance with all legal and regulatory requirements in connection with such use.

TI products are neither designed nor intended for use in automotive applications or environments unless the specific TI products are designated by TI as compliant with ISO/TS 16949 requirements. Buyers acknowledge and agree that, if they use any non-designated products in automotive applications, TI will not be responsible for any failure to meet such requirements.

Following are URLs where you can obtain information on other Texas Instruments products and application solutions:

Products

Audio	www.ti.com/audio
Amplifiers	amplifier.ti.com
Data Converters	dataconverter.ti.com
DLP® Products	www.dlp.com
DSP	dsp.ti.com
Clocks and Timers	www.ti.com/clocks
Interface	interface.ti.com
Logic	logic.ti.com
Power Mgmt	power.ti.com
Microcontrollers	microcontroller.ti.com
RFID	www.ti-rfid.com
OMAP Mobile Processors	www.ti.com/omap
Wireless Connectivity	www.ti.com/wirelessconnectivity

Applications

Communications and Telecom	www.ti.com/communications
Computers and Peripherals	www.ti.com/computers
Consumer Electronics	www.ti.com/consumer-apps
Energy and Lighting	www.ti.com/energy
Industrial	www.ti.com/industrial
Medical	www.ti.com/medical
Security	www.ti.com/security
Space, Avionics and Defense	www.ti.com/space-avionics-defense
Transportation and Automotive	www.ti.com/automotive
Video and Imaging	www.ti.com/video

TI E2E Community Home Page

e2e.ti.com

Mailing Address: Texas Instruments, Post Office Box 655303, Dallas, Texas 75265
Copyright © 2011, Texas Instruments Incorporated

Looking for pricing, stock, or lifecycle information?

Click below to explore more details on WIN SOURCE:

 [View TPS84621EVM-692 on WIN SOURCE](#)

 [Texas Instruments](#) Information

Optimize Your Supply Chain with WIN SOURCE Solutions

-  Global Sourcing Solution
-  Obsolete Management
-  Cost Control Management
-  Shortage Management
-  Alternative Solution
-  Excess Inventory Management