



**THE DATASHEET OF
TPS2848PWP**



SYNCHRONOUS-BUCK MOSFET DRIVERS WITH DRIVE REGULATOR

FEATURES

- Integrated Drive Regulator (4 V to 14 V)
- Adjustable/Adaptive Dead-Time Control
- 4-A Peak current at VDRV of 14 V
- 10-V to 15-V Supply Voltage Range
- TTL-Compatible Inputs
- Internal Schottky Diode Reduces Part Count
- Synchronous or Nonsynchronous Operation

- Inverting and Noninverting Options
- TSSOP PowerPad™ Package for Excellent Thermal Performance

APPLICATIONS

- Single or Multiphase Synchronous-Buck Power Supplies
- High-Current DC/DC Power Modules

DESCRIPTION

The TPS2838/39/48/49 devices are MOSFET drivers designed for high-performance synchronous power supplies. The drivers can source and sink up to 4-A peak current at a 14-V drive voltage. These are ideal devices to use with power supply controllers that do not have on-chip drivers. The low-side driver is capable of driving loads of 3.3 nF in 10-ns rise/fall times and has 40-ns propagation delays at room temperature.

The MOSFET drivers have an integrated 150-mA regulator, so the gate drive voltage can be optimized for specific MOSFETs. The TPS2848 and TPS2849 have a fixed 8-V drive regulator, while the TPS2838/39 allow the drive regulator to be adjusted from 4 V to 14 V by selection of two external resistors.

The devices feature VDRV to PGND shoot-through protection with adaptive/adjustable deadtime control. The deadtime, for turning on the high-side FET from LOWDR transitioning low, is adjustable with an external capacitor on the DELAY pin. This allows compensation for the effect the gate resistor has on the synchronous FET turn off. The adaptive deadtime prevents the turning on of the low-side FET until the voltage on the BOOTLO pin falls below a threshold after the high-side FET stops conducting. The high-side drive can be configured as a ground referenced driver or a floating bootstrap driver. The internal Schottky diode minimizes the size and number of external components needed for the bootstrap driver circuit. Only one external ceramic capacitor is required to configure the bootstrap driver.

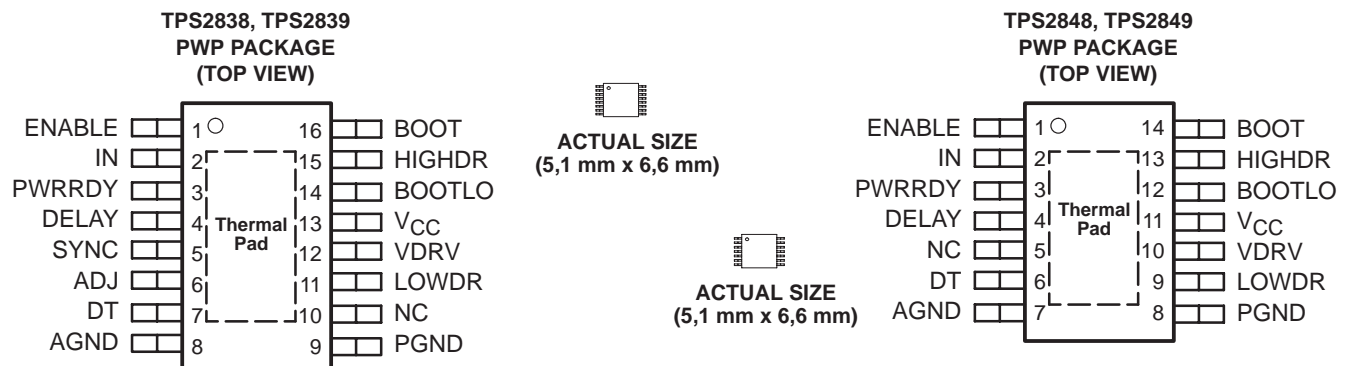

Please be aware that an important notice concerning availability, standard warranty, and use in critical applications of Texas Instruments semiconductor products and disclaimers thereto appears at the end of this data sheet.

PowerPAD is a trademark of Texas Instruments.

PRODUCTION DATA information is current as of publication date. Products conform to specifications per the terms of Texas Instruments standard warranty. Production processing does not necessarily include testing of all parameters.

description (continued)

The SYNC pin can be used regardless of load to disable the synchronous FET driver and operate the power supply nonsynchronously.

A power ready/undervoltage lockout function outputs the status of the V_{CC} -pin voltage and driver regulator output on the open-drain PWRRDY pin. This feature can be used to enable a controller's output once the V_{CC} voltage reaches the threshold and the regulator output is stable. This function ensures both FET drivers are off when the V_{CC} voltage is below the voltage threshold.

The TPS2838/39/48/49 devices are offered in the thermally enhanced 14-pin and 16-pin PowerPAD TSSOP package. The PowerPAD package features an exposed leadframe on the bottom that can be soldered to the printed-circuit board to improve thermal efficiency. The TPS2838/48 are noninverting control logic while the TPS2839/49 drivers are inverting control logic.

functional block diagram (TPS2838, TPS2839)

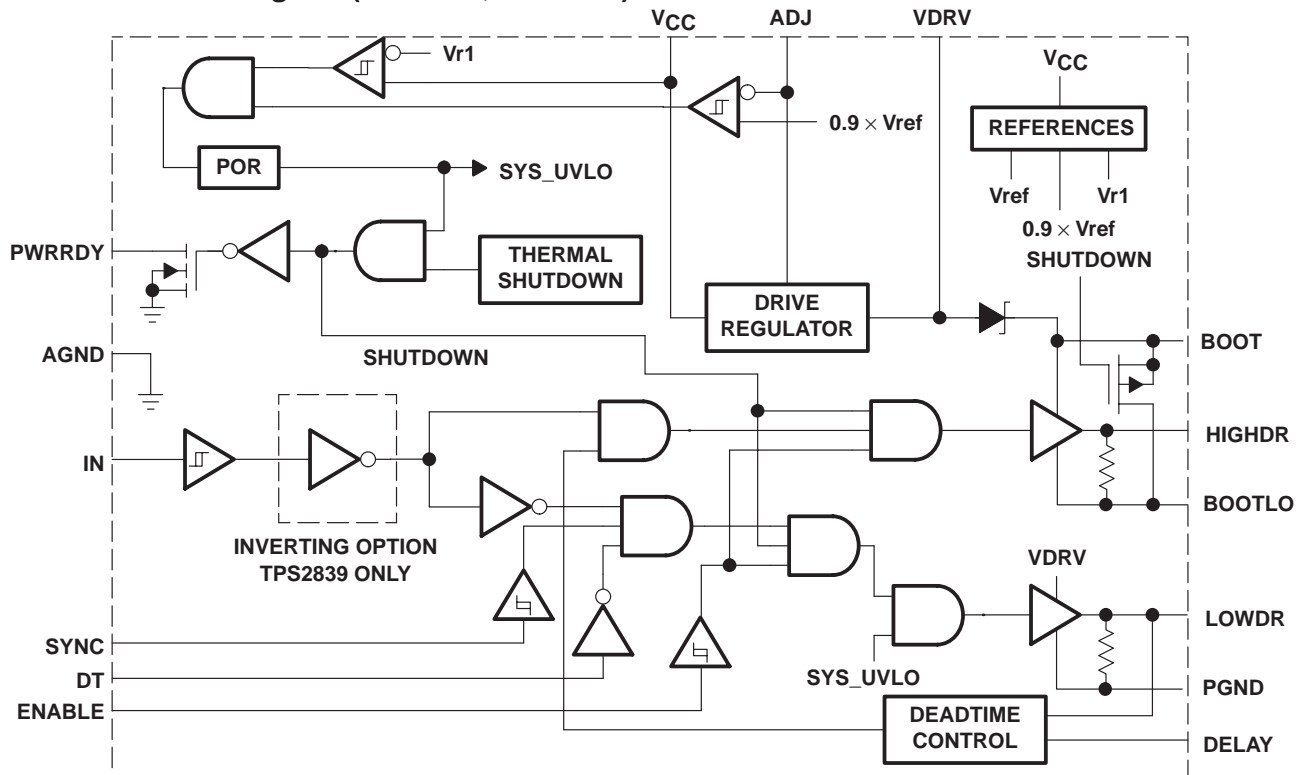

functional block diagram (TPS2848, TPS2849)

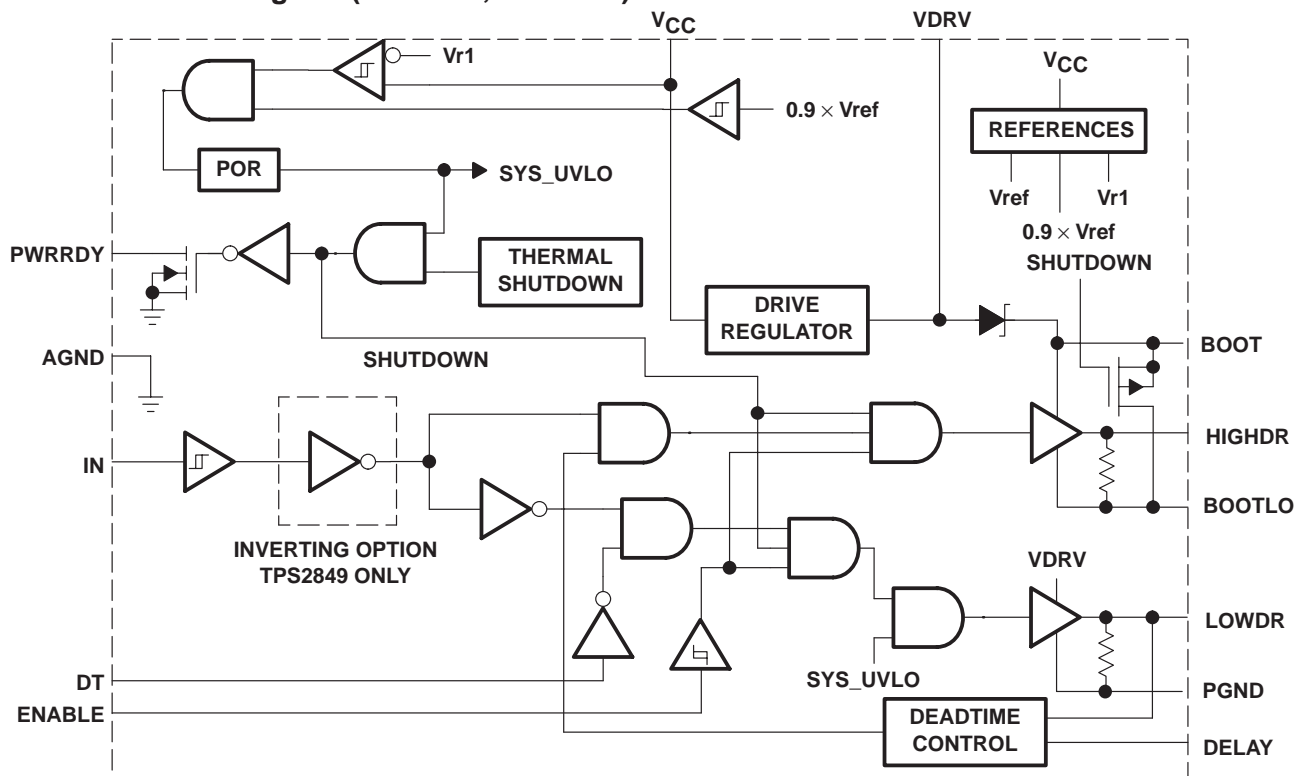

Terminal Functions

TERMINAL			DESCRIPTION
NAME	NO.		
	TPS283x	TPS284x	
ADJ	6	—	Adjust. The adjust pin is the feedback pin for the drive regulator (TPS283X only)
AGND	8	7	Analog ground
BOOT	16	14	Bootstrap. A capacitor is connected between the BOOT and BOOTLO pins to develop the floating bootstrap voltage for the high-side MOSFET. The capacitor value is typically between 0.1 μ F and 1 μ F.
BOOTLO	14	12	Boot low. This pin connects to the junction of the high-side and low-side MOSFETs.
DELAY	4	4	Delay. Connecting a capacitor between this pin and ground adjusts the deadtime for high-side driver
DT	7	6	Deadtime control. Connect DT to the junction of the high-side and low-side MOSFETs
ENABLE	1	1	Enable. If ENABLE is low, both drivers are off.
HIGHDR	15	13	High drive. This pin is the output drive for the high-side power MOSFET.
IN	2	2	Input. This pin is the input signal to the MOSFET drivers.
LOWDR	11	9	Low drive. This pin is the output drive for the low-side power MOSFET.
NC	10	5	No internal connection
PGND	9	8	Power ground. This pin is connected to the FET power ground.
PWRRDY	3	3	Power ready. This open-drain pin indicates a power good for VDRV and V_{CC} .
SYNC	5	—	Synchronous rectifier enable. If SYNC is low, the low-side driver is always off; if SYNC is high, the low-side driver provides gate drive to the low-side MOSFET.
V_{CC}	13	11	Input power supply. It is recommended that a capacitor (minimum 1 μ F) be connected from V_{CC} to PGND. Note that V_{CC} must be 2 V higher than VDRV.
VDRV	12	10	Drive regulator output voltage. It is recommended that a capacitor (minimum 1 μ F) be connected from VDRV to PGND. Note that V_{CC} must be 2 V higher than VDRV.

detailed description

low-side driver

The low-side driver is designed to drive low $r_{DS(on)}$ N-channel MOSFETs. The current rating of the driver is 4 A, source and sink.

high-side driver

The high-side driver is designed to drive low $r_{DS(on)}$ N-channel MOSFETs. The current rating of the driver is 4 A minimum, source and sink. The high-side driver can be configured as a GND-reference driver or as a floating-bootstrap driver. The internal bootstrap diode is a Schottky, for improved drive efficiency. The maximum voltage that can be applied from BOOT to ground is 30 V.

dead-time (DT) control

Dead-time control prevents shoot-through current from flowing through the main power FETs during switching transitions by controlling the turnon times of the MOSFET drivers. The high-side driver is not allowed to turn on until the gate drive voltage to the low-side FET is low, and the low-side driver is not allowed to turn on until the voltage at the junction of the power FETs (BOOTLO) is low. The TTL-compatible DT terminal connects to the junction of the power FETs.

ENABLE

The ENABLE terminal enables the drivers. When enable is low, the output drivers are low. ENABLE is a TTL-compatible digital terminal.

detailed description (continued)

IN

The IN terminal is a TTL-compatible digital terminal that is the input control signal for the drivers. The TPS2838/48 have noninverting inputs; the TPS2839/49 have inverting inputs. On the TPS2838 and TPS2848, a high on IN results in a high on HIGHDR. On the TPS2839 and TPS2849, a high on IN results in a low on HIGHDR.

SYNC (TPS283x only)

The SYNC terminal controls whether the drivers operate in synchronous or nonsynchronous mode. In synchronous mode, the low-side FET is operated as a synchronous rectifier. In nonsynchronous mode, the low-side FET is always off. SYNC is a TTL-compatible digital terminal.

PWRRDY

Depicts the status of the V_{CC} pin voltage and the driver regulator output on the open-drain PWRRDY pin.

DELAY

Adjustable high-side turnon delay from from when the low-side FET is turned off.

ADJ (TPS283x only)

Input for adjusting the driver regulator output. See the *application information* section for the adjustment formula.

absolute maximum ratings over operating free-air temperature (unless otherwise noted)†

Supply voltage range, V_{CC} (see Note 1)	-0.3 V to 16 V
Input voltage range: ADJ	-0.3 V to 7 V
BOOT to PGND (high-side driver ON)	-0.3 V to 30 V
BOOTLO to PGND	-0.3 V to 16 V
BOOT to BOOTLO	-0.3 V to 16 V
ENABLE, IN, and SYNC	-0.3 V to 16 V
VDRV, PWRRDY, and DELAY	-0.3 V to 16 V
DT	-0.3 V to 16 V
Continuous total power dissipation	See Dissipation Rating Table
Operating virtual junction temperature range, T_J	-40°C to 125°C
Storage temperature range, T_{stg}	-65°C to 150°C
Lead temperature soldering 1,6 mm (1/16 inch) from case for 10 seconds	260°C

† Stresses beyond those listed under “absolute maximum ratings” may cause permanent damage to the device. These are stress ratings only, and functional operation of the device at these or any other conditions beyond those indicated under “recommended operating conditions” is not implied. Exposure to absolute-maximum-rated conditions for extended periods may affect device reliability.

NOTE 1: Unless otherwise specified, all voltages are with respect to PGND.

TPS2838, TPS2839 TPS2848, TPS2849

SLVS367A – MARCH 2001 – REVISED JUNE 2001

DISSIPATION RATING TABLE

PACKAGE	T _A ≤ 25°C	DERATING FACTOR	T _A = 70°C	T _A = 85°C
14-pin PWP with solder†	2668	26.68 mW/°C	1467	1067
14-pin PWP without solder†	1024	10.24 mW/°C	563	409
16-pin PWP with solder†	2739	27.39 mW/°C	1506	1095
16-pin PWP without solder†	1108	11.08 mW/°C	609	443

JUNCTION-CASE THERMAL RESISTANCE TABLE

14-pin PWP	Junction-case thermal resistance	2.07 °C/W
16-pin PWP	Junction-case thermal resistance	2.07 °C/W

† Test Board Conditions:

1. Thickness: 0.062"
2. 3" × 3" (for packages < 27 mm long)
3. 4" × 4" (for packages > 27 mm long)
4. 2-oz copper traces located on the top of the board (0,071 mm thick)
5. Copper areas located on the top and bottom of the PCB for soldering
6. Power and ground planes, 1-oz copper (0,036 mm thick)
7. Thermal vias, 0,33 mm diameter, 1,5 mm pitch
8. Thermal isolation of power plane

For more information, refer to TI technical brief literature number SLMA002.

recommended operating conditions

	MIN	NOM	MAX	UNIT
Supply voltage, V _{CC}	10		15	V
Input voltage, V _I BOOT to PGND	10		29	V

**electrical characteristics over recommended operating virtual junction temperature range,
V_{CC} = 12 V, ENABLE = High, C_L = 3.3 nF (unless otherwise noted)**

supply current

PARAMETER	TEST CONDITIONS	MIN	TYP	MAX	UNIT
I _{CC} Quiescent current	V(ENABLE) = Low, V _{CC} = 13 V			425	μA
	V(ENABLE) = High, V _{CC} = 13 V			1	mA

NOTE 2: Ensured by design, not production tested.

electrical characteristics over recommended operating virtual junction temperature range,
V_{CC} = 12 V, ENABLE = High, C_L = 3.3 nF (unless otherwise noted) (continued)

dead-time control

PARAMETER	TEST CONDITIONS	MIN	TYP	MAX	UNIT
V _{IH} (LOWDR) LOWDR high-level input voltage	Over full VDRV range See Note 2	50			%VDRV
V _{IL} (LOWDR) LOWDR low-level input voltage	Over full VDRV range See Note 2			1	V
V _{IH} (DT) DT high-level input voltage	Over full V _{CC} range	2			V
V _{IL} (DT) DT low-level input voltage	Over full V _{CC} range			1	V
Deadtime delay	V(VDRV) = 4 V to 14 V See Note 2	0.5	1	1.5	ns/pF
Driver nonoverlap time (DT to LOWDR)	V(VDRV) = 4.5 V, T _J = 25°C, See Note 2	30		150	ns
	V(VDRV) = 14.5 V, T _J = 25°C, See Note 2	30		100	ns
Driver nonoverlap time (LOWDR to HIGHDR)	V(VDRV) = 4.5 V, C _L (Delay) = 50 pF, T _J = 25°C, See Note 2	75		180	ns
	V(VDRV) = 14.5 V, C _L (Delay) = 50 pF, T _J = 25°C, See Note 2	58		125	
Driver nonoverlap time (LOWDR to HIGHDR)	V(VDRV) = 4.5 V, C _L (Delay) = 0 pF, T _J = 25°C, See Note 2	50		125	ns
	V(VDRV) = 14.5 V, C _L (Delay) = 0 pF, T _J = 25°C, See Note 2	30		100	

NOTE 2: Ensured by design, not production tested.

high-side driver

PARAMETER	TEST CONDITIONS	MIN	TYP	MAX	UNIT
Peak output current	V(BOOT) - V(BOOTLO) = 4 V, See Note 2	V(HIGHDR) = 0.5 V (src)	1	1.3	A
		V(HIGHDR) = 4 V (sink)	2	2.4	
	V(BOOT) - V(BOOTLO) = 8 V, See Note 2	V(HIGHDR) = 0.5 V (src)	2	2.4	
		V(HIGHDR) = 8 V (sink)	2	3.3	
	V(BOOT) - V(BOOTLO) = 14 V, See Note 2	V(HIGHDR) = 0.5 V (src)	2	3.9	
		V(HIGHDR) = 14 V (sink)	2	4.4	
r _o Output resistance	V(BOOT) - V(BOOTLO) = 4.5 V, T _J = 25°C	V(HIGHDR) = 4 V (src)		45	Ω
		V(HIGHDR) = 0.5 V (sink)		6	
	V(BOOT) - V(BOOTLO) = 7.5 V, T _J = 25°C	V(HIGHDR) = 7 V (src)		26	
		V(HIGHDR) = 0.5 V (sink)		5	
	V(BOOT) - V(BOOTLO) = 11.5 V, T _J = 25°C	V(HIGHDR) = 11 V (src)		20	
		V(HIGHDR) = 0.5 V (sink)		4	
HIGHDRV-to-BOOTLO resistor			250	kΩ	
t _r /t _f Rise and fall time (see Notes 2 and 3)	C _L = 3.3 nF, V(BOOTLO) = GND, T _J = 125°C	V(BOOT) = 4 V		85	ns
		V(BOOT) = 8 V		70	
		V(BOOT) = 14 V		65	
	C _L = 10 nF, V(BOOTLO) = GND, T _J = 125°C	V(BOOT) = 4 V		170	
		V(BOOT) = 8 V		140	
		V(BOOT) = 14 V		100	
t _{PHL} Propagation delay time, HIGHDR going low (excluding deadtime)	V(BOOTLO) = GND, T _J = 125°C, See Notes 2 and 3	V(BOOT) = 4 V		120	ns
		V(BOOT) = 8 V		100	
		V(BOOT) = 14 V		80	

NOTES: 2: Ensured by design, not production tested.

3. The pullup/pulldown circuits of the drivers are bipolar and MOSFET transistors in parallel. The peak output current rating is the combined current from the bipolar and MOSFET transistors. The output resistance is the r_{DS(on)} of the MOSFET transistor when the voltage on the driver output is less than the saturation voltage of the bipolar transistor.

**electrical characteristics over recommended operating virtual junction temperature range,
 $V_{CC} = 12\text{ V}$, $\text{ENABLE} = \text{High}$, $C_L = 3.3\text{ nF}$ (unless otherwise noted) (continued)**

low-side driver

PARAMETER		TEST CONDITIONS	MIN	TYP	MAX	UNIT
Peak output current	$V_{(\text{VDRV})} = 4\text{ V}$, $T_J = 25^\circ\text{C}$, See Note 2	$V_{(\text{LOWDR})} = 0.5\text{ V (src)}$	1	1.6		A
		$V_{(\text{LOWDR})} = 4\text{ V (sink)}$	2	2.4		
	$V_{(\text{VDRV})} = 8\text{ V}$, $T_J = 25^\circ\text{C}$, See Note 2	$V_{(\text{HIGHDR})} = 0.5\text{ V (src)}$	2	2.4		
		$V_{(\text{HIGHDR})} = 8\text{ V (sink)}$	2	3.3		
	$V_{(\text{VDRV})} = 14\text{ V (src)}$, $T_J = 25^\circ\text{C}$, See Note 2	$V_{(\text{HIGHDR})} = 0.5\text{ V (src)}$	2	3.9		
		$V_{(\text{HIGHDR})} = 14\text{ V (sink)}$	2	4.4		
r_o Output resistance	$V_{(\text{VDRV})} = 4.5\text{ V}$, $T_J = 25^\circ\text{C}$	$V_{(\text{LOWDR})} = 4\text{ V (src)}$			30	Ω
		$V_{(\text{LOWDR})} = 0.5\text{ V (sink)}$			8	
	$V_{(\text{VDRV})} = 7.5\text{ V}$, $T_J = 25^\circ\text{C}$	$V_{(\text{LOWDR})} = 7\text{ V (src)}$			25	
		$V_{(\text{LOWDR})} = 0.5\text{ V (sink)}$			7	
	$V_{(\text{VDRV})} = 11.5\text{ V}$, $T_J = 25^\circ\text{C}$	$V_{(\text{LOWDR})} = 11\text{ V (src)}$			22	
		$V_{(\text{LOWDR})} = 0.5\text{ V (sink)}$			6	
LOWDR-to-PGND resistor				250		k Ω
t_r/t_f Rise and fall time	$C_L = 3.3\text{ nF}$, $T_J = 125^\circ\text{C}$, See Note 2	$V_{(\text{VDRV})} = 4\text{ V}$			60	ns
		$V_{(\text{VDRV})} = 8\text{ V}$			50	
		$V_{(\text{VDRV})} = 14\text{ V}$			40	
	$C_L = 10\text{ nF}$, $T_J = 125^\circ\text{C}$, See Note 2	$V_{(\text{VDRV})} = 4\text{ V}$			110	
		$V_{(\text{VDRV})} = 8\text{ V}$			100	
		$V_{(\text{VDRV})} = 14\text{ V}$			80	
t_{PLH} Propagation delay time, LOWDR going high (excluding deadtime)	$T_J = 125^\circ\text{C}$, See Notes 2 and 3	$V_{(\text{VDRV})} = 4\text{ V}$			110	ns
		$V_{(\text{VDRV})} = 8\text{ V}$			90	ns
		$V_{(\text{VDRV})} = 14\text{ V}$			80	ns

NOTES: 2: Ensured by design, not production tested.

3: The pullup/pulldown circuits of the drivers are bipolar and MOSFET transistors in parallel. The peak output current rating is the combined current from the bipolar and MOSFET transistors. The output resistance is the $r_{\text{DS(on)}}$ of the MOSFET transistor when the voltage on the driver output is less than the saturation voltage of the bipolar transistor.

V_{CC} undervoltage lockout

PARAMETER		TEST CONDITIONS	MIN	TYP	MAX	UNIT
Start threshold voltage					10.3	V
Stop threshold voltage			7.5			V
V_{hys}	Hysteresis voltage		1	1.5		V
t_{pd}	Propagation delay time	50-mV overdrive, See Note 2		300	1000	ns
t_d	Falling-edge delay time	See Note 2	2		5	us

NOTE 2: Ensured by design, not production tested.

electrical characteristics over recommended operating virtual junction temperature range,
V_{CC} = 12 V, ENABLE = High, C_L = 3.3 nF (unless otherwise noted) (continued)

digital control (IN, ENABLE, SYNC)

PARAMETER		TEST CONDITIONS	MIN	TYP	MAX	UNIT
V _{IH}	High-level input voltage	IN	Over full V _{CC} range			V
		ENABLE, SYNC	Over full V _{CC} range			V
V _{IL}	Low-level input voltage	IN	Over full V _{CC} range			V
		ENABLE, SYNC	Over full V _{CC} range			V
ENABLE propagation delay time		See Note 2	2		7	μs

NOTE 2: Ensured by design, not production tested.

thermal shutdown

PARAMETER		TEST CONDITIONS	MIN	TYP	MAX	UNIT
Thermal shutdown		See Note 2	155	170	185	°C
t _d	Falling edge delay time	See Note 2	10		20	μs

NOTE 2: Ensured by design, not production tested.

drive regulator

PARAMETER		TEST CONDITIONS	MIN	TYP	MAX	UNIT
Recommended output voltage			4		14	V
V _O	Output voltage	V _{CC} = 10 V to 15 V, I _O = 5 mA to 150 mA	-2		2	%nom
V _{ref}	Reference voltage	V _{CC} = 10 V to 15 V		1.235		V
Dropout voltage		V _{CC} = 10 V, I _O = 150 mA See Note 2		1000	1100	mV
Line regulation		V _{CC} = 10 V to 15 V, I _O = 5 mA		0.2		%/V
Load regulation		V _{CC} = 10 V, I _O = 5 mA to 150 mA		2		%
Current limit		V _{CC} = 8 V		0.5	0.6	A
PWRRDY saturation voltage		I _O = 5 mA			0.8	V
I _{lkg}	Leakage current	V _I (PWRRDY) = 4.5 V			1	μA

drive regulator undervoltage lockout

PARAMETER		TEST CONDITIONS	MIN	TYP	MAX	UNIT
Start threshold voltage		See Note 2			85	%Vref
Stop threshold voltage		See Note 2	80			%Vref
V _{hys}	Hysteresis voltage	See Note 2	2.5	5		%Vref
t _{pd}	Propagation delay time	50-mV overdrive, See Note 2		300	1000	ns
Falling-edge delay time		See Note 2	2		5	μs
Power on reset time		See Note 2		100	1000	μs

NOTE 2: Ensured by design, not production tested.

PARAMETER MEASUREMENT INFORMATION

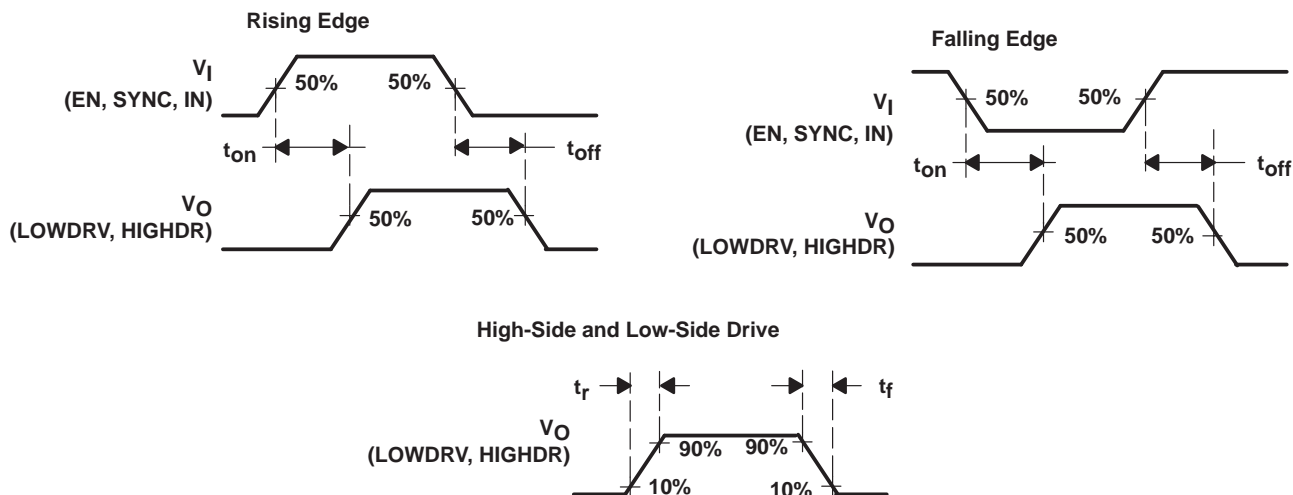

Figure 1. Voltage Waveforms

TYPICAL CHARACTERISTICS

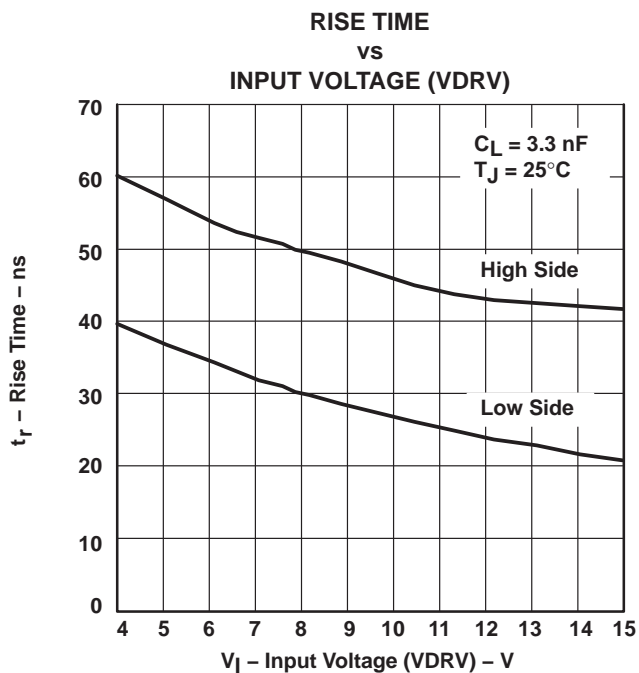

Figure 2

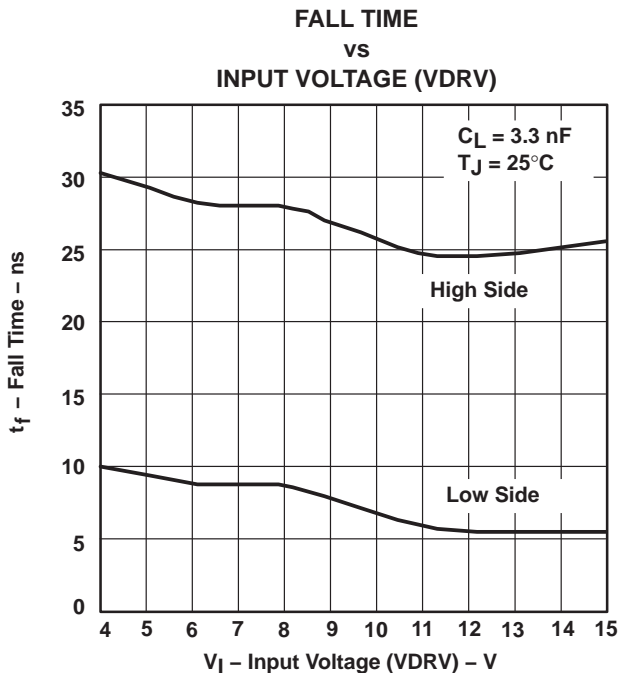
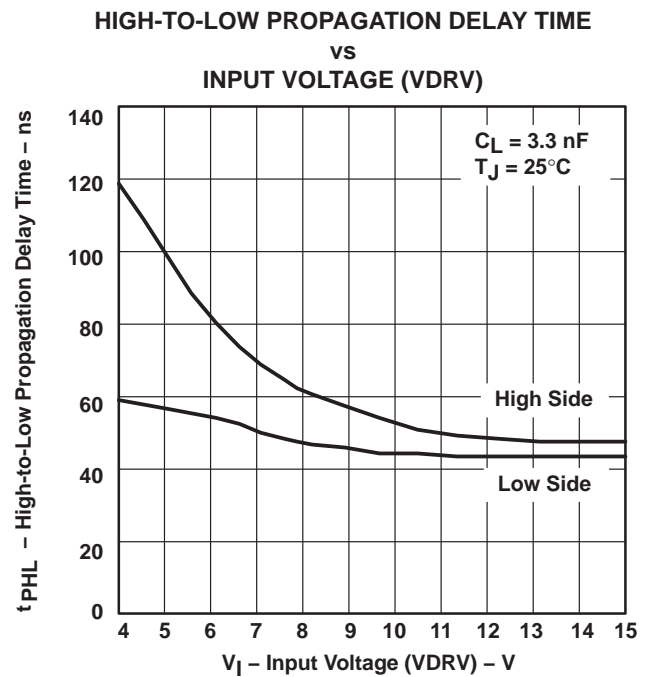
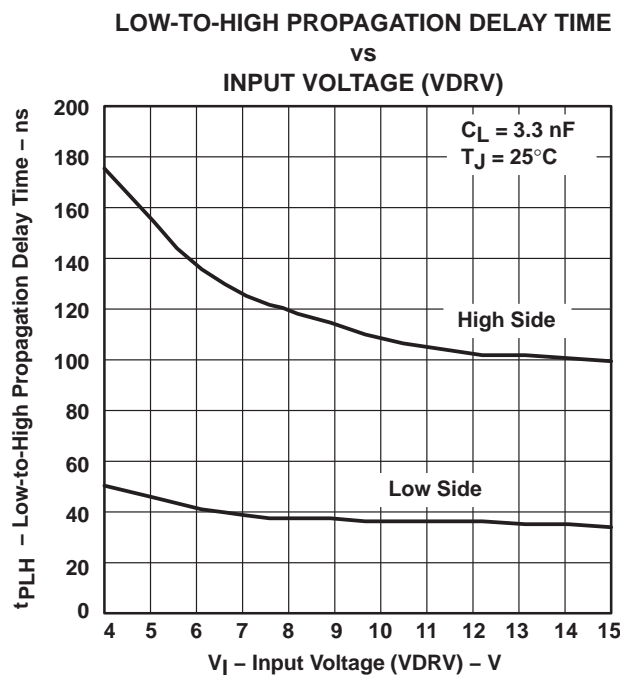
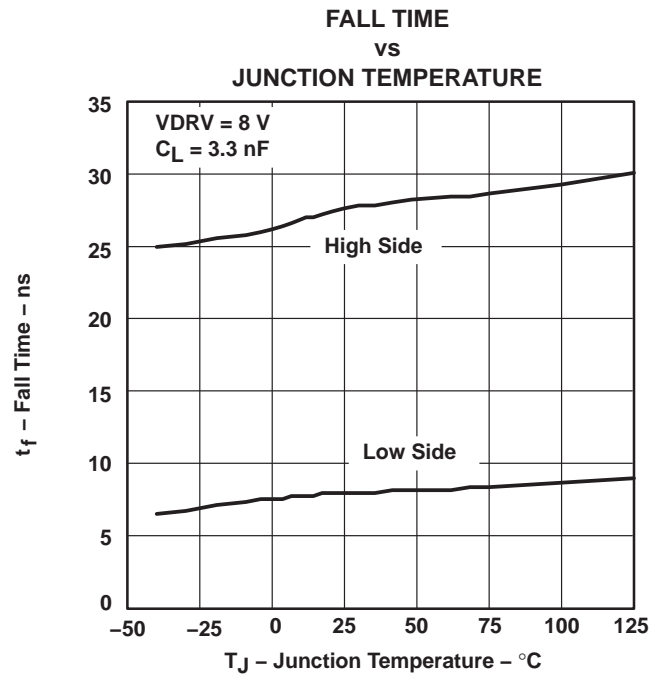
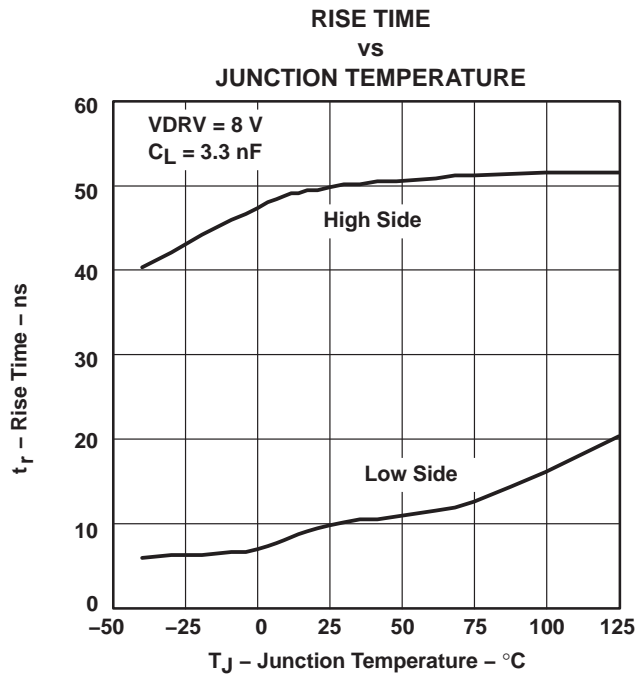

Figure 3

TYPICAL CHARACTERISTICS



TYPICAL CHARACTERISTICS

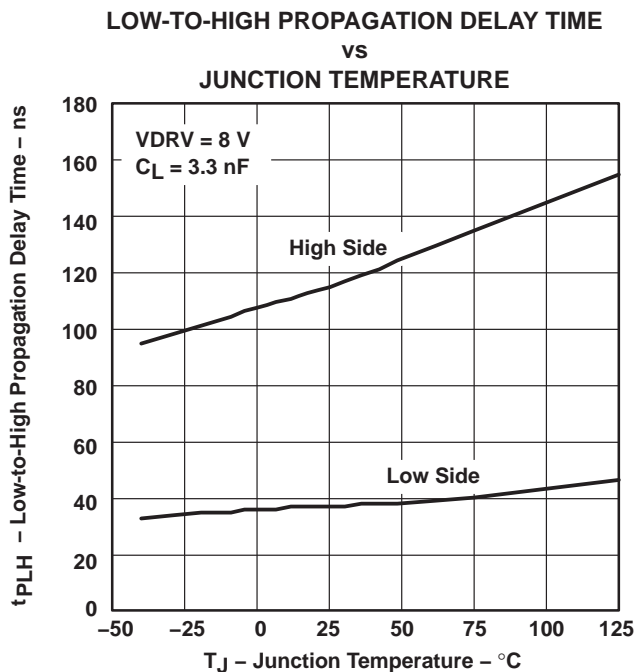

Figure 8

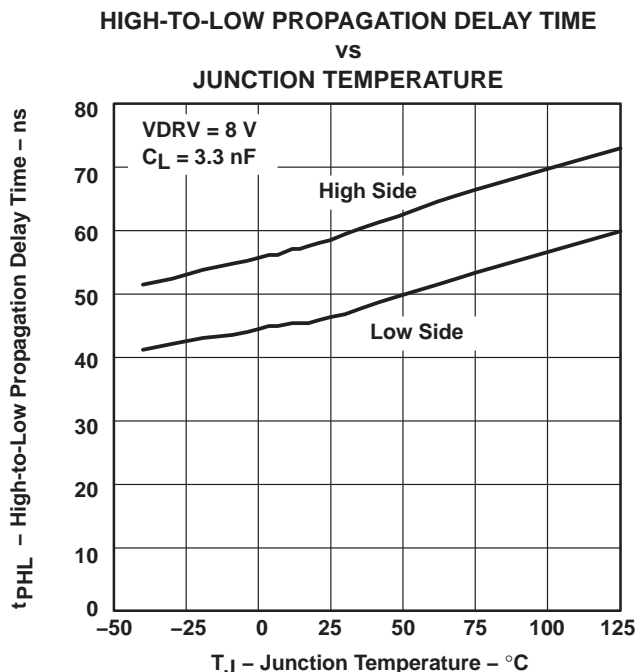

Figure 9

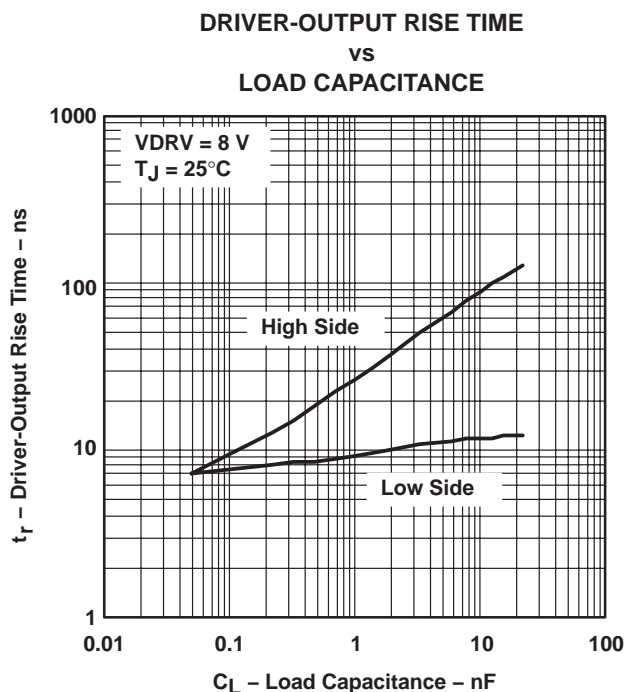

Figure 10

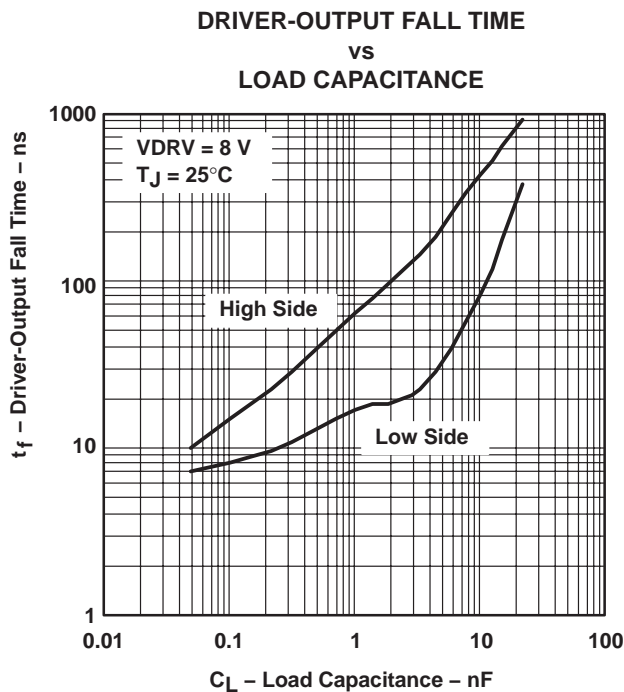

Figure 11

TYPICAL CHARACTERISTICS

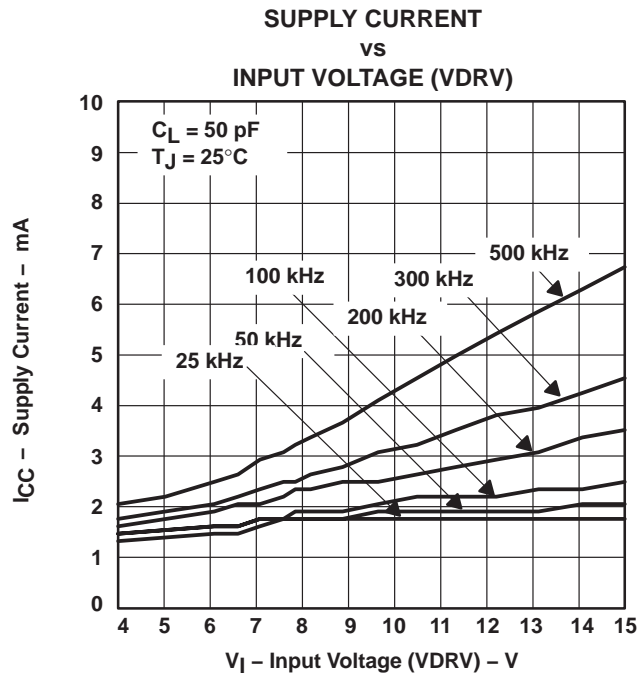

Figure 12

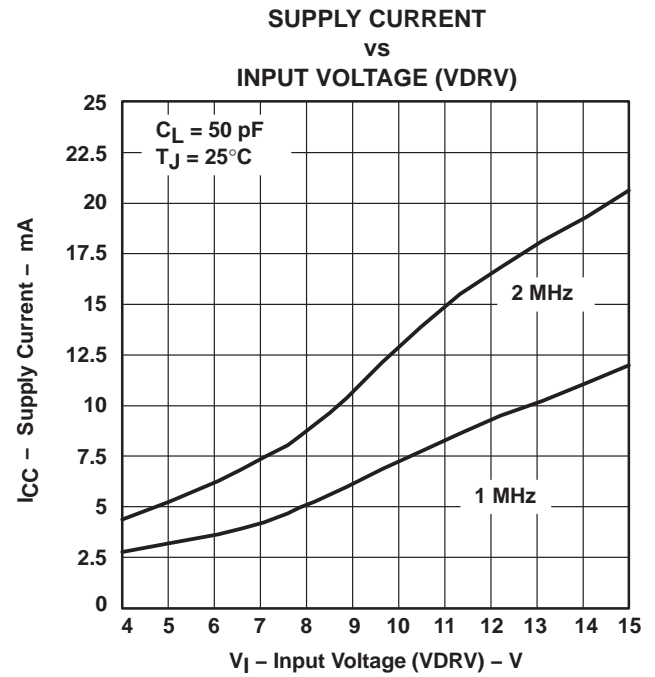

Figure 13

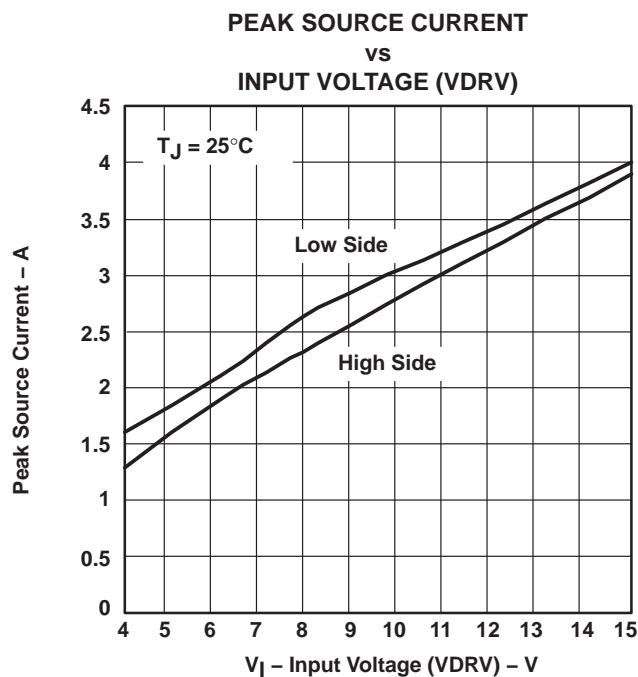

Figure 14

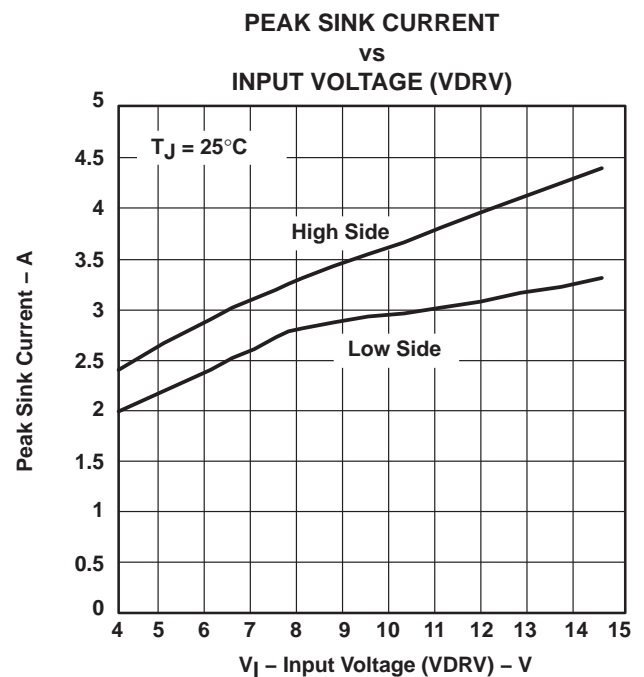

Figure 15

TYPICAL CHARACTERISTICS

START/STOP V_{CC} UNDERVOLTAGE LOCKOUT
 vs
 JUNCTION TEMPERATURE

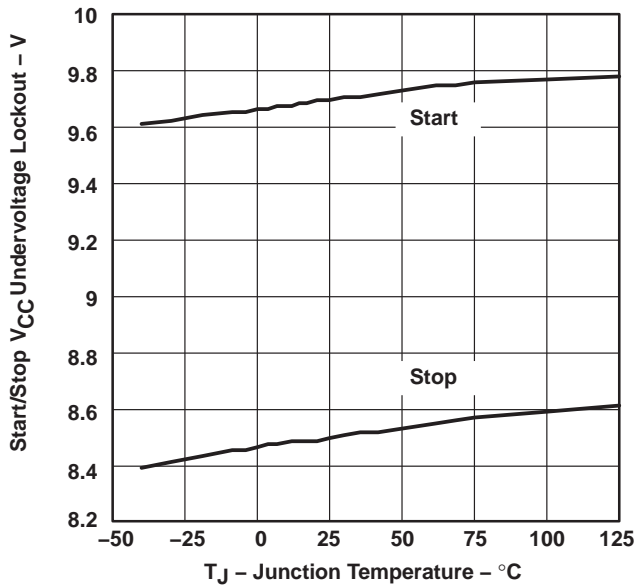

Figure 16

BOOTSTRAP SCHOTTKY DIODE
 INPUT CURRENT
 vs
 OUTPUT VOLTAGE

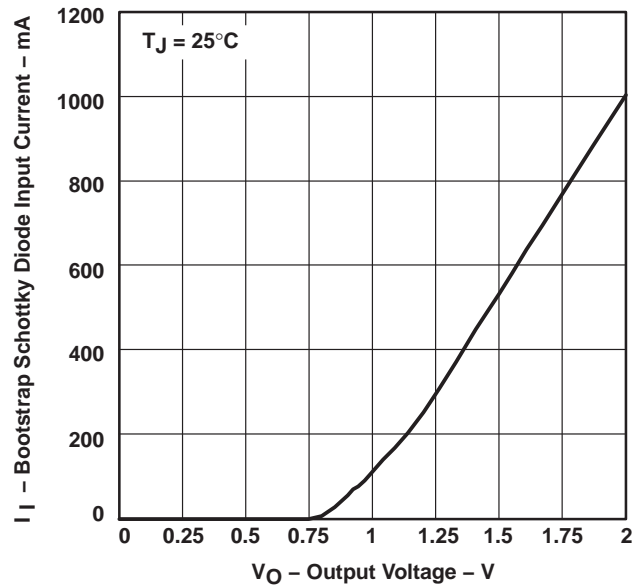

Figure 17

DELAY TIME (DEAD TIME)
 vs
 INPUT VOLTAGE (VDRV)

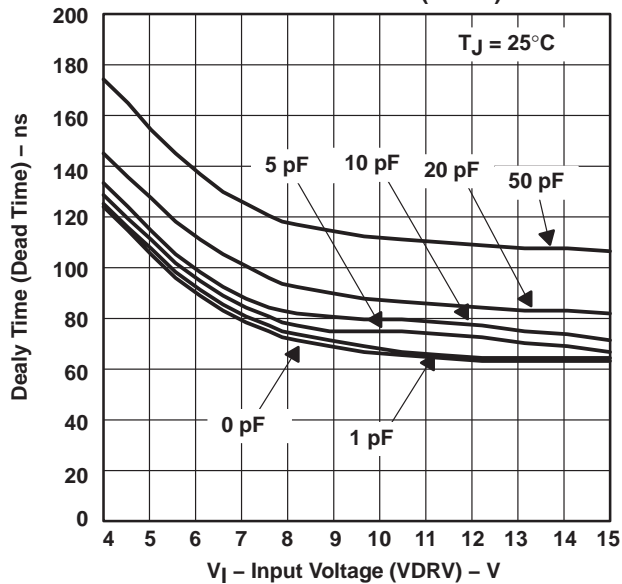

Figure 18

DELAY TIME
 vs
 JUNCTION TEMPERATURE

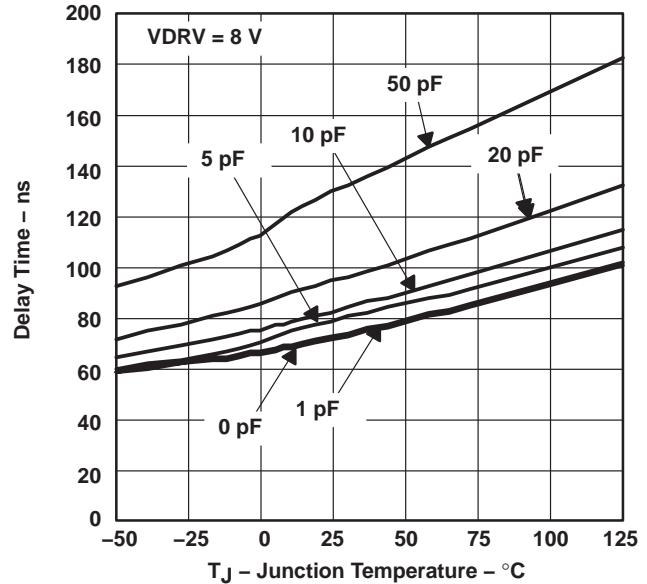

Figure 19

TYPICAL CHARACTERISTICS

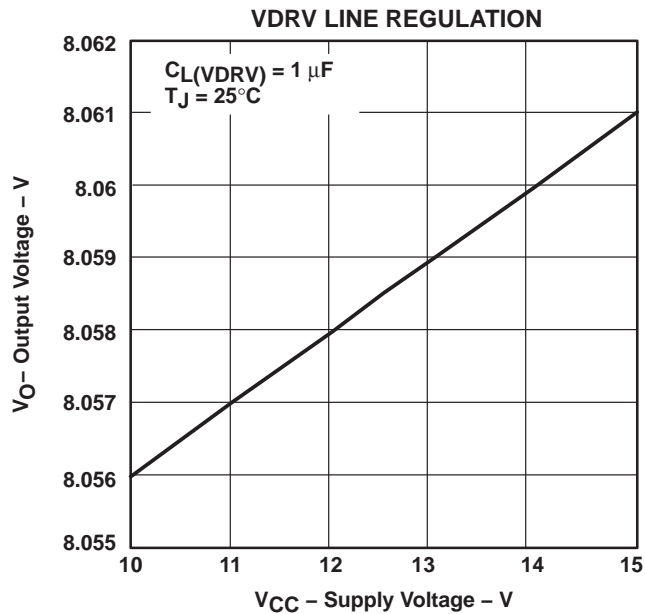

Figure 20

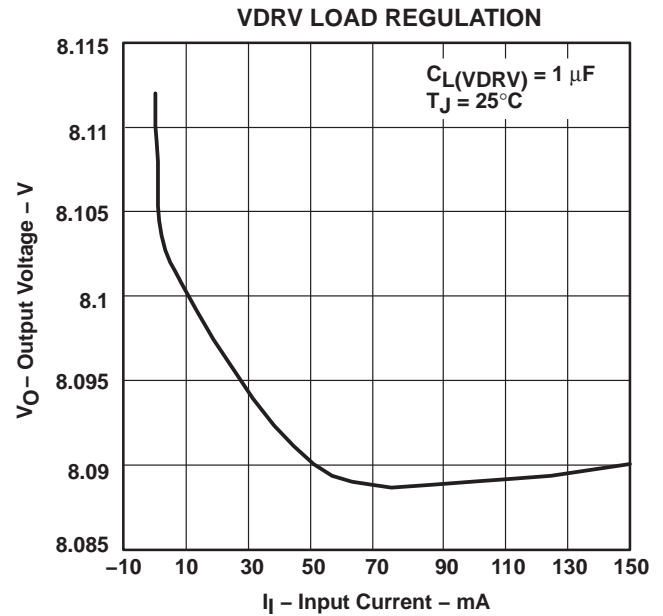
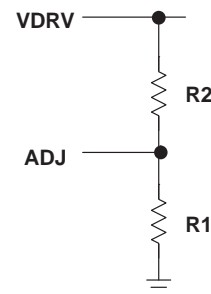

Figure 21

APPLICATION INFORMATION

Figure 22 shows the circuit schematic of a 100-kHz synchronous-buck converter implemented with a TL5001ACD pulse-width-modulation (PWM) controller and a TPS2838 driver. The converter operates over an input range from 4.5 V to 12 V and has a 3.3-V output. The circuit can supply 3-A continuous load. The converter achieves an efficiency of 94% for V_{IN} = 5 V, I_L = 1 A, and 93% for V_{IN} = 5 V, I_L = 3 A.

R1 (kΩ)	R2 (kΩ)	VDRV Voltage (V)
30	67	4
30	91	5
30	165	8
30	261	12
30	322	14.5



To set the regulator voltage (TPS2838/39) use the following equation:

$$R2 = \left(\frac{R1}{1.235} \times VDRV \right) - R1$$

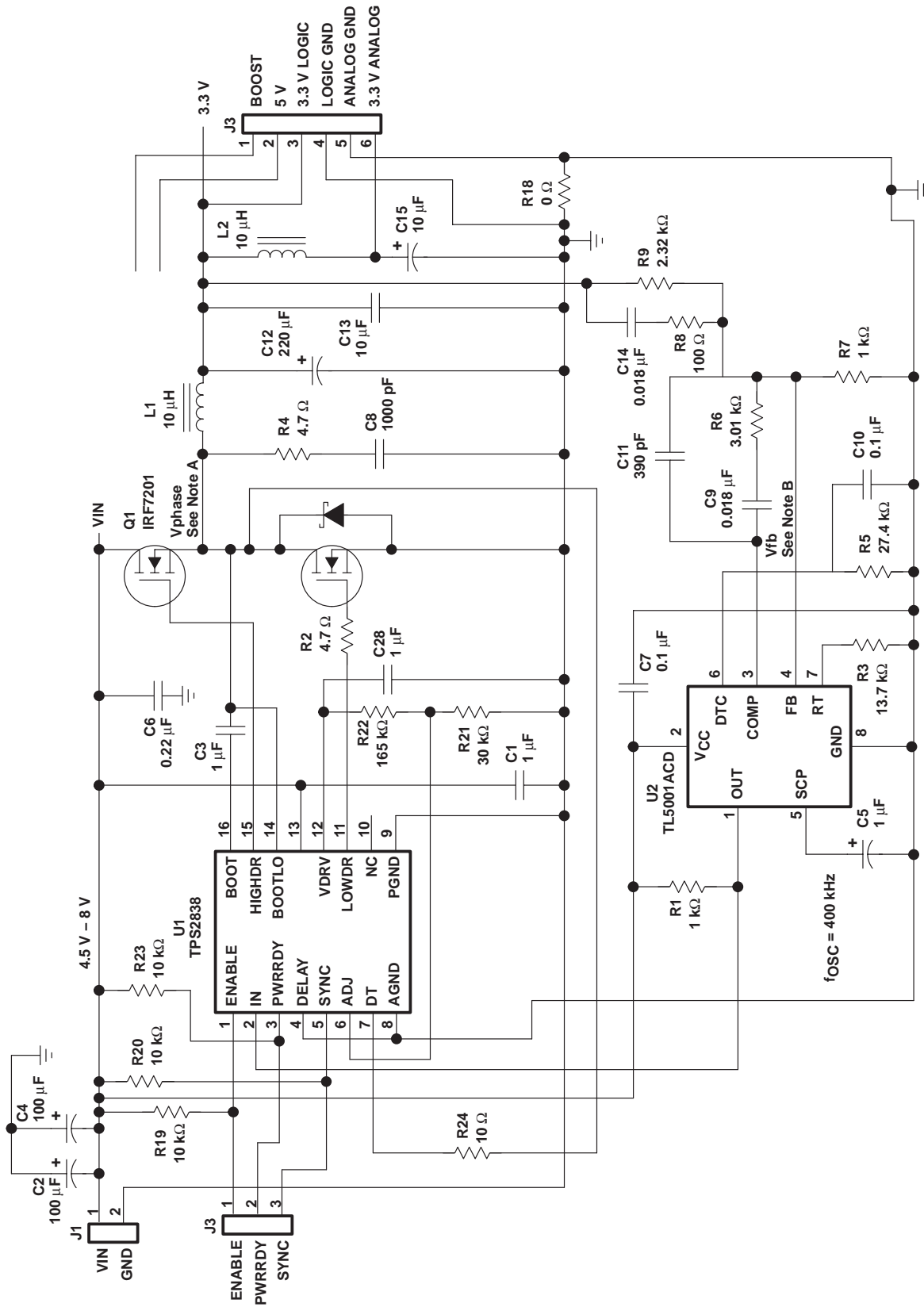

NOTES:
A. Node Vphase generates RFI. Make this as contained as possible.
B. Node Vphase is very sensitive. Make this as short as possible.

Figure 22. 3.3-V 3-A Synchronous-Buck Converter Circuit

APPLICATION INFORMATION

Great care should be taken when laying out the PC board. The power-processing section is the most critical and will generate large amounts of EMI if not properly configured. The junction of Q1, Q2, and L1 should be very tight. The connection from Q1 drain to the positive sides of C5, C10, and C11 and the connection from Q2 source to the negative sides of C5, C10, and C11 should be as short as possible. The negative terminals of C7 and C12 should also be connected to Q2 source.

Next, the traces from the MOSFET driver to the power switches should be considered. The BOOTLO signal from the junction of Q1 and Q2 carries the large gate drive current pulses and should be as heavy as the gate drive traces. The bypass capacitor (C14) should be tied directly across V_{CC} and PGND.

The next most sensitive node is the FB node on the controller (terminal 4 on the TL5001A). This node is very sensitive to noise pickup and should be isolated from the high-current power stage and be as short as possible. The ground around the controller and low-level circuitry should be tied to the power ground as the output. If these three areas are properly laid out, the rest of the circuit should not have other EMI problems and the power supply will be relatively free of noise.

PACKAGING INFORMATION

Orderable Device	Status (1)	Package Type	Package Drawing	Pins	Package Qty	Eco Plan (2)	Lead finish/ Ball material (6)	MSL Peak Temp (3)	Op Temp (°C)	Device Marking (4/5)	Samples
TPS2838PWP	ACTIVE	HTSSOP	PWP	16	90	RoHS & Green	NIPDAU	Level-2-260C-1 YEAR	-40 to 125	TPS2838	Samples

(1) The marketing status values are defined as follows:

ACTIVE: Product device recommended for new designs.

LIFEBUY: TI has announced that the device will be discontinued, and a lifetime-buy period is in effect.

NRND: Not recommended for new designs. Device is in production to support existing customers, but TI does not recommend using this part in a new design.

PREVIEW: Device has been announced but is not in production. Samples may or may not be available.

OBSOLETE: TI has discontinued the production of the device.

(2) **RoHS:** TI defines "RoHS" to mean semiconductor products that are compliant with the current EU RoHS requirements for all 10 RoHS substances, including the requirement that RoHS substance do not exceed 0.1% by weight in homogeneous materials. Where designed to be soldered at high temperatures, "RoHS" products are suitable for use in specified lead-free processes. TI may reference these types of products as "Pb-Free".

RoHS Exempt: TI defines "RoHS Exempt" to mean products that contain lead but are compliant with EU RoHS pursuant to a specific EU RoHS exemption.

Green: TI defines "Green" to mean the content of Chlorine (Cl) and Bromine (Br) based flame retardants meet JS709B low halogen requirements of <=1000ppm threshold. Antimony trioxide based flame retardants must also meet the <=1000ppm threshold requirement.

(3) MSL, Peak Temp. - The Moisture Sensitivity Level rating according to the JEDEC industry standard classifications, and peak solder temperature.

(4) There may be additional marking, which relates to the logo, the lot trace code information, or the environmental category on the device.

(5) Multiple Device Markings will be inside parentheses. Only one Device Marking contained in parentheses and separated by a "~" will appear on a device. If a line is indented then it is a continuation of the previous line and the two combined represent the entire Device Marking for that device.

(6) Lead finish/Ball material - Orderable Devices may have multiple material finish options. Finish options are separated by a vertical ruled line. Lead finish/Ball material values may wrap to two lines if the finish value exceeds the maximum column width.

Important Information and Disclaimer: The information provided on this page represents TI's knowledge and belief as of the date that it is provided. TI bases its knowledge and belief on information provided by third parties, and makes no representation or warranty as to the accuracy of such information. Efforts are underway to better integrate information from third parties. TI has taken and continues to take reasonable steps to provide representative and accurate information but may not have conducted destructive testing or chemical analysis on incoming materials and chemicals. TI and TI suppliers consider certain information to be proprietary, and thus CAS numbers and other limited information may not be available for release.

In no event shall TI's liability arising out of such information exceed the total purchase price of the TI part(s) at issue in this document sold by TI to Customer on an annual basis.

TUBE

*All dimensions are nominal

Device	Package Name	Package Type	Pins	SPQ	L (mm)	W (mm)	T (μm)	B (mm)
TPS2838PWP	PWP	HTSSOP	16	90	530	10.2	3600	3.5

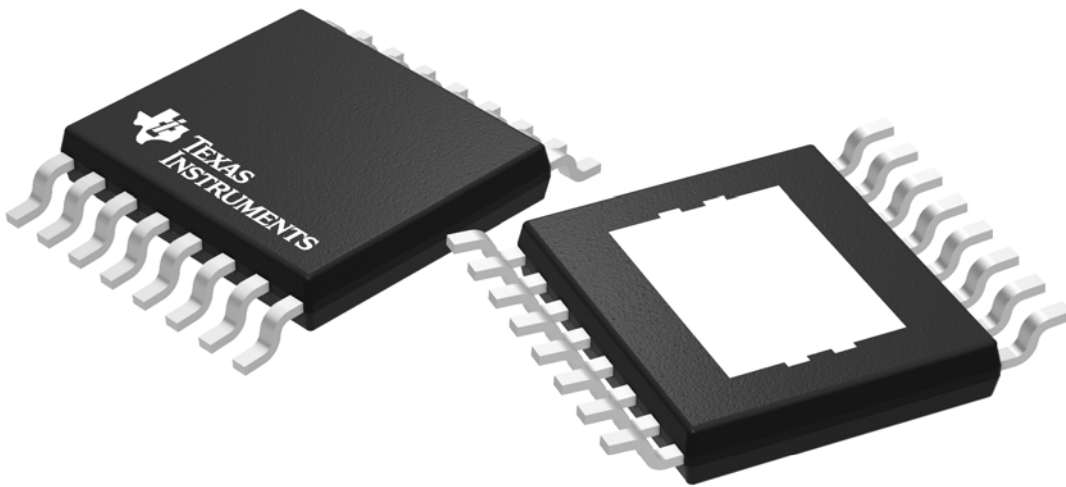

Images above are just a representation of the package family, actual package may vary.
Refer to the product data sheet for package details.

IMPORTANT NOTICE AND DISCLAIMER

TI PROVIDES TECHNICAL AND RELIABILITY DATA (INCLUDING DATA SHEETS), DESIGN RESOURCES (INCLUDING REFERENCE DESIGNS), APPLICATION OR OTHER DESIGN ADVICE, WEB TOOLS, SAFETY INFORMATION, AND OTHER RESOURCES "AS IS" AND WITH ALL FAULTS, AND DISCLAIMS ALL WARRANTIES, EXPRESS AND IMPLIED, INCLUDING WITHOUT LIMITATION ANY IMPLIED WARRANTIES OF MERCHANTABILITY, FITNESS FOR A PARTICULAR PURPOSE OR NON-INFRINGEMENT OF THIRD PARTY INTELLECTUAL PROPERTY RIGHTS.

These resources are intended for skilled developers designing with TI products. You are solely responsible for (1) selecting the appropriate TI products for your application, (2) designing, validating and testing your application, and (3) ensuring your application meets applicable standards, and any other safety, security, regulatory or other requirements.

These resources are subject to change without notice. TI grants you permission to use these resources only for development of an application that uses the TI products described in the resource. Other reproduction and display of these resources is prohibited. No license is granted to any other TI intellectual property right or to any third party intellectual property right. TI disclaims responsibility for, and you will fully indemnify TI and its representatives against, any claims, damages, costs, losses, and liabilities arising out of your use of these resources.

TI's products are provided subject to [TI's Terms of Sale](#) or other applicable terms available either on [ti.com](https://www.ti.com) or provided in conjunction with such TI products. TI's provision of these resources does not expand or otherwise alter TI's applicable warranties or warranty disclaimers for TI products.

TI objects to and rejects any additional or different terms you may have proposed.

Mailing Address: Texas Instruments, Post Office Box 655303, Dallas, Texas 75265
Copyright © 2024, Texas Instruments Incorporated

Looking for pricing, stock, or lifecycle information?

Click below to explore more details on WIN SOURCE:

 [View TPS2848PWP](#) on WIN SOURCE

 [Texas Instruments](#) Information

Optimize Your Supply Chain with WIN SOURCE Solutions

-  Global Sourcing Solution
-  Obsolete Management
-  Cost Control Management
-  Shortage Management
-  Alternative Solution
-  Excess Inventory Management