



**THE DATASHEET OF  
TLV2252AQDRG4Q1**



# TLV225x-Q1, TLV225xA-Q1 Advanced LinCMOS™ RAIL-TO-RAIL VERY LOW-POWER OPERATIONAL AMPLIFIERS

SGLS192B – OCTOBER 2003 – REVISED APRIL 2008

- Qualified for Automotive Applications
- ESD Protection Exceeds 2000 V Per MIL-STD-883, Method 3015; Exceeds 150 V (TLV2252/52A) and 100 V (TLV2254/54A) Using Machine Model (C = 200 pF, R = 0)
- Output Swing Includes Both Supply Rails
- Low Noise . . . 19 nV/√Hz Typ at f = 1 kHz
- Low Input Bias Current . . . 1 pA Typ
- Fully Specified for Both Single-Supply and Split-Supply Operation
- Very Low Power . . . 34 μA Per Channel Typ
- Common-Mode Input Voltage Range Includes Negative Rail
- Low Input Offset Voltage  
850 μV Max at T<sub>A</sub> = 25°C
- Wide Supply Voltage Range  
2.7 V to 16 V
- Macromodel Included

## description

The TLV2252 and TLV2254 are dual and quadruple low-voltage operational amplifiers from Texas Instruments. Both devices exhibit rail-to-rail output performance for increased dynamic range in single- or split-supply applications. The TLV225x family consumes only 34 μA of supply current per channel. This micropower operation makes them good choices for battery-powered applications. This family is fully characterized at 3 V and 5 V and is optimized for low-voltage applications. The noise performance has been dramatically improved over previous generations of CMOS amplifiers. The TLV225x has a noise level of 19 nV/√Hz at 1kHz, four times lower than competitive micropower solutions.

The TLV225x, exhibiting high input impedance and low noise, are excellent for small-signal conditioning for high-impedance sources, such as piezoelectric transducers. Because of the micropower dissipation levels combined with 3-V operation, these devices work well in hand-held monitoring and remote-sensing applications. In addition, the rail-to-rail output feature with single or split supplies makes this family a great choice when interfacing with analog-to-digital converters (ADCs). For precision applications, the TLV225xA family is available and has a maximum input offset voltage of 850 μV.

The TLV2252/4 also make great upgrades to the TLV2322/4 in standard designs. They offer increased output dynamic range, lower noise voltage, and lower input offset voltage. This enhanced feature set allows them to be used in a wider range of applications. For applications that require higher output drive and wider input voltage range, see the TLV2432 and TLV2442 devices. If your design requires single amplifiers, please see the TLV2211/21/31 family. These devices are single rail-to-rail operational amplifiers in the SOT-23 package. Their small size and low power consumption, make them ideal for high density, battery-powered equipment.

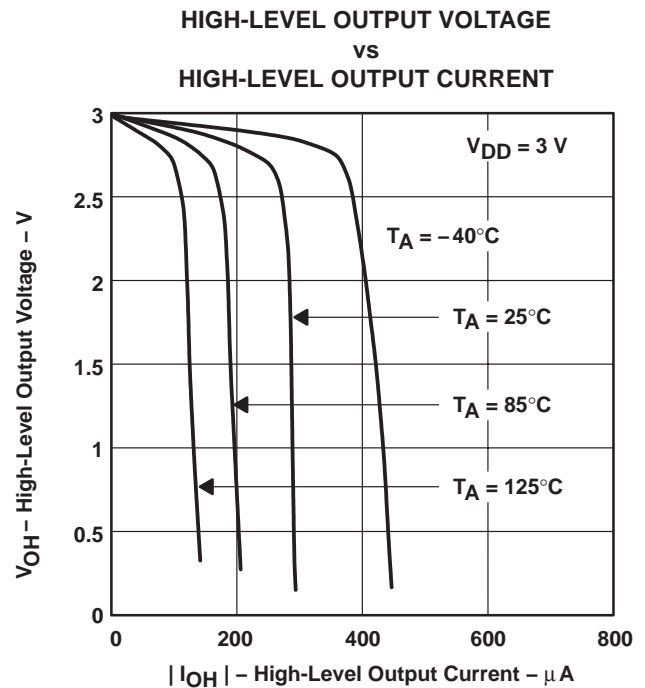


Figure 1



Please be aware that an important notice concerning availability, standard warranty, and use in critical applications of Texas Instruments semiconductor products and disclaimers thereto appears at the end of this data sheet.

Advanced LinCMOS is a trademark of Texas Instruments.

PRODUCTION DATA information is current as of publication date. Products conform to specifications per the terms of Texas Instruments standard warranty. Production processing does not necessarily include testing of all parameters.



POST OFFICE BOX 655303 • DALLAS, TEXAS 75265

Copyright © 2008 Texas Instruments Incorporated

# TLV225x-Q1, TLV225xA-Q1

## Advanced LinCMOS™ RAIL-TO-RAIL

### VERY LOW-POWER OPERATIONAL AMPLIFIERS

SGLS192B – OCTOBER 2003 – REVISED APRIL 2008

#### ORDERING INFORMATION†

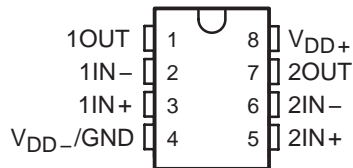
T <sub>A</sub>	V <sub>IO</sub> max AT 25°C	PACKAGE‡		ORDERABLE PART NUMBER	TOP-SIDE MARKING
-40°C to 125°C	850 µV	SOIC (D)	Tape and reel	TLV2252AQDRQ1	2252AQ
		TSSOP (PW)	Tape and reel	TLV2252AQPWRQ1§	
	1500 µV	SOIC (D)	Tape and reel	TLV2252QDRQ1	2252Q1
		TSSOP (PW)	Tape and reel	TLV2252QPWRQ1§	
-40°C to 125°C	850 µV	SOIC (D)	Tape and reel	TLV2254AQDRQ1	TLV2254AQ1
		TSSOP (PW)	Tape and reel	TLV2254AQPWRQ1§	
	1500 µV	SOIC (D)	Tape and reel	TLV2254QDRQ1	TLV2254Q1
		TSSOP (PW)	Tape and reel	TLV2254QPWRQ1§	

† For the most current package and ordering information, see the Package Option Addendum at the end of this document, or see the TI web site at <http://www.ti.com>.

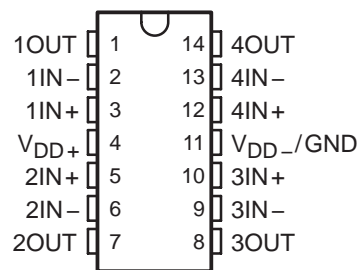
‡ Package drawings, thermal data, and symbolization are available at <http://www.ti.com/packaging>.

§ Product preview

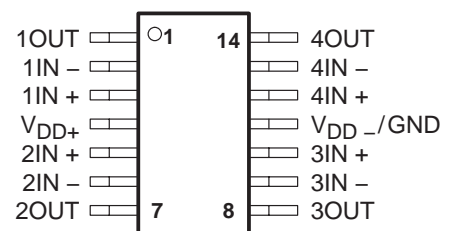
**TLV2252, TLV2252A**  
**D OR PW PACKAGE**  
**(TOP VIEW)**



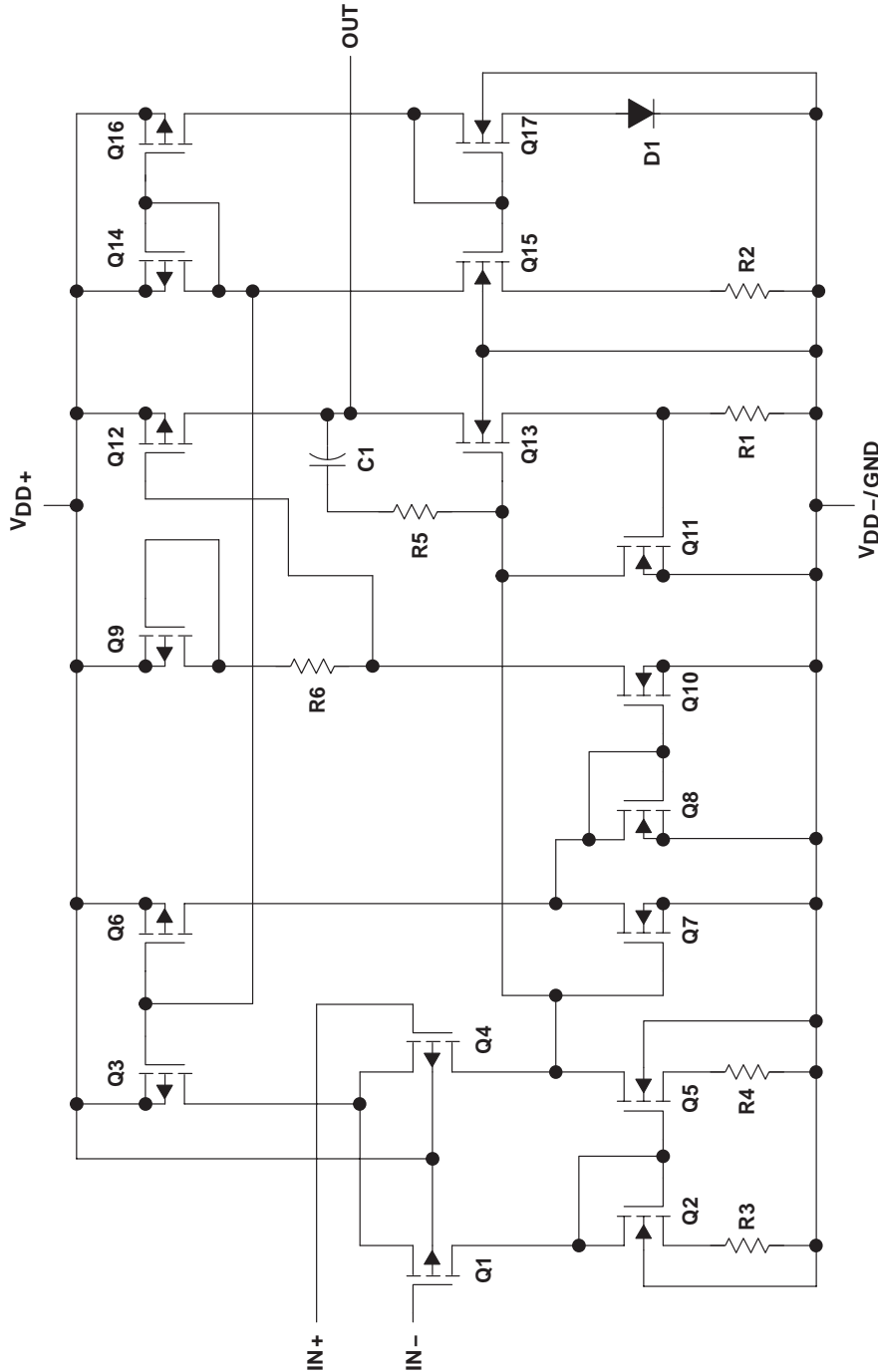
**TLV2254, TLV2254A**  
**D PACKAGE**  
**(TOP VIEW)**



**TLV2254, TLV2254A**  
**PW PACKAGE**  
**(TOP VIEW)**



equivalent schematic (each amplifier)



ACTUAL DEVICE COMPONENT COUNT†		
COMPONENT	TLV2252	TLV2254
Transistors	38	76
Resistors	30	56
Diodes	9	18
Capacitors	3	6

† Includes both amplifiers and all ESD, bias, and trim circuitry

**TLV225x-Q1, TLV225xA-Q1**  
**Advanced LinCMOS™ RAIL-TO-RAIL**  
**VERY LOW-POWER OPERATIONAL AMPLIFIERS**

SGLS192A – OCTOBER 2003 – REVISED MARCH 2004

**absolute maximum ratings over operating free-air temperature range (unless otherwise noted)†**

Supply voltage, $V_{DD}$ (see Note 1)	16 V
Differential input voltage, $V_{ID}$ (see Note 2)	$\pm V_{DD}$
Input voltage range, $V_I$ (any input, see Note 1)	$V_{DD-} - 0.3 \text{ V to } V_{DD+}$
Input current, $I_I$ (each input)	$\pm 5 \text{ mA}$
Output current, $I_O$	$\pm 50 \text{ mA}$
Total current into $V_{DD+}$	$\pm 50 \text{ mA}$
Total current out of $V_{DD-}$	$\pm 50 \text{ mA}$
Duration of short-circuit current (at or below) 25°C (see Note 3)	unlimited
Continuous total power dissipation	See Dissipation Rating Table
Operating free-air temperature range, $T_A$ : Q Suffix	-40°C to 125°C
Storage temperature range, $T_{stg}$	-65°C to 150°C
Lead temperature 1,6 mm (1/16 inch) from case for 10 seconds: D and PW packages	260°C

† Stresses beyond those listed under “absolute maximum ratings” may cause permanent damage to the device. These are stress ratings only, and functional operation of the device at these or any other conditions beyond those indicated under “recommended operating conditions” is not implied. Exposure to absolute-maximum-rated conditions for extended periods may affect device reliability.

- NOTES: 1. All voltage values, except differential voltages, are with respect to  $V_{DD-}$ .
2. Differential voltages are at the noninverting input with respect to the inverting input. Excessive current flows when input is brought below  $V_{DD-} - 0.3 \text{ V}$ .
3. The output may be shorted to either supply. Temperature and/or supply voltages must be limited to ensure that the maximum dissipation rating is not exceeded.

**DISSIPATION RATING TABLE**

PACKAGE	$T_A \leq 25^\circ\text{C}$ POWER RATING	DERATING FACTOR ABOVE $T_A = 25^\circ\text{C}$	$T_A = 85^\circ\text{C}$ POWER RATING	$T_A = 125^\circ\text{C}$ POWER RATING
D-8	725 mW	5.8 mW/°C	377 mW	145 mW
D-14	950 mW	7.6 mW/°C	494 mW	190 mW
PW-8	525 mW	4.2 mW/°C	273 mW	105 mW
PW-14	700 mW	5.6 mW/°C	364 mW	140 mW

**recommended operating conditions**

	MIN	MAX	UNIT
Supply voltage, $V_{DD}$ (see Note 1)	2.7	16	V
Input voltage range, $V_I$	$V_{DD-}$	$V_{DD+} - 1.3$	V
Common-mode input voltage, $V_{IC}$	$V_{DD-}$	$V_{DD+} - 1.3$	V
Operating free-air temperature, $T_A$	-40	125	°C

NOTE 1: All voltage values, except differential voltages, are with respect to  $V_{DD-}$ .



**TLV225x-Q1, TLV225xA-Q1**  
**Advanced LinCMOS™ RAIL-TO-RAIL**  
**VERY LOW-POWER OPERATIONAL AMPLIFIERS**

SGLS192A – OCTOBER 2003 – REVISED MARCH 2004

**TLV2252-Q1 electrical characteristics at specified free-air temperature,  $V_{DD} = 3\text{ V}$  (unless otherwise noted)**

PARAMETER	TEST CONDITIONS	$T_A$ †	TLV2252-Q1			TLV2252A-Q1			UNIT
			MIN	TYP	MAX	MIN	TYP	MAX	
$V_{IO}$ Input offset voltage	$V_{DD\pm} = \pm 1.5\text{ V}$ , $V_O = 0$ , $V_{IC} = 0$ , $R_S = 50\ \Omega$	25°C		200	1500		200	850	$\mu\text{V}$
		Full range			1750		1000		
$\alpha_{VIO}$ Temperature coefficient of input offset voltage		25°C to 85°C		0.5			0.5		$\mu\text{V}/^\circ\text{C}$
Input offset voltage long-term drift (see Note 4)		25°C		0.003			0.003		$\mu\text{V}/\text{mo}$
$I_{IO}$ Input offset current		25°C		0.5	60		0.5	60	$\text{pA}$
		125°C			1000			1000	
$I_{IB}$ Input bias current	25°C			1	60		1	60	$\text{pA}$
	125°C				1000			1000	
$V_{ICR}$ Common-mode input voltage range	$R_S = 50\ \Omega$ , $ V_{IO}  \leq 5\text{ mV}$	25°C	0 to 2	-0.3 to 2.2		0 to 2	-0.3 to 2.2	$\text{V}$	
		Full range	0 to 1.7			0 to 1.7			
$V_{OH}$ High-level output voltage	$I_{OH} = -20\ \mu\text{A}$	25°C		2.98			2.98	$\text{V}$	
	$I_{OH} = -75\ \mu\text{A}$	25°C		2.9			2.9		
	$I_{OH} = -150\ \mu\text{A}$	Full range		2.8			2.8		
$V_{OL}$ Low-level output voltage	$V_{IC} = 1.5\text{ V}$ , $I_{OL} = 50\ \mu\text{A}$	25°C		10			10	$\text{mV}$	
	$V_{IC} = 1.5\text{ V}$ , $I_{OL} = 500\ \mu\text{A}$	25°C		100	150		100		150
	$V_{IC} = 1.5\text{ V}$ , $I_{OL} = 1\text{ mA}$	Full range			165				165
		25°C			200	300			200
	Full range				300				300
$A_{VD}$ Large-signal differential voltage amplification	$V_{IC} = 1.5\text{ V}$ , $V_O = 1\text{ V to }2\text{ V}$	$R_L = 100\ \text{k}\Omega$ ‡	25°C	100	250		100	250	$\text{V/mV}$
			Full range		10			10	
		$R_L = 1\ \text{M}\Omega$ ‡	25°C		800			800	
$r_{i(d)}$ Differential input resistance		25°C		$10^{12}$			$10^{12}$	$\Omega$	
$r_{i(c)}$ Common-mode input resistance		25°C		$10^{12}$			$10^{12}$	$\Omega$	
$C_{i(c)}$ Common-mode input capacitance	$f = 10\ \text{kHz}$	25°C		8			8	$\text{pF}$	
$z_o$ Closed-loop output impedance	$f = 25\ \text{kHz}$ , $A_V = 10$	25°C		220			220	$\Omega$	
CMRR Common-mode rejection ratio	$V_{IC} = 0\text{ to }1.7\text{ V}$ , $V_O = 1.5\text{ V}$ , $R_S = 50\ \Omega$	25°C	65	75		65	77	$\text{dB}$	
		Full range		60			60		
$k_{SVR}$ Supply voltage rejection ratio ( $\Delta V_{DD} / \Delta V_{IO}$ )	$V_{DD} = 2.7\text{ V to }8\text{ V}$ , $V_{IC} = V_{DD}/2$ , No load	25°C	80	95		80	100	$\text{dB}$	
		Full range		80			80		
$I_{DD}$ Supply current	$V_O = 1.5\text{ V}$ , No load	25°C		68	125		68	125	$\mu\text{A}$
		Full range			150			150	

† Full range is  $-40^\circ\text{C}$  to  $125^\circ\text{C}$  for Q level part.

‡ Referenced to 1.5 V

NOTE 4: Typical values are based on the input offset voltage shift observed through 500 hours of operating life test at  $T_A = 150^\circ\text{C}$  extrapolated to  $T_A = 25^\circ\text{C}$  using the Arrhenius equation and assuming an activation energy of 0.96 eV.



**TLV225x-Q1, TLV225xA-Q1**  
**Advanced LinCMOS™ RAIL-TO-RAIL**  
**VERY LOW-POWER OPERATIONAL AMPLIFIERS**

SGLS192A – OCTOBER 2003 – REVISED MARCH 2004

**TLV2252-Q1 operating characteristics at specified free-air temperature,  $V_{DD} = 3\text{ V}$**

PARAMETER	TEST CONDITIONS	$T_A$ †	TLV2252-Q1			TLV2252A-Q1			UNIT
			MIN	TYP	MAX	MIN	TYP	MAX	
SR	Slew rate at unity gain $V_O = 0.8\text{ V to }1.4\text{ V}$ , $R_L = 100\text{ k}\Omega$ ‡, $C_L = 100\text{ pF}$ ‡	25°C	0.07	0.1		0.07	0.1	V/ $\mu\text{s}$	
		Full range	0.05			0.05			
$V_n$	Equivalent input noise voltage $f = 10\text{ Hz}$ $f = 1\text{ kHz}$	25°C	35			35			nV/ $\sqrt{\text{Hz}}$
		25°C	19			19			
$V_{N(PP)}$	Peak-to-peak equivalent input noise voltage $f = 0.1\text{ Hz to }1\text{ Hz}$ $f = 0.1\text{ Hz to }10\text{ Hz}$	25°C	0.6			0.6			$\mu\text{V}$
		25°C	1.1			1.1			
$I_n$	Equivalent input noise current	25°C	0.6			0.6			fA/ $\sqrt{\text{Hz}}$
	Gain-bandwidth product $f = 1\text{ kHz}$ , $R_L = 50\text{ k}\Omega$ ‡, $C_L = 100\text{ pF}$ ‡	25°C	0.187			0.187			MHz
BOM	Maximum output-swing bandwidth $V_{O(PP)} = 1\text{ V}$ , $R_L = 50\text{ k}\Omega$ ‡, $A_V = 1$ , $C_L = 100\text{ pF}$ ‡	25°C	60			60			kHz
$\phi_m$	Phase margin at unity gain $R_L = 50\text{ k}\Omega$ ‡, $C_L = 100\text{ pF}$ ‡	25°C	63°			63°			
		25°C	15			15			dB

† Full range is  $-40^\circ\text{C}$  to  $125^\circ\text{C}$  for Q level part.

‡ Referenced to 1.5 V



**TLV225x-Q1, TLV225xA-Q1**  
**Advanced LinCMOS™ RAIL-TO-RAIL**  
**VERY LOW-POWER OPERATIONAL AMPLIFIERS**

SGLS192A – OCTOBER 2003 – REVISED MARCH 2004

**TLV2252-Q1 electrical characteristics at specified free-air temperature,  $V_{DD} = 5\text{ V}$  (unless otherwise noted)**

PARAMETER	TEST CONDITIONS	$T_A$ †	TLV2252-Q1			TLV2252A-Q1			UNIT
			MIN	TYP	MAX	MIN	TYP	MAX	
$V_{IO}$ Input offset voltage	$V_{DD\pm} = \pm 2.5\text{ V}$ , $V_O = 0$ , $V_{IC} = 0$ , $R_S = 50\ \Omega$	25°C	200	1500		200	850	$\mu\text{V}$	
		Full range			1750		1000		
$\alpha_{VIO}$ Temperature coefficient of input offset voltage		25°C to 85°C	0.5			0.5		$\mu\text{V}/^\circ\text{C}$	
Input offset voltage long-term drift (see Note 4)		25°C	0.003			0.003		$\mu\text{V}/\text{mo}$	
$I_{IO}$ Input offset current		25°C	0.5	60		0.5	60	$\text{pA}$	
		125°C			1000		1000		
$I_{IB}$ Input bias current	25°C	1	60		1	60	$\text{pA}$		
	125°C			1000		1000			
$V_{ICR}$ Common-mode input voltage range	$ V_{IO}  \leq 5\text{ mV}$ , $R_S = 50\ \Omega$	25°C	0 to 4	-0.3 to 4.2		0 to 4	-0.3 to 4.2	$\text{V}$	
		Full range	0 to 3.5			0 to 3.5			
$V_{OH}$ High-level output voltage	$I_{OH} = -20\ \mu\text{A}$ $I_{OH} = -75\ \mu\text{A}$ $I_{OH} = -150\ \mu\text{A}$	25°C	4.98			4.98		$\text{V}$	
		25°C	4.9	4.94		4.9	4.94		
		Full range	4.8			4.8			
		25°C	4.8	4.88		4.8	4.88		
$V_{OL}$ Low-level output voltage	$V_{IC} = 2.5\text{ V}$ , $I_{OL} = 50\ \mu\text{A}$ $I_{OL} = 500\ \mu\text{A}$ $I_{OL} = 1\text{ mA}$	25°C	0.01			0.01		$\text{V}$	
		25°C	0.09	0.15		0.09	0.15		
		Full range			0.15		0.15		
		25°C	0.2	0.3		0.2	0.3		
		Full range			0.3		0.3		
$A_{VD}$ Large-signal differential voltage amplification	$V_{IC} = 2.5\text{ V}$ , $V_O = 1\text{ V to }4\text{ V}$	$R_L = 100\text{ k}\Omega$ †	25°C	100	350		100	350	$\text{V}/\text{mV}$
			Full range	10			10		
		$R_L = 1\text{ M}\Omega$ ‡	25°C		1700			1700	
$r_{i(d)}$ Differential input resistance		25°C		$10^{12}$			$10^{12}$	$\Omega$	
$r_{i(c)}$ Common-mode input resistance		25°C		$10^{12}$			$10^{12}$	$\Omega$	
$c_{i(c)}$ Common-mode input capacitance	$f = 10\text{ kHz}$	25°C		8			8	$\text{pF}$	
$z_o$ Closed-loop output impedance	$f = 25\text{ kHz}$ , $A_V = 10$	25°C		200			200	$\Omega$	
CMRR Common-mode rejection ratio	$V_{IC} = 0\text{ to }2.7\text{ V}$ , $V_O = 2.5\text{ V}$ , $R_S = 50\ \Omega$	25°C	70	83		70	83	$\text{dB}$	
		Full range	70			70			
$k_{SVR}$ Supply voltage rejection ratio ( $\Delta V_{DD}/\Delta V_{IO}$ )	$V_{DD} = 4.4\text{ V to }8\text{ V}$ , $V_{IC} = V_{DD}/2$ , No load	25°C	80	95		80	95	$\text{dB}$	
		Full range	80			80			

† Full range is  $-40^\circ\text{C}$  to  $125^\circ\text{C}$  for Q level part.

‡ Referenced to 2.5 V

NOTE 4: Typical values are based on the input offset voltage shift observed through 500 hours of operating life test at  $T_A = 150^\circ\text{C}$  extrapolated to  $T_A = 25^\circ\text{C}$  using the Arrhenius equation and assuming an activation energy of 0.96 eV.



**TLV225x-Q1, TLV225xA-Q1**  
**Advanced LinCMOS™ RAIL-TO-RAIL**  
**VERY LOW-POWER OPERATIONAL AMPLIFIERS**

SGLS192A – OCTOBER 2003 – REVISED MARCH 2004

**TLV2252-Q1 electrical characteristics at specified free-air temperature,  $V_{DD} = 5\text{ V}$  (unless otherwise noted) (continued)**

PARAMETER	TEST CONDITIONS	$T_A$ †	TLV2252-Q1			TLV2252A-Q1			UNIT
			MIN	TYP	MAX	MIN	TYP	MAX	
$I_{DD}$ Supply current	$V_O = 2.5\text{ V}$ , No load	25°C	70	125		70	125	$\mu\text{A}$	
		Full range		150		150			

† Full range is  $-40^\circ\text{C}$  to  $125^\circ\text{C}$  for Q level part.

**TLV2252-Q1 operating characteristics at specified free-air temperature,  $V_{DD} = 5\text{ V}$**

PARAMETER	TEST CONDITIONS	$T_A$ †	TLV2252-Q1			TLV2252A-Q1			UNIT
			MIN	TYP	MAX	MIN	TYP	MAX	
SR Slew rate at unity gain	$V_O = 1.25\text{ V}$ to $2.75\text{ V}$ , $R_L = 100\text{ k}\Omega$ ‡, $C_L = 100\text{ pF}$ ‡	25°C	0.07	0.12		0.07	0.12	$\text{V}/\mu\text{s}$	
		Full range	0.05			0.05			
$V_n$ Equivalent input noise voltage	$f = 10\text{ Hz}$	25°C		36			36	$\text{nV}/\sqrt{\text{Hz}}$	
	$f = 1\text{ kHz}$	25°C		19			19		
$V_{N(PP)}$ Peak-to-peak equivalent input noise voltage	$f = 0.1\text{ Hz}$ to $1\text{ Hz}$	25°C		0.7			0.7	$\mu\text{V}$	
	$f = 0.1\text{ Hz}$ to $10\text{ Hz}$	25°C		1.1			1.1		
$I_n$ Equivalent input noise current		25°C		0.6			0.6	$\text{fA}/\sqrt{\text{Hz}}$	
THD + N Total harmonic distortion plus noise	$V_O = 0.5\text{ V}$ to $2.5\text{ V}$ , $f = 20\text{ kHz}$ , $R_L = 50\text{ k}\Omega$ ‡	25°C		$A_V = 1$	0.2%		0.2%		
				$A_V = 10$	1%		1%		
Gain-bandwidth product	$f = 50\text{ kHz}$ , $C_L = 100\text{ pF}$ ‡	25°C		0.2			0.2	MHz	
BOM Maximum output-swing bandwidth	$V_{O(PP)} = 2\text{ V}$ , $R_L = 50\text{ k}\Omega$ ‡	25°C		30			30	kHz	
$\phi_m$ Phase margin at unity gain	$R_L = 50\text{ k}\Omega$ ‡, $C_L = 100\text{ pF}$ ‡	25°C		63°			63°		
		25°C		15			15	dB	
Gain margin		25°C		15			15	dB	

† Full range is  $-40^\circ\text{C}$  to  $125^\circ\text{C}$  for Q level part.

‡ Referenced to  $2.5\text{ V}$



**TLV225x-Q1, TLV225xA-Q1**  
**Advanced LinCMOS™ RAIL-TO-RAIL**  
**VERY LOW-POWER OPERATIONAL AMPLIFIERS**

SGLS192A – OCTOBER 2003 – REVISED MARCH 2004

**TLV2254-Q1 electrical characteristics at specified free-air temperature,  $V_{DD} = 3\text{ V}$  (unless otherwise noted)**

PARAMETER	TEST CONDITIONS	$T_A$ †	TLV2254-Q1			TLV2254A-Q1			UNIT		
			MIN	TYP	MAX	MIN	TYP	MAX			
$V_{IO}$ Input offset voltage		25°C	200	1500		200	850	$\mu\text{V}$			
		Full range			1750		1000				
$\alpha_{VIO}$ Temperature coefficient of input offset voltage		25°C to 125°C	0.5			0.5			$\mu\text{V}/^\circ\text{C}$		
Input offset voltage long-term drift (see Note 4)	$V_{DD} \pm \pm 1.5\text{ V}$ , $V_O = 0$ ,	25°C	0.003			0.003			$\mu\text{V}/\text{mo}$		
$I_{IO}$ Input offset current		25°C	0.5	60		0.5	60	$\text{pA}$			
		125°C			1000		1000				
$I_{IB}$ Input bias current		25°C	1	60		1	60	$\text{pA}$			
		125°C			1000		1000				
$V_{ICR}$ Common-mode input voltage range	$R_S = 50\ \Omega$ , $ V_{IO}  \leq 5\text{ mV}$	25°C	0 to 2	-0.3 to 2.2		0 to 2	-0.3 to 2.2	$\text{V}$			
		Full range	0 to 1.7			0 to 1.7					
$V_{OH}$ High-level output voltage	$I_{OH} = -20\ \mu\text{A}$	25°C	2.98			2.98			$\text{V}$		
	$I_{OH} = -75\ \mu\text{A}$	25°C	2.9			2.9					
	Full range		2.8			2.8					
$V_{OL}$ Low-level output voltage	$V_{IC} = 1.5\text{ V}$ , $I_{OL} = 50\ \mu\text{A}$	25°C	10			10			$\text{mV}$		
	$V_{IC} = 1.5\text{ V}$ , $I_{OL} = 500\ \mu\text{A}$	25°C	100	150		100	150				
	$V_{IC} = 1.5\text{ V}$ , $I_{OL} = 1\text{ mA}$	Full range		165			165				
		Full range		200	300		200	300			
$A_{VD}$ Large-signal differential voltage amplification	$V_{IC} = 1.5\text{ V}$ , $V_O = 1\text{ V to }2\text{ V}$	$R_L = 100\text{ k}\Omega$ ‡	25°C	100	225		100	225	$\text{V}/\text{mV}$		
		$R_L = 1\text{ M}\Omega$ ‡	Full range		10			10			
			25°C	800			800				
$r_{i(d)}$ Differential input resistance		25°C	$10^{12}$			$10^{12}$			$\Omega$		
$r_{i(c)}$ Common-mode input resistance		25°C	$10^{12}$			$10^{12}$			$\Omega$		
$c_{i(c)}$ Common-mode input capacitance	$f = 10\text{ kHz}$	25°C	8			8			$\text{pF}$		
$z_o$ Closed-loop output impedance	$f = 25\text{ kHz}$ , $A_V = 10$	25°C	220			220			$\Omega$		
CMRR Common-mode rejection ratio	$V_{IC} = 0\text{ to }1.7\text{ V}$ , $V_O = 1.5\text{ V}$ , $R_S = 50\ \Omega$	25°C	65	75		65	77	$\text{dB}$			
		Full range	60			60					
$k_{SVR}$ Supply voltage rejection ratio ( $\Delta V_{DD}/\Delta V_{IO}$ )	$V_{DD} = 2.7\text{ V to }8\text{ V}$ , $V_{IC} = V_{DD}/2$ , No load	25°C	80	95		80	100	$\text{dB}$			
		Full range	80			80					

† Full range is  $-40^\circ\text{C}$  to  $125^\circ\text{C}$  for Q level part.

‡ Referenced to 1.5 V

NOTE 4: Typical values are based on the input offset voltage shift observed through 500 hours of operating life test at  $T_A = 150^\circ\text{C}$  extrapolated to  $T_A = 25^\circ\text{C}$  using the Arrhenius equation and assuming an activation energy of 0.96 eV.



**TLV225x-Q1, TLV225xA-Q1**  
**Advanced LinCMOS™ RAIL-TO-RAIL**  
**VERY LOW-POWER OPERATIONAL AMPLIFIERS**

SGLS192A – OCTOBER 2003 – REVISED MARCH 2004

**TLV2254-Q1 electrical characteristics at specified free-air temperature,  $V_{DD} = 3\text{ V}$  (unless otherwise noted) (continued)**

PARAMETER	TEST CONDITIONS	$T_A$ †	TLV2254-Q1			TLV2254A-Q1			UNIT
			MIN	TYP	MAX	MIN	TYP	MAX	
$I_{DD}$	Supply current (four amplifiers)	$V_O = 1.5\text{ V}$ , No load	25°C	135	250	135	250	$\mu\text{A}$	
			Full range	300			300		

† Full range is  $-40^\circ\text{C}$  to  $125^\circ\text{C}$  for Q level part.

**TLV2254-Q1 operating characteristics at specified free-air temperature,  $V_{DD} = 3\text{ V}$**

PARAMETER	TEST CONDITIONS	$T_A$ †	TLV2254-Q1			TLV2254A-Q1			UNIT
			MIN	TYP	MAX	MIN	TYP	MAX	
SR	Slew rate at unity gain	$V_O = 0.5\text{ V}$ to $1.7\text{ V}$ , $R_L = 100\text{ k}\Omega$ ‡, $C_L = 100\text{ pF}$ ‡	25°C	0.07	0.1	0.07	0.1	$\text{V}/\mu\text{s}$	
			Full range	0.05			0.05		
$V_n$	Equivalent input noise voltage	$f = 10\text{ Hz}$	25°C	35			35	$\text{nV}/\sqrt{\text{Hz}}$	
			$f = 1\text{ kHz}$	19			19		
$V_{N(PP)}$	Peak-to-peak equivalent input noise voltage	$f = 0.1\text{ Hz}$ to $1\text{ Hz}$	25°C	0.6			0.6	$\mu\text{V}$	
			$f = 0.1\text{ Hz}$ to $10\text{ Hz}$	1.1			1.1		
$I_n$	Equivalent input noise current	$f = 1\text{ kHz}$ , $R_L = 50\text{ k}\Omega$ ‡, $C_L = 100\text{ pF}$ ‡	25°C	0.6			0.6	$\text{fA}/\sqrt{\text{Hz}}$	
BOM	Maximum output-swing bandwidth	$V_{O(PP)} = 1\text{ V}$ , $A_V = 1$ , $R_L = 50\text{ k}\Omega$ ‡, $C_L = 100\text{ pF}$ ‡	25°C	60			60	kHz	
			25°C	15			15		
$\phi_m$	Phase margin at unity gain	$R_L = 50\text{ k}\Omega$ ‡, $C_L = 100\text{ pF}$ ‡	25°C	63°			63°	dB	
			25°C	15			15		

† Full range is  $-40^\circ\text{C}$  to  $125^\circ\text{C}$  for Q level part.

‡ Referenced to  $1.5\text{ V}$



**TLV225x-Q1, TLV225xA-Q1**  
**Advanced LinCMOS™ RAIL-TO-RAIL**  
**VERY LOW-POWER OPERATIONAL AMPLIFIERS**

SGLS192A – OCTOBER 2003 – REVISED MARCH 2004

**TLV2254-Q1 electrical characteristics at specified free-air temperature,  $V_{DD} = 5\text{ V}$  (unless otherwise noted)**

PARAMETER	TEST CONDITIONS	$T_A$ †	TLV2254-Q1			TLV2254A-Q1			UNIT
			MIN	TYP	MAX	MIN	TYP	MAX	
$V_{IO}$ Input offset voltage		25°C	200		1500	200		850	$\mu\text{V}$
		Full range	1750			1000			
$\alpha_{VIO}$ Temperature coefficient of input offset voltage		25°C to 125°C	0.5			0.5			$\mu\text{V}/^\circ\text{C}$
Input offset voltage long-term drift (see Note 4)	$V_{DD\pm} = \pm 2.5\text{ V}$ , $V_{IC} = 0$ , $V_O = 0$ , $R_S = 50\ \Omega$	25°C	0.003			0.003			$\mu\text{V}/\text{mo}$
$I_{IO}$ Input offset current		25°C	0.5		60	0.5		60	$\text{pA}$
		125°C	1000			1000			
$I_{IB}$ Input bias current		25°C	1		60	1		60	$\text{pA}$
	125°C	1000			1000				
$V_{ICR}$ Common-mode input voltage range	$ V_{IO}  \leq 5\text{ mV}$ , $R_S = 50\ \Omega$	25°C	0 to 4	-0.3 to 4.2	0 to 4	-0.3 to 4.2	$\text{V}$		
		Full range	0 to 3.5		0 to 3.5				
$V_{OH}$ High-level output voltage	$I_{OH} = -20\ \mu\text{A}$	25°C	4.98		4.98		$\text{V}$		
	$I_{OH} = -75\ \mu\text{A}$	25°C	4.9	4.94	4.9	4.94			
	$I_{OH} = -150\ \mu\text{A}$	Full range	4.8		4.8				
		25°C	4.8	4.88	4.8	4.88			
$V_{OL}$ Low-level output voltage	$V_{IC} = 2.5\text{ V}$ , $I_{OL} = 50\ \mu\text{A}$	25°C	0.01		0.01		$\text{V}$		
		25°C	0.09	0.15	0.09	0.15			
	$V_{IC} = 2.5\text{ V}$ , $I_{OL} = 500\ \mu\text{A}$	Full range	0.15		0.15				
		25°C	0.2	0.3	0.2	0.3			
	$V_{IC} = 2.5\text{ V}$ , $I_{OL} = 1\text{ mA}$	Full range	0.3		0.3				
		25°C	100	350	100	350			
$A_{VD}$ Large-signal differential voltage amplification	$V_{IC} = 2.5\text{ V}$ , $V_O = 1\text{ V to }4\text{ V}$	$R_L = 100\text{ k}\Omega$ ‡	10		10		$\text{V/mV}$		
		$R_L = 1\text{ M}\Omega$ ‡	25°C	1700		1700			
			Full range	10					10
$r_{i(d)}$ Differential input resistance		25°C	$10^{12}$			$10^{12}$			$\Omega$
$r_{i(c)}$ Common-mode input resistance		25°C	$10^{12}$			$10^{12}$			$\Omega$
$c_{i(c)}$ Common-mode input capacitance	$f = 10\text{ kHz}$	25°C	8			8			$\text{pF}$
$z_o$ Closed-loop output impedance	$f = 25\text{ kHz}$ , $A_V = 10$	25°C	200			200			$\Omega$
CMRR Common-mode rejection ratio	$V_{IC} = 0\text{ to }2.7\text{ V}$ , $V_O = 2.5\text{ V}$ , $R_S = 50\ \Omega$	25°C	70	83	70	83	$\text{dB}$		
		Full range	70			70			
$k_{SVR}$ Supply voltage rejection ratio ( $\Delta V_{DD}/\Delta V_{IO}$ )	$V_{DD} = 4.4\text{ V to }8\text{ V}$ , $V_{IC} = V_{DD}/2$ , No load	25°C	80	95	80	95	$\text{dB}$		
		Full range	80			80			

† Full range is  $-40^\circ\text{C}$  to  $125^\circ\text{C}$  for Q level part.

‡ Referenced to 2.5 V

NOTE 4: Typical values are based on the input offset voltage shift observed through 500 hours of operating life test at  $T_A = 150^\circ\text{C}$  extrapolated to  $T_A = 25^\circ\text{C}$  using the Arrhenius equation and assuming an activation energy of 0.96 eV.



**TLV225x-Q1, TLV225xA-Q1**  
**Advanced LinCMOS™ RAIL-TO-RAIL**  
**VERY LOW-POWER OPERATIONAL AMPLIFIERS**

SGLS192A – OCTOBER 2003 – REVISED MARCH 2004

**TLV2254-Q1 electrical characteristics at specified free-air temperature,  $V_{DD} = 5\text{ V}$  (unless otherwise noted) (continued)**

PARAMETER	TEST CONDITIONS	$T_A$ †	TLV2254-Q1			TLV2254A-Q1			UNIT
			MIN	TYP	MAX	MIN	TYP	MAX	
$I_{DD}$	Supply current (four amplifiers)	$V_O = 2.5\text{ V}$ , No load	25°C	140	250	140	250	$\mu\text{A}$	
			Full range	300			300		

† Full range is  $-40^\circ\text{C}$  to  $125^\circ\text{C}$  for Q level part.

**TLV2254-Q1 operating characteristics at specified free-air temperature,  $V_{DD} = 5\text{ V}$**

PARAMETER	TEST CONDITIONS	$T_A$ †	TLV2254-Q1			TLV2254A-Q1			UNIT
			MIN	TYP	MAX	MIN	TYP	MAX	
SR	Slew rate at unity gain	$V_O = 0.5\text{ V to }3.5\text{ V}$ , $R_L = 100\text{ k}\Omega$ ‡, $C_L = 100\text{ pF}$ ‡	25°C	0.07	0.12	0.07	0.12	$\text{V}/\mu\text{s}$	
			Full range	0.05			0.05		
$V_n$	Equivalent input noise voltage	$f = 10\text{ Hz}$ $f = 1\text{ kHz}$	25°C	36			36	$\text{nV}/\sqrt{\text{Hz}}$	
			25°C	19			19		
$V_{N(PP)}$	Peak-to-peak equivalent input noise voltage	$f = 0.1\text{ Hz to }1\text{ Hz}$ $f = 0.1\text{ Hz to }10\text{ Hz}$	25°C	0.7			0.7	$\mu\text{V}$	
			25°C	1.1			1.1		
$I_n$	Equivalent input noise current		25°C	0.6			0.6	$\text{fA}/\sqrt{\text{Hz}}$	
THD + N	Total harmonic distortion plus noise	$V_O = 0.5\text{ V to }2.5\text{ V}$ , $f = 20\text{ kHz}$ , $R_L = 50\text{ k}\Omega$ ‡	25°C	$A_V = 1$			0.2%		
				$A_V = 10$			1%		
	Gain-bandwidth product	$f = 50\text{ kHz}$ , $C_L = 100\text{ pF}$ ‡	25°C	$R_L = 50\text{ k}\Omega$ ‡			0.2	MHz	
BOM	Maximum output-swing bandwidth	$V_{O(PP)} = 2\text{ V}$ , $R_L = 50\text{ k}\Omega$ ‡	25°C	$A_V = 1$ , $C_L = 100\text{ pF}$ ‡			30	kHz	
$\phi_m$	Phase margin at unity gain	$R_L = 50\text{ k}\Omega$ ‡, $C_L = 100\text{ pF}$ ‡	25°C				63°		
	Gain margin		25°C				15	dB	

† Full range is  $-40^\circ\text{C}$  to  $125^\circ\text{C}$  for Q level part.

‡ Referenced to 2.5 V



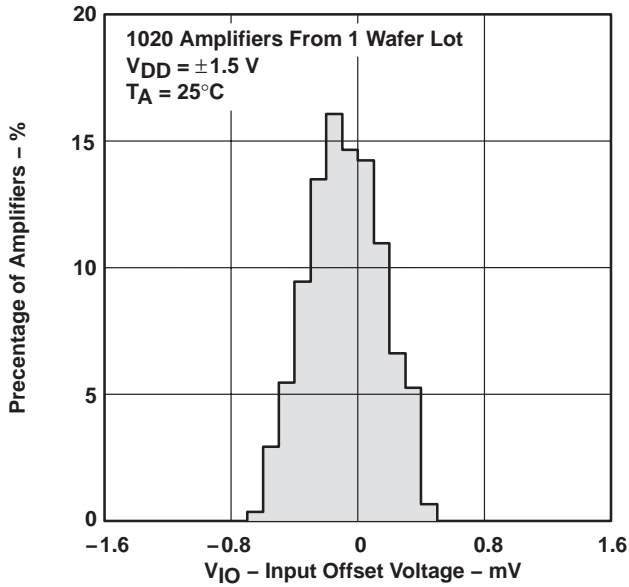
## TYPICAL CHARACTERISTICS

**Table of Graphs**

			FIGURE
$V_{IO}$	Input offset voltage	Distribution vs Common-mode voltage	2 – 5 6, 7
$\alpha_{VIO}$	Input offset voltage temperature coefficient	Distribution	8 – 11
$I_{IB}/I_{IO}$	Input bias and input offset currents	vs Free-air temperature	12
$V_I$	Input voltage	vs Supply voltage vs Free-air temperature	13 14
$V_{OH}$	High-level output voltage	vs High-level output current	15, 18
$V_{OL}$	Low-level output voltage	vs Low-level output current	16, 17, 19
$V_{O(PP)}$	Maximum peak-to-peak output voltage	vs Frequency	20
$I_{OS}$	Short-circuit output current	vs Supply voltage vs Free-air temperature	21 22
$V_{ID}$	Differential input voltage	vs Output voltage	23, 24
$A_{VD}$	Differential voltage amplification	vs Load resistance	25
$A_{VD}$	Large-signal differential voltage amplification	vs Frequency vs Free-air temperature	26, 27 28, 29
$z_o$	Output impedance	vs Frequency	30, 31
CMRR	Common-mode rejection ratio	vs Frequency vs Free-air temperature	32 33
$k_{SVR}$	Supply-voltage rejection ratio	vs Frequency vs Free-air temperature	34, 35 36
$I_{DD}$	Supply current	vs Supply voltage	37, 38
SR	Slew rate	vs Load capacitance vs Free-air temperature	39 40
$V_O$	Inverting large-signal pulse response		41, 42
$V_O$	Voltage-follower large-signal pulse response		43, 44
$V_O$	Inverting small-signal pulse response		45, 46
$V_O$	Voltage-follower small-signal pulse response		47, 48
$V_n$	Equivalent input noise voltage	vs Frequency	49, 50
	Input noise voltage	Over a 10-second period	51
	Integrated noise voltage	vs Frequency	52
THD + N	Total harmonic distortion plus noise	vs Frequency	53
	Gain-bandwidth product	vs Supply voltage vs Free-air temperature	54 55
$\phi_m$	Phase margin	vs Frequency vs Load capacitance	26, 27 56
	Gain margin	vs Load capacitance	57
$B_1$	Unity-gain bandwidth	vs Load capacitance	58
	Overestimation of phase margin	vs Load capacitance	59

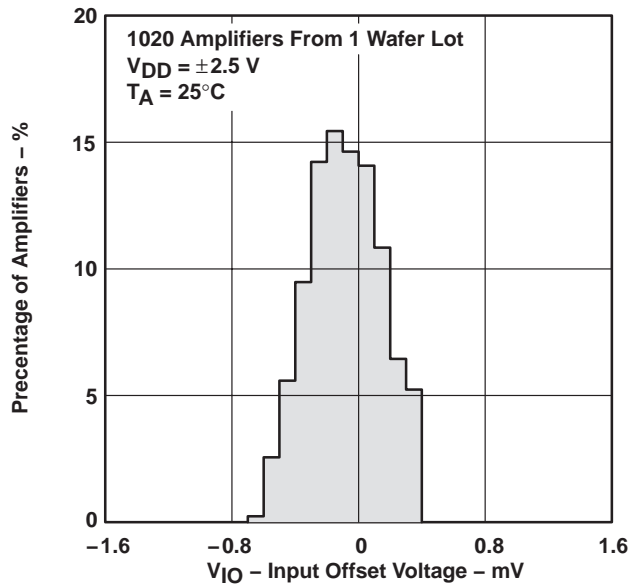
**TYPICAL CHARACTERISTICS**

**DISTRIBUTION OF TLV2252  
 INPUT OFFSET VOLTAGE**



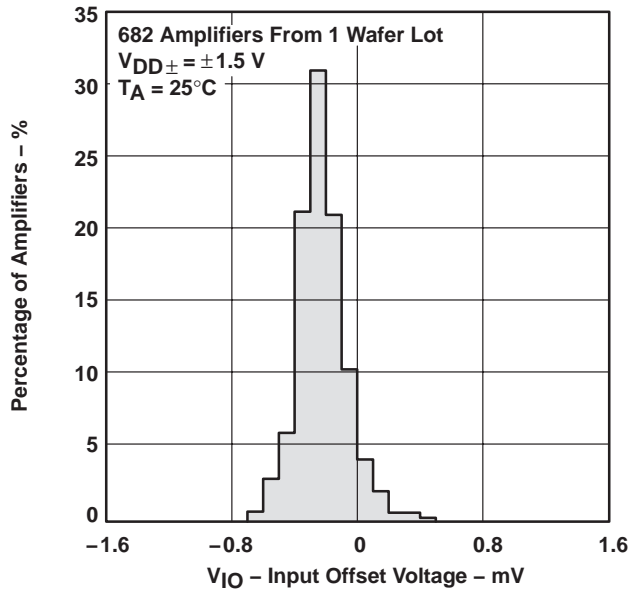
**Figure 2**

**DISTRIBUTION OF TLV2252  
 INPUT OFFSET VOLTAGE**



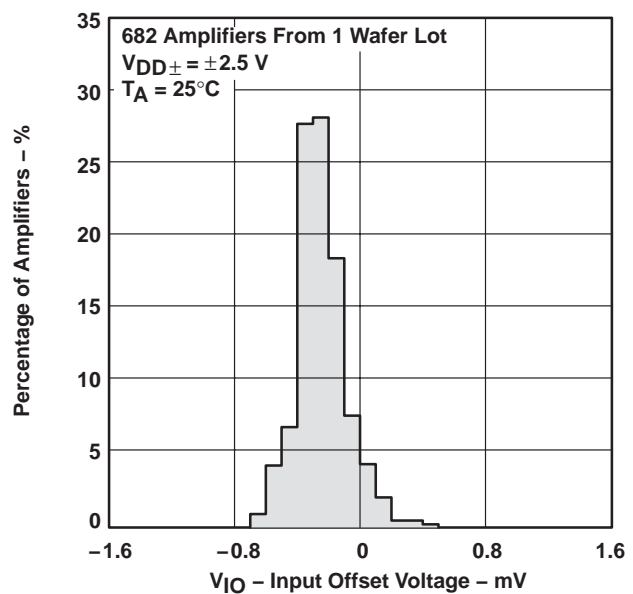
**Figure 3**

**DISTRIBUTION OF TLV2254  
 INPUT OFFSET VOLTAGE**



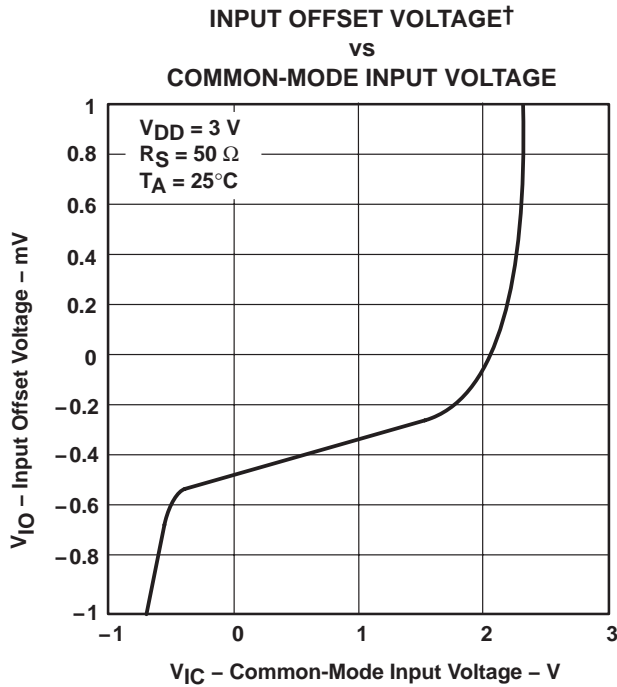
**Figure 4**

**DISTRIBUTION OF TLV2254  
 INPUT OFFSET VOLTAGE**

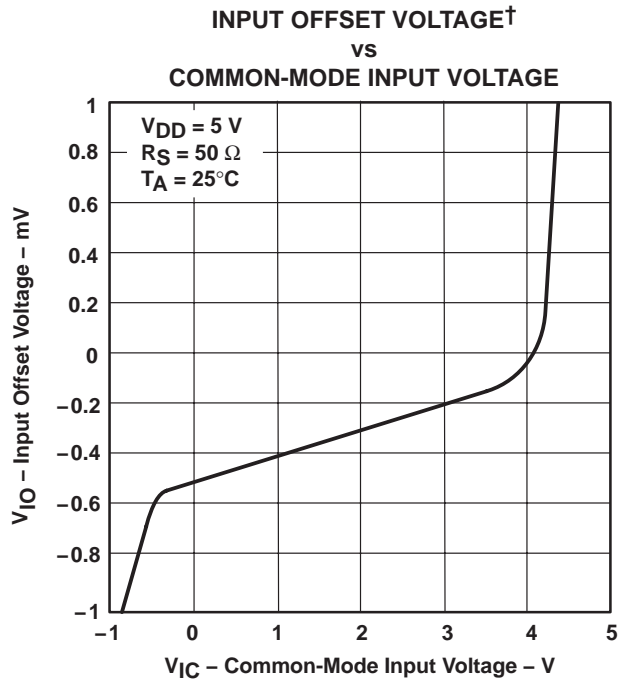


**Figure 5**

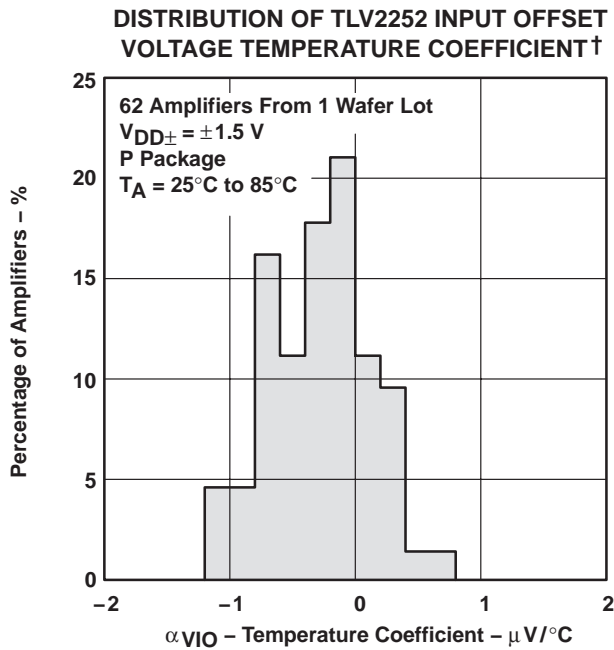
**TYPICAL CHARACTERISTICS**



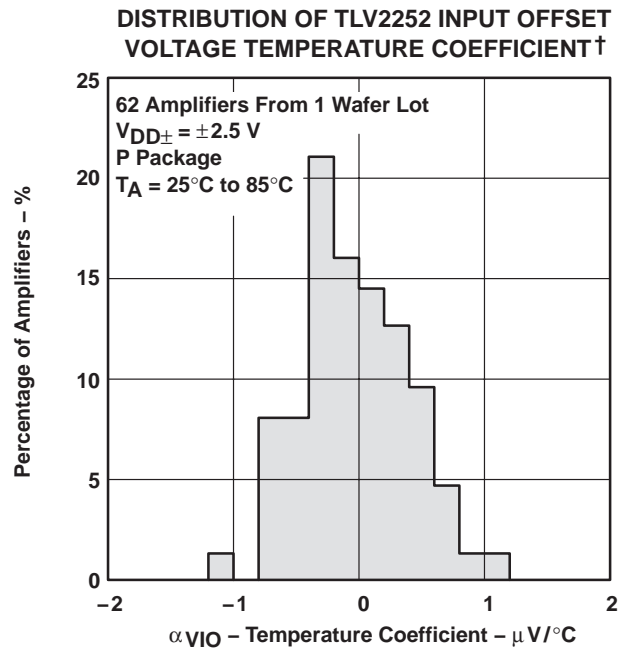
**Figure 6**



**Figure 7**



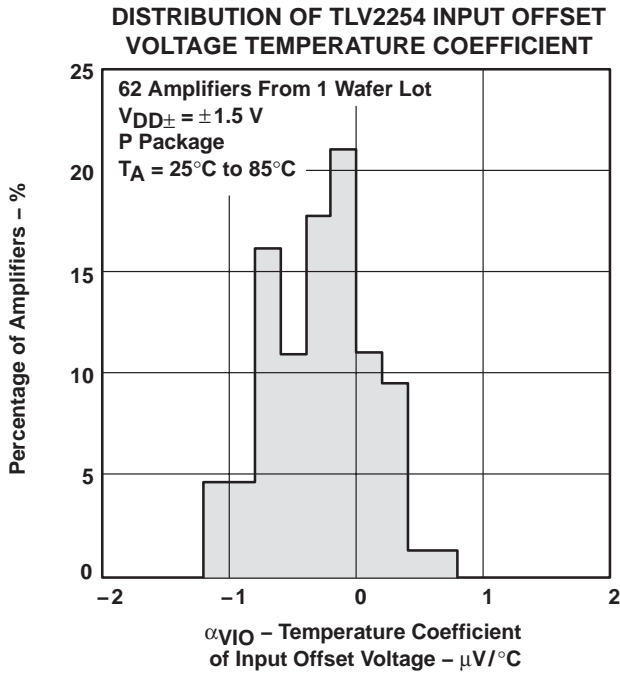
**Figure 8**



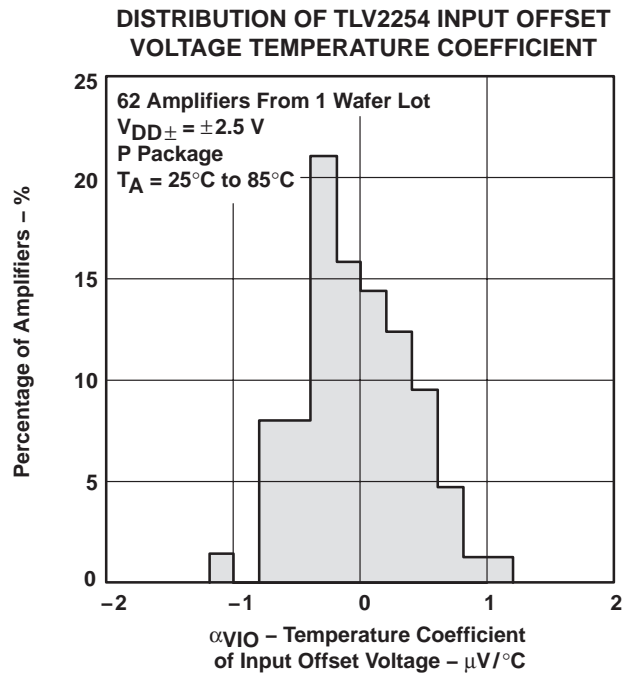
**Figure 9**

† For all curves where  $V_{DD} = 5\text{ V}$ , all loads are referenced to 2.5 V. For all curves where  $V_{DD} = 3\text{ V}$ , all loads are referenced to 1.5 V.

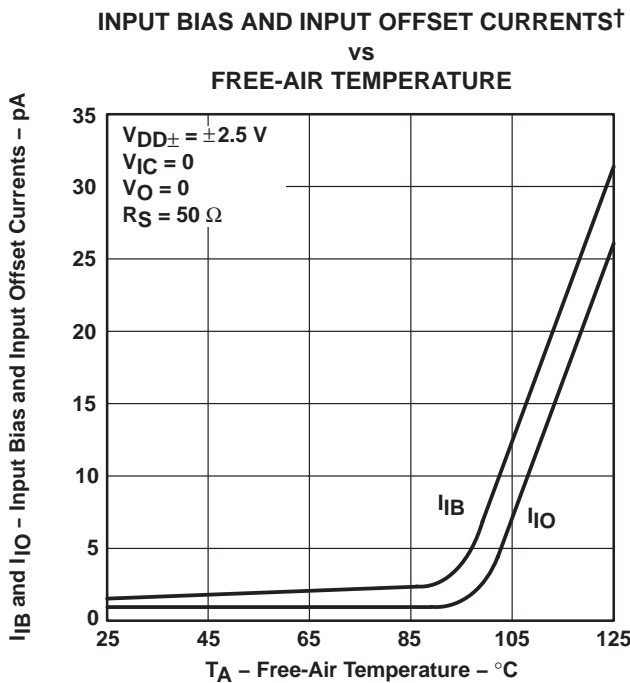
**TYPICAL CHARACTERISTICS**



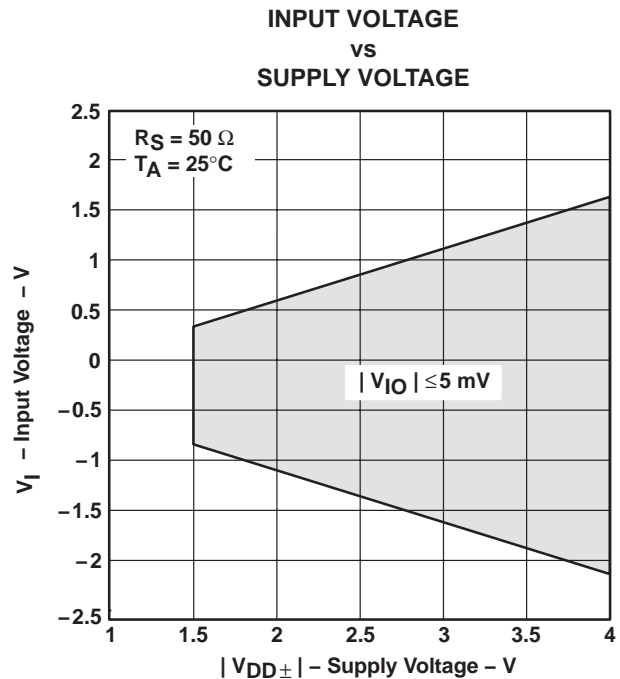
**Figure 10**



**Figure 11**



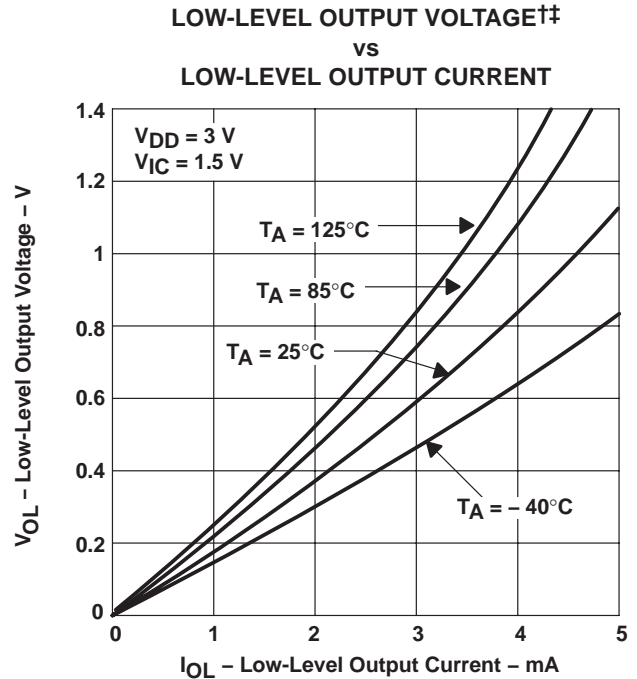
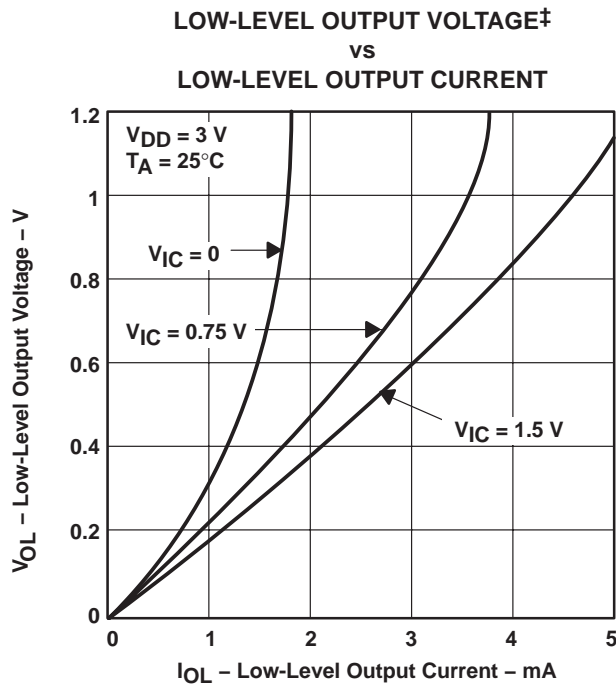
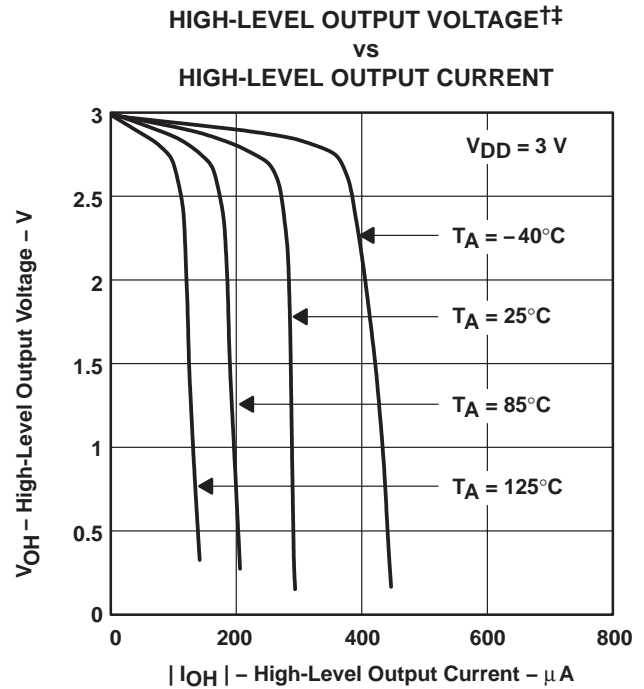
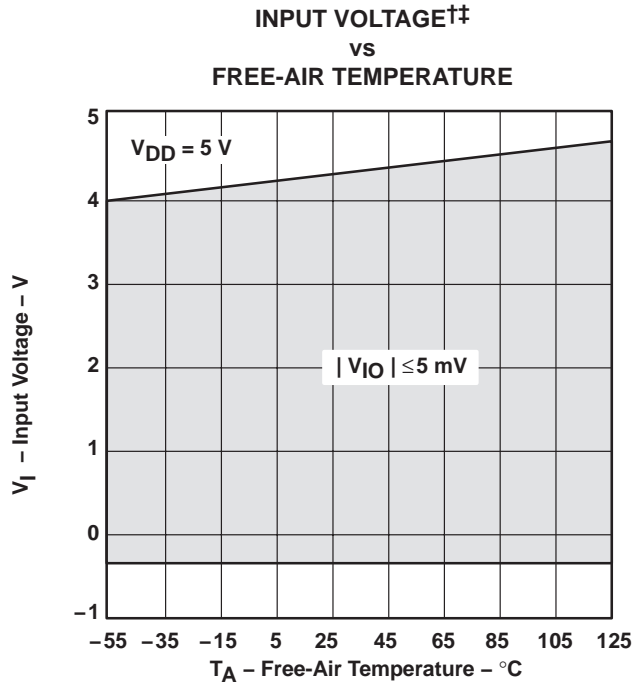
**Figure 12**



**Figure 13**

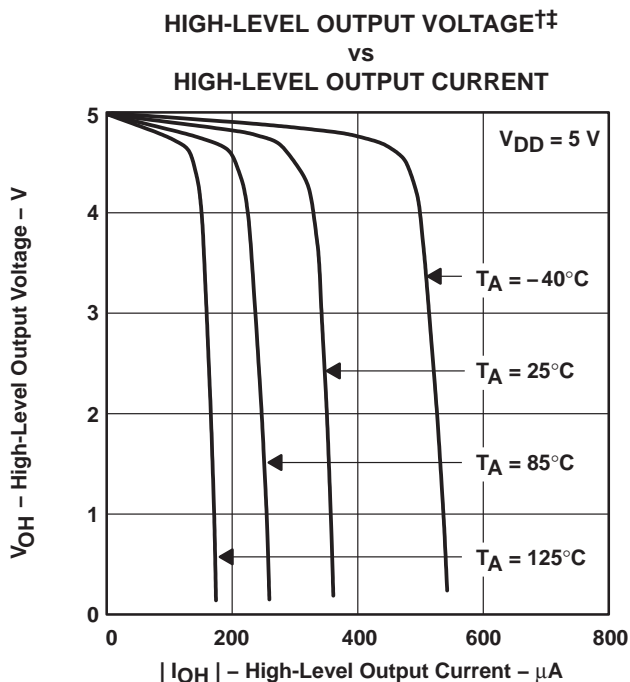
† Data at high and low temperatures are applicable only within the rated operating free-air temperature ranges of the various devices.

**TYPICAL CHARACTERISTICS**

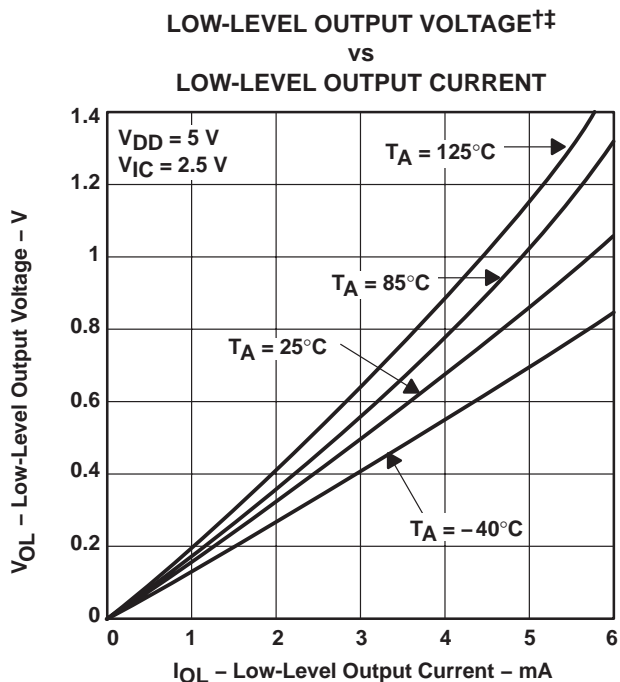


† Data at high and low temperatures are applicable only within the rated operating free-air temperature ranges of the various devices.  
 ‡ For all curves where  $V_{DD} = 5\text{ V}$ , all loads are referenced to 2.5 V. For all curves where  $V_{DD} = 3\text{ V}$ , all loads are referenced to 1.5 V.

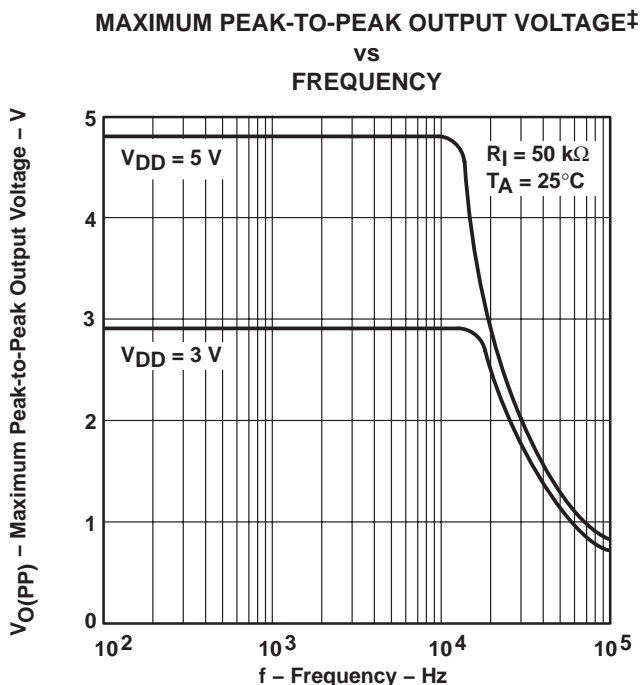
**TYPICAL CHARACTERISTICS**



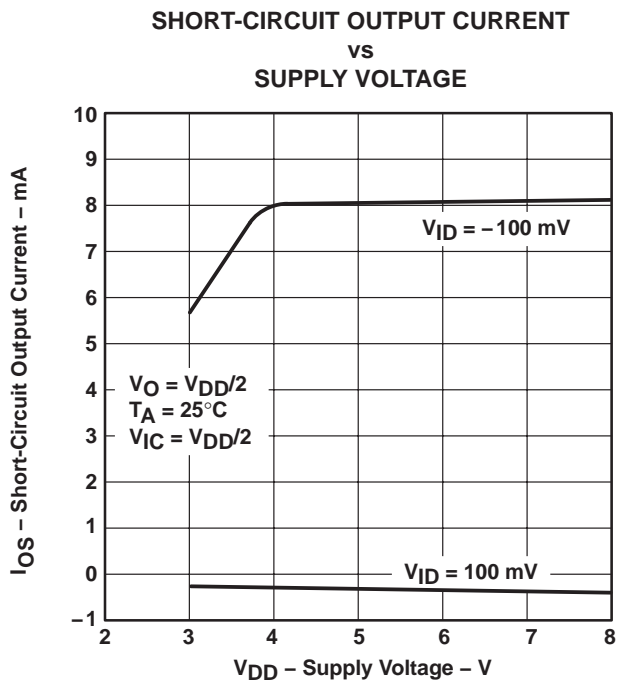
**Figure 18**



**Figure 19**



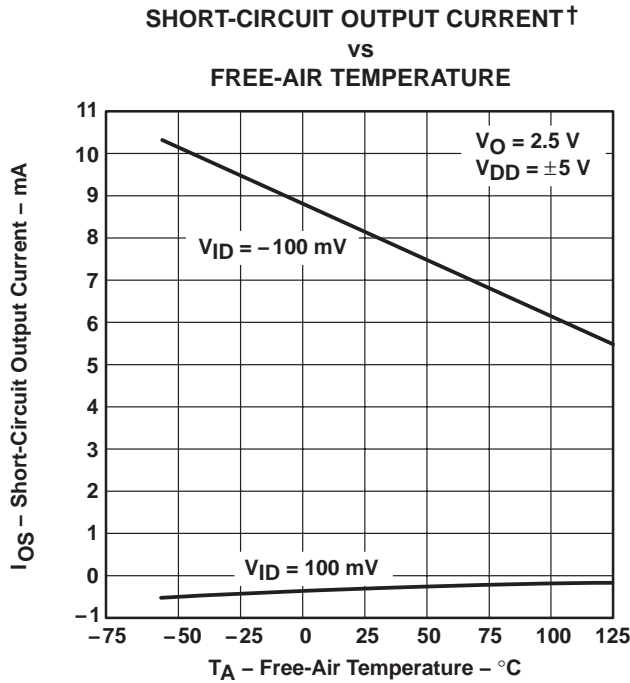
**Figure 20**



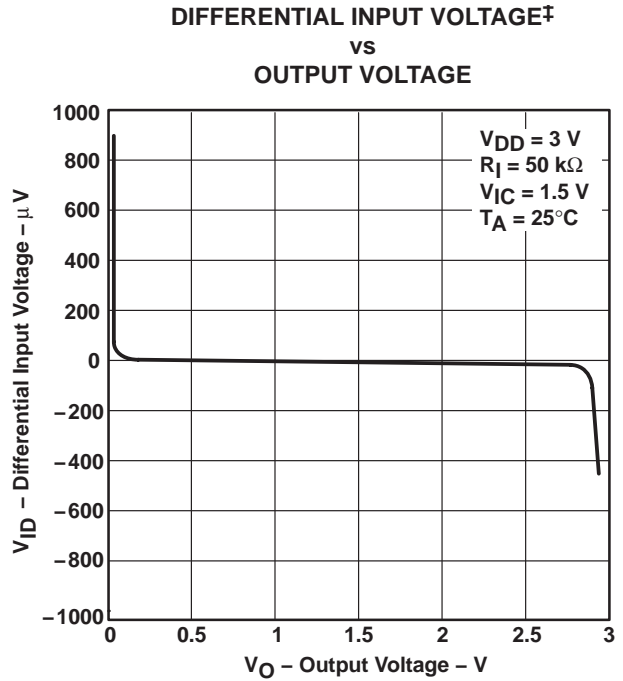
**Figure 21**

† Data at high and low temperatures are applicable only within the rated operating free-air temperature ranges of the various devices.  
 ‡ For all curves where  $V_{DD} = 5 V$ , all loads are referenced to 2.5 V. For all curves where  $V_{DD} = 3 V$ , all loads are referenced to 1.5 V.

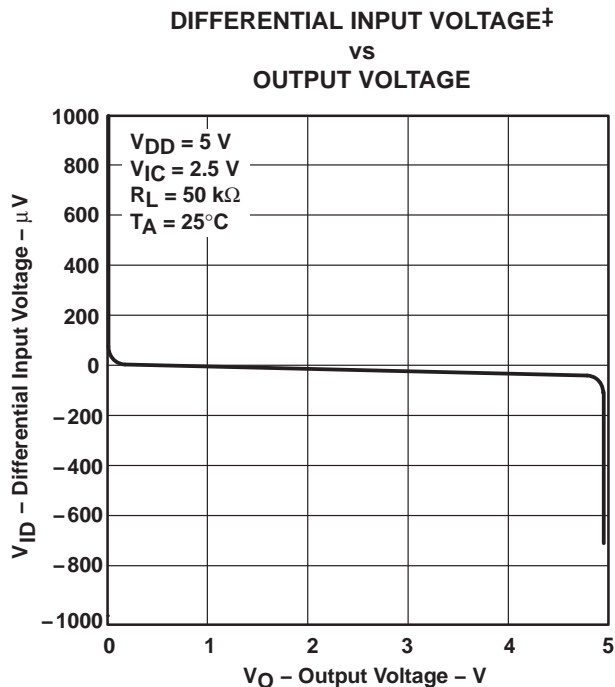
**TYPICAL CHARACTERISTICS**



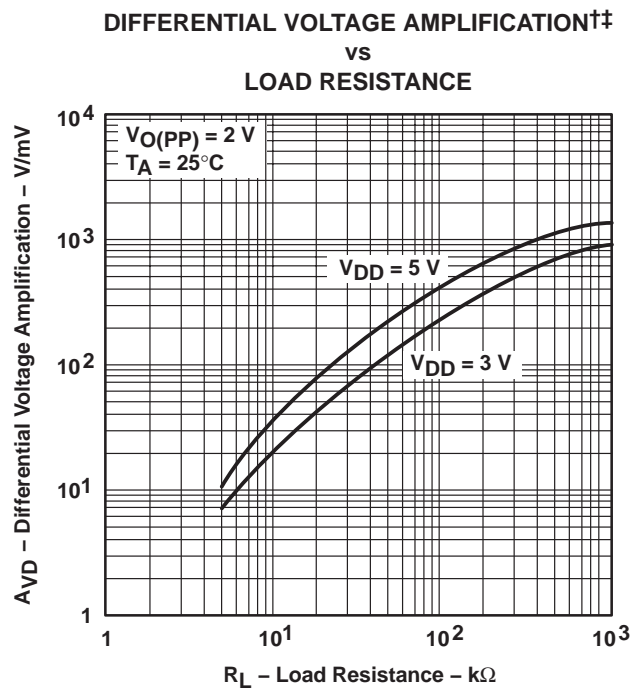
**Figure 22**



**Figure 23**



**Figure 24**



**Figure 25**

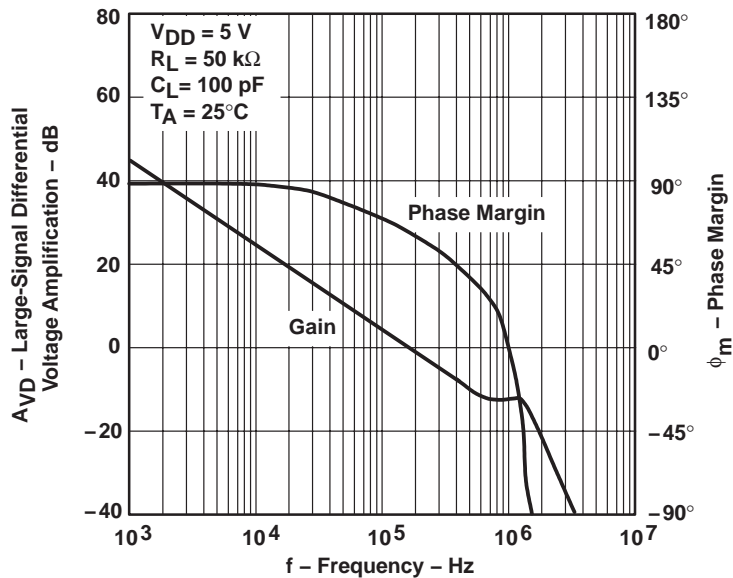
† Data at high and low temperatures are applicable only within the rated operating free-air temperature ranges of the various devices.  
 ‡ For all curves where  $V_{DD} = 5\text{ V}$ , all loads are referenced to 2.5 V. For all curves where  $V_{DD} = 3\text{ V}$ , all loads are referenced to 1.5 V.

**TLV225x-Q1, TLV225xA-Q1**  
**Advanced LinCMOS™ RAIL-TO-RAIL**  
**VERY LOW-POWER OPERATIONAL AMPLIFIERS**

SGLS192A – OCTOBER 2003 – REVISED MARCH 2004

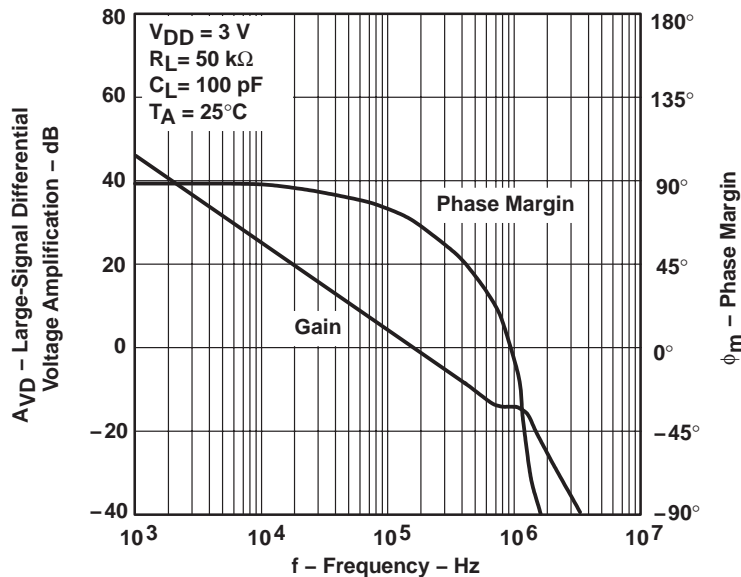
**TYPICAL CHARACTERISTICS**

**LARGE-SIGNAL DIFFERENTIAL VOLTAGE†  
 AMPLIFICATION AND PHASE MARGIN  
 vs  
 FREQUENCY**



**Figure 26**

**LARGE-SIGNAL DIFFERENTIAL VOLTAGE†  
 AMPLIFICATION AND PHASE MARGIN  
 vs  
 FREQUENCY**



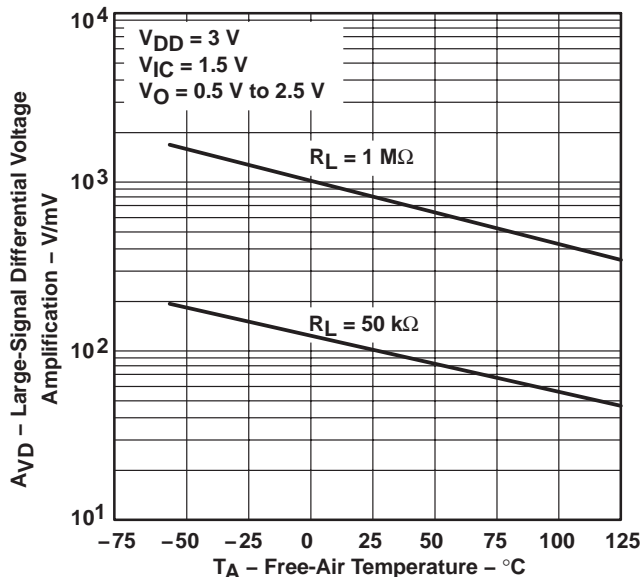
**Figure 27**

† For all curves where  $V_{DD} = 5\text{ V}$ , all loads are referenced to 2.5 V. For all curves where  $V_{DD} = 3\text{ V}$ , all loads are referenced to 1.5 V.



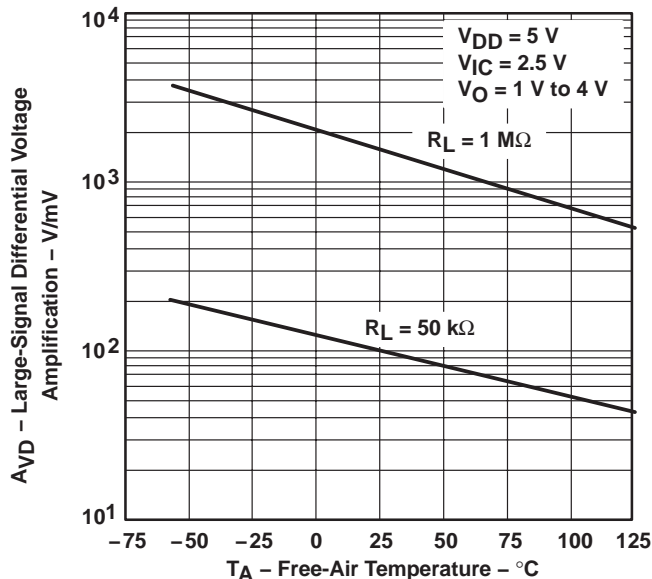
**TYPICAL CHARACTERISTICS**

**LARGE-SIGNAL DIFFERENTIAL†  
 VOLTAGE AMPLIFICATION  
 vs  
 FREE-AIR TEMPERATURE**



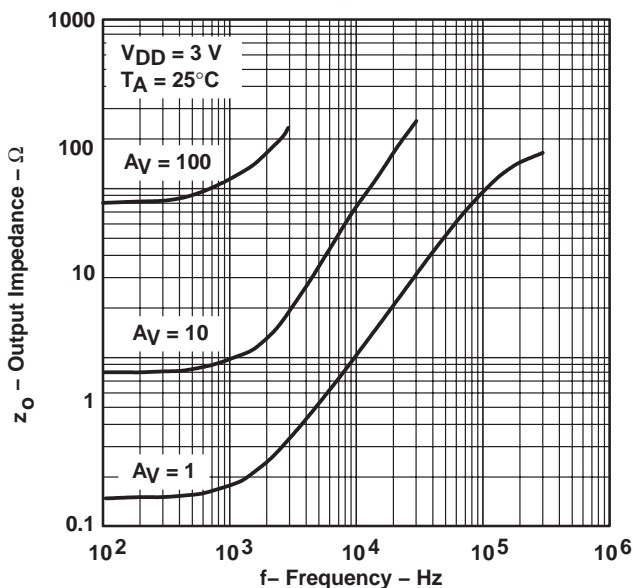
**Figure 28**

**LARGE-SIGNAL DIFFERENTIAL†  
 VOLTAGE AMPLIFICATION  
 vs  
 FREE-AIR TEMPERATURE**



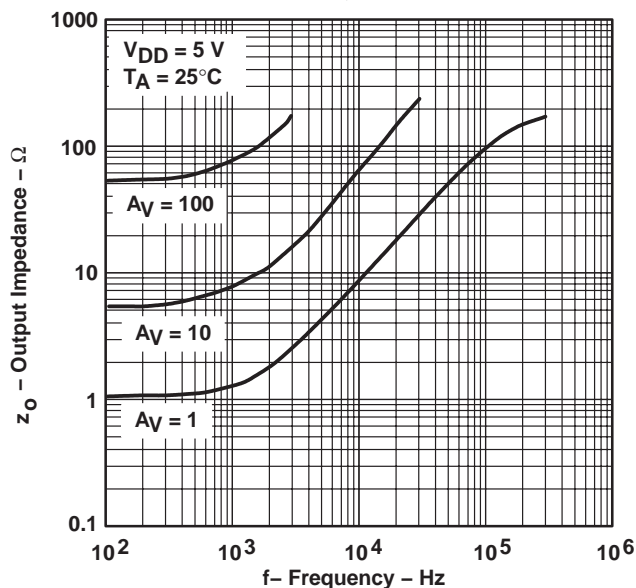
**Figure 29**

**OUTPUT IMPEDANCE‡  
 vs  
 FREQUENCY**



**Figure 30**

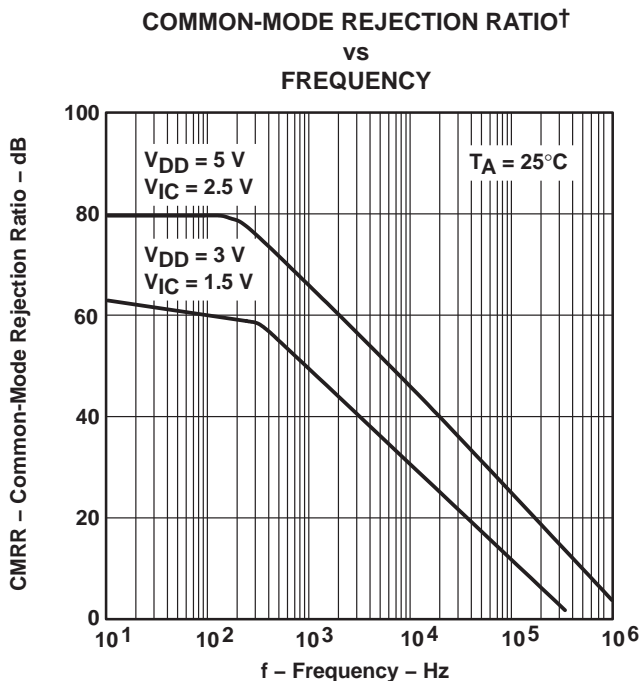
**OUTPUT IMPEDANCE‡  
 vs  
 FREQUENCY**



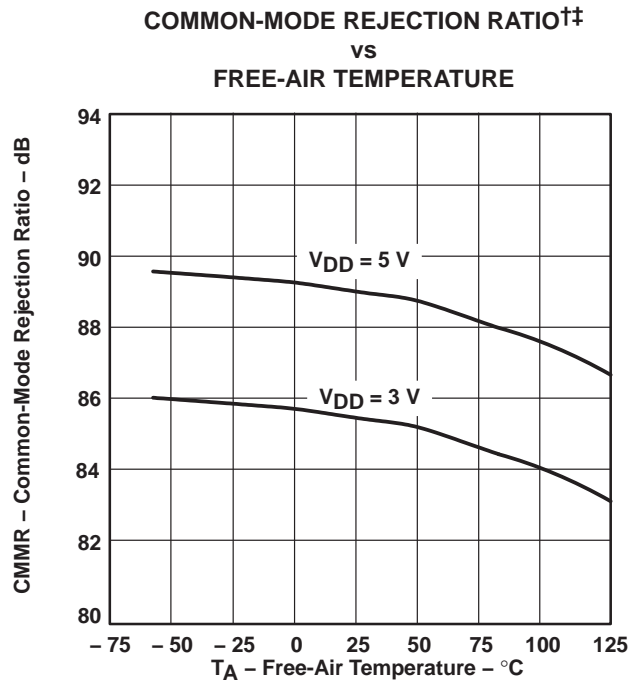
**Figure 31**

† Data at high and low temperatures are applicable only within the rated operating free-air temperature ranges of the various devices.  
 ‡ For all curves where  $V_{DD} = 5\text{ V}$ , all loads are referenced to 2.5 V. For all curves where  $V_{DD} = 3\text{ V}$ , all loads are referenced to 1.5 V.

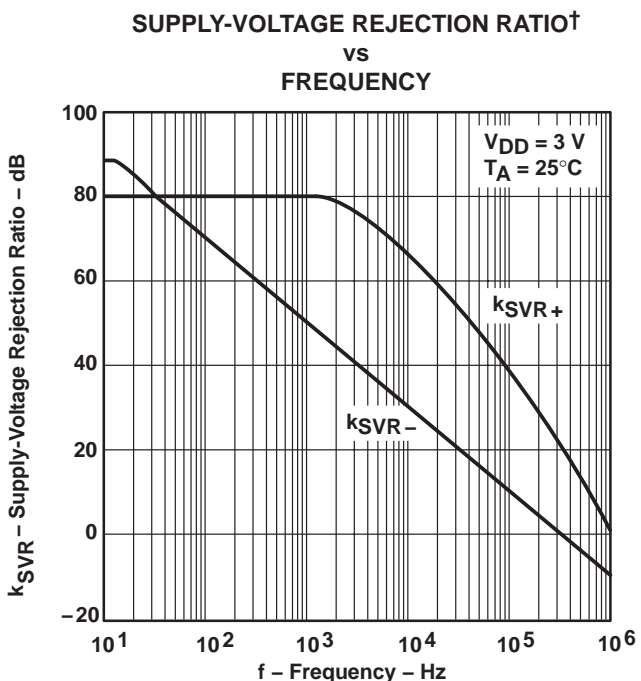
**TYPICAL CHARACTERISTICS**



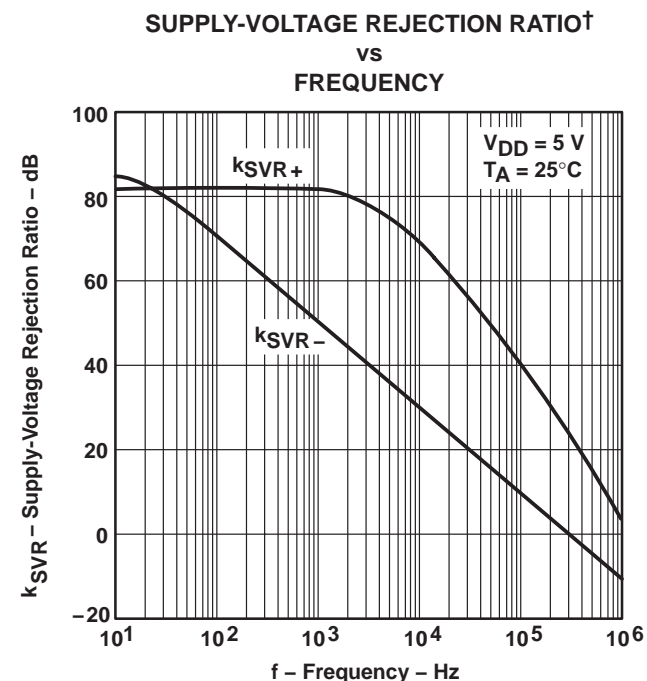
**Figure 32**



**Figure 33**



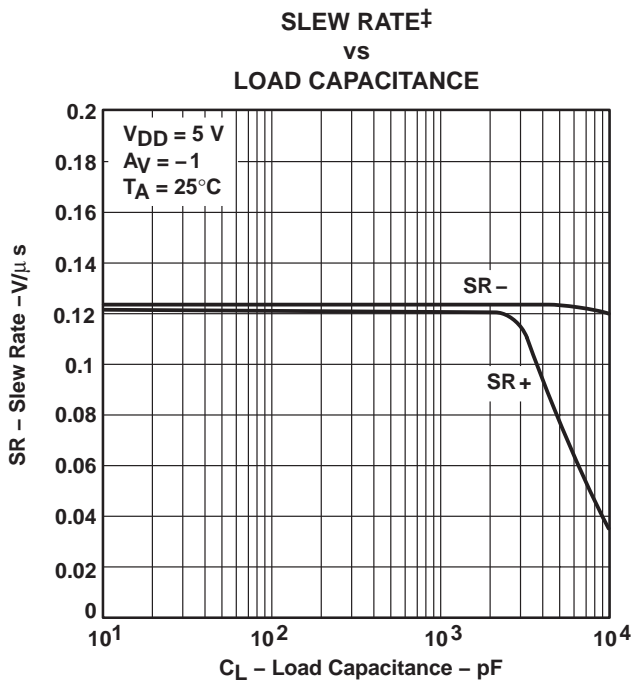
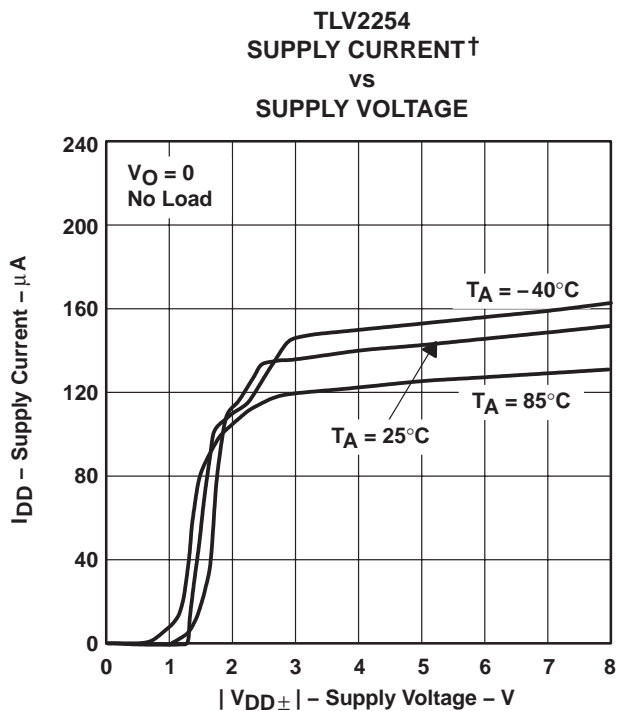
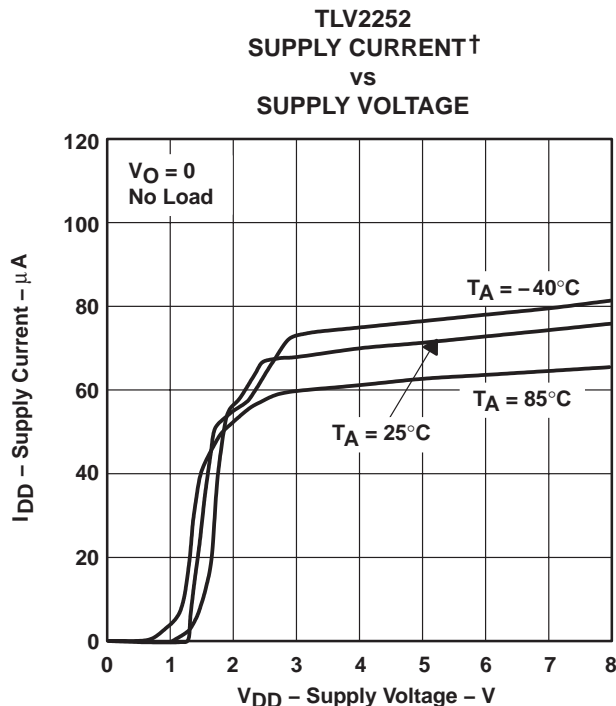
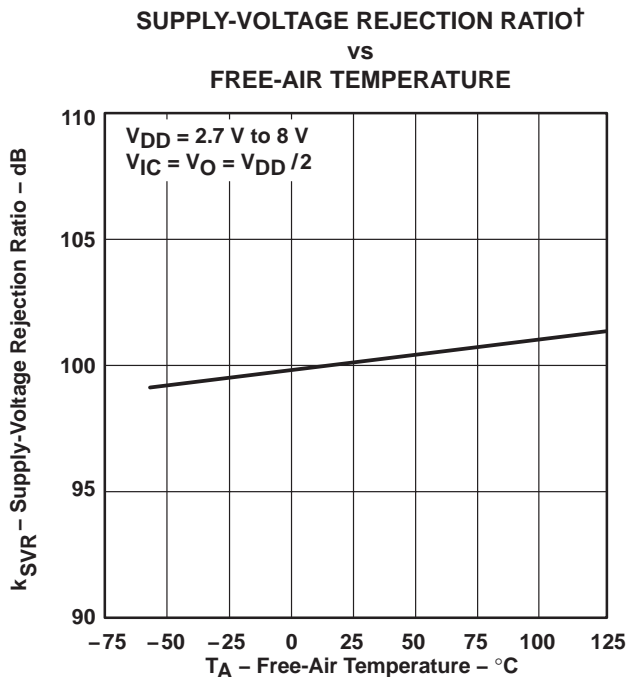
**Figure 34**



**Figure 35**

† For all curves where  $V_{DD} = 5\text{ V}$ , all loads are referenced to 2.5 V. For all curves where  $V_{DD} = 3\text{ V}$ , all loads are referenced to 1.5 V.  
 ‡ Data at high and low temperatures are applicable only within the rated operating free-air temperature ranges of the various devices.

**TYPICAL CHARACTERISTICS**



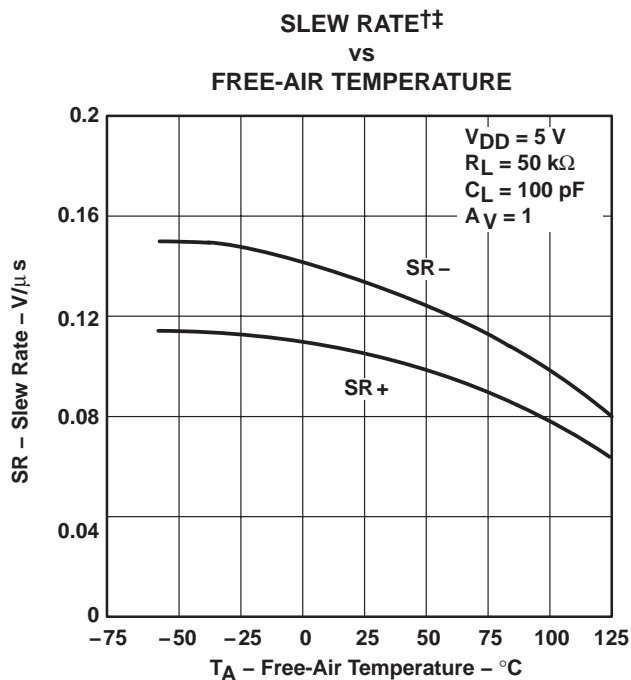
† Data at high and low temperatures are applicable only within the rated operating free-air temperature ranges of the various devices.

‡ For all curves where  $V_{DD} = 5$  V, all loads are referenced to 2.5 V. For all curves where  $V_{DD} = 3$  V, all loads are referenced to 1.5 V.

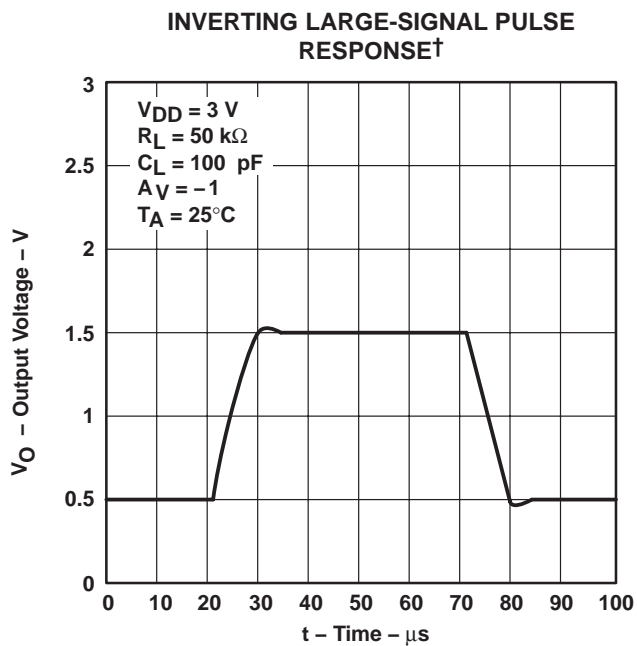
**TLV225x-Q1, TLV225xA-Q1**  
**Advanced LinCMOS™ RAIL-TO-RAIL**  
**VERY LOW-POWER OPERATIONAL AMPLIFIERS**

SGLS192A – OCTOBER 2003 – REVISED MARCH 2004

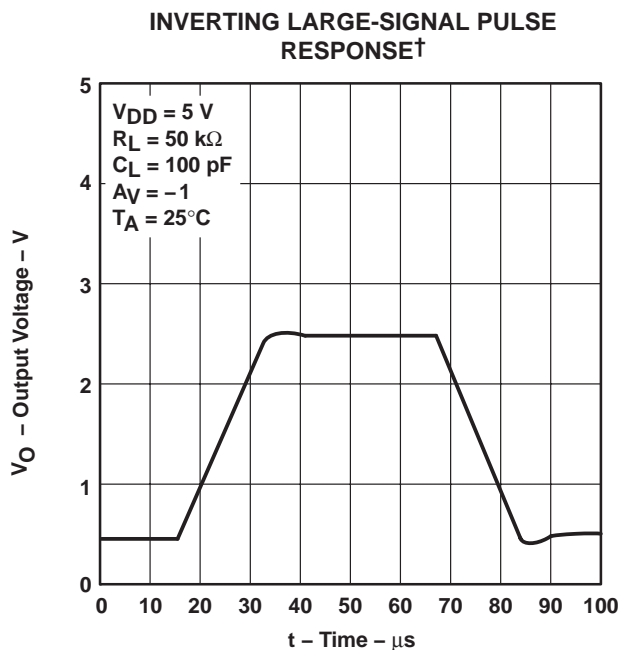
**TYPICAL CHARACTERISTICS**



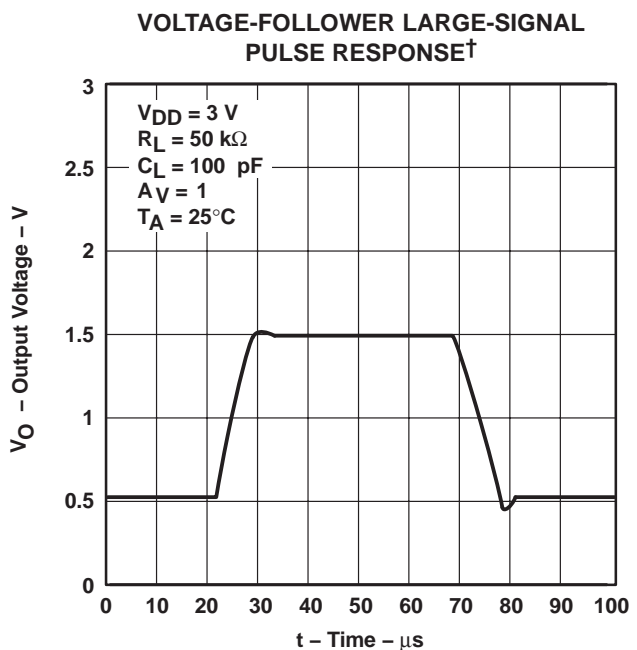
**Figure 40**



**Figure 41**



**Figure 42**

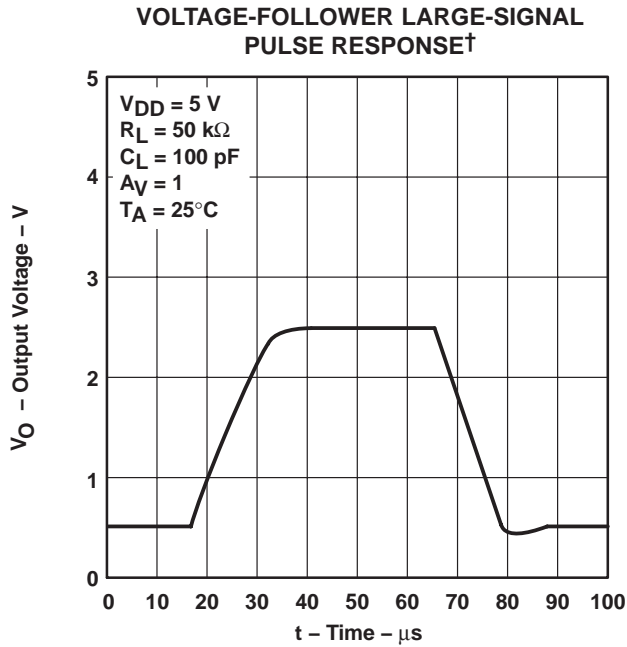


**Figure 43**

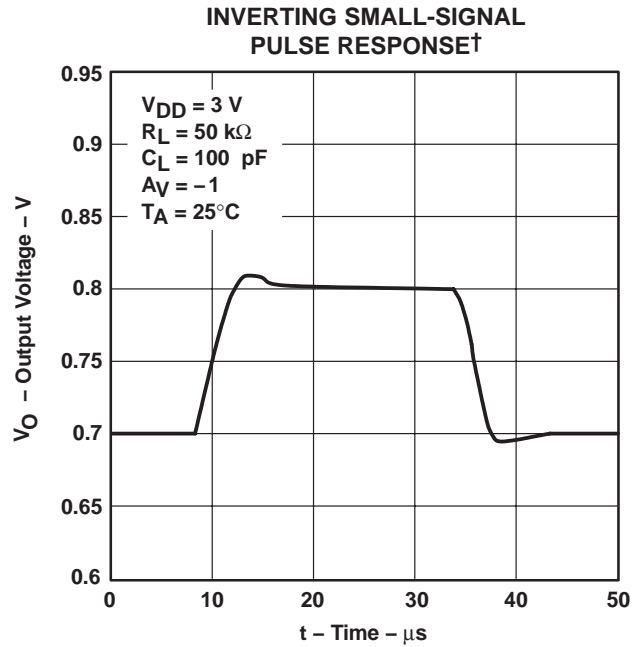
† Data at high and low temperatures are applicable only within the rated operating free-air temperature ranges of the various devices.  
 ‡ For all curves where  $V_{DD} = 5\text{ V}$ , all loads are referenced to 2.5 V. For all curves where  $V_{DD} = 3\text{ V}$ , all loads are referenced to 1.5 V.



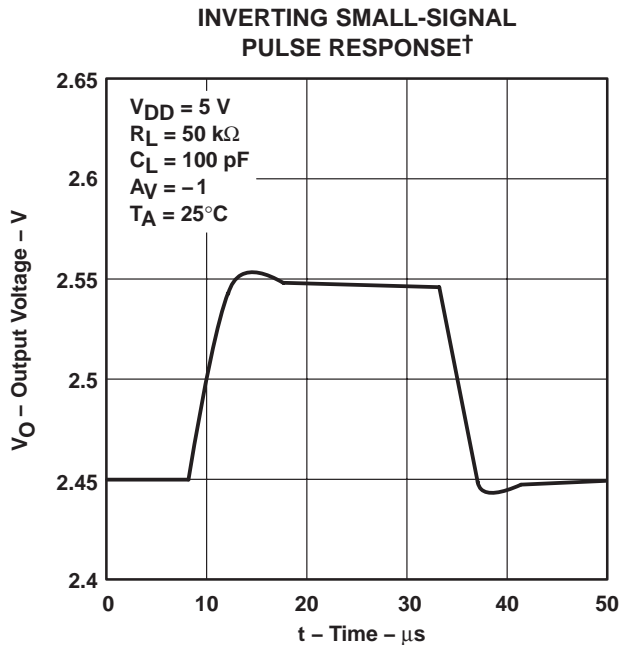
**TYPICAL CHARACTERISTICS**



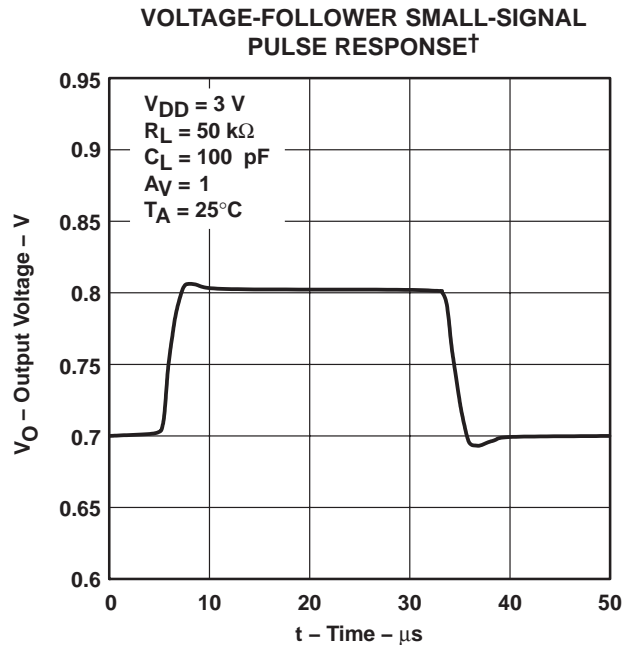
**Figure 44**



**Figure 45**



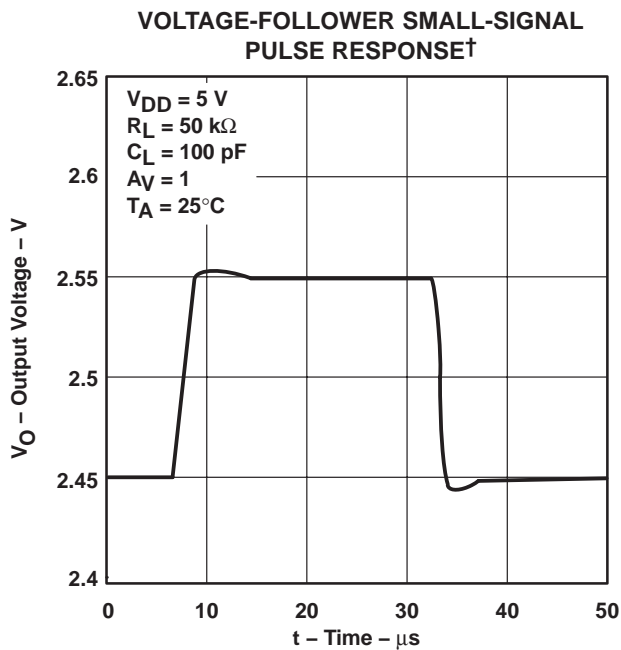
**Figure 46**



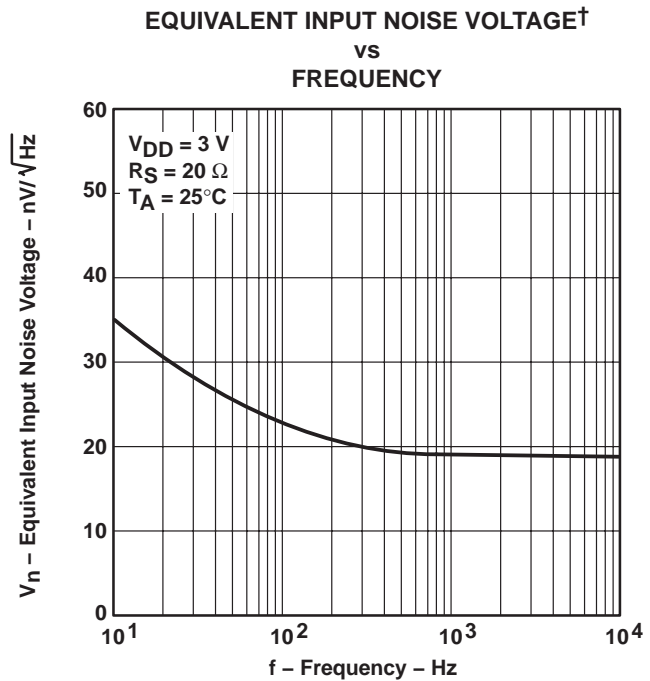
**Figure 47**

† For all curves where  $V_{DD} = 5\text{ V}$ , all loads are referenced to 2.5 V. For all curves where  $V_{DD} = 3\text{ V}$ , all loads are referenced to 1.5 V.

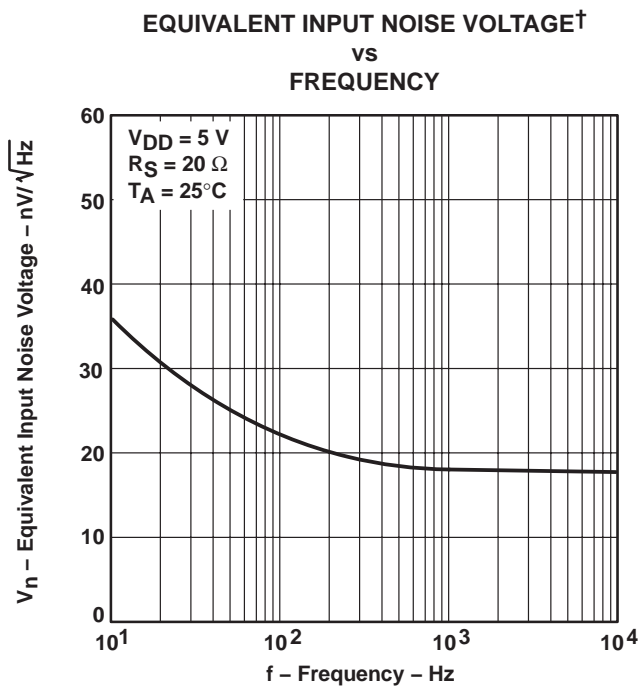
**TYPICAL CHARACTERISTICS**



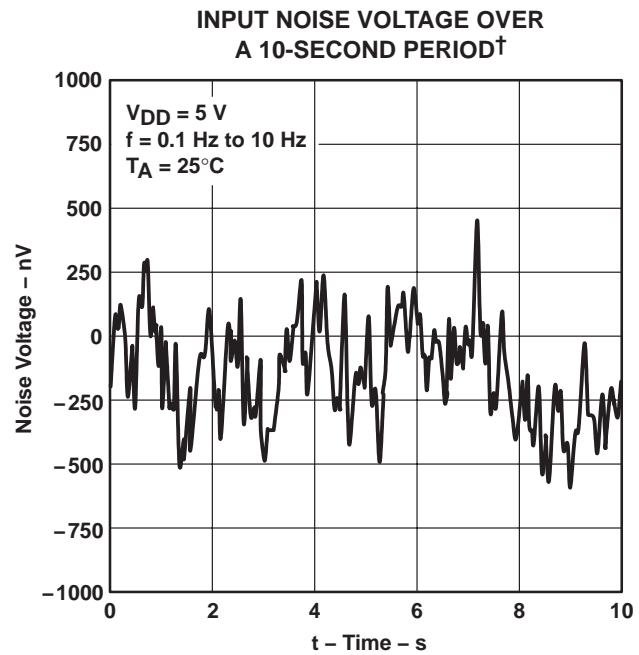
**Figure 48**



**Figure 49**



**Figure 50**



**Figure 51**

† For all curves where  $V_{DD} = 5\text{ V}$ , all loads are referenced to 2.5 V. For all curves where  $V_{DD} = 3\text{ V}$ , all loads are referenced to 1.5 V.

TYPICAL CHARACTERISTICS

INTEGRATED NOISE VOLTAGE†  
 vs  
 FREQUENCY

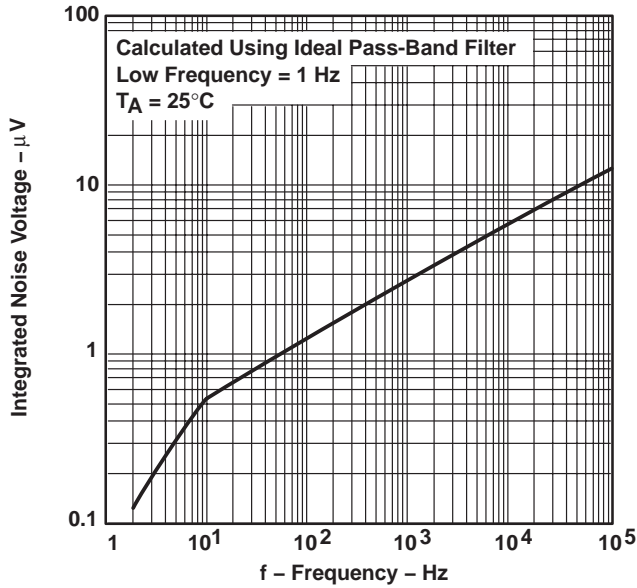


Figure 52

TOTAL HARMONIC DISTORTION PLUS NOISE†  
 vs  
 FREQUENCY

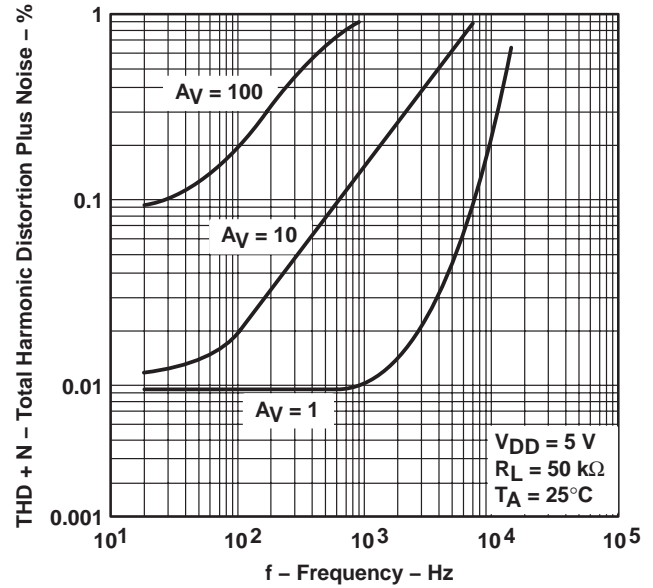


Figure 53

GAIN-BANDWIDTH PRODUCT  
 vs  
 SUPPLY VOLTAGE

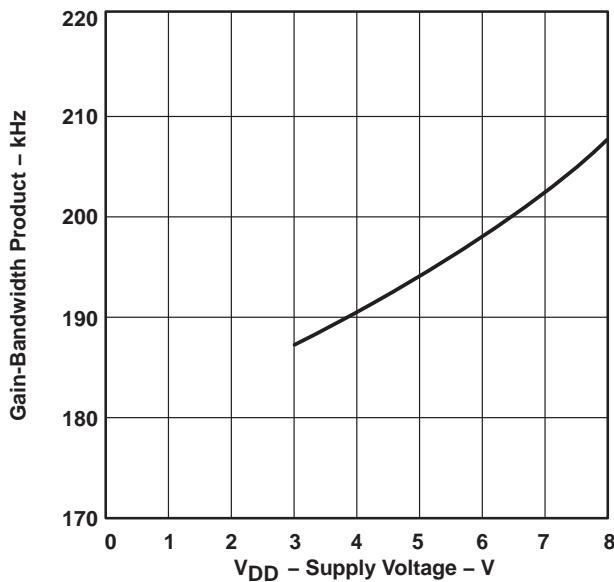


Figure 54

GAIN-BANDWIDTH PRODUCT††  
 vs  
 FREE-AIR TEMPERATURE

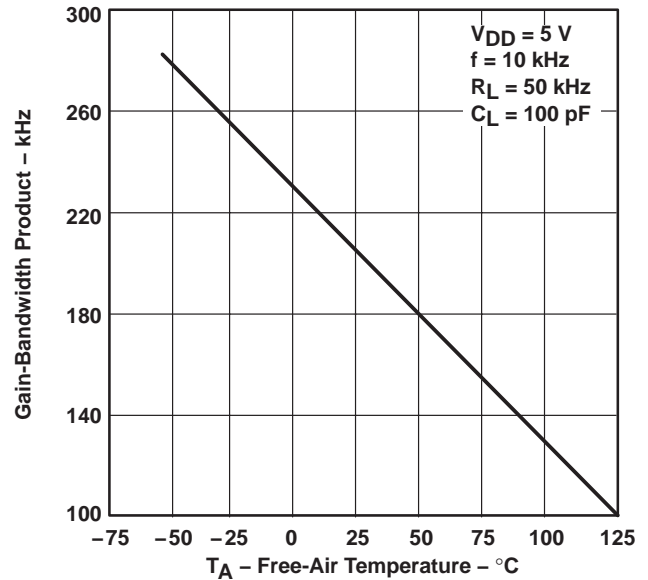
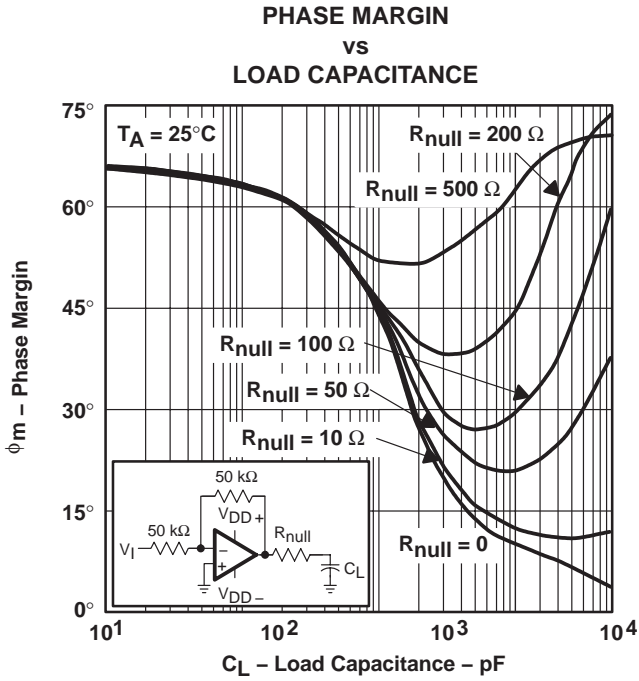


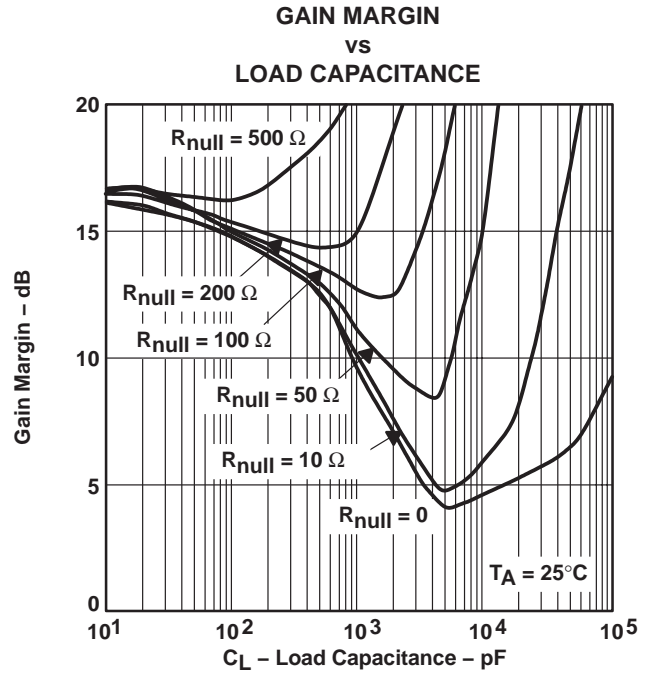
Figure 55

† For all curves where  $V_{DD} = 5\text{ V}$ , all loads are referenced to 2.5 V. For all curves where  $V_{DD} = 3\text{ V}$ , all loads are referenced to 1.5 V.

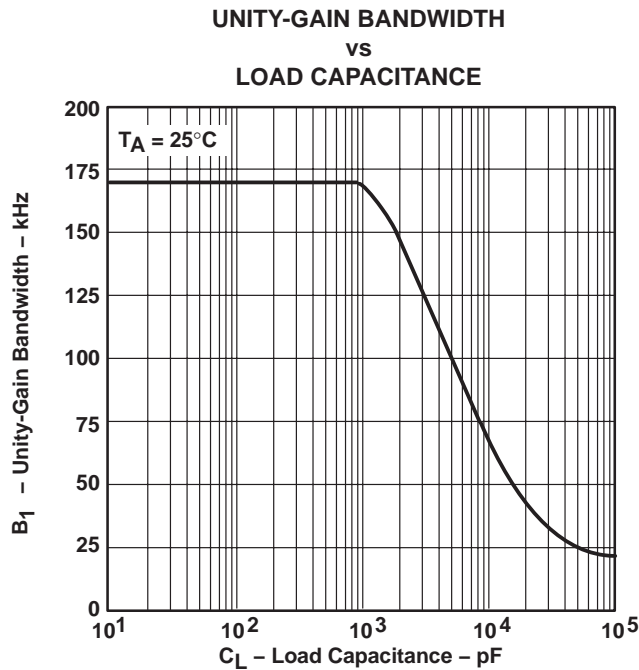
**TYPICAL CHARACTERISTICS**



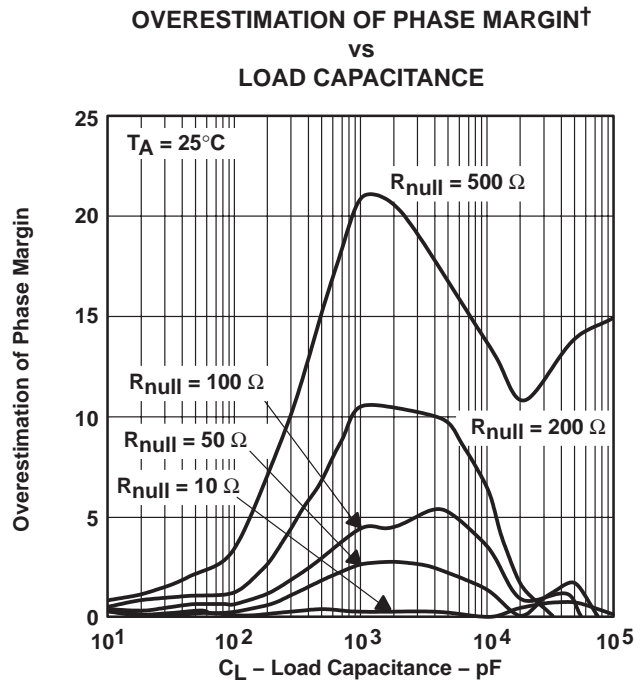
**Figure 56**



**Figure 57**



**Figure 58**



† See application information

**Figure 59**

† For all curves where  $V_{DD} = 5\text{ V}$ , all loads are referenced to 2.5 V. For all curves where  $V_{DD} = 3\text{ V}$ , all loads are referenced to 1.5 V.

‡ Data at high and low temperatures are applicable only within the rated operating free-air temperature ranges of the various devices.

## APPLICATION INFORMATION

### driving large capacitive loads

The TLV2252 is designed to drive larger capacitive loads than most CMOS operational amplifiers. Figure 56 and Figure 57 illustrate its ability to drive loads up to 1000 pF while maintaining good gain and phase margins ( $R_{null} = 0$ ).

A smaller series resistor ( $R_{null}$ ) at the output of the device (see Figure 60) improves the gain and phase margins when driving large capacitive loads. Figure 55 and Figure 56 show the effects of adding series resistances of 10  $\Omega$ , 50  $\Omega$ , 100  $\Omega$ , 200  $\Omega$ , and 500  $\Omega$ . The addition of this series resistor has two effects: the first adds a zero to the transfer function and the second reduces the frequency of the pole associated with the output load in the transfer function.

The zero introduced to the transfer function is equal to the series resistance times the load capacitance. To calculate the improvement in phase margin, equation 1 can be used.

$$\Delta\phi_{m1} = \tan^{-1} \left( 2 \times \pi \times \text{UGBW} \times R_{null} \times C_L \right) \quad (1)$$

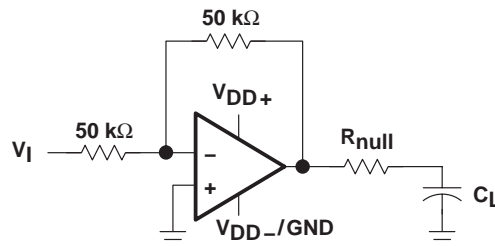
Where :

- $\Delta\phi_{m1}$  = improvement in phase margin
- UGBW = unity-gain bandwidth frequency
- $R_{null}$  = output series resistance
- $C_L$  = load capacitance

The unity-gain bandwidth (UGBW) frequency decreases as the capacitive load increases (see Figure 58). To use equation 1, UGBW must be approximated from Figure 58.

Using equation 1 alone overestimates the improvement in phase margin as illustrated in Figure 59. The overestimation is caused by the decrease in the frequency of the pole associated with the load, providing additional phase shift and reducing the overall improvement in phase margin.

Using Figure 60, with equation 1 enables the designer to choose the appropriate output series resistance to optimize the design of circuits driving large capacitance loads.



**Figure 60. Series-Resistance Circuit**



## PACKAGING INFORMATION

Orderable Device	Status (1)	Package Type	Package Drawing	Pins	Package Qty	Eco Plan (2)	Lead finish/ Ball material (6)	MSL Peak Temp (3)	Op Temp (°C)	Device Marking (4/5)	Samples
TLV2252AQDRG4Q1	ACTIVE	SOIC	D	8	2500	RoHS & Green	NIPDAU	Level-1-260C-UNLIM	-40 to 125	2252AQ	<a href="#">Samples</a>
TLV2252AQDRQ1	ACTIVE	SOIC	D	8	2500	RoHS & Green	NIPDAU	Level-1-260C-UNLIM	-40 to 125	2252AQ	<a href="#">Samples</a>
TLV2252QDRQ1	ACTIVE	SOIC	D	8	2500	RoHS & Green	NIPDAU	Level-1-260C-UNLIM	-40 to 125	2252Q1	<a href="#">Samples</a>

(1) The marketing status values are defined as follows:

**ACTIVE:** Product device recommended for new designs.

**LIFEBUY:** TI has announced that the device will be discontinued, and a lifetime-buy period is in effect.

**NRND:** Not recommended for new designs. Device is in production to support existing customers, but TI does not recommend using this part in a new design.

**PREVIEW:** Device has been announced but is not in production. Samples may or may not be available.

**OBSELETE:** TI has discontinued the production of the device.

(2) **RoHS:** TI defines "RoHS" to mean semiconductor products that are compliant with the current EU RoHS requirements for all 10 RoHS substances, including the requirement that RoHS substance do not exceed 0.1% by weight in homogeneous materials. Where designed to be soldered at high temperatures, "RoHS" products are suitable for use in specified lead-free processes. TI may reference these types of products as "Pb-Free".

**RoHS Exempt:** TI defines "RoHS Exempt" to mean products that contain lead but are compliant with EU RoHS pursuant to a specific EU RoHS exemption.

**Green:** TI defines "Green" to mean the content of Chlorine (Cl) and Bromine (Br) based flame retardants meet JS709B low halogen requirements of <=1000ppm threshold. Antimony trioxide based flame retardants must also meet the <=1000ppm threshold requirement.

(3) MSL, Peak Temp. - The Moisture Sensitivity Level rating according to the JEDEC industry standard classifications, and peak solder temperature.

(4) There may be additional marking, which relates to the logo, the lot trace code information, or the environmental category on the device.

(5) Multiple Device Markings will be inside parentheses. Only one Device Marking contained in parentheses and separated by a "~" will appear on a device. If a line is indented then it is a continuation of the previous line and the two combined represent the entire Device Marking for that device.

(6) Lead finish/Ball material - Orderable Devices may have multiple material finish options. Finish options are separated by a vertical ruled line. Lead finish/Ball material values may wrap to two lines if the finish value exceeds the maximum column width.

**Important Information and Disclaimer:**The information provided on this page represents TI's knowledge and belief as of the date that it is provided. TI bases its knowledge and belief on information provided by third parties, and makes no representation or warranty as to the accuracy of such information. Efforts are underway to better integrate information from third parties. TI has taken and continues to take reasonable steps to provide representative and accurate information but may not have conducted destructive testing or chemical analysis on incoming materials and chemicals. TI and TI suppliers consider certain information to be proprietary, and thus CAS numbers and other limited information may not be available for release.

In no event shall TI's liability arising out of such information exceed the total purchase price of the TI part(s) at issue in this document sold by TI to Customer on an annual basis.

**OTHER QUALIFIED VERSIONS OF TLV2252-Q1, TLV2252A-Q1 :**

- Catalog : [TLV2252](#), [TLV2252A](#)
- Enhanced Product : [TLV2252A-EP](#)
- Military : [TLV2252M](#), [TLV2252AM](#)

NOTE: Qualified Version Definitions:

- Catalog - TI's standard catalog product
- Enhanced Product - Supports Defense, Aerospace and Medical Applications
- Military - QML certified for Military and Defense Applications



# EXAMPLE BOARD LAYOUT

D0008A

SOIC - 1.75 mm max height

SMALL OUTLINE INTEGRATED CIRCUIT



LAND PATTERN EXAMPLE  
 EXPOSED METAL SHOWN  
 SCALE:8X



SOLDER MASK DETAILS

4214825/C 02/2019

NOTES: (continued)

- 6. Publication IPC-7351 may have alternate designs.
- 7. Solder mask tolerances between and around signal pads can vary based on board fabrication site.

# EXAMPLE STENCIL DESIGN

D0008A

SOIC - 1.75 mm max height

SMALL OUTLINE INTEGRATED CIRCUIT



SOLDER PASTE EXAMPLE  
BASED ON .005 INCH [0.125 MM] THICK STENCIL  
SCALE:8X

4214825/C 02/2019

NOTES: (continued)

8. Laser cutting apertures with trapezoidal walls and rounded corners may offer better paste release. IPC-7525 may have alternate design recommendations.
9. Board assembly site may have different recommendations for stencil design.

## IMPORTANT NOTICE AND DISCLAIMER

TI PROVIDES TECHNICAL AND RELIABILITY DATA (INCLUDING DATA SHEETS), DESIGN RESOURCES (INCLUDING REFERENCE DESIGNS), APPLICATION OR OTHER DESIGN ADVICE, WEB TOOLS, SAFETY INFORMATION, AND OTHER RESOURCES "AS IS" AND WITH ALL FAULTS, AND DISCLAIMS ALL WARRANTIES, EXPRESS AND IMPLIED, INCLUDING WITHOUT LIMITATION ANY IMPLIED WARRANTIES OF MERCHANTABILITY, FITNESS FOR A PARTICULAR PURPOSE OR NON-INFRINGEMENT OF THIRD PARTY INTELLECTUAL PROPERTY RIGHTS.

These resources are intended for skilled developers designing with TI products. You are solely responsible for (1) selecting the appropriate TI products for your application, (2) designing, validating and testing your application, and (3) ensuring your application meets applicable standards, and any other safety, security, regulatory or other requirements.

These resources are subject to change without notice. TI grants you permission to use these resources only for development of an application that uses the TI products described in the resource. Other reproduction and display of these resources is prohibited. No license is granted to any other TI intellectual property right or to any third party intellectual property right. TI disclaims responsibility for, and you will fully indemnify TI and its representatives against, any claims, damages, costs, losses, and liabilities arising out of your use of these resources.

TI's products are provided subject to [TI's Terms of Sale](#) or other applicable terms available either on [ti.com](http://ti.com) or provided in conjunction with such TI products. TI's provision of these resources does not expand or otherwise alter TI's applicable warranties or warranty disclaimers for TI products.

TI objects to and rejects any additional or different terms you may have proposed.

Mailing Address: Texas Instruments, Post Office Box 655303, Dallas, Texas 75265  
Copyright © 2022, Texas Instruments Incorporated

## Looking for pricing, stock, or lifecycle information?

Click below to explore more details on WIN SOURCE:

 [View TLV2252AQDRG4Q1 on WIN SOURCE](#)

 [Texas Instruments](#) Information

## Optimize Your Supply Chain with WIN SOURCE Solutions

-  Global Sourcing Solution
-  Obsolete Management
-  Cost Control Management
-  Shortage Management
-  Alternative Solution
-  Excess Inventory Management