



**THE DATASHEET OF
TLC59581RTQT**



TLC59581/82 48-Channel, 16-Bit ES-PWM LED Driver with Pre-Charge FET, LOD Caterpillar Cancelling and Display Data Memory

1 Features

- 48 Constant-Current Sink Output Channels
- Sink Current Capability with Max BC/CC data:
 - 25 mA at 5 VCC
 - 20 mA at 3.3 VCC
- Global Brightness Control (BC): 3-Bit (8-Step)
- Color Brightness Control (CC) for Each Color Group: 9-Bit (512-Step), Three Groups
- LED Power Supply Voltage Up To 10 V
- $V_{CC} = 3.0\text{ V to }5.5\text{ V}$
- Constant Current Accuracy
 - Channel-to-Channel = $\pm 1\%$ (Typ), $\pm 3\%$ (Max)
 - Device-to-Device = $\pm 1\%$ (Typ), $\pm 2\%$ (Max)
- Data Transfer Rate: 25 MHz
- Gray Scale Clock: 33 MHz
- Pre-Charge FET to Avoid Ghosting Phenomenon
- Enhanced Circuit for Caterpillar Cancelling
- Low-Grayscale Enhancement
- LED Open Detection (LOD)
- Thermal Shut Down (TSD)
- Operating Temperature: $-40^{\circ}\text{C to }85^{\circ}\text{C}$

2 Applications

- LED Video Displays with Multiplexing System
- LED Signboards with Multiplexing system
- High Refresh Rate & High Density LED Panel

3 Description

The TLC59581/82 are 48-channel constant-current sink drivers. Each channel has an individually-adjustable, 65536-step, pulse width modulation (PWM) grayscale (GS) brightness control.

The TLC59581 can support 32-multiplexing while TLC59582 can support 16-multiplexing.

The output channels are divided into three groups. Each group has a 512-step color brightness control (CC). CC adjusts brightness control between colors. The maximum current value of all 48 channels can be set by 8-step global brightness control (BC). BC adjusts brightness deviation between LED drivers. GS, CC and BC data are accessible through a serial interface port.

See application note *Build High Density, High Refresh Rate, Multiplexing LED Panel with TLC59581*, [SLVA744](#).

Device Information⁽¹⁾

PART NUMBER	PACKAGE	BODY SIZE (NOM)
TLC59581	VQFN (56)	8.00 mm x 8.00 mm
TLC59582		

(1) For all available packages, see the orderable addendum at the end of the data sheet.

Typical Application Schematic (Multiple Daisy-Chaind TLC59581/82)

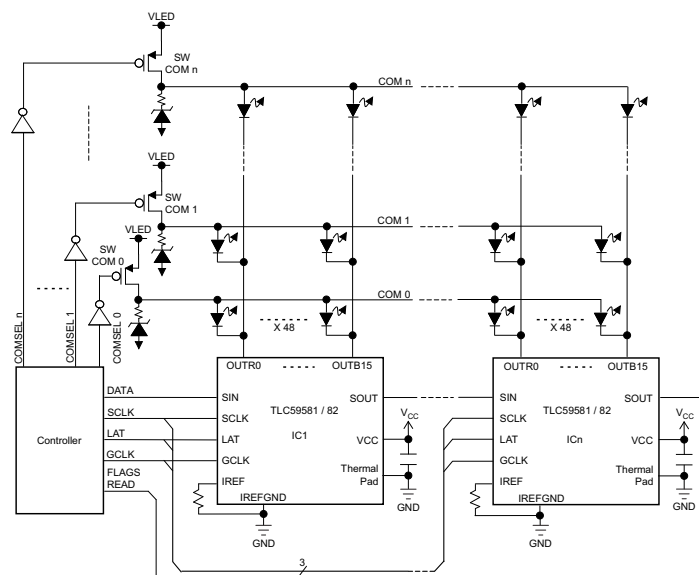

Table of Contents

1 Features	1	9 Detailed Description	15
2 Applications	1	9.1 Overview	15
3 Description	1	9.2 Functional Block Diagram	16
4 Revision History	2	9.3 Device Functional Modes	17
5 Description (continued)	3	10 Application and Implementation	21
6 Pin Configuration and Functions	3	11 Power Supply Recommendations	21
7 Specifications	6	12 Layout	21
7.1 Absolute Maximum Ratings	6	12.1 Layout Guidelines	21
7.2 ESD Ratings	6	12.2 Layout Example	22
7.3 Recommended Operating Conditions	6	13 Device and Documentation Support	22
7.4 Thermal Information	7	13.1 Documentation Support	22
7.5 Electrical Characteristics	8	13.2 Related Links	22
7.6 Typical Characteristics	10	13.3 Community Resources	22
8 Parameter Measurement Information	12	13.4 Trademarks	23
8.1 Pin Equivalent Input and Output Schematic Diagrams	12	13.5 Electrostatic Discharge Caution	23
8.2 Timing Diagrams	14	13.6 Glossary	23
		14 Mechanical, Packaging, and Orderable Information	23

4 Revision History

Changes from Original (October 2015) to Revision A

Page

• Added TLC59582 device to data sheet.	1
---	----------

5 Description (continued)

The TLC59581/82 device has one error flag: the LED open detection (LOD), which can be read through a serial interface port. To resolve this caterpillar issue caused by an open LED, the TLC59581/82 device has an enhanced circuit for caterpillar canceling, thermal shut down (TSD) and I_{REF} resistor short protection (ISP), which ensures a higher system reliability. The TLC59581/82 device also has a power-save mode that sets the total current consumption to 0.8 mA (typical) when all outputs are off. The TLC59581/82 device is a good solution to improve display performance of a multiplexing panel for low-grayscale patterns.

6 Pin Configuration and Functions

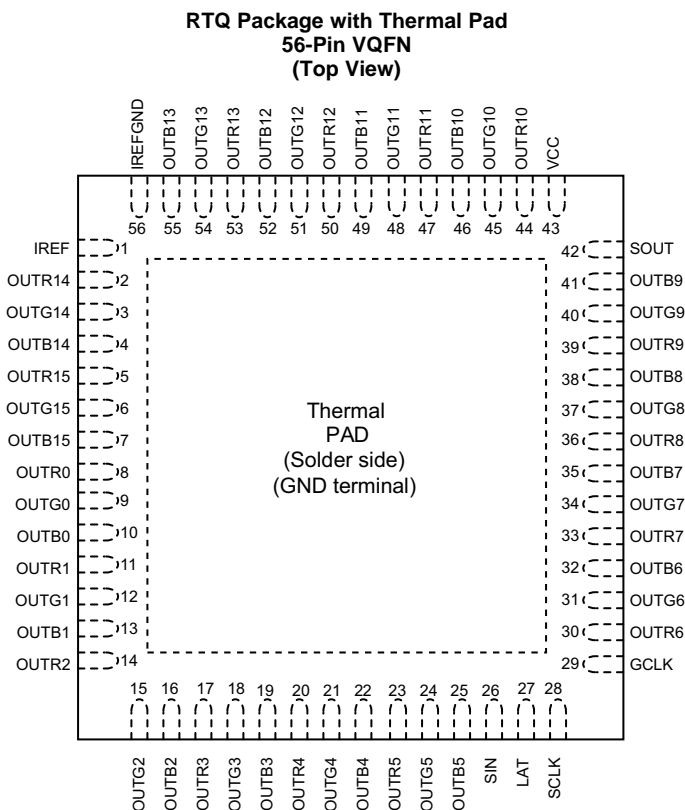

Pin Functions

PIN		I/O	DESCRIPTION
NAME	NO.		
GCLK	29	I	Grayscale(GS) pulse width modulation (PWM) reference clock control for OUTXn. Each GCLK rising edge increase the GS counter by 1 for PWM control.
GND	ThermalPad	–	Power ground. The thermal pad must be soldered to GND on PCB.
IREF	1	–	Maximum constant-current value setting. The OUTR0 to OUTB15 maximum constant output current are set to the desired values by connecting an external resistor between IREF and IREFGND. See ⁽¹⁾ for more detail. The external resistor should be placed close to the device.
IREFGND	56	–	Analog ground. Dedicated ground pin for the external IREF resistor. This pin should be connected to analog ground trace which is connected to power ground near the common GND point of board.

(1) The deviation of each output in same color group (OUTR0~15 or OUTG0~15 or OUTB0~15) from the average of same color group constant current. The deviation is calculated by the formula. (X = R or G or B, n = 0~15)

$$\Delta(\%) = \left[\frac{IOUTXn}{\frac{(IOUTX0 + IOUTX1 + \dots + IOUTX14 + IOUTX15)}{16}} - 1 \right] \times 100$$

Pin Functions (continued)

PIN		I/O	DESCRIPTION
NAME	NO.		
LAT	27	I	The LAT falling edge latches the data from the common shift register into the GS data memory or function control (FC) register FC1 or FC2.
OUTR0	8	O	Constant current output for RED LED. Multiple outputs can be tied together to increase the constant current capability. Different voltages can be applied to each output. These outputs are turned on-off by GCLK signal and the data in GS data memory.
OUTR1	11		
OUTR2	14		
OUTR3	17		
OUTR4	20		
OUTR5	23		
OUTR6	30		
OUTR7	33		
OUTR8	36		
OUTR9	39		
OUTR10	44		
OUTR11	47		
OUTR12	50		
OUTR13	53		
OUTR14	2		
OUTR15	5		
OUTG0	9	O	Constant current output for GREEN LED. Multiple outputs can be tied together to increase the constant current capability. Different voltages can be applied to each output. These outputs are turned on-off by GCLK signal and the data in GS data memory.
OUTG1	12		
OUTG2	15		
OUTG3	18		
OUTG4	21		
OUTG5	24		
OUTG6	31		
OUTG7	34		
OUTG8	37		
OUTG9	40		
OUTG10	45		
OUTG11	48		
OUTG12	51		
OUTG13	54		
OUTG14	3		
OUTG15	6		

Pin Functions (continued)

PIN		I/O	DESCRIPTION
NAME	NO.		
OUTB0	10	O	Constant current output for BLUE LED. Multiple outputs can be tied together to increase the constant current capability. Different voltages can be applied to each output. These outputs are turned on-off by GCLK signal and the data in GS data memory.
OUTB1	13		
OUTB2	16		
OUTB3	19		
OUTB4	22		
OUTB5	25		
OUTB6	32		
OUTB7	35		
OUTB8	38		
OUTB9	41		
OUTB10	46		
OUTB11	49		
OUTB12	52		
OUTB13	55		
OUTB14	4		
OUTB15	7		
SCLK	28	I	Serial data shift clock. Data present on SIN are shifted to the 48-bit common shift register LSB with the SCLK rising edge. Data in the shift register are shifted towards the MSB at each SCLK rising edge. The common shift register MSB appears on SOUT.
SIN	26	I	Serial data input of the 48-bit common shift register. When SIN is high level, the LSB is set to '1' for only one SCLK input rising edge. If two SCLK rising edges are input while SIN is high, then the 48-bit shift register LSB and LSB+1 are set to '1'. When SIN is low, the LSB is set to '0' at the SCLK input rising edge.
SOUT	42	O	Serial data output of the 48-bit common shift register. SOUT is connected to the MSB of the register.
VCC	43	–	Power-supply voltage.

7 Specifications

7.1 Absolute Maximum Ratings

over operating free-air temperature range (unless otherwise noted)⁽¹⁾

PARAMETER			MIN	MAX	UNIT
V _{CC} ⁽²⁾	Supply voltage	VCC	0.3	6.0	V
I _{OUT}	Output current (dc)	OUTx0 to OUTx15, x = R, G, B		30	mA
V _{IN} ⁽²⁾	Input voltage	SIN, SCLK, LAT, GCLK, IREF	−0.3	V _{CC} +0.3	V
V _{OUT} ⁽²⁾	Output voltage	SOUT	−0.3	V _{CC} +0.3	V
		OUTx0 to OUTx15, x = R, G, B	−0.3	11	
T _{J(MAX)}	Operating junction temperature			150	°C
T _{STG}	Storage temperature range		−55	150	°C

- (1) Stresses beyond those listed under *Absolute Maximum Ratings* may cause permanent damage to the device. These are stress ratings only, which do not imply functional operation of the device at these or any other conditions beyond those indicated under *Recommended Operating Conditions*. Exposure to absolute-maximum-rated conditions for extended periods may affect device reliability.
- (2) All voltage values are with respect to device ground terminal.

7.2 ESD Ratings

			MIN	MAX	UNIT
V _(ESD) ⁽¹⁾	Electrostatic discharge	Human body model (HBM), per ANSI/ESDA/JEDEC JS-001, all pins ⁽²⁾	0	4000	V
		Charged device model (CDM), per JEDEC specification JESD22-C101, all pins ⁽³⁾	0	1000	

- (1) Electrostatic discharge (ESD) measures device sensitivity and immunity to damage caused by assembly line electrostatic discharges into the device.
- (2) Level listed above is the passing level per ANSI, ESDA, and JEDEC JS-001. JEDEC document JEP155 states that 500-V HBM allows safe manufacturing with a standard ESD control process.
- (3) Level listed above is the passing level per EIA-JEDEC JESD22-C101. JEDEC document JEP157 states that 250-V CDM allows safe manufacturing with a standard ESD control process.

7.3 Recommended Operating Conditions

At T_A = −40°C to 85°C, unless otherwise noted

			MIN	NOM	MAX	UNIT
DC CHARACTERISTICS, VCC = 3 V to 5.5 V						
V _{CC}	Supply voltage		3		5.5	V
V _O	Voltage applied to output	OUTx0 to OUTx15, x = R, G, B			10	V
V _{IH}	High level input voltage	SIN, SCLK, LAT, GCLK	0.7 × VCC		VCC	V
V _{IL}	Low level input voltage	SIN, SCLK, LAT, GCLK	GND		0.3 × VCC	V
I _{OH}	High level output current	SOUT			−2	mA
I _{OL}	Low level output current	SOUT			2	mA
I _{OLC}	Constant output sink current	OUTx0 to OUTx15, x = R, G, B, 3 V ≤ VCC ≤ 3.6 V			20	mA
		OUTx0 to OUTx15, x = R, G, B, 4 V < VCC ≤ 5.5 V			25	
T _A	Operating free air temperature		−40		85	°C
T _J	Operation junction temperature		−40		125	°C

Recommended Operating Conditions (continued)

At $T_A = -40^{\circ}\text{C}$ to 85°C , unless otherwise noted

			MIN	NOM	MAX	UNIT
AC CHARACTERISTICS, VCC = 3 V to 5.5 V⁽¹⁾						
$F_{\text{CLK(SCLK)}}$	Data shift clock frequency	SCLK			25	MHz
$F_{\text{CLK(GCLK)}}$	Grayscale control clock frequency	GCLK			33	MHz
t_{WH0}	Pulse duration	SCLK	10			ns
t_{WL0}		SCLK	10			
t_{WH1}		GCLK	15			
t_{WL1}		GCLK	10			
t_{SU0}	Setup time	SIN - SCLK \uparrow	2			ns
t_{SU1}		LAT \uparrow - SCLK \uparrow	3			
t_{SU2}		LAT \downarrow - SCLK \uparrow	5			
		LAT \downarrow - SCLK \uparrow , for READSID, READFC1, and READFC2	50			
t_{SU3}		LAT \downarrow (Vsync command) - GCLK \uparrow	2500			
t_{SU4}		The last LAT \downarrow for no all '0' data latching to resume normal mode - GCLK \uparrow , PSAVE_ENA bit = '1b'	50			μS
t_{SU5}	The last GCLK \uparrow - the 1st GCLK \uparrow of next line	20			ns	
t_{H0}	Hold time	SCLK \uparrow - SIN	2			ns
t_{H1}		SCLK \uparrow - LAT \uparrow	2			
t_{H2}		SCLK \uparrow - LAT \downarrow	13			

(1) Specified by design

7.4 Thermal Information

THERMAL METRIC ⁽¹⁾		TLC59581/82	UNIT
		RTQ (VQFN)	
		56 PINS	
$R_{\theta\text{JA}}$	Junction-to-ambient thermal resistance	27.4	$^{\circ}\text{C/W}$
$R_{\theta\text{JC(top)}}$	Junction-to-case (top) thermal resistance	13.6	$^{\circ}\text{C/W}$
$R_{\theta\text{JB}}$	Junction-to-board thermal resistance	5.5	$^{\circ}\text{C/W}$
Ψ_{JT}	Junction-to-top characterization parameter	0.2	$^{\circ}\text{C/W}$
Ψ_{JB}	Junction-to-board characterization parameter	5.5	$^{\circ}\text{C/W}$
$R_{\theta\text{JC(bot)}}$	Junction-to-case (bottom) thermal resistance	0.8	$^{\circ}\text{C/W}$

(1) For more information about traditional and new thermal metrics, see the *Semiconductor and IC Package Thermal Metrics* application report, [SPRA953](#).

7.5 Electrical Characteristics

At $V_{CC} = 3.0\text{ V}$ to 5.5 V and $T_A = -40^\circ\text{C}$ to 85°C , $V_{LED} = 5.0\text{ V}$; Typical values are at $V_{CC} = 3.3\text{ V}$, $T_A = 25^\circ\text{C}$ (unless otherwise noted).

PARAMETER			TEST CONDITIONS	MIN	TYP	MAX	UNIT
V_{OH}	Output voltage	High	$I_{OH} = -2\text{ mA}$ at SOUT	$V_{CC}-0.4$		V_{CC}	V
V_{OL}		Low	$I_{OL} = 2\text{ mA}$ at SOUT			0.4	V
V_{LOD0}	LED open detection threshold		LODVTH = 00b	0.12	0.2	0.28	V
V_{LOD1}			LODVTH = 01b	0.32	0.4	0.48	
V_{LOD2}			LODVTH = 10b	0.52	0.6	0.68	
V_{LOD3}			LODVTH = 11b	0.72	0.8	0.88	
V_{REF}	Reference voltage output		$R_{REF} = 6.2\text{ k}\Omega$ (1 mA target), BC = 0h, CCR/G/B = 81h	1.19	1.209	1.228	V
I_{IN}	Input current (SIN, SCLK)		$V_{IN} = V_{CC}$ or GND	-1		1	μA
I_{CC0}	Supply current (V_{CC})		SIN/SCLK/LAT/GSCLK = GND, GS _n = 0000h, BC = 0h, CCR/G/B = 100h, PCHG_EN = 0, VOUT _n = V_{CC} , RIREF = OPEN		9	11	mA
I_{CC1}			SIN/SCLK/LAT/GSCLK = GND, GS _n = 0000h, BC = 4h, CCR/G/B = 140h, VOUT _n Floating, PCHG_EN = 0, RIREF = 7.5 k Ω ($I_o = 10\text{ mA}$ target)		11	13	
I_{CC2}			SIN/SCLK/LAT = GND, GCLK = 33 MHz, TSU5 = 200 nS, 8+8 mode, GS _n = FFFFh, BC = 4h, CCR/G/B = 140h, VOUT _n = 1 V when channel on, VOUT _n = V_{CC} when channel off. PCHG_EN = 0		25	31	
I_{CC3}			SIN/SCLK/LAT = GND, GCLK = 33 MHz, TSU5 = 200 nS, 8+8 mode, GS _n = FFFFh, BC = 7h, CCR/G/B = 1FFh, VOUT _n = 1 V when channel on, VOUT _n = V_{CC} when channel off. PCHG_EN = 0		28	33	
I_{CC4}			In power save mode and PCHG_EN = 1		1	1.4	
ΔI_{OLC0}	Constant current error (OUTx0-15, x = R/G/B)	Channel-to-channel ⁽¹⁾	All OUT _n = on, BC = 0h, CCR/G/B = 81h, VOUT _n = VOUT _{fix} = 1 V, RIREF = 6.2 k Ω (1 mA target), $T_A = 25^\circ\text{C}$, at same color grouped output of OUTR0-15, OUTG0-15 and OUTB0-15		$\pm 1\%$	$\pm 3\%$	
ΔI_{OLC1}	Constant current error (OUTx0-15, x = R/G/B)	Device-to-device ⁽²⁾	All OUT _n = on, BC = 0h, CCR/G/B = 81h, VOUT _n = VOUT _{fix} = 1 V, RIREF = 6.2 k Ω (1 mA target), $T_A = 25^\circ\text{C}$, at same color grouped output of OUTR0-15, OUTG0-15 and OUTB0-15		$\pm 1\%$	$\pm 2\%$	
ΔI_{OLC2}	Line regulation ⁽³⁾		$V_{CC} = 3.0$ to 5.5 V , All OUT _n = on, BC = 0h, CCR/G/B = 81h, VOUT _n = VOUT _{fix} = 1 V, RIREF = 6.2 k Ω (1 mA target)		± 1	± 1.5	%/V

- (1) The deviation of each output in same color group (OUTR0~15 or OUTG0~15 or OUTB0~15) from the average of same color group constant current. The deviation is calculated by the formula. (X = R or G or B, n = 0~15)

$$\Delta(\%) = \left[\frac{I_{OUTXn}}{\frac{(I_{OUTX0} + I_{OUTX1} + \dots + I_{OUTX14} + I_{OUTX15})}{16}} - 1 \right] \times 100$$

- (2) The deviation of the average of constant-current in each color group from the ideal constant-current value. (X = R or G or B) :

$$\Delta(\%) = \left[\frac{(I_{OUTX0} + I_{OUTX1} + \dots + I_{OUTX15})}{16} - (\text{Ideal Output Current}) \right] \times 100$$

Ideal current is calculated by the following equation:

$$\text{Ideal Output (mA)} = \text{Gain} \times \left[\frac{V_{REF}}{R_{REF}(\Omega)} \right] \times \text{CCR (or CCG, CCB)} / 511d, V_{REF} = 1.209\text{ V (Typ)}$$

Refer to Table 1 for the Gain at chosen BC.

- (3) Line regulation is calculated by the following equation. (X = R or G or B, n = 0~15):

$$\Delta(\%V) = \left[\frac{(I_{OUTXn} \text{ at } V_{CC} = 5.5\text{V}) - (I_{OUTXn} \text{ at } V_{CC} = 3.0\text{V})}{(I_{OUTXn} \text{ at } V_{CC} = 3.0\text{V})} \right] \times \frac{100}{5.5\text{V} - 3\text{V}}$$

Electrical Characteristics (continued)

At $V_{CC} = 3.0\text{ V}$ to 5.5 V and $T_A = -40^\circ\text{C}$ to 85°C , $V_{LED} = 5.0\text{ V}$; Typical values are at $V_{CC} = 3.3\text{ V}$, $T_A = 25^\circ\text{C}$ (unless otherwise noted).

PARAMETER		TEST CONDITIONS	MIN	TYP	MAX	UNIT
ΔI_{OLC3}	Load regulation ⁽⁴⁾	All OUTn = on, BC = 0h, CCR/G/B = 81h, VOUTn = 1 to 3 V, VOUTfix = 1 V, RIREF = 6.2 k Ω (1 mA target)		± 1	± 1.5	%/V
ΔI_{OLC4}	Constant current error (OUTx0-15, x = R/G/B)	Channel-to-channel ⁽¹⁾ All OUTn = on, BC = 7h, CCR/G/B = 1F7h, VOUTn = VOUTfix = 1 V, RIREF = 7.5 k Ω (25 mA target), $T_A = 25^\circ\text{C}$, at same color grouped output of OUTR0-15, OUTG0-15 & OUTB0-15		$\pm 1\%$	$\pm 3\%$	
ΔI_{OLC5}	Constant current error (OUTx0-15, x = R/G/B)	Device-to-device ⁽²⁾ All OUTn = on, BC = 7h, CCR/G/B = 1F7h, VOUTn = VOUTfix = 1 V, RIREF = 7.5 k Ω (25 mA target), $T_A = 25^\circ\text{C}$, at same color grouped output of OUTR0-15, OUTG0-15 and OUTB0-15		$\pm 1\%$	$\pm 2\%$	
ΔI_{OLC6}	Line regulation ⁽³⁾	$V_{CC} = 3.0$ to 5.5 V , All OUTn = on, BC = 7h, CCR/G/B = 1F7h, VOUTn = VOUTfix = 1 V, RIREF = 7.5 k Ω (25 mA target)		± 1	± 1.5	%/V
ΔI_{OLC7}	Load regulation ⁽⁴⁾	All OUTn = on, BC = 7h, CCR/G/B = 1F7h, VOUTn = 1 to 3 V, VOUTfix = 1 V, RIREF = 7.5 k Ω (25 mA target)		± 1	± 1.5	%/V
T_{TSD}	Thermal shutdown threshold ⁽⁵⁾		160	170	180	$^\circ\text{C}$
T_{HYS}	Thermal shutdown hysteresis			10		$^\circ\text{C}$
$V_{ISP(in)}$	IREF resistor short protection threshold		0.15	0.195		V
$V_{ISP(out)}$	IREF resistor short-protection release threshold			0.325	0.4	V
R_{PDWN}	Pull-down resistor	LAT	250	500	750	k Ω
R_{PUP}	Pull-up resistor	GCLK	250	500	750	k Ω
$V_{knee}^{(5)}$	Knee voltage (OUTX 0~15), X = R/G/B	All OUTn = on, BC = 4h, CCR/G/B = 137h, RIREF = 7.5 k Ω . (Io = 10 mA target)		0.32	0.35	V

(4) Load regulation is calculated by the following equation. (X = R or G or B, n = 0~15):

$$\Delta(\%V) = \left[\frac{(I_{OUTXn} \text{ at } V_{OUTXn} = 3V) - (I_{OUTXn} \text{ at } V_{OUTXn} = 1V)}{(I_{OUTXn} \text{ at } V_{OUTXn} = 1V)} \right] \times \frac{100}{3V - 1V}$$

(5) Specified by design.

7.6 Typical Characteristics

$V_{CC} = 3.3\text{ V}$ and $T_A = 25^\circ\text{C}$, unless otherwise noted.

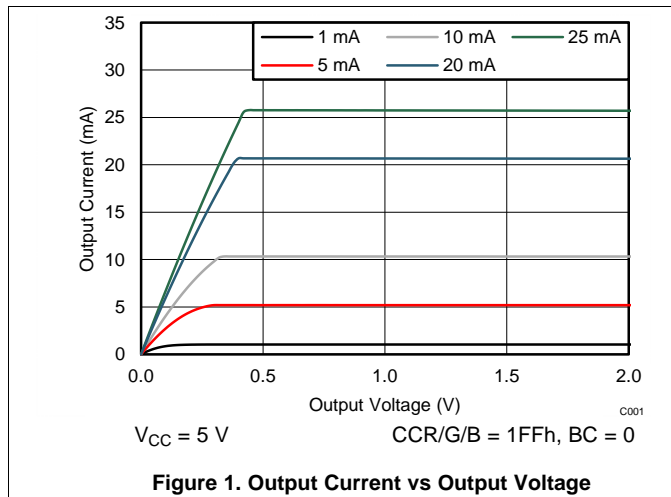

Figure 1. Output Current vs Output Voltage

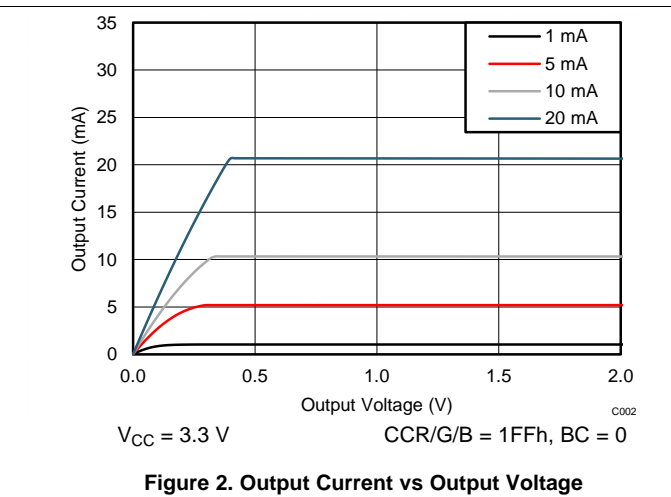

Figure 2. Output Current vs Output Voltage

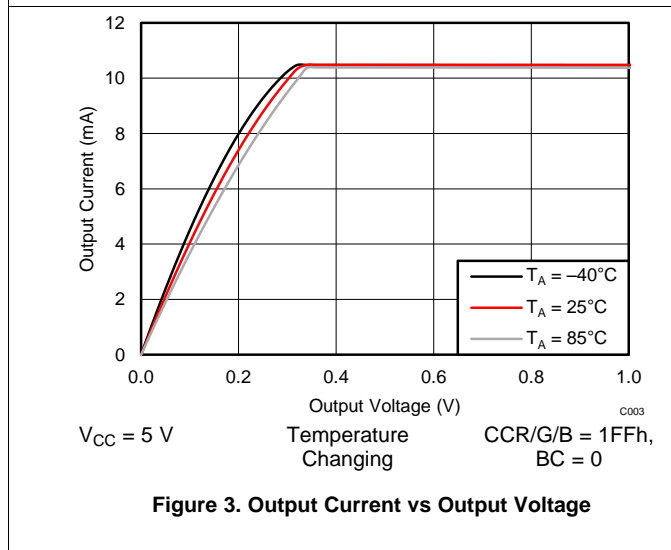

Figure 3. Output Current vs Output Voltage

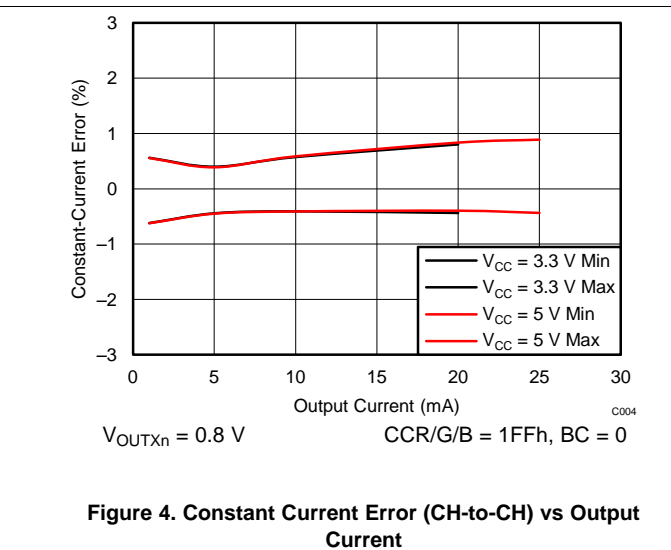

Figure 4. Constant Current Error (CH-to-CH) vs Output Current

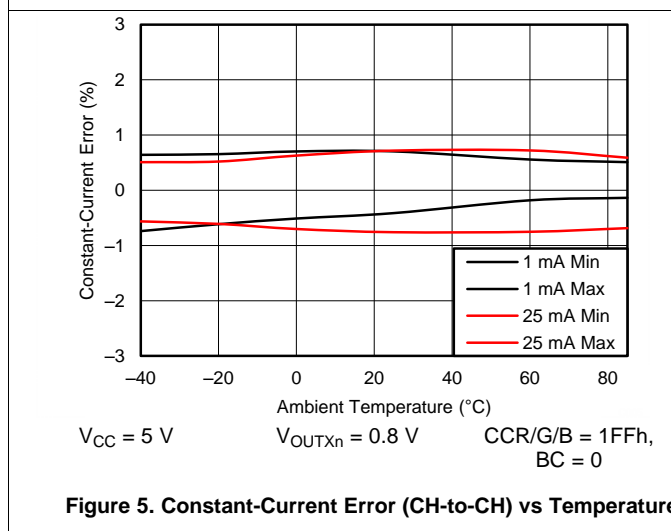

Figure 5. Constant-Current Error (CH-to-CH) vs Temperature

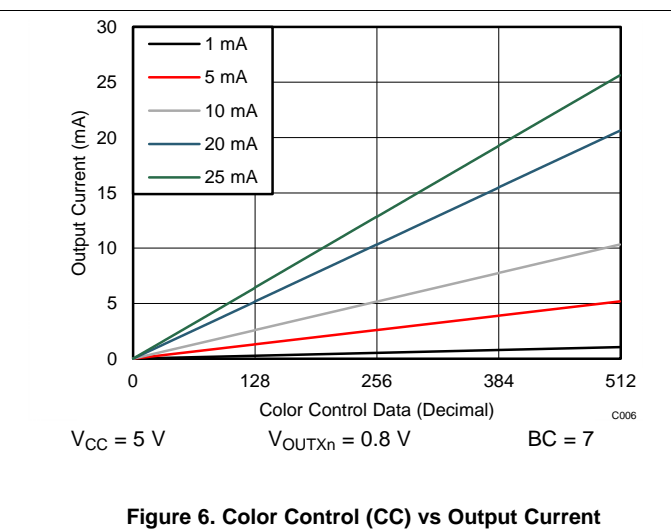

Figure 6. Color Control (CC) vs Output Current

Typical Characteristics (continued)

$V_{CC} = 3.3\text{ V}$ and $T_A = 25^\circ\text{C}$, unless otherwise noted.

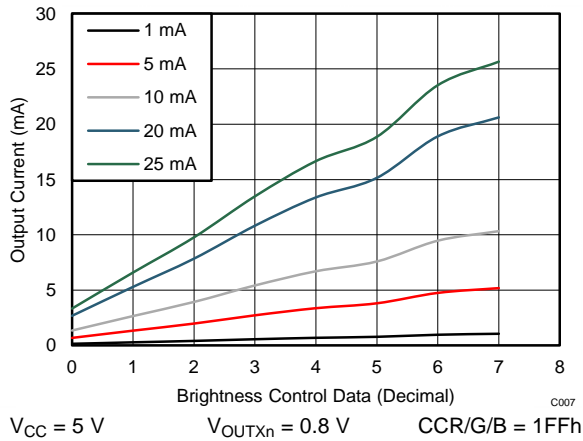

Figure 7. Brightness Control (BC) vs Output Current

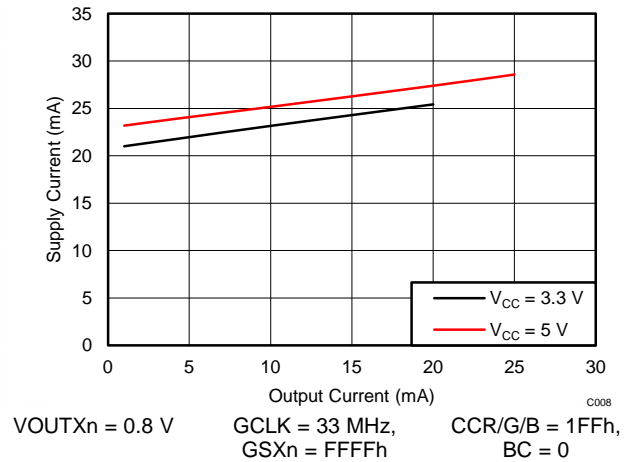

Figure 8. Supply Current (I_{cc}) vs Output Current

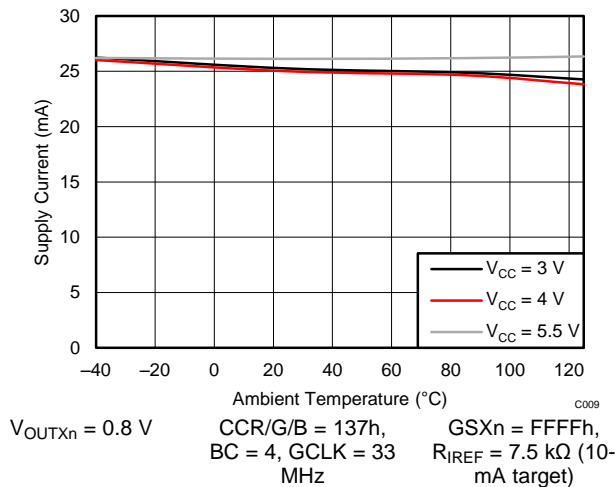

Figure 9. Supply Current (I_{cc}) vs Temperature

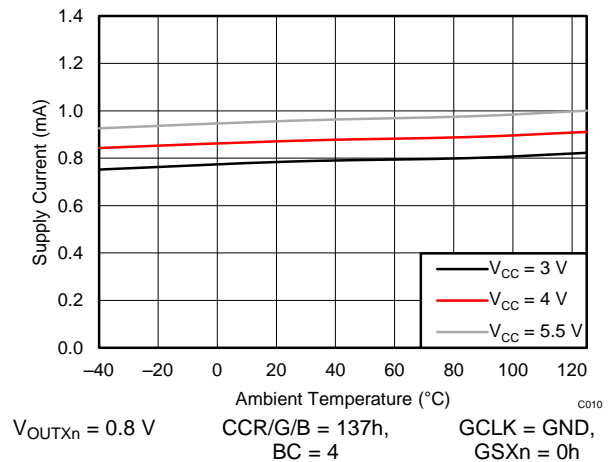

Figure 10. Supply Current in Power Save Mode (I_{cc}) vs Temperature

8 Parameter Measurement Information

8.1 Pin Equivalent Input and Output Schematic Diagrams

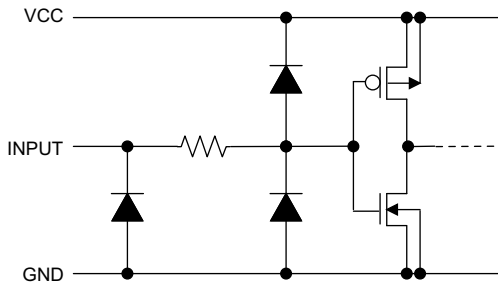

Figure 11. SIN, SCLK

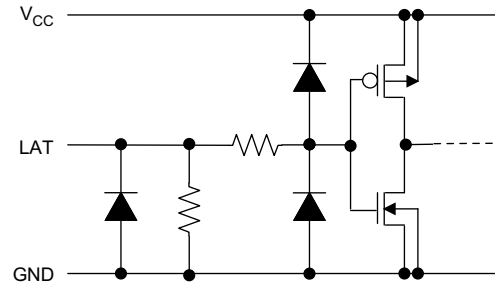

Figure 12. LAT

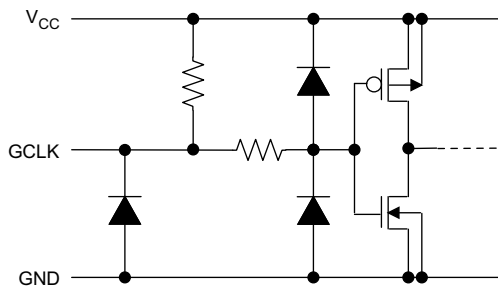

Figure 13. GCLK

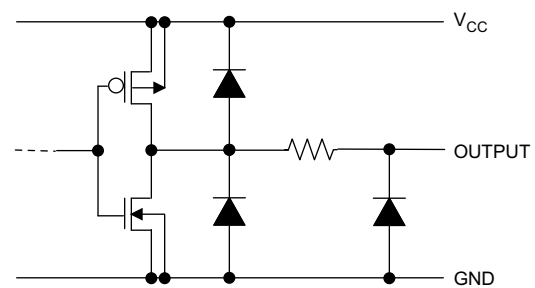

Figure 14. SOUT

(1) X = R or G or B, n = 0~15

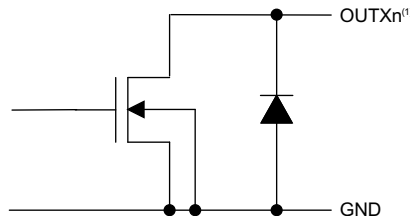

Figure 15. OUTR0/G0/B0 Through OUTR15/G15/B15

Pin Equivalent Input and Output Schematic Diagrams (continued)

8.1.1 Test Circuits

- (1) CL includes measurement probe and jig capacitance.
- (2) X = R or G or B, n = 0~15
- (1) CL includes measurement probe and jig capacitance.

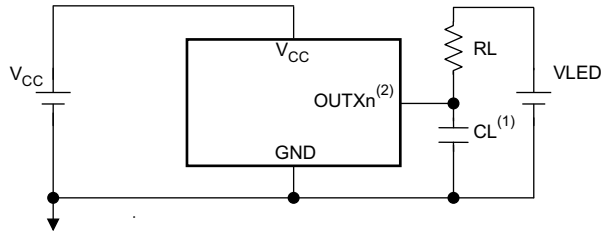

Figure 16. Rise and Fall Time Test Circuit for OUTXn

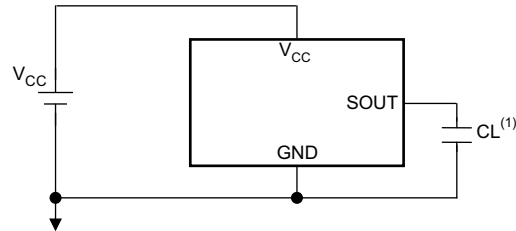

Figure 17. Rise and Fall Time Test Circuit for SOUT

- (1) X = R or G or B, n = 0~15

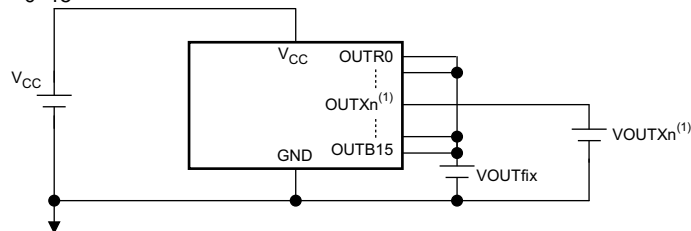
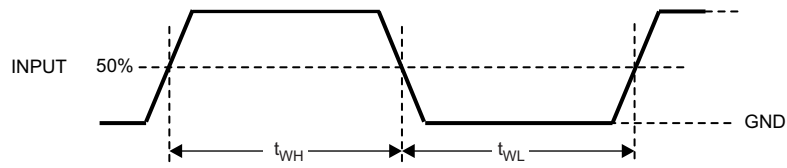

Figure 18. Constant Current Test Circuit for OUTXn

8.2 Timing Diagrams

$t_{WH0}, t_{WL0}, t_{WH1}, t_{WL1}, t_{WH2}$



$t_{SU0}, t_{SU1}, t_{SU2}, t_{SU3}, t_{SU4}, t_{H0}, t_{H1}, t_{H2}$

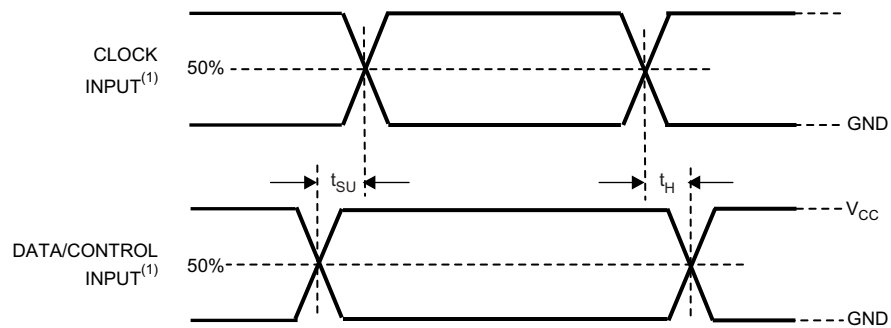

t_{SU5}

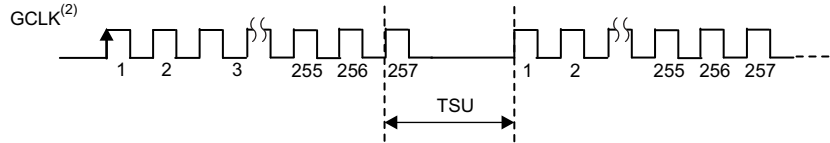

(1) Input pulse rise and fall time is 1~3ns

(2) 8 + 8 mode (SEL_PWM = 0)

Figure 19. Timing Diagrams

9 Detailed Description

9.1 Overview

The TLC59581/82 device is a 48-channel constant-current sink driver for multiplexing system with 1 to 32 duty ratio. Each channel has an individually-adjustable, 65536-step, pulse width modulation (PWM) grayscale (GS).

48-kbit display memory is implemented to increase the visual refresh rate and to decrease the GS data writing frequency.

The support output current of the TLC59581/82 device ranges from 1 mA to 25 mA; channel-to-channel accuracy is 3% max, and device-to-device accuracy is 2% max in all current range. The device also implements Low Gray Scale Enhancement (LGSE) technology to improve the display quality at low grayscale condition. These features make the TLC59581/82 device more suitable for high-density multiplexing application.

The output channels are divided into three groups. Each group has a 512-step color brightness control (CC). CC adjusts brightness control between colors. The maximum current value of all 48 channels can be set by 8-step global brightness control (BC). BC adjusts brightness deviation between LED drivers. GS, CC and BC data are accessible through a serial interface port.

The TLC59581/82 device has one error flag: the LED open detection (LOD), which can be read through a serial interface port. The TLC59581/82 device has an enhanced circuit to resolve this caterpillar issue caused by an open LED. Thermal shut down (TSD) and I_{REF} resistor short protection (ISP) ensure a higher system reliability. The TLC59581/82 device also has a power-save mode that sets the total current consumption to 0.8 mA (typical) when all outputs are off.

The TLC59581 can support 32 multiplexing, and the TLC59582 supports 16 multiplexing.

9.2 Functional Block Diagram

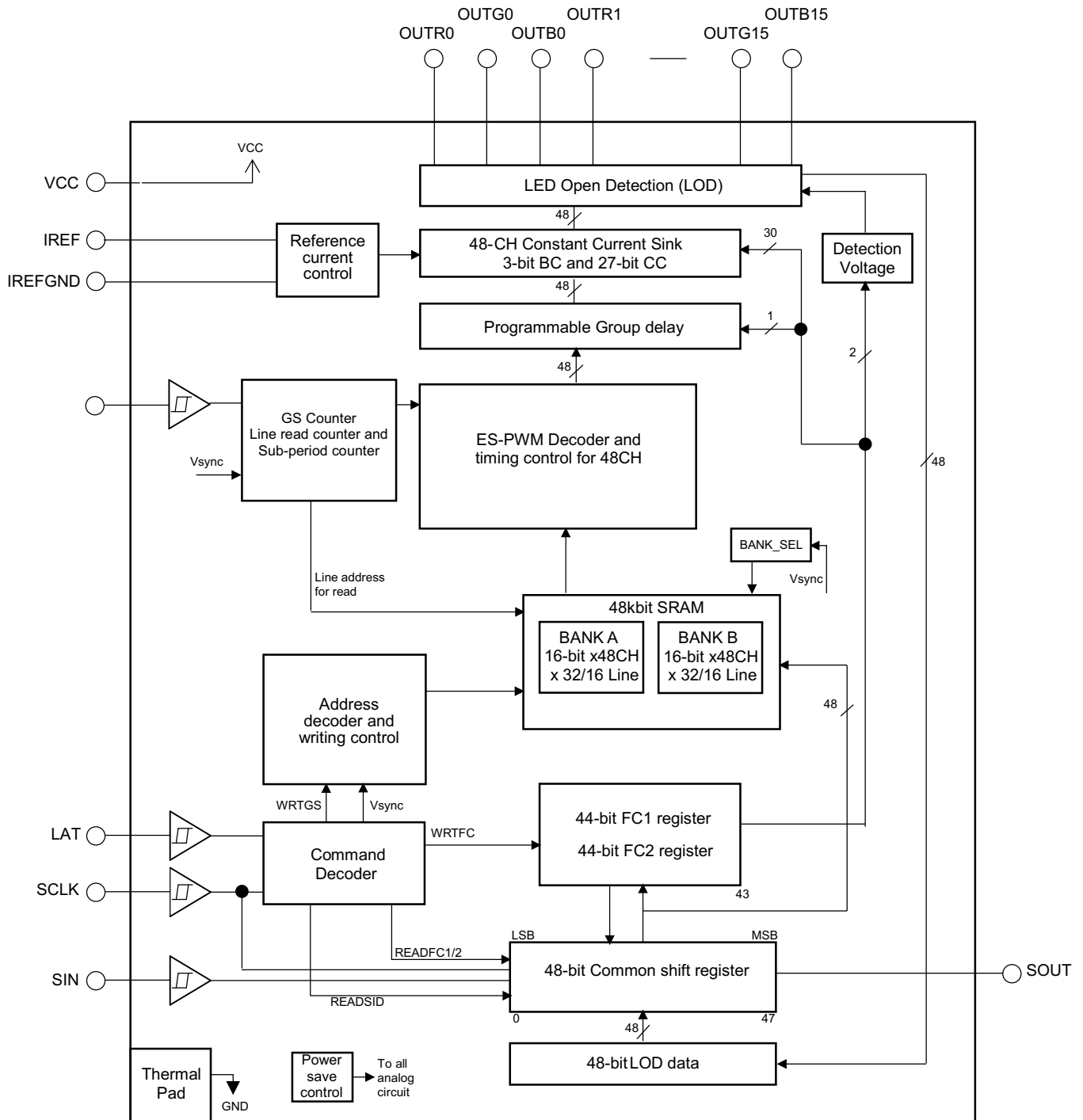

9.3 Device Functional Modes

After power on, all OUTXn of the TLC59581/82 device are turned off. All the internal counters and function control registers (FC1/FC2) are initialized. The following list is a brief summary of the sequence to operate the TLC59581/82 driver that gives users a general idea of how the device works. The function block related to each step is detailed in subsequent sections.

1. According to required LED current, choose BC & CC code, select the current-programming resistor R_{REF} .
2. Send WRTFC command to set FC1/2 register value if the default value need be changed.
3. Write GS data of all lines (max 32/16 lines) into one of the two memory BANKs.
4. Send Vsync command, the BANK with the GS data written just now will be displayed.
5. Input GCLK continuously, 257GCLK (or 129GCLK) as a segment. Between the interval of two segments, supply voltage should be switched from one line to next line accordingly.
6. During the same period of step 5, GS data for next frame should be written into another BANK.
7. When the time of one frame ends, Vsync command should be input to swap the purpose of the two BANKs.

Repeat step 5 through 7.

9.3.1 Brightness Control (BC) Function

The TLC59581/82 device is able to adjust the output current of all constant-current outputs simultaneously. This function is called global brightness control (BC). The global BC for all outputs is programmed with a 3-bit word, thus all output currents can be adjusted in 8 steps from 12.9% to 100% for a given current-programming resistor, R_{REF} (See [Table 2](#)).

BC data can be set through the serial interface. When the BC data changes, the output current also changes immediately. When the device is powered on, the BC data in the function control (FC) register FC1 is set to 4h as the initial value.

9.3.2 Color Brightness Control (CC) Function

The TLC59581/82 device is able to adjust the output current of each of the three color groups OUTR0-OUTR15, OUTG0-OUTG15, and OUTB0-OUTB15 separately. This function is called color brightness control (CC). For each color, it has 9-bit data latch CCR, CCG, or CCB in FC1 register. Thus, all color group output currents can be adjusted in 512 steps from 0% to 100% of the maximum output current, I_{OLCMax} . (See the next section for more detail about I_{OLCMax}). The CC data are entered through the serial interface. When the CC data change, the output current also changes immediately.

When the IC is powered on, the CC data are set to '100h'. [Equation 1](#) calculates the actual output current.

$$I_{out}(mA) = I_{OLCMax}(mA) \times (CCR/511d \text{ or } CCG/511d \text{ or } CCB/511d)$$

where

- I_{OLCMax} = the maximum channel current for each channel, determined by BC data and R_{REF} (see [Equation 2](#))
- CCR/G/B = the color brightness control value for each color group in the FC1 register (000h to 1FFh) (1)

[Table 1](#) shows the CC data versus the constant-current against I_{OLCMax} :

Device Functional Modes (continued)
Table 1. CC Data vs Current Ratio and Set Current Value

CC DATA (CCR or CCG or CCB)			RATIO OF OUTPUT CURRENT TO I_{OLCMax} (%, typical)	OUTPUT CURRENT (mA, $R_{IREF} = 7.41 \text{ k}\Omega$)	
BINARY	DECIMAL	HEX		BC = 7 h ($I_{OLCMax} = 25 \text{ mA}$)	BC = 0 h ($I_{OLCMax} = 3.2 \text{ mA}$)
0 0000 0000	0	00	0	0	0
0 0000 0001	1	01	0.2	0.05	0.006
0 0000 0010	2	02	0.4	0.10	0.013
---	---	---	---	---	---
1 0000 0000 (Default)	256 (Default)	100 (Default)	50.1	12.52	1.621
---	---	---	---	---	---
1 1111 1101	509	1FD	99.6	24.90	3.222
1 1111 1110	510	1FE	99.8	24.95	3.229
1 1111 1111	511	1FF	100.0	25	3.235

9.3.3 Select R_{IREF} For a Given BC

The maximum output current per channel, I_{OLCMax} , is determined by resistor R_{IREF} , placed between the IREF and IREFGND pins, and the BC code in FC1 register. The voltage on IREF is typically 1.209 V. R_{IREF} can be calculated by [Equation 2](#).

$$R_{IREF}(\text{k}\Omega) = V_{IREF}(\text{V}) / I_{OLCMax}(\text{mA}) \times \text{Gain}$$

where

- V_{IREF} = the internal reference voltage on IREF (1.209 V, typical)
 - I_{OLCMax} = the largest current for each output at CCR/G/B = 1FFh.
 - Gain = the current gain at a selected BC code (See [Table 2](#))
- (2)

Table 2. Current Gain Versus BC Code

BC DATA		GAIN	RATIO OF GAIN / GAIN_MAX (AT MAX BC)
BINARY	HEX		
000 (recommend)	0 (recommend)	20.4	12.9%
001	1	40.3	25.6%
010	2	59.7	52.4%
011	3	82.4	12.9%
100 (default)	4 (default)	101.8	64.7%
101	5	115.4	73.3%
110	6	144.3	91.7%
111	7	157.4	100%

NOTE: Recommend using a smaller BC code for better performance. For noise immunity purposes, suggest $R_{IREF} < 60 \text{ k}\Omega$

9.3.4 Choosing BC/CC For a Different Application

BC is mainly used for global brightness adjustment between day and night. Suggested BC is 4h, which is in the middle of the range, allowing flexible changes in brightness up and down.

CC can be used to fine tune the brightness in 512 steps, this is suitable for white balance adjustment between RGB color group. To get a pure white color, the general requirement for the luminous intensity ratio of R, G, B LED is 3:6:1. Depending on the characteristics of the LED (Electro-Optical conversion efficiency), the current ratio of R, G, B LED will be much different from this ratio. Usually, the Red LED needs the largest current. Choose 511d (the max value) CC code for the color group that needs the largest initial current, then choose proper CC code for the other two color groups according to the current ratio requirement of the LED used.

9.3.4.1 Example 1: Red LED Current is 20 mA, Green LED Needs 12 mA, Blue LED needs 8 mA

1. Red LED needs the largest current; choose 511d for CCR
2. $511 \times 12 \text{ mA} / 20 \text{ mA} = 306.6$; choose 307d for CCG. With same method, choose 204d for CCB.
3. According to the required red LED current, choose 7h for BC.
4. According to Equation 2, $R_{\text{REF}} = 1.209 \text{ V} / 20 \text{ mA} \times 157.4 = 9.5 \text{ k}\Omega$

In this example, choose 7h for BC instead of using the default 4h. This is because the Red LED current is 20 mA, approaching the upper limit of current range. To prevent the constant output current from exceeding the upper limit in case a larger BC code is input accidentally, choose the maximum BC code here.

9.3.4.2 Example 2: Red LED Current is 5 mA, Green LED Needs 2 mA, Blue LED Needs 1 mA.

1. Red LED requires the largest current; choose 511d for CCR.
2. $511 \times 2 \text{ mA} / 5 \text{ mA} = 204.4$; choose 204d for CCG. With same method, choose 102d for CCB.
3. According to the required blue LED current, choose 0h for BC.
4. According to Equation 2, $R_{\text{REF}} = 1.209 \text{ V} / 5 \text{ mA} \times 20.4 = 4.93 \text{ k}\Omega$

In this example, choose 0h for BC, instead of using the default 4h. This is because the Blue LED current is 1 mA, is approaching the lower limit of current range. To prevent the constant output current from exceeding the lower limit in case a lower BC code is input accidentally, choose the minimum BC code here. In general, if LED current is in the middle of the range (i.e., 10 mA), use the default 4h as BC code.

9.3.5 LED Open Detection (LOD)

The LOD function detects faults caused by an open circuit in any LED string; or, a short from OUTXn to ground with low impedance. It does this by comparing the OUTXn voltage to the LOD detection threshold voltage level set by LODVLT in the FC1 register. If the OUTXn voltage is lower than the programmed voltage, the corresponding output LOD bit is set to '1' to indicate an open LED. Otherwise, the output of that LOD bit is '0'. LOD data output by the detection circuit are valid only during the 'on' period of that OUTXn output channel. The LOD data are always '0' for outputs that are turned off.

9.3.6 Internal Circuit for Caterpillar Removal

Caterpillar effect is a common issue for the LED panel. It is usually caused by LED lamp open, LED lamp leakage or LED lamp short. The TLC59581/82 device implements an internal circuit that can eliminate the caterpillar issue caused by LED open. The caterpillar removal function is enabled by setting LOD_MMC_EN (bit4 of FC1 register) to '1'. When powered on, the default value of this bit is '0'. When this function is enabled, the IC automatically detects the open LED lamp, and the lamp does not turn on until IC reset.

9.3.7 Power Save Mode (PSM)

The power-save mode (PSM) is enabled by setting PSAVE_ENA (bit5 of FC2 register) to '1'. At power on, this bit default is '0'.

When this function is enabled, if the GS data received for the next frame is all '0', the IC enters power-save mode immediately.

When the IC is in power-save mode, it resumes normal mode when it detects non-zero GS data input. In power-save mode all analog circuits such as constant current output and the LOD circuit are not operational; the device total current consumption, I_{CC} , is below 1 mA.

9.3.8 Internal Pre-Charge FET

The internal pre-charge FET can prevent ghosting of multiplexed LED modules. One cause of this phenomenon is the charging current for parasitic capacitance of the OUTXn through the LED when the supply voltage switches from one common line to the next common line.

To prevent this unwanted charging current, the TLC59581/82 device uses an internal FET to pull OUTXn up to VCC -1.4 V during the common line switching period. As a result, no charging current flows through LED and ghosting is eliminated.

9.3.9 Thermal Shutdown (TSD)

The thermal shutdown (TSD) function turns off all IC constant-current outputs when the junction temperature (T_J) exceeds 170°C (typical). It resumes normal operation when T_J falls below 160°C (typical).

9.3.10 IREF Resistor Short Protection (ISP)

The IREF resistor short protection (ISP) function prevents unwanted large currents from flowing through the constant-current output when the IREF resistor is shorted accidentally. The TLC59581/82 device turns off all output channels when the IREF pin voltage is lower than 0.19 V (typical). When the IREF pin voltage goes higher than 0.325 V (typical), the TLC59581/82 device resumes normal operation.

10 Application and Implementation

NOTE

Information in the following applications sections is not part of the TI component specification, and TI does not warrant its accuracy or completeness. TI's customers are responsible for determining suitability of components for their purposes. Customers should validate and test their design implementation to confirm system functionality.

See application note: *Build High Density, High Refresh Rate, Multiplexing LED Panel with TLC59581*, [SLVA744](#) available on ti.com

11 Power Supply Recommendations

Decouple the V_{CC} power supply voltage by placing a 0.1- μ F ceramic capacitor close to VCC pin and GND plane. Depending on panel size, several electrolytic capacitors must be placed on the board equally distributed to get a well regulated LED supply voltage (VLED). VLED voltage ripple must be less than 5% of its nominal value. Furthermore, set the VLED voltage as calculated by equation:

$$V_{LED} > V_f + 0.4 \text{ V (10 mA constant current example)}$$

where

- V_f = maximum forward voltage of LED (3)

12 Layout

12.1 Layout Guidelines

1. Place the decoupling capacitor near the VCC pin and GND plane.
2. Place the current programming resistor R_{IREF} close to IREF pin and IREFGND pin.
3. Route the GND pattern as widely as possible for large GND currents. Maximum GND current is approximately 1.2 A.
4. Routing between the LED cathode side and the device OUTXn pin should be as short and straight as possible to reduce wire inductance.
5. The PowerPAD™ must be connected to GND plane because the pad is used as power ground pin internally, there is a large current flow through this pad when all channels turn on. Furthermore, this pad should be connected to a heat sink layer by thermal via to reduce device temperature. One suggested thermal via pattern is shown in the [Device Layout Example](#). For more information about suggested thermal via pattern and via size, see *PowerPAD Thermally Enhanced Package*, [SLMA002G](#).
6. MOSFETS must be placed in the in the middle of the board, which should be laid out as symmetrically as possible.

12.2 Layout Example

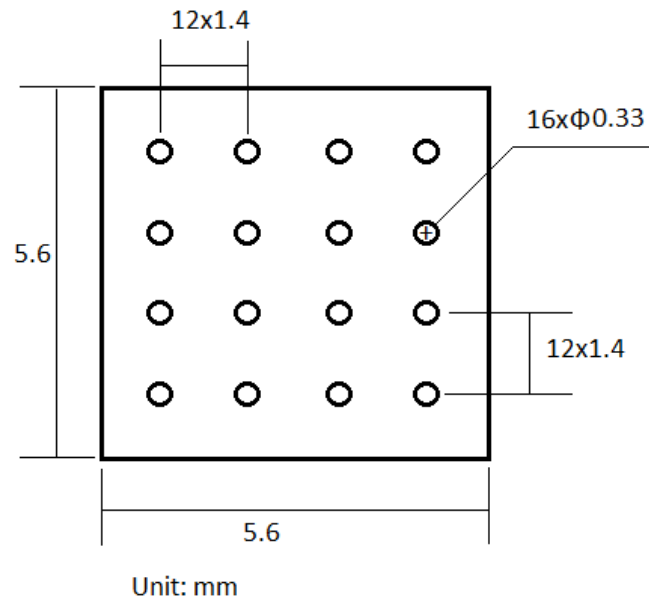

Figure 20. Device Layout Example

13 Device and Documentation Support

13.1 Documentation Support

13.1.1 Related Documentation

See these application reports for additional information:

PowerPAD Thermally Enhanced Package, [SLMA002G](#)

Semiconductor and IC Package Thermal Metrics, [SPRA953](#)

Build High Density, High Refresh Rate, Multiplexing LED Panel with TLC59581, [SLVA744](#)

13.2 Related Links

The table below lists quick access links. Categories include technical documents, support and community resources, tools and software, and quick access to sample or buy.

Table 3. Related Links

PARTS	PRODUCT FOLDER	SAMPLE & BUY	TECHNICAL DOCUMENTS	TOOLS & SOFTWARE	SUPPORT & COMMUNITY
TLC59581	Click here	Click here	Click here	Click here	Click here
TLC59582	Click here	Click here	Click here	Click here	Click here

13.3 Community Resources

The following links connect to TI community resources. Linked contents are provided "AS IS" by the respective contributors. They do not constitute TI specifications and do not necessarily reflect TI's views; see TI's [Terms of Use](#).

TI E2E™ Online Community *TI's Engineer-to-Engineer (E2E) Community*. Created to foster collaboration among engineers. At [e2e.ti.com](#), you can ask questions, share knowledge, explore ideas and help solve problems with fellow engineers.

Community Resources (continued)

Design Support *TI's Design Support* Quickly find helpful E2E forums along with design support tools and contact information for technical support.

13.4 Trademarks

PowerPAD, E2E are trademarks of Texas Instruments.
All other trademarks are the property of their respective owners.

13.5 Electrostatic Discharge Caution



These devices have limited built-in ESD protection. The leads should be shorted together or the device placed in conductive foam during storage or handling to prevent electrostatic damage to the MOS gates.

13.6 Glossary

[SLYZ022](#) — *TI Glossary*.

This glossary lists and explains terms, acronyms, and definitions.

14 Mechanical, Packaging, and Orderable Information

The following pages include mechanical, packaging, and orderable information. This information is the most current data available for the designated devices. This data is subject to change without notice and revision of this document. For browser-based versions of this data sheet, refer to the left-hand navigation.

PACKAGING INFORMATION

Orderable Device	Status (1)	Package Type	Package Drawing	Pins	Package Qty	Eco Plan (2)	Lead finish/ Ball material (6)	MSL Peak Temp (3)	Op Temp (°C)	Device Marking (4/5)	Samples
TLC59581RTQR	ACTIVE	QFN	RTQ	56	2000	RoHS & Green	NIPDAU NIPDAUAG	Level-3-260C-168 HR	-40 to 85	TLC59581AB	Samples
TLC59581RTQT	ACTIVE	QFN	RTQ	56	250	RoHS & Green	NIPDAU NIPDAUAG	Level-3-260C-168 HR	-40 to 85	TLC59581AB	Samples
TLC59582RTQR	ACTIVE	QFN	RTQ	56	2000	RoHS & Green	NIPDAU NIPDAUAG	Level-3-260C-168 HR	-40 to 85	59582	Samples
TLC59582RTQT	ACTIVE	QFN	RTQ	56	250	RoHS & Green	NIPDAU NIPDAUAG	Level-3-260C-168 HR	-40 to 85	59582	Samples

(1) The marketing status values are defined as follows:

ACTIVE: Product device recommended for new designs.

LIFEBUY: TI has announced that the device will be discontinued, and a lifetime-buy period is in effect.

NRND: Not recommended for new designs. Device is in production to support existing customers, but TI does not recommend using this part in a new design.

PREVIEW: Device has been announced but is not in production. Samples may or may not be available.

OBSOLETE: TI has discontinued the production of the device.

(2) **RoHS:** TI defines "RoHS" to mean semiconductor products that are compliant with the current EU RoHS requirements for all 10 RoHS substances, including the requirement that RoHS substance do not exceed 0.1% by weight in homogeneous materials. Where designed to be soldered at high temperatures, "RoHS" products are suitable for use in specified lead-free processes. TI may reference these types of products as "Pb-Free".

RoHS Exempt: TI defines "RoHS Exempt" to mean products that contain lead but are compliant with EU RoHS pursuant to a specific EU RoHS exemption.

Green: TI defines "Green" to mean the content of Chlorine (Cl) and Bromine (Br) based flame retardants meet JS709B low halogen requirements of <=1000ppm threshold. Antimony trioxide based flame retardants must also meet the <=1000ppm threshold requirement.

(3) MSL, Peak Temp. - The Moisture Sensitivity Level rating according to the JEDEC industry standard classifications, and peak solder temperature.

(4) There may be additional marking, which relates to the logo, the lot trace code information, or the environmental category on the device.

(5) Multiple Device Markings will be inside parentheses. Only one Device Marking contained in parentheses and separated by a "-" will appear on a device. If a line is indented then it is a continuation of the previous line and the two combined represent the entire Device Marking for that device.

(6) Lead finish/Ball material - Orderable Devices may have multiple material finish options. Finish options are separated by a vertical ruled line. Lead finish/Ball material values may wrap to two lines if the finish value exceeds the maximum column width.

Important Information and Disclaimer:The information provided on this page represents TI's knowledge and belief as of the date that it is provided. TI bases its knowledge and belief on information provided by third parties, and makes no representation or warranty as to the accuracy of such information. Efforts are underway to better integrate information from third parties. TI has taken and

continues to take reasonable steps to provide representative and accurate information but may not have conducted destructive testing or chemical analysis on incoming materials and chemicals. TI and TI suppliers consider certain information to be proprietary, and thus CAS numbers and other limited information may not be available for release.

In no event shall TI's liability arising out of such information exceed the total purchase price of the TI part(s) at issue in this document sold by TI to Customer on an annual basis.

GENERIC PACKAGE VIEW

RTQ 56

VQFN - 1 mm max height

8 x 8, 0.5 mm pitch

PLASTIC QUAD FLATPACK - NO LEAD

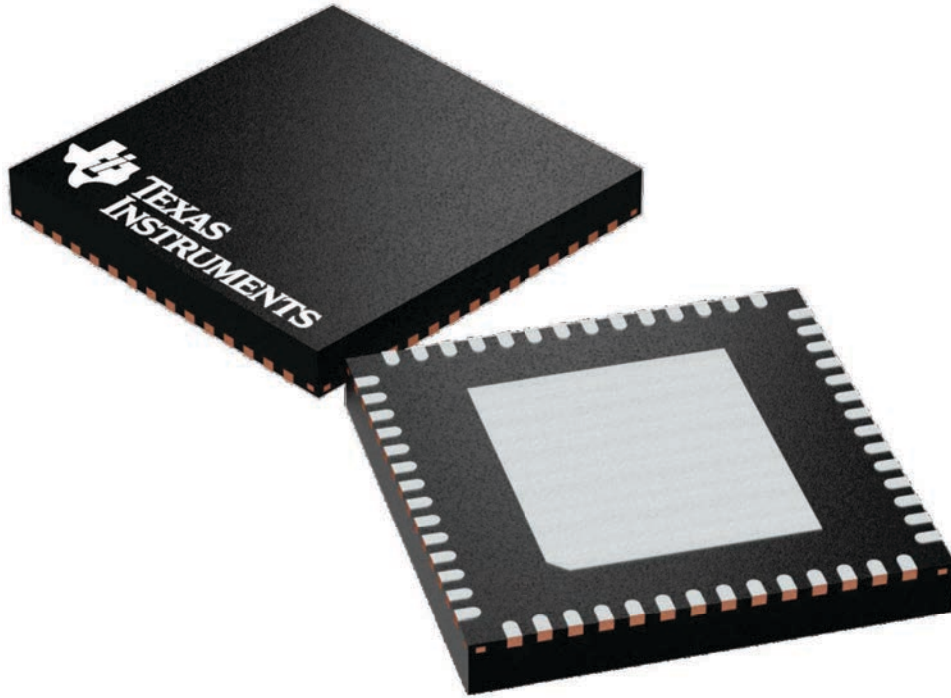

Images above are just a representation of the package family, actual package may vary.
Refer to the product data sheet for package details.

4224653/A

EXAMPLE BOARD LAYOUT

RTQ0056E

VQFN - 1 mm max height

PLASTIC QUAD FLATPACK - NO LEAD

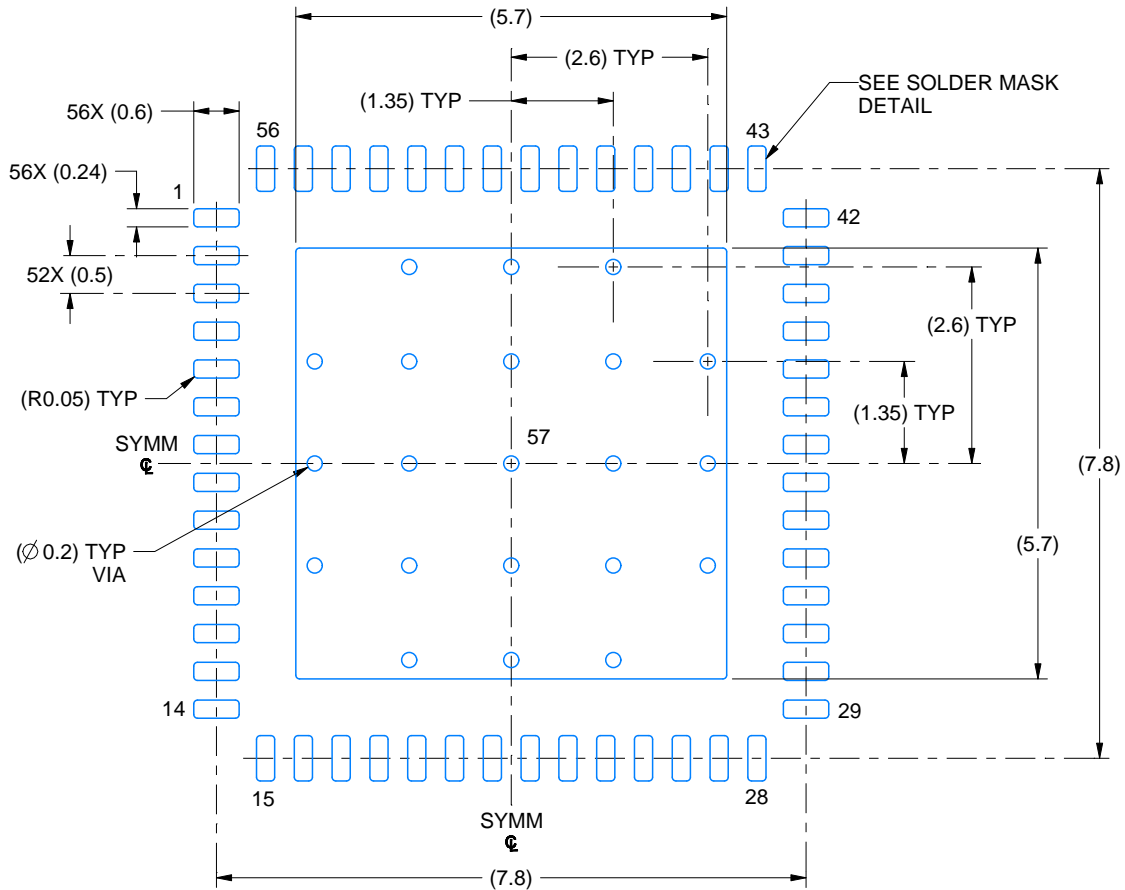

LAND PATTERN EXAMPLE
EXPOSED METAL SHOWN
SCALE: 10X

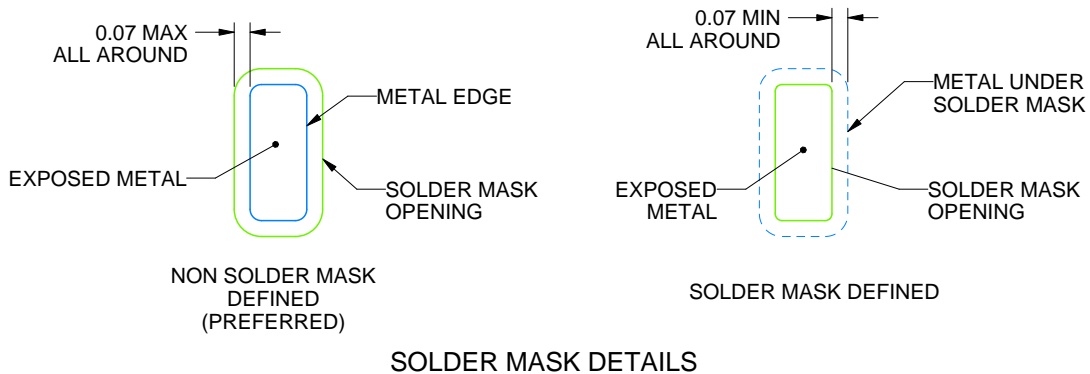

4224191/A 03/2018

NOTES: (continued)

4. This package is designed to be soldered to a thermal pad on the board. For more information, see Texas Instruments literature number SLUA271 (www.ti.com/lit/slua271).
5. Vias are optional depending on application, refer to device data sheet. If any vias are implemented, refer to their locations shown on this view. It is recommended that vias under paste be filled, plugged or tented.

EXAMPLE STENCIL DESIGN

RTQ0056E

VQFN - 1 mm max height

PLASTIC QUAD FLATPACK - NO LEAD

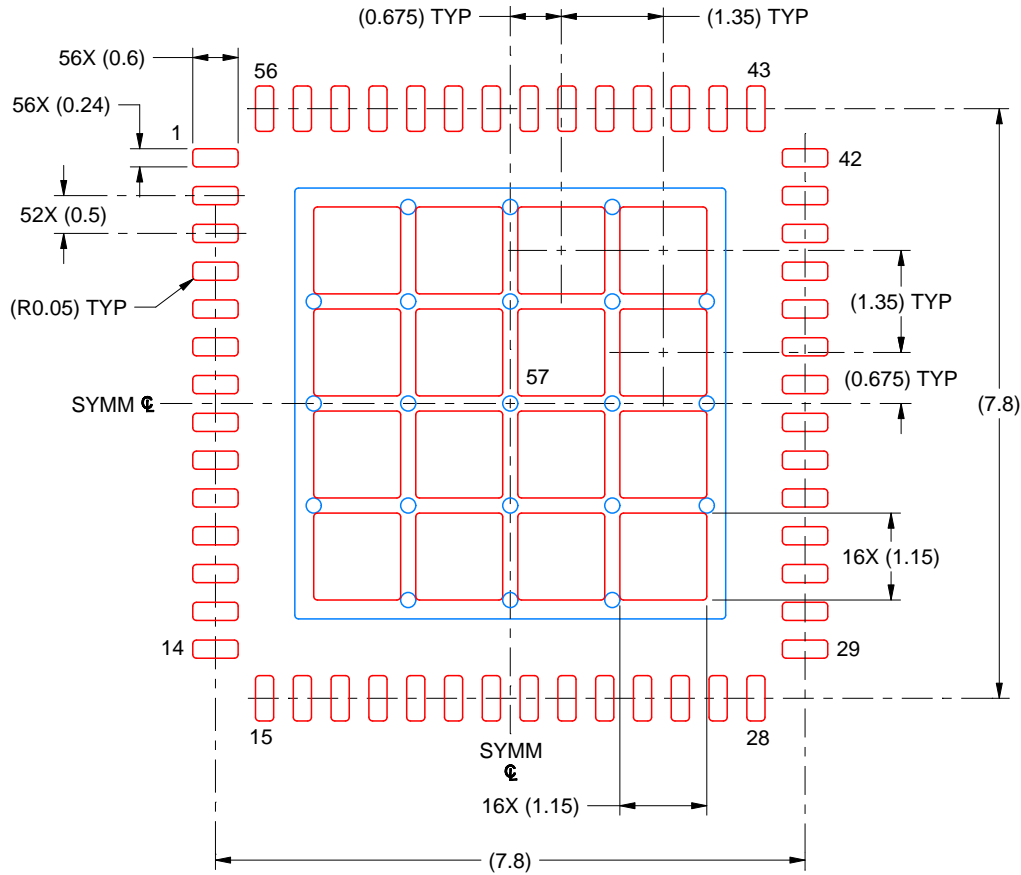

SOLDER PASTE EXAMPLE
BASED ON 0.125 MM THICK STENCIL
SCALE: 10X

EXPOSED PAD 57
65% PRINTED SOLDER COVERAGE BY AREA UNDER PACKAGE

4224191/A 03/2018

NOTES: (continued)

6. Laser cutting apertures with trapezoidal walls and rounded corners may offer better paste release. IPC-7525 may have alternate design recommendations.

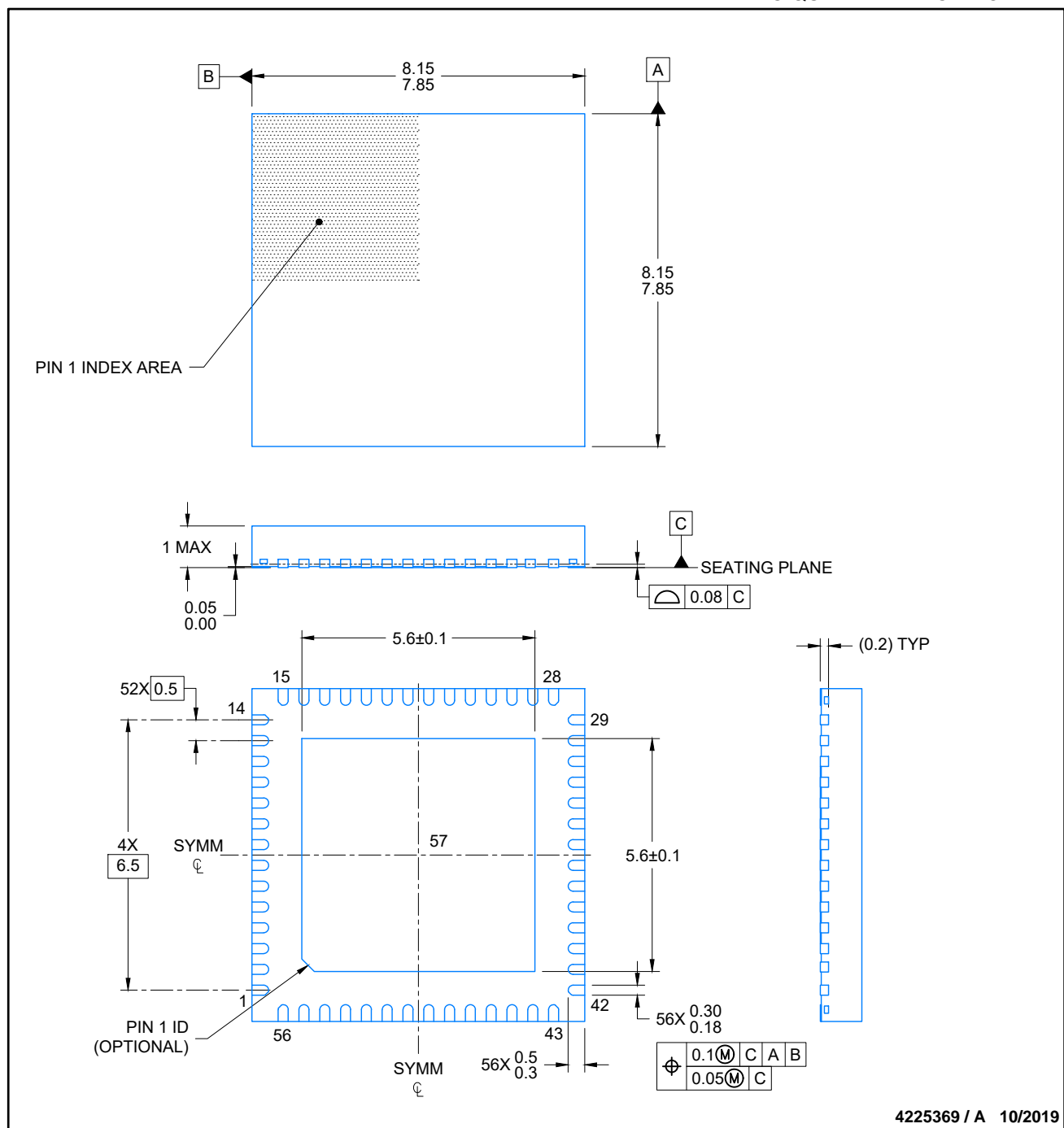

4225369 / A 10/2019

NOTES:

1. All linear dimensions are in millimeters. Any dimensions in parenthesis are for reference only. Dimensioning and tolerancing per ASME Y14.5M.
2. This drawing is subject to change without notice.
3. The package thermal pad must be soldered to the printed circuit board for thermal and mechanical performance.

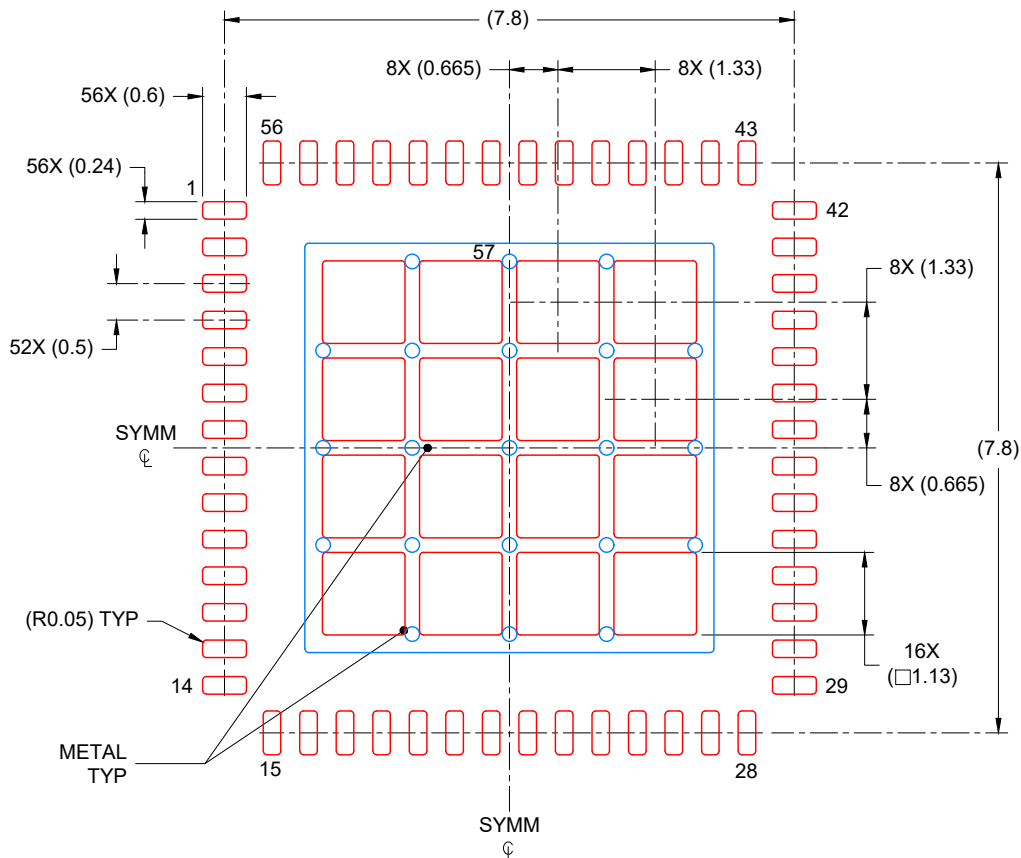

SOLDER PASTE EXAMPLE
 BASED ON 0.125 mm THICK STENCIL

EXPOSED PAD
 66% PRINTED COVERAGE BY AREA
 SCALE: 10X

4225369 / A 10/2019

NOTES: (continued)

6. Laser cutting apertures with trapezoidal walls and rounded corners may offer better paste release. IPC-7525 may have alternate design recommendations..

IMPORTANT NOTICE AND DISCLAIMER

TI PROVIDES TECHNICAL AND RELIABILITY DATA (INCLUDING DATASHEETS), DESIGN RESOURCES (INCLUDING REFERENCE DESIGNS), APPLICATION OR OTHER DESIGN ADVICE, WEB TOOLS, SAFETY INFORMATION, AND OTHER RESOURCES "AS IS" AND WITH ALL FAULTS, AND DISCLAIMS ALL WARRANTIES, EXPRESS AND IMPLIED, INCLUDING WITHOUT LIMITATION ANY IMPLIED WARRANTIES OF MERCHANTABILITY, FITNESS FOR A PARTICULAR PURPOSE OR NON-INFRINGEMENT OF THIRD PARTY INTELLECTUAL PROPERTY RIGHTS.

These resources are intended for skilled developers designing with TI products. You are solely responsible for (1) selecting the appropriate TI products for your application, (2) designing, validating and testing your application, and (3) ensuring your application meets applicable standards, and any other safety, security, or other requirements. These resources are subject to change without notice. TI grants you permission to use these resources only for development of an application that uses the TI products described in the resource. Other reproduction and display of these resources is prohibited. No license is granted to any other TI intellectual property right or to any third party intellectual property right. TI disclaims responsibility for, and you will fully indemnify TI and its representatives against, any claims, damages, costs, losses, and liabilities arising out of your use of these resources.

TI's products are provided subject to TI's Terms of Sale (www.ti.com/legal/termsofsale.html) or other applicable terms available either on ti.com or provided in conjunction with such TI products. TI's provision of these resources does not expand or otherwise alter TI's applicable warranties or warranty disclaimers for TI products.

Mailing Address: Texas Instruments, Post Office Box 655303, Dallas, Texas 75265
Copyright © 2020, Texas Instruments Incorporated

Looking for pricing, stock, or lifecycle information?

Click below to explore more details on WIN SOURCE:

 [View TLC59581RTQT on WIN SOURCE](#)

 [Texas Instruments](#) Information

Optimize Your Supply Chain with WIN SOURCE Solutions

-  Global Sourcing Solution
-  Obsolete Management
-  Cost Control Management
-  Shortage Management
-  Alternative Solution
-  Excess Inventory Management