



**THE DATASHEET OF
TISP4290F3DR-S**



TISP4240F3, TISP4260F3, TISP4290F3, TISP4320F3, TISP4380F3 SYMMETRICAL TRANSIENT VOLTAGE SUPPRESSORS

Copyright © 1997, Power Innovations Limited, UK

MARCH 1994 - REVISED SEPTEMBER 1997

TELECOMMUNICATION SYSTEM SECONDARY PROTECTION

- **Ion-Implanted Breakdown Region**
Precise and Stable Voltage
Low Voltage Overshoot under Surge

DEVICE	V _{DRM} V	V _(BO) V
'4240F3	180	240
'4260F3	200	260
'4290F3	220	290
'4320F3	240	320
'4380F3	270	380

- **Planar Passivated Junctions**
Low Off-State Current < 10 µA
- **Rated for International Surge Wave Shapes**

WAVE SHAPE	STANDARD	I _{TSP} A
2/10 µs	FCC Part 68	175
8/20 µs	ANSI C62.41	120
10/160 µs	FCC Part 68	60
10/560 µs	FCC Part 68	45
0.5/700 µs	RLM 88	38
10/700 µs	FTZ R12	50
	VDE 0433	50
	CCITT IX K17/K20	50
10/1000 µs	REA PE-60	35

- **Surface Mount and Through-Hole Options**

PACKAGE	PART # SUFFIX
Small-outline	D
Small-outline taped and reeled	DR
Single-in-line	SL

- **UL Recognized, E132482**

description

These high voltage symmetrical transient voltage suppressor devices are designed to protect two wire telecommunication applications against transients caused by lightning strikes and a.c. power lines. Offered in five voltage variants to meet battery and protection requirements they are guaranteed to suppress and withstand the listed international lightning surges in both polarities.

Transients are initially clipped by breakdown clamping until the voltage rises to the breakover

**D PACKAGE
(TOP VIEW)**

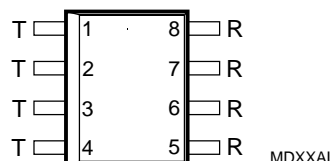

Specified ratings require the connection of pins 1, 2, 3 and 4 for the T terminal.

**SL PACKAGE
(TOP VIEW)**

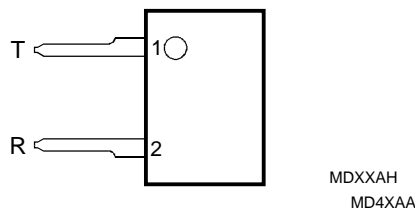

device symbol

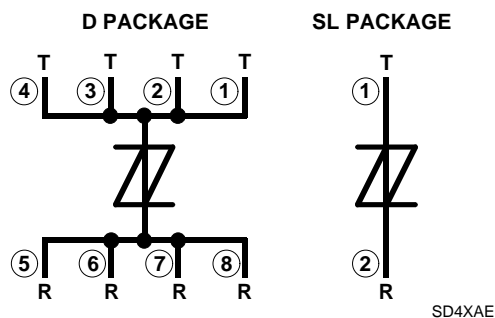

Terminals T and R correspond to the alternative line designators of A and B

level, which causes the device to crowbar. The high crowbar holding current prevents d.c. latchup as the current subsides.

These monolithic protection devices are fabricated in ion-implanted planar structures to ensure precise and matched breakover control and are virtually transparent to the system in normal operation

The small-outline 8-pin assignment has been carefully chosen for the TISP series to maximise the inter-pin clearance and creepage distances which are used by standards (e.g. IEC950) to establish voltage withstand ratings.

PRODUCT INFORMATION

Information is current as of publication date. Products conform to specifications in accordance with the terms of Power Innovations standard warranty. Production processing does not necessarily include testing of all parameters.



TISP4240F3, TISP4260F3, TISP4290F3, TISP4320F3, TISP4380F3 SYMMETRICAL TRANSIENT VOLTAGE SUPPRESSORS

MARCH 1994 - REVISED SEPTEMBER 1997

absolute maximum ratings

RATING		SYMBOL	VALUE	UNIT
Repetitive peak off-state voltage ($0^{\circ}\text{C} < T_J < 70^{\circ}\text{C}$)	'4240F3	V_{DRM}	± 180	V
	'4260F3		± 200	
	'4290F3		± 220	
	'4320F3		± 240	
	'4380F3		± 270	
Non-repetitive peak on-state pulse current (see Notes 1, 2 and 3)		I_{TSP}	A	A
1/2 μs (Gas tube differential transient, open-circuit voltage wave shape 1/2 μs)				
2/10 μs (FCC Part 68, open-circuit voltage wave shape 2/10 μs)				
8/20 μs (ANSI C62.41, open-circuit voltage wave shape 1.2/50 μs)				
10/160 μs (FCC Part 68, open-circuit voltage wave shape 10/160 μs)				
5/200 μs (VDE 0433, open-circuit voltage wave shape 2 kV, 10/700 μs)				
0.2/310 μs (RLM 88, open-circuit voltage wave shape 1.5 kV, 0.5/700 μs)				
5/310 μs (CCITT IX K17/K20, open-circuit voltage wave shape 2 kV, 10/700 μs)				
5/310 μs (FTZ R12, open-circuit voltage wave shape 2 kV, 10/700 μs)				
10/560 μs (FCC Part 68, open-circuit voltage wave shape 10/560 μs)				
10/1000 μs (REA PE-60, open-circuit voltage wave shape 10/1000 μs)				
Non-repetitive peak on-state current (see Notes 2 and 3) 50 Hz, 1 s	D Package	I_{TSM}	4	A rms
	SL Package		6	
Initial rate of rise of on-state current, Linear current ramp, Maximum ramp value $< 38 \text{ A}$		di_T/dt	250	A/ μs
Junction temperature		T_J	-40 to +150	$^{\circ}\text{C}$
Storage temperature range		T_{stg}	-40 to +150	$^{\circ}\text{C}$

- NOTES: 1. Further details on surge wave shapes are contained in the Applications Information section.
 2. Initially the TISP must be in thermal equilibrium with $0^{\circ}\text{C} < T_J < 70^{\circ}\text{C}$. The surge may be repeated after the TISP returns to its initial conditions.
 3. Above 70°C , derate linearly to zero at 150°C lead temperature.

electrical characteristics for the T and R terminals, $T_J = 25^{\circ}\text{C}$

PARAMETER	TEST CONDITIONS	TISP4240F3			TISP4260F3			UNIT
		MIN	TYP	MAX	MIN	TYP	MAX	
I_{DRM} Repetitive peak off-state current	$V_D = \pm V_{\text{DRM}}$, $0^{\circ}\text{C} < T_J < 70^{\circ}\text{C}$			± 10			± 10	μA
$V_{(\text{BO})}$ Breakover voltage	$dv/dt = \pm 250 \text{ V/ms}$, $R_{\text{SOURCE}} = 300 \Omega$			± 240			± 260	V
$V_{(\text{BO})}$ Impulse breakover voltage	$dv/dt = \pm 1000 \text{ V}/\mu\text{s}$, $R_{\text{SOURCE}} = 50 \Omega$, $di/dt < 20 \text{ A}/\mu\text{s}$		± 267			± 287		V
$I_{(\text{BO})}$ Breakover current	$dv/dt = \pm 250 \text{ V/ms}$, $R_{\text{SOURCE}} = 300 \Omega$	± 0.15		± 0.6	± 0.15		± 0.6	A
V_T On-state voltage	$I_T = \pm 5 \text{ A}$, $t_W = 100 \mu\text{s}$			± 3			± 3	V
I_H Holding current	$di/dt = +/- 30 \text{ mA/ms}$	± 0.15			± 0.15			A
dv/dt Critical rate of rise of off-state voltage	Linear voltage ramp Maximum ramp value $< 0.85V_{(\text{BR})\text{MIN}}$	± 5			± 5			kV/ μs
I_D Off-state current	$V_D = \pm 50 \text{ V}$			± 10			± 10	μA
C_{off} Off-state capacitance	$f = 100 \text{ kHz}$, $V_d = 100 \text{ mV}$ (see Note 4)	$V_D = 0$,		57	95	57	95	pF
		$V_D = -5 \text{ V}$		26	45	26	45	pF
		$V_D = -50 \text{ V}$		11	20	11	20	pF

NOTE 4: Further details on capacitance are given in the Applications Information section.

TISP4240F3, TISP4260F3, TISP4290F3, TISP4320F3, TISP4380F3
SYMMETRICAL TRANSIENT
VOLTAGE SUPPRESSORS

MARCH 1994 - REVISED SEPTEMBER 1997

electrical characteristics for the T and R terminals, $T_J = 25^\circ\text{C}$

PARAMETER	TEST CONDITIONS	TISP4290F3			TISP4320F3			UNIT
		MIN	TYP	MAX	MIN	TYP	MAX	
I_{DRM}	Repetitive peak off-state current $V_D = \pm V_{\text{DRM}}, 0^\circ\text{C} < T_J < 70^\circ\text{C}$			± 10			± 10	μA
$V_{(\text{BO})}$	Breakover voltage $dv/dt = \pm 250 \text{ V/ms}, R_{\text{SOURCE}} = 300 \Omega$			± 290			± 320	V
$V_{(\text{BO})}$	Impulse breakover voltage $dv/dt = \pm 1000 \text{ V}/\mu\text{s}, R_{\text{SOURCE}} = 50 \Omega,$ $di/dt < 20 \text{ A}/\mu\text{s}$		± 317			± 347		V
$I_{(\text{BO})}$	Breakover current $dv/dt = \pm 250 \text{ V/ms}, R_{\text{SOURCE}} = 300 \Omega$	± 0.15		± 0.6	± 0.15		± 0.6	A
V_T	On-state voltage $I_T = \pm 5 \text{ A}, t_W = 100 \mu\text{s}$			± 3			± 3	V
I_H	Holding current $di/dt = +/- 30 \text{ mA/ms}$	± 0.15			± 0.15			
dv/dt	Critical rate of rise of off-state voltage Linear voltage ramp Maximum ramp value $< 0.85V_{(\text{BR})\text{MIN}}$	± 5			± 5			$\text{kV}/\mu\text{s}$
I_D	Off-state current $V_D = \pm 50 \text{ V}$			± 10			± 10	μA
C_{off}	Off-state capacitance $f = 100 \text{ kHz}, V_d = 100 \text{ mV}$ (see Note 5)	$V_D = 0,$	57	95	57	95		pF
		$V_D = -5 \text{ V}$	26	45	26	45		pF
		$V_D = -50 \text{ V}$	11	20	11	20		pF

NOTE 5: Further details on capacitance are given in the Applications Information section.

electrical characteristics for the T and R terminals, $T_J = 25^\circ\text{C}$

PARAMETER	TEST CONDITIONS	TISP4380F3			UNIT	
		MIN	TYP	MAX		
I_{DRM}	Repetitive peak off-state current $V_D = \pm V_{\text{DRM}}, 0^\circ\text{C} < T_J < 70^\circ\text{C}$			± 10	μA	
$V_{(\text{BO})}$	Breakover voltage $dv/dt = \pm 250 \text{ V/ms}, R_{\text{SOURCE}} = 300 \Omega$			± 380	V	
$V_{(\text{BO})}$	Impulse breakover voltage $dv/dt = \pm 1000 \text{ V}/\mu\text{s}, R_{\text{SOURCE}} = 50 \Omega,$ $di/dt < 20 \text{ A}/\mu\text{s}$		± 407		V	
$I_{(\text{BO})}$	Breakover current $dv/dt = \pm 250 \text{ V/ms}, R_{\text{SOURCE}} = 300 \Omega$	± 0.15		± 0.6	A	
V_T	On-state voltage $I_T = \pm 5 \text{ A}, t_W = 100 \mu\text{s}$			± 3	V	
I_H	Holding current $di/dt = +/- 30 \text{ mA/ms}$	± 0.15			A	
dv/dt	Critical rate of rise of off-state voltage Linear voltage ramp Maximum ramp value $< 0.85V_{(\text{BR})\text{MIN}}$	± 5			$\text{kV}/\mu\text{s}$	
I_D	Off-state current $V_D = \pm 50 \text{ V}$			± 10	μA	
C_{off}	Off-state capacitance $f = 100 \text{ kHz}, V_d = 100 \text{ mV}$ (see Note 6)	$V_D = 0,$	57	95		pF
		$V_D = -5 \text{ V}$	26	45		pF
		$V_D = -50 \text{ V}$	11	20		pF

NOTE 6: Further details on capacitance are given in the Applications Information section.

thermal characteristics

PARAMETER	TEST CONDITIONS	MIN	TYP	MAX	UNIT
$R_{\theta\text{JA}}$	Junction to free air thermal resistance $P_{\text{tot}} = 0.8 \text{ W}, T_A = 25^\circ\text{C}$ $5 \text{ cm}^2, \text{FR4 PCB}$	D Package		160	$^\circ\text{C}/\text{W}$
		SL Package		105	

TISP4240F3, TISP4260F3, TISP4290F3, TISP4320F3, TISP4380F3
 SYMMETRICAL TRANSIENT
 VOLTAGE SUPPRESSORS

MARCH 1994 - REVISED SEPTEMBER 1997

PARAMETER MEASUREMENT INFORMATION

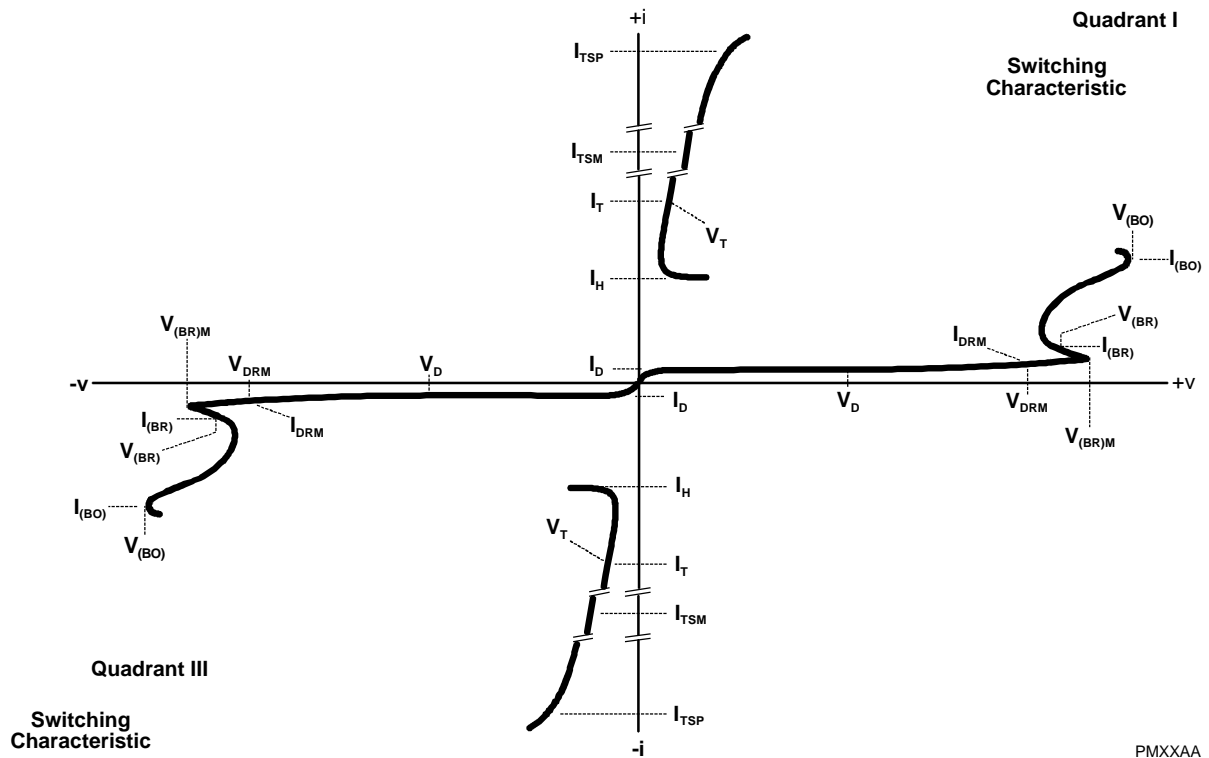

Figure 1. VOLTAGE-CURRENT CHARACTERISTIC FOR T AND R TERMINALS
 ALL MEASUREMENTS ARE REFERENCED TO THE R TERMINAL

PMXXAA

TYPICAL CHARACTERISTICS
R and T terminals

**OFF-STATE CURRENT
 vs**

JUNCTION TEMPERATURE

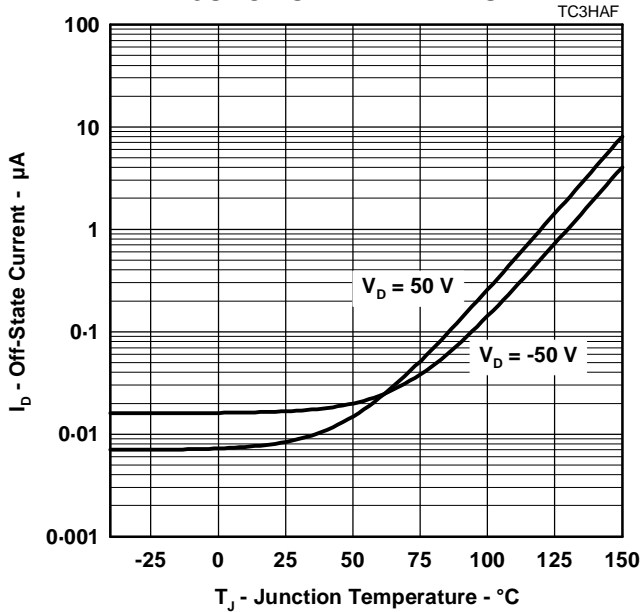

Figure 2.

**NORMALISED BREAKDOWN VOLTAGES
 vs**

JUNCTION TEMPERATURE

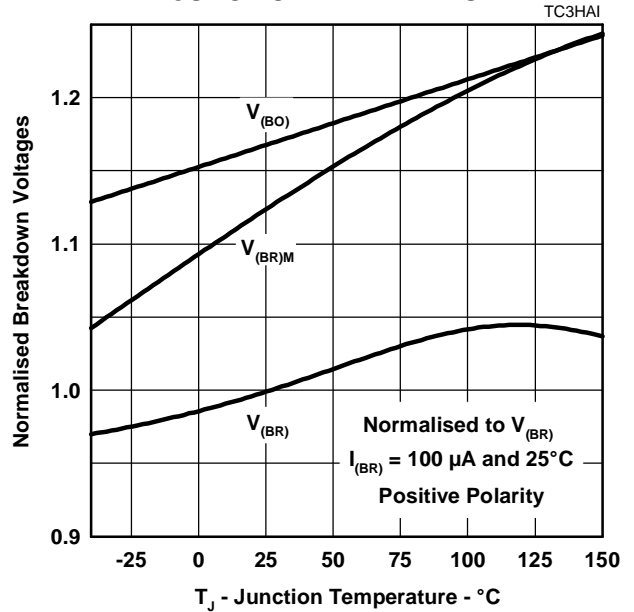

Figure 3.

**NORMALISED BREAKDOWN VOLTAGES
 vs**

JUNCTION TEMPERATURE

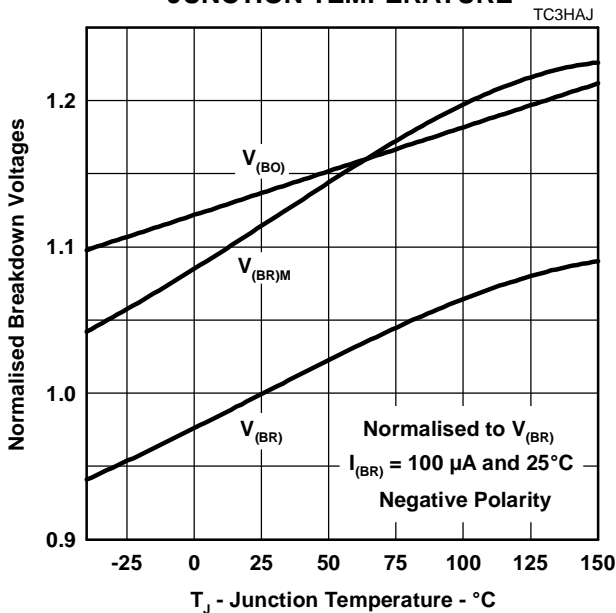

Figure 4.

**ON-STATE CURRENT
 vs**

ON-STATE VOLTAGE

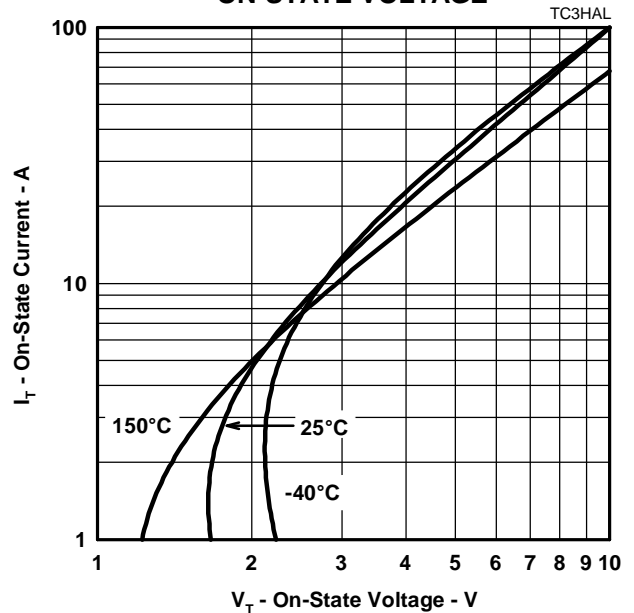

Figure 5.

TISP4240F3, TISP4260F3, TISP4290F3, TISP4320F3, TISP4380F3
**SYMMETRICAL TRANSIENT
 VOLTAGE SUPPRESSORS**

MARCH 1994 - REVISED SEPTEMBER 1997

**TYPICAL CHARACTERISTICS
 R and T terminals**

HOLDING CURRENT & BREAKOVER CURRENT

vs

JUNCTION TEMPERATURE

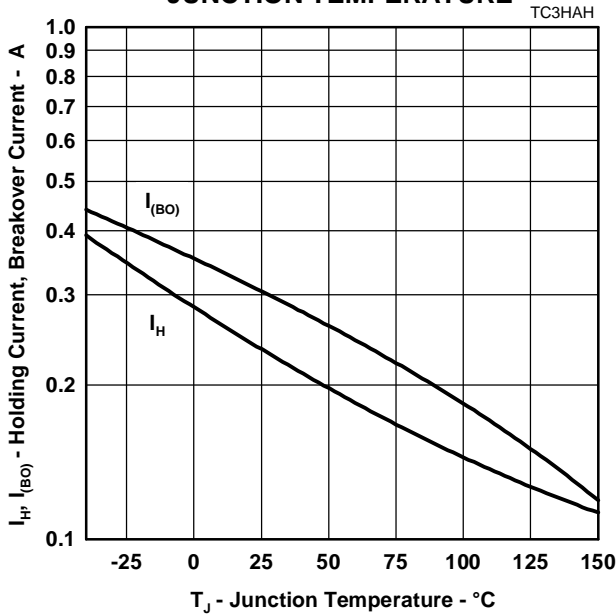

Figure 6.

NORMALISED BREAKOVER VOLTAGE

vs

RATE OF RISE OF PRINCIPLE CURRENT

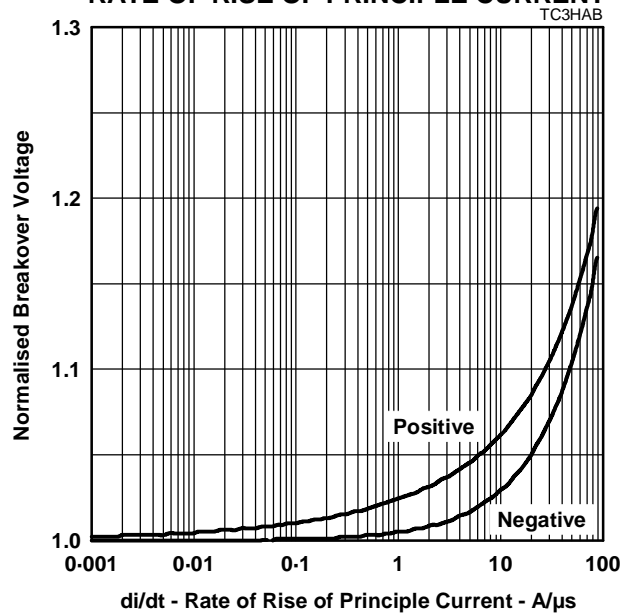

Figure 7.

OFF-STATE CAPACITANCE

vs

TERMINAL VOLTAGE

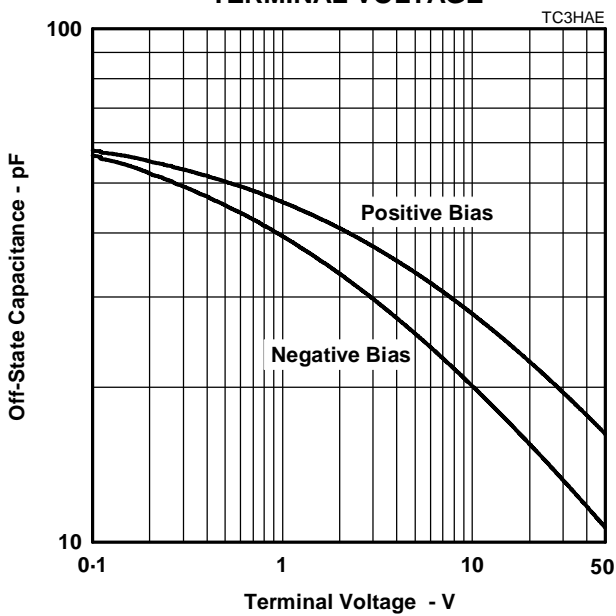

Figure 8.

OFF-STATE CAPACITANCE

vs

JUNCTION TEMPERATURE

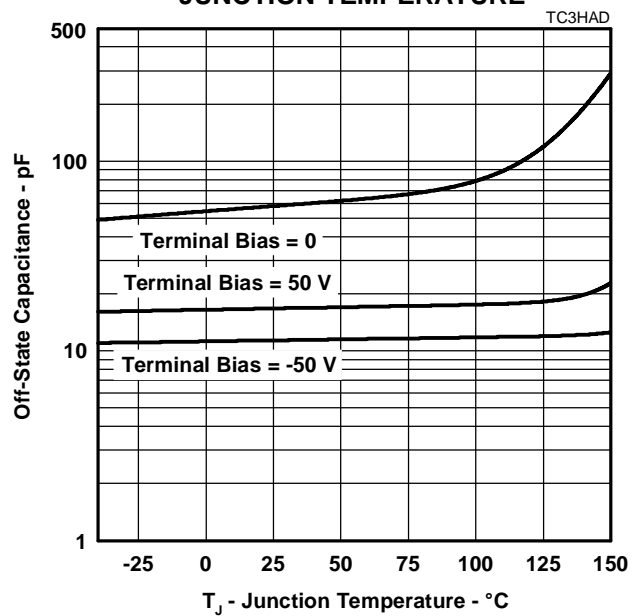

Figure 9.

TYPICAL CHARACTERISTICS
 R and T terminals

SURGE CURRENT

VS

DECAY TIME

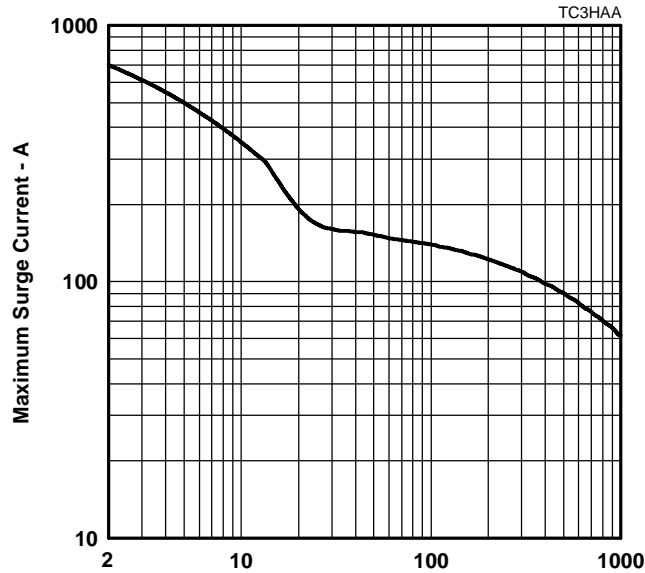

Decay Time - μs
 Figure 10.

THERMAL INFORMATION

MAXIMUM NON-RECURRING 50 Hz CURRENT

VS

CURRENT DURATION

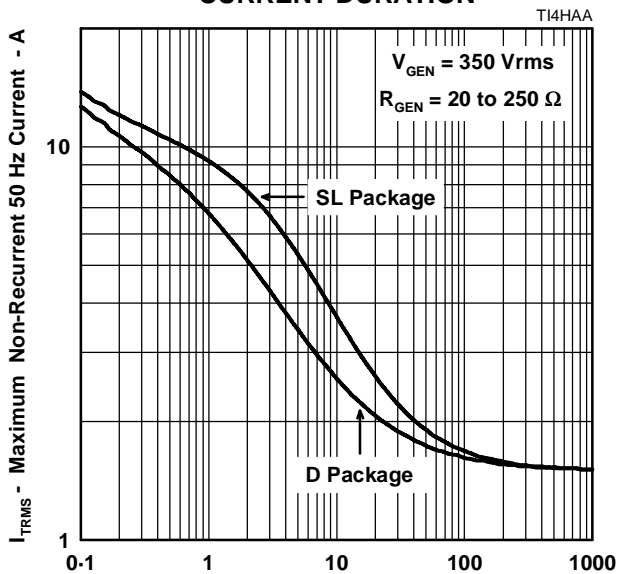

t - Current Duration - s
 Figure 11.

THERMAL RESPONSE

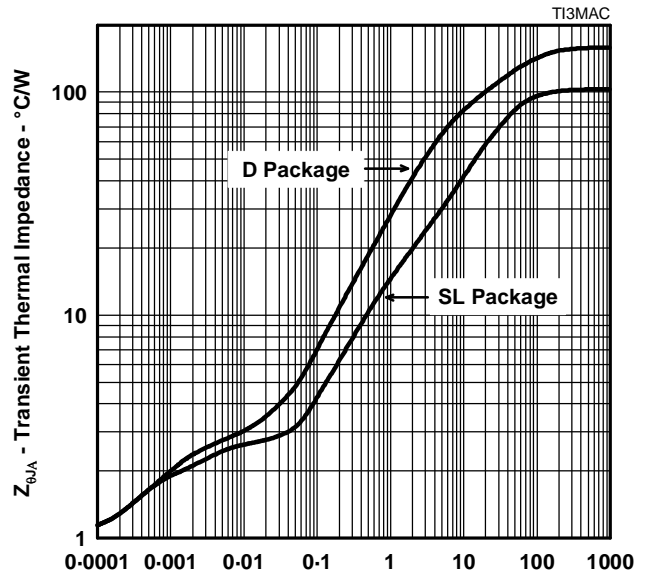

t - Power Pulse Duration - s
 Figure 12.

TISP4240F3, TISP4260F3, TISP4290F3, TISP4320F3, TISP4380F3 SYMMETRICAL TRANSIENT VOLTAGE SUPPRESSORS

MARCH 1994 - REVISED SEPTEMBER 1997

APPLICATIONS INFORMATION

electrical characteristics

The electrical characteristics of a TISP are strongly dependent on junction temperature, T_J . Hence a characteristic value will depend on the junction temperature at the instant of measurement. The values given in this data sheet were measured on commercial testers, which generally minimise the temperature rise caused by testing. Application values may be calculated from the parameters' temperature curves, the power dissipated and the thermal response curve (Z_{θ}).

lightning surge

wave shape notation

Most lightning tests, used for equipment verification, specify a unidirectional sawtooth waveform which has an exponential rise and an exponential decay. Wave shapes are classified in terms of peak amplitude (voltage or current), rise time and a decay time to 50% of the maximum amplitude. The notation used for the wave shape is *amplitude, rise time/decay time*. A 50A, 5/310 μ s wave shape would have a peak current value of 50 A, a rise time of 5 μ s and a decay time of 310 μ s. The TISP surge current graph comprehends the wave shapes of commonly used surges.

generators

There are three categories of surge generator type, single wave shape, combination wave shape and circuit defined. Single wave shape generators have essentially the same wave shape for the open circuit voltage and short circuit current (e.g. 10/1000 μ s open circuit voltage and short circuit current). Combination generators have two wave shapes, one for the open circuit voltage and the other for the short circuit current (e.g. 1.2/50 μ s open circuit voltage and 8/20 μ s short circuit current) Circuit specified generators usually equate to a combination generator, although typically only the open circuit voltage waveshape is referenced (e.g. a 10/700 μ s open circuit voltage generator typically produces a 5/310 μ s short circuit current). If the combination or circuit defined generators operate into a finite resistance the wave shape produced is intermediate between the open circuit and short circuit values.

current rating

When the TISP switches into the on-state it has a very low impedance. As a result, although the surge wave shape may be defined in terms of open circuit voltage, it is the current wave shape that must be used to assess the required TISP surge capability. As an example, the CCITT IX K17 1.5 kV, 10/700 μ s surge is changed to a 38 A, 5/310 μ s waveshape when driving into a short circuit. Thus the TISP surge current capability, when directly connected to the generator, will be found for the CCITT IX K17 waveform at 310 μ s on the surge graph and not 700 μ s. Some common short circuit equivalents are tabulated below:

STANDARD	OPEN CIRCUIT VOLTAGE	SHORT CIRCUIT CURRENT
CCITT IX K17	1.5 kV, 10/700 μ s	38 A, 5/310 μ s
CCITT IX K20	1 kV, 10/700 μ s	25 A, 5/310 μ s
RLM88	1.5 kV, 0.5/700 μ s	38 A, 0.2/310 μ s
VDE 0433	2.0 kV, 10/700 μ s	50 A, 5/200 μ s
FTZ R12	2.0 kV, 10/700 μ s	50 A, 5/310 μ s

Any series resistance in the protected equipment will reduce the peak circuit current to less than the generators' short circuit value. A 2 kV open circuit voltage, 50 A short circuit current generator has an effective output impedance of 40 Ω (2000/50). If the equipment has a series resistance of 25 Ω then the surge current requirement of the TISP becomes 31 A (2000/65) and not 50 A.

PRODUCT INFORMATION

APPLICATIONS INFORMATION

protection voltage

The protection voltage, ($V_{(BO)}$), increases under lightning surge conditions due to thyristor regeneration. This increase is dependent on the rate of current rise, di/dt , when the TISP is clamping the voltage in its breakdown region. The $V_{(BO)}$ value under surge conditions can be estimated by multiplying the 50 Hz rate $V_{(BO)}$ (250 V/ms) value by the normalised increase at the surge's di/dt (Figure 7.) . An estimate of the di/dt can be made from the surge generator voltage rate of rise, dv/dt , and the circuit resistance.

As an example, the CCITT IX K17 1.5 kV, 10/700 μ s surge has an average dv/dt of 150 V/ μ s, but, as the rise is exponential, the initial dv/dt is higher, being in the region of 450 V/ μ s. The instantaneous generator output resistance is 25 Ω . If the equipment has an additional series resistance of 20 Ω , the total series resistance becomes 45 Ω . The maximum di/dt then can be estimated as 450/45 = 10 A/ μ s. In practice the measured di/dt and protection voltage increase will be lower due to inductive effects and the finite slope resistance of the TISP breakdown region.

capacitance

off-state capacitance

The off-state capacitance of a TISP is sensitive to junction temperature, T_J , and the bias voltage, comprising of the dc voltage, V_D , and the ac voltage, V_d . All the capacitance values in this data sheet are measured with an ac voltage of 100 mV. The typical 25°C variation of capacitance value with ac bias is shown in Figure 13 When $V_D \gg V_d$ the capacitance value is independent on the value of V_d . The capacitance is essentially constant over the range of normal telecommunication frequencies.

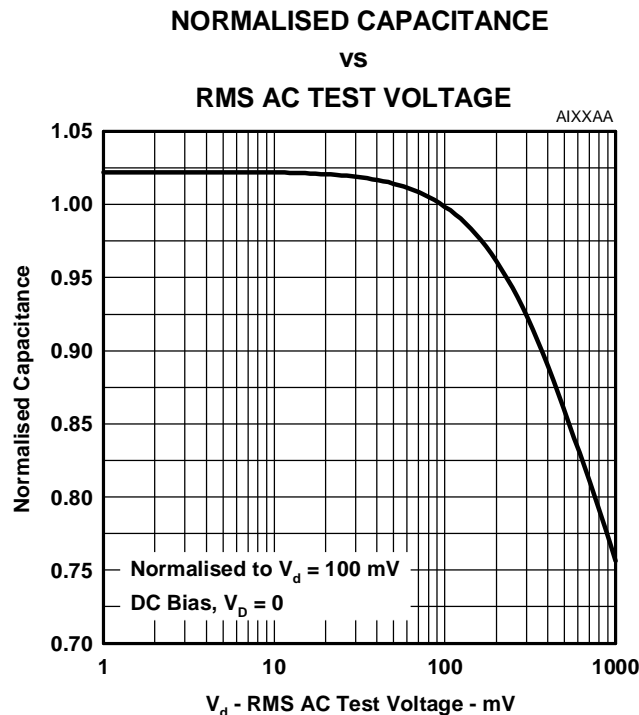

Figure 13.

TISP4240F3, TISP4260F3, TISP4290F3, TISP4320F3, TISP4380F3
**SYMMETRICAL TRANSIENT
 VOLTAGE SUPPRESSORS**

MARCH 1994 - REVISED SEPTEMBER 1997

MECHANICAL DATA

D008

plastic small-outline package

This small-outline package consists of a circuit mounted on a lead frame and encapsulated within a plastic compound. The compound will withstand soldering temperature with no deformation, and circuit performance characteristics will remain stable when operated in high humidity conditions. Leads require no additional cleaning or processing when used in soldered assembly.

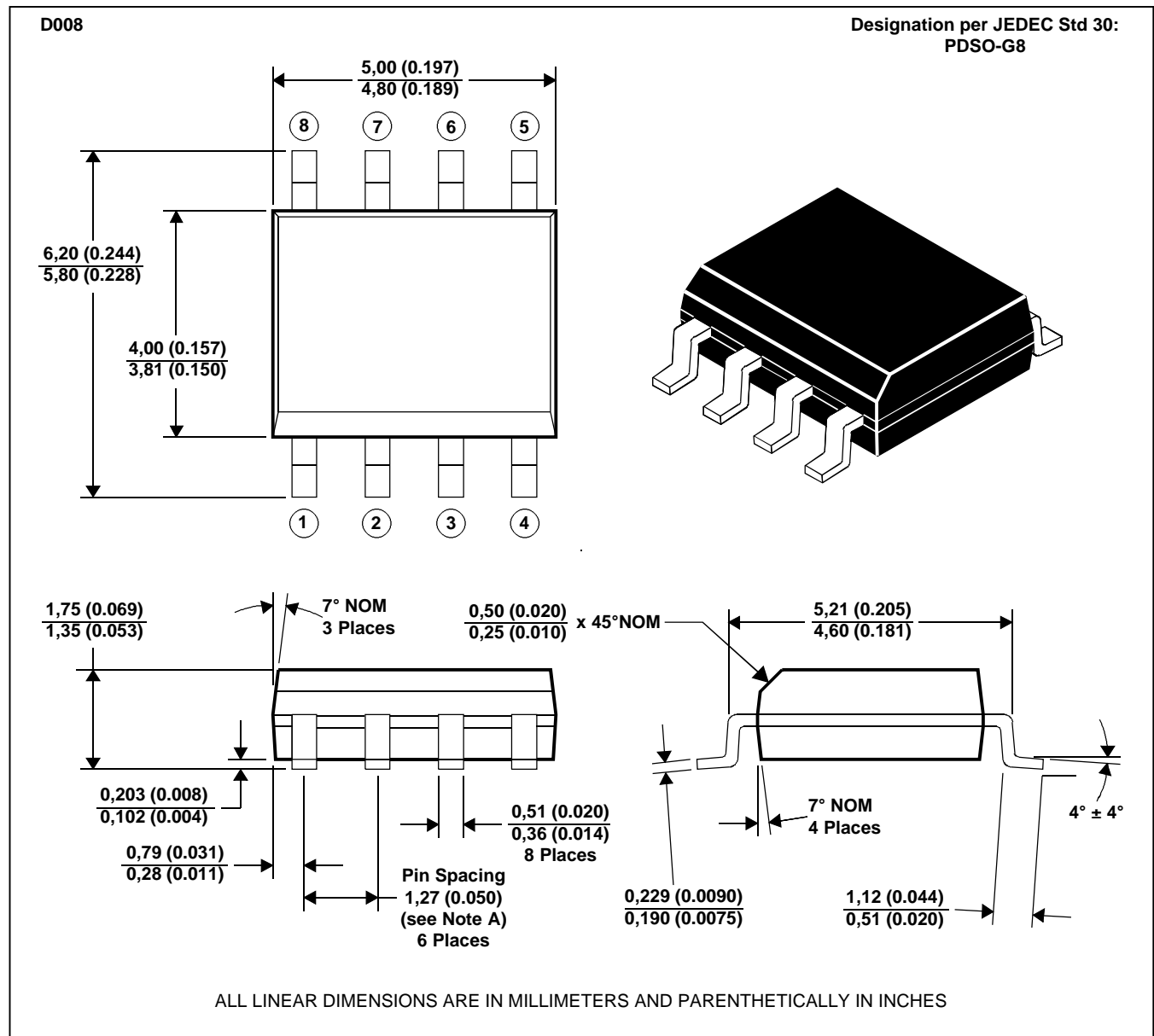

- NOTES: A. Leads are within 0,25 (0.010) radius of true position at maximum material condition.
 B. Body dimensions do not include mold flash or protrusion.
 C. Mold flash or protrusion shall not exceed 0,15 (0.006).
 D. Lead tips to be planar within ±0,051 (0.002).

MDXXAA

PRODUCT INFORMATION

MECHANICAL DATA

SL002

2-pin plastic single-in-line package

This single-in-line package consists of a circuit mounted on a lead frame and encapsulated within a plastic compound. The compound will withstand soldering temperature with no deformation, and circuit performance characteristics will remain stable when operated in high humidity conditions. Leads require no additional cleaning or processing when used in soldered assembly.

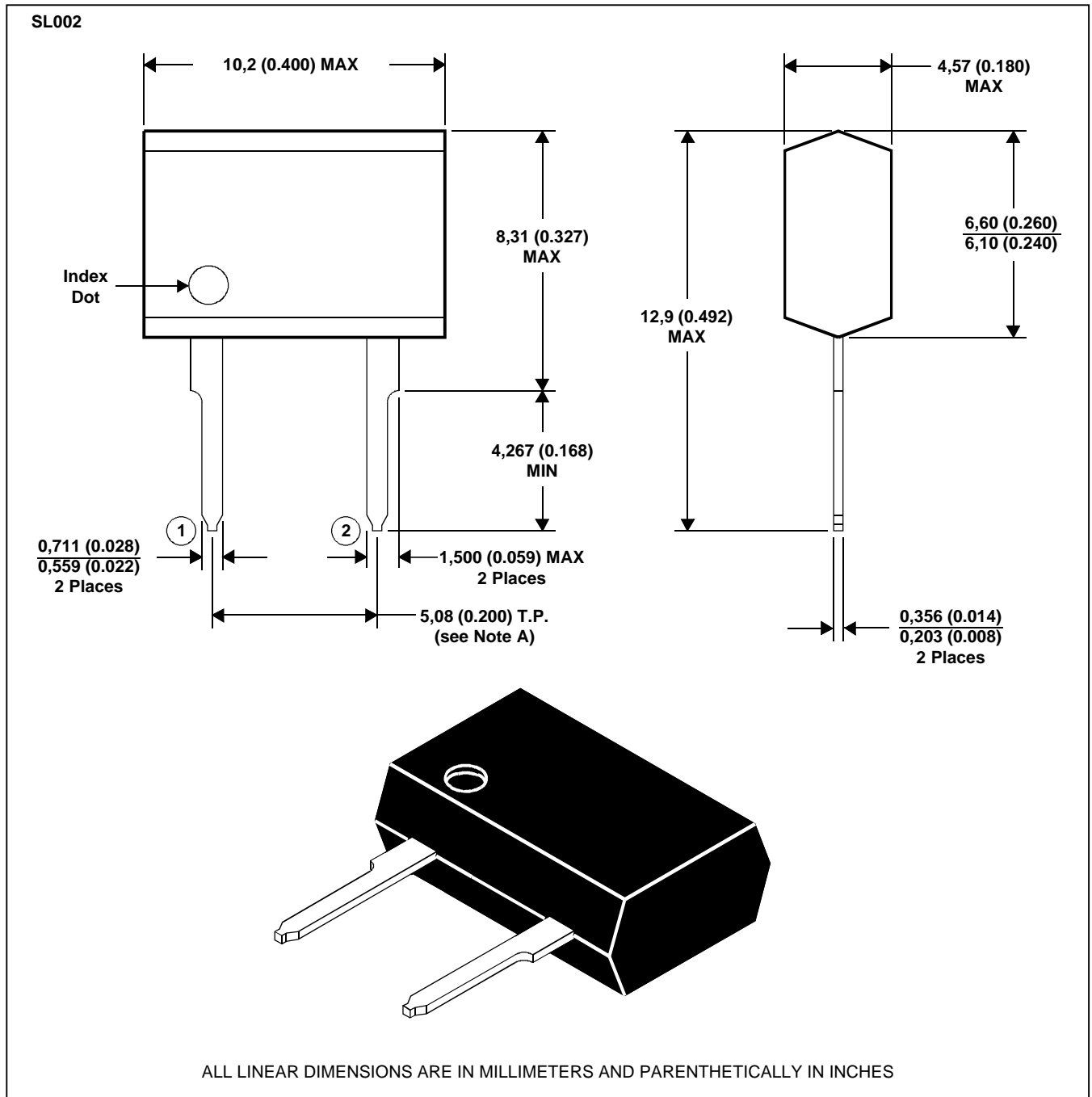

NOTES: A. Each pin centerline is located within 0,25 (0.010) of its true longitudinal position.
 B. Body molding flash of up to 0,15 (0.006) may occur in the package lead plane.

MDXXAC

TISP4240F3, TISP4260F3, TISP4290F3, TISP4320F3, TISP4380F3
**SYMMETRICAL TRANSIENT
 VOLTAGE SUPPRESSORS**

MARCH 1994 - REVISED SEPTEMBER 1997

MECHANICAL DATA

D008

tape dimensions

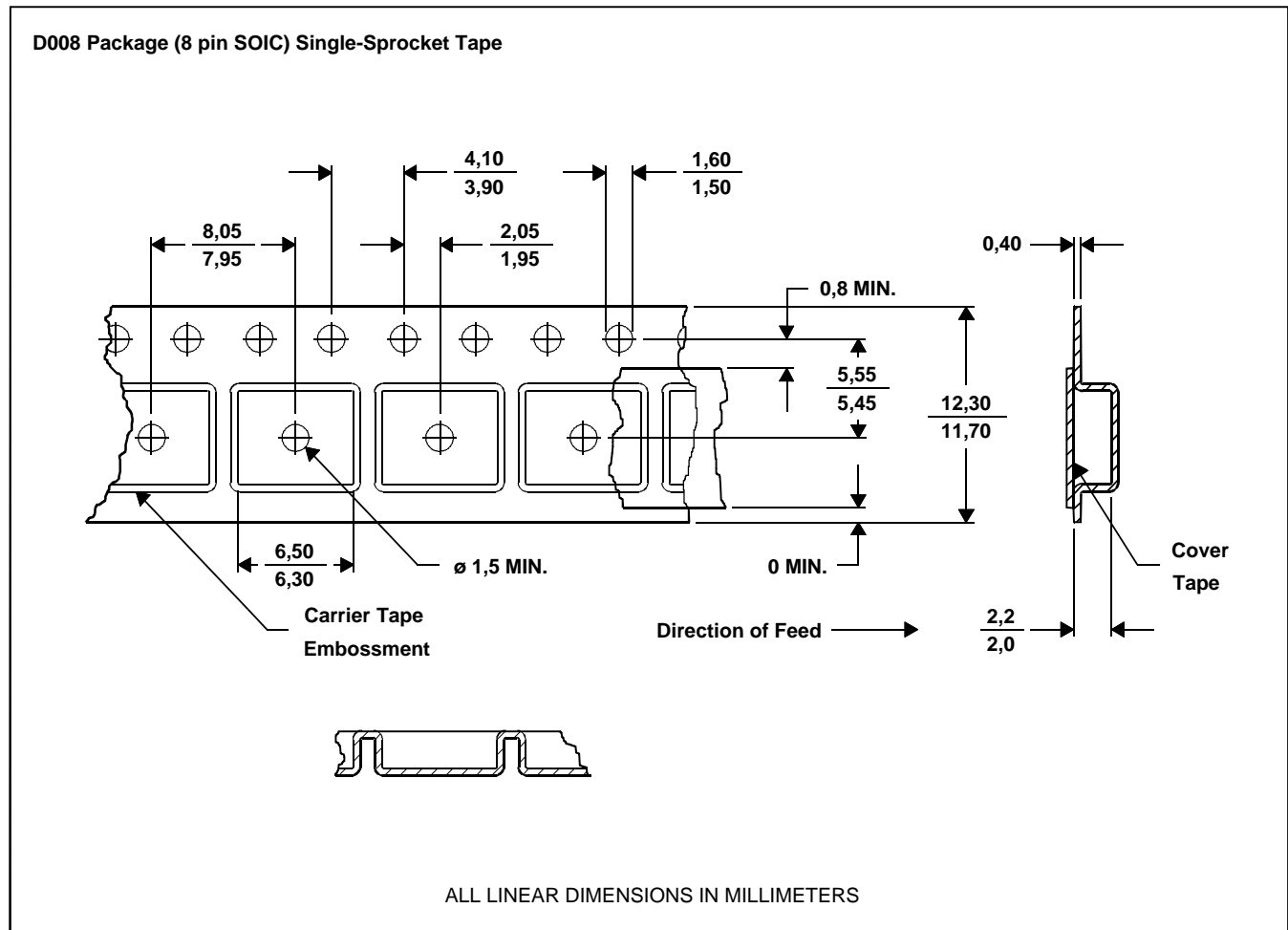

NOTES: A. Taped devices are supplied on a reel of the following dimensions:-

MDXXAT

Reel diameter: 330 +0,0/-4,0 mm
 Reel hub diameter: 100 ±2,0 mm
 Reel axial hole: 13,0 ±0,2 mm

B. 2500 devices are on a reel.

IMPORTANT NOTICE

Power Innovations Limited (PI) reserves the right to make changes to its products or to discontinue any semiconductor product or service without notice, and advises its customers to verify, before placing orders, that the information being relied on is current.

PI warrants performance of its semiconductor products to the specifications applicable at the time of sale in accordance with PI's standard warranty. Testing and other quality control techniques are utilized to the extent PI deems necessary to support this warranty. Specific testing of all parameters of each device is not necessarily performed, except as mandated by government requirements.



PI accepts no liability for applications assistance, customer product design, software performance, or infringement of patents or services described herein. Nor is any license, either express or implied, granted under any patent right, copyright, design right, or other intellectual property right of PI covering or relating to any combination, machine, or process in which such semiconductor products or services might be or are used.

PI SEMICONDUCTOR PRODUCTS ARE NOT DESIGNED, INTENDED, AUTHORIZED, OR WARRANTED TO BE SUITABLE FOR USE IN LIFE-SUPPORT APPLICATIONS, DEVICES OR SYSTEMS.

Copyright © 1997, Power Innovations Limited

Looking for pricing, stock, or lifecycle information?

Click below to explore more details on WIN SOURCE:

-  [View TISP4290F3DR-S on WIN SOURCE](#)
-  [Bourns Inc. Information](#)

Optimize Your Supply Chain with WIN SOURCE Solutions

-  Global Sourcing Solution
-  Obsolete Management
-  Cost Control Management
-  Shortage Management
-  Alternative Solution
-  Excess Inventory Management