

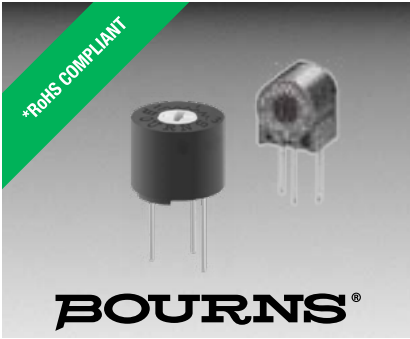

**THE DATASHEET OF
PV12T101A01B00**





Features

- Multiturn / Cermet / Sealed
- Available in both top and side adjustment
- Units can be pre-adjusted at clockwise, counter-clockwise or standard 50 % position
- RoHS compliant*
- For trimmer applications/processing guidelines, [click here](#)

PV12 Series – Lead Sealed Type Multiturn Trimming Potentiometer

Product Dimensions

PV12P – Top Adjustment

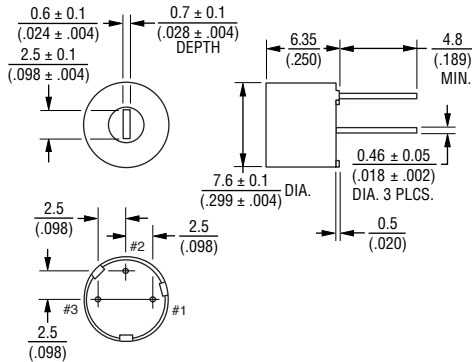

PV12T – Side Adjustment

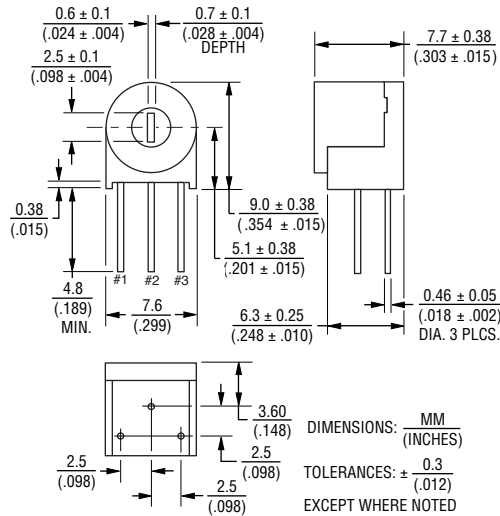

Additional Information

Click these links for more information:



Environmental Characteristics

Temperature Cycle

Δ TR ± 2 %
 Δ V.S.S. ± 1 %

Humidity

..... ± 2 % Δ TR; 100 megohms IR min.
Vibration ... 20 G (1 % Δ TR; 1 % Δ V.S.S.)
Shock..... 100 G (1 % Δ TR; 1 % Δ V.S.S.)

Temperature Load Life

..... 3 % Δ TR; 2 % Δ V.S.S.

Low Temperature Exposure

..... 3 % Δ TR; 1.5 % Δ V.S.S.

High Temperature Exposure

..... 3 % Δ TR; 1.5 % Δ V.S.S.

Rotational Life.....200 cycles, Δ TR ± 3 %

Δ TR: Total Resistance Change
 Δ V.S.S.: Voltage Setting Stability
IR: Insulation Resistance

Recommended PCB Layout

PV12P

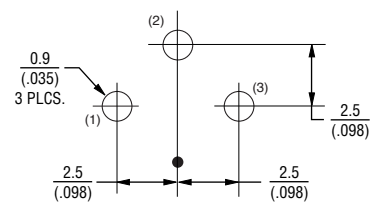

PV12T

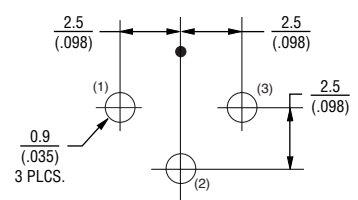

DIMENSIONS: $\frac{\text{MM}}{\text{(INCHES)}}$

TOLERANCES: $\pm \frac{0.1}{(0.004)}$ EXCEPT WHERE NOTED



WARNING Cancer and Reproductive Harm - www.P65Warnings.ca.gov

*RoHS Directive 2015/863, Mar 31, 2015 and Annex.

Specifications are subject to change without notice.

Users should verify actual device performance in their specific applications.

The products described herein and this document are subject to specific legal disclaimers as set forth on the last page of this document, and at www.bourns.com/docs/legal/disclaimer.pdf.

PV12 Series – Lead Sealed Type Multiturn Trimming Potentiometer **BOURNS®**

Electrical Characteristics

Model Number	Power Rating @ 70 °C (W)	Number of Turns (Effective Rotation Angle)	Total Resistance Value (Ω)	Resistance Tolerance	TCR (ppm/°C)
PV12x100A01B00	0.5	4	10	±10 %	±100
PV12x200A01B00			20		
PV12x500A01B00			50		
PV12x101A01B00			100		
PV12x201A01B00			200		
PV12x501A01B00			500		
PV12x102A01B00			1k		
PV12x202A01B00			2k		
PV12x502A01B00			5k		
PV12x103A01B00			10k		
PV12x203A01B00			20k		
PV12x253A01B00			25k		
PV12x503A01B00			50k		
PV12x104A01B00			100k		
PV12x204A01B00			200k		
PV12x254A01B00			250k		
PV12x504A01B00			500k		
PV12x105A01B00			1M		

Operating Temperature Range: -55 to +125 °C
“x” denotes Adjustment Direction (Top or Side)

Soldering Method: Wave (Single and Dual)

Typical Part Marking

3-Digit Date Code and Manufacturing Code

- First digit indicates year of manufacture;
- Last two digits indicate week of manufacture;
- 4th digit is suffix for manufacturing location:
C = Costa Rica

EX: 604C = Manufactured in 2016,
week 4, Costa Rica

Resistance Code

- Resistance code marking as shown in the Standard Resistance Table.

Schematic

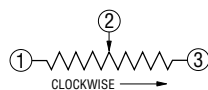

Specifications are subject to change without notice.

Users should verify actual device performance in their specific applications.

The products described herein and this document are subject to specific legal disclaimers as set forth on the last page of this document, and at www.bourns.com/docs/legal/disclaimer.pdf.

PV12 Series – Lead Sealed Type Multiturn Trimming Potentiometer **BOURNS®**

How To Order

PV 12 P 103 A01 B00

Product ID _____
 PV = Trimming Potentiometer

Series _____
 12 = Lead Sealed 7 mm Round 4-turns

Adjustment Direction/Lead Type _____
 P = Top, Triangle
 T = Side, Triangle

Resistance Code _____
 See Standard Resistance Table

Individual Specification _____
 A01 = Standard Type

Packaging _____
 B00 = Tube (50 pcs. per tube)

Standard Resistance Table

Resistance (Ohms)	Resistance Code
10	100
20	200
50	500
100	101
200	201
500	501
1,000	102
2,000	202
5,000	502
10,000	103
20,000	203
25,000	253
50,000	503
100,000	104
200,000	204
250,000	254
500,000	504
1,000,000	105

Popular distribution values listed in **boldface**.
 Special resistances available.

BOURNS®

Asia-Pacific: Tel: +886-2 2562-4117 • Email: asiacus@bourns.com

EMEA: Tel: +36 88 885 877 • Email: eurocus@bourns.com

The Americas: Tel: +1-951 781-5500 • Email: americus@bourns.com

www.bourns.com

REV. 08/19

Specifications are subject to change without notice.

Users should verify actual device performance in their specific applications.

The products described herein and this document are subject to specific legal disclaimers as set forth on the last page of this document, and at www.bourns.com/docs/legal/disclaimer.pdf.

This legal disclaimer applies to purchasers and users of Bourns® products manufactured by or on behalf of Bourns, Inc. and its affiliates (collectively, “Bourns”).

Unless otherwise expressly indicated in writing, Bourns® products and data sheets relating thereto are subject to change without notice. Users should check for and obtain the latest relevant information and verify that such information is current and complete before placing orders for Bourns® products.

The characteristics and parameters of a Bourns® product set forth in its data sheet are based on laboratory conditions, and statements regarding the suitability of products for certain types of applications are based on Bourns’ knowledge of typical requirements in generic applications. The characteristics and parameters of a Bourns® product in a user application may vary from the data sheet characteristics and parameters due to (i) the combination of the Bourns® product with other components in the user’s application, or (ii) the environment of the user application itself. The characteristics and parameters of a Bourns® product also can and do vary in different applications and actual performance may vary over time. Users should always verify the actual performance of the Bourns® product in their specific devices and applications, and make their own independent judgments regarding the amount of additional test margin to design into their device or application to compensate for differences between laboratory and real world conditions.

Unless Bourns has explicitly designated an individual Bourns® product as meeting the requirements of a particular industry standard (e.g., ISO/TS 16949) or a particular qualification (e.g., UL listed or recognized), Bourns is not responsible for any failure of an individual Bourns® product to meet the requirements of such industry standard or particular qualification. Users of Bourns® products are responsible for ensuring compliance with safety-related requirements and standards applicable to their devices or applications.

Bourns® products are not recommended, authorized or intended for use in nuclear, lifesaving, life-critical or life-sustaining applications, nor in any other applications where failure or malfunction may result in personal injury, death, or severe property or environmental damage. Unless expressly and specifically approved in writing by two authorized Bourns representatives on a case-by-case basis, use of any Bourns® products in such unauthorized applications might not be safe and thus is at the user’s sole risk. Life-critical applications include devices identified by the U.S. Food and Drug Administration as Class III devices and generally equivalent classifications outside of the United States.

Bourns expressly identifies those Bourns® standard products that are suitable for use in automotive applications on such products’ data sheets in the section entitled “Applications.” Unless expressly and specifically approved in writing by two authorized Bourns representatives on a case-by-case basis, use of any other Bourns® standard products in an automotive application might not be safe and thus is not recommended, authorized or intended and is at the user’s sole risk. If Bourns expressly identifies a sub-category of automotive application in the data sheet for its standard products (such as infotainment or lighting), such identification means that Bourns has reviewed its standard product and has determined that if such Bourns® standard product is considered for potential use in automotive applications, it should only be used in such sub-category of automotive applications. Any reference to Bourns® standard product in the data sheet as compliant with the AEC-Q standard or “automotive grade” does not by itself mean that Bourns has approved such product for use in an automotive application.

Bourns® standard products are not tested to comply with United States Federal Aviation Administration standards generally or any other generally equivalent governmental organization standard applicable to products designed or manufactured for use in aircraft or space applications. Bourns expressly identifies Bourns® standard products that are suitable for use in aircraft or space applications on such products’ data sheets in the section entitled “Applications.” Unless expressly and specifically approved in writing by two authorized Bourns representatives on a case-by-case basis, use of any other Bourns® standard product in an aircraft or space application might not be safe and thus is not recommended, authorized or intended and is at the user’s sole risk.

The use and level of testing applicable to Bourns® custom products shall be negotiated on a case-by-case basis by Bourns and the user for which such Bourns® custom products are specially designed. Absent a written agreement between Bourns and the user regarding the use and level of such testing, the above provisions applicable to Bourns® standard products shall also apply to such Bourns® custom products.

Users shall not sell, transfer, export or re-export any Bourns® products or technology for use in activities which involve the design, development, production, use or stockpiling of nuclear, chemical or biological weapons or missiles, nor shall they use Bourns® products or technology in any facility which engages in activities relating to such devices. The foregoing restrictions apply to all uses and applications that violate national or international prohibitions, including embargos or international regulations. Further, Bourns® products and Bourns technology and technical data may not under any circumstance be exported or re-exported to countries subject to international sanctions or embargoes. Bourns® products may not, without prior authorization from Bourns and/or the U.S. Government, be resold, transferred, or re-exported to any party not eligible to receive U.S. commodities, software, and technical data.

To the maximum extent permitted by applicable law, Bourns disclaims (i) any and all liability for special, punitive, consequential, incidental or indirect damages or lost revenues or lost profits, and (ii) any and all implied warranties, including implied warranties of fitness for particular purpose, non-infringement and merchantability.



For your convenience, copies of this Legal Disclaimer Notice with German, Spanish, Japanese, Traditional Chinese and Simplified Chinese bilingual versions are available at:

Web Page: <http://www.bourns.com/legal/disclaimers-terms-and-policies>

PDF: <http://www.bourns.com/docs/Legal/disclaimer.pdf>

Looking for pricing, stock, or lifecycle information?

Click below to explore more details on WIN SOURCE:

-  [View PV12T101A01B00 on WIN SOURCE](#)
-  [Bourns Inc. Information](#)

Optimize Your Supply Chain with WIN SOURCE Solutions

-  Global Sourcing Solution
-  Obsolete Management
-  Cost Control Management
-  Shortage Management
-  Alternative Solution
-  Excess Inventory Management