



**THE DATASHEET OF  
STA-6033Z**





Package: QFN, 16 pin, 3mm x 3mm



## Product Description

RFMD's STA-6033 is a high efficiency class AB Heterojunction Bipolar Transistor (HBT) amplifier housed in a low-cost surface-mountable plastic package. This HBT amplifier is made with InGaP on GaAs device technology and fabricated with MOCVD for an ideal combination of low cost and high reliability. This product is specifically designed as a final stage for 802.11a equipment in the 4.9GHz to 5.9GHz band. It can be run from a 3V to 6V supply. Optimized on-chip impedance matching circuitry provides a 50Ω nominal RF input impedance. A single external output allows for matching circuit covers the entire 4.9GHz to 5.9GHz band. The external output match allows for load line optimization for other applications or optimized for other applications or optimized performance over narrower bands. It is designed as a drop in replacement for similar parts in its class. This product is available in RoHS Compliant and Green package with matte tin finish, designated by the "Z" package suffix.

### Optimum Technology Matching® Applied

- GaAs HBT
- GaAs MESFET
- InGaP HBT
- SiGe BiCMOS
- Si BiCMOS
- SiGe HBT
- GaAs pHEMT
- Si CMOS
- Si BJT
- GaN HEMT
- RF MEMS

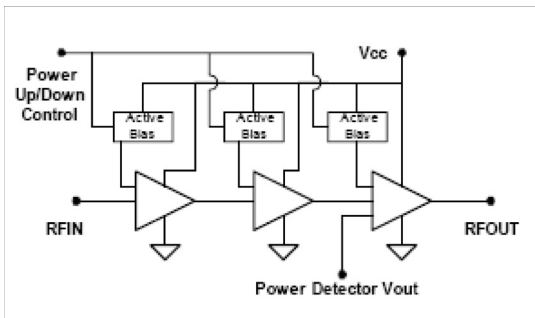

## Features

- 802.11a 54 Mb/s Class AB Performance
- $P_{OUT} = 18\text{ dBm}$  at 3% EVM, 3.3V, 210mA
- High Gain = 27 dB
- Output Return Loss < 12dB for Linear Tune
- On-Chip Output Power Detector
- Simultaneous 4.9GHz to 5.9GHz Broadband
- Robust - Survives RF Input Power = +20dBm
- Power Up/Down Control < 1μs

## Applications

- 802.11a WLAN, OFDM, 5.8GHz ISM Band
- 802.16 WiMax, Fixed Wireless, UNI

Parameter	Specification			Unit	Condition
	Min.	Typ.	Max.		
Frequency of Operation	4900		5900	MHz	
Output Power at 1dB Compression		26.5		dBm	4.9GHz
Gain	24.0	25.5		dBm	5.875GHz
	27.5	29.5	31.5	dB	4.9GHz
Output power	22.0	24.0	26.0	dB	5.875GHz
		18.0		dBm	5.15GHz, 3% EVM 802.11a 54Mb/s
		18.0		dBm	5.875GHz
Third Order Intermod		-38.0	-34.0	dBc	5.875MHz, $P_{OUT} = 15\text{ dBm}$ per tone
Noise Figure, (NF)		5.7		dB	5.875GHz
Worst Case Input Return Loss	11.0	15.0		dB	4.9GHz to 5.875GHz
Worst Case Output Return Loss	8.0	12.0		dB	4.9GHz to 5.875GHz
Output Voltage Range		0.8 to 1.5		V	$P_{OUT} = 7\text{ dBm}$ to 23dBm
$V_{CC}$ Quiescent Current	130	165	190	mA	
Power Up Control Current		1.5		mA	$V_{PC} = 3.3V$ ( $I_{VPC1} + I_{VPC2} + I_{VPC3}$ )
Off $V_{CC}$ Leakage Current		5	100	uA	$V_{PC} = 0V$
Thermal Resistance		28		°C/W	junction - lead

Test Conditions:  $Z_0 = 50\Omega$ ,  $V_{CC} = V_{PC} = 3.3V$ ,  $I_{CQ} = 165\text{ mA}$ ,  $T_{BP} = 30^\circ\text{C}$

## Absolute Maximum Ratings

Parameter	Rating	Unit
VC3 Collector Bias Current (pin 14)	400	mA
VC2 Collector Bias Current (pin 15)	140	mA
VC1 Collector Bias Current (pin 16)	50	mA
Device Voltage ( $V_D$ )	4.5	V
Power Dissipation	1.4	W
Operating Lead Temperature ( $T_L$ )	-40 to +85	°C
RF Input Power for 50Ω load	20	dBm
Storage Temperature Range	-40 to +150	°C
Operating Junction Temperature ( $T_J$ )	150	°C
ESD Rating - Human Body Model, Class 1C (HBM)	1000	V



**Caution!** ESD sensitive device.

Exceeding any one or a combination of the Absolute Maximum Rating conditions may cause permanent damage to the device. Extended application of Absolute Maximum Rating conditions to the device may reduce device reliability. Specified typical performance or functional operation of the device under Absolute Maximum Rating conditions is not implied.

RoHS status based on EUDirective2002/95/EC (at time of this document revision).

The information in this publication is believed to be accurate and reliable. However, no responsibility is assumed by RF Micro Devices, Inc. ("RFMD") for its use, nor for any infringement of patents, or other rights of third parties, resulting from its use. No license is granted by implication or otherwise under any patent or patent rights of RFMD. RFMD reserves the right to change component circuitry, recommended application circuitry and specifications at any time without prior notice.

Operation of this device beyond any one of these limits may cause permanent damage. For reliable continuous operation, the device voltage and current must not exceed the maximum operating values specified in the table on page one.

Bias Conditions should also satisfy the following expression:

$$I_D V_D < (T_J - T_L) / R_{TH,j-l}$$

## Simplified Device Schematic

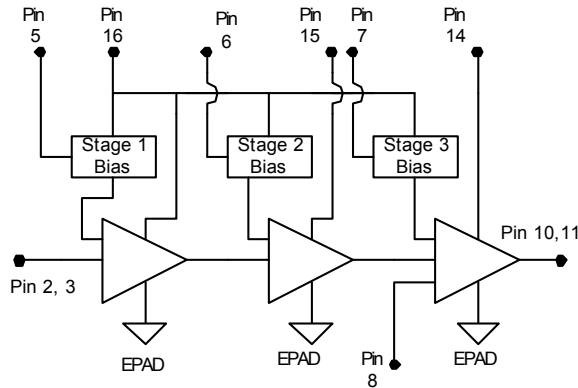

**4.9 - 5.9 GHz Evaluation Board Data (Vcc = Vpc = 3.3V, Iq = 165mA)**

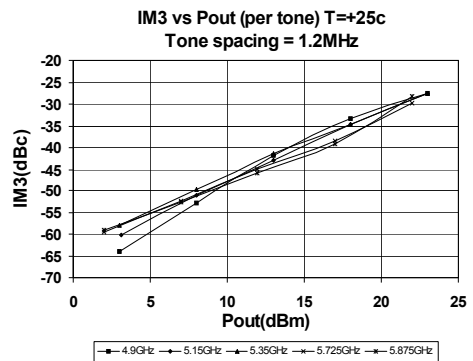
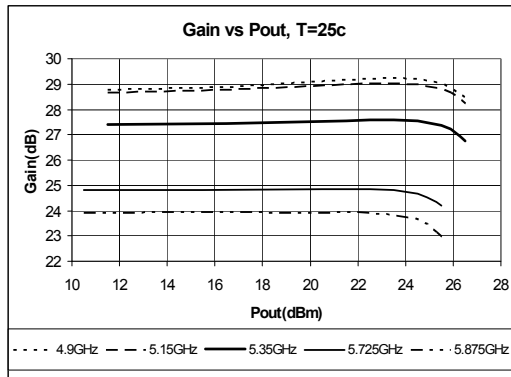
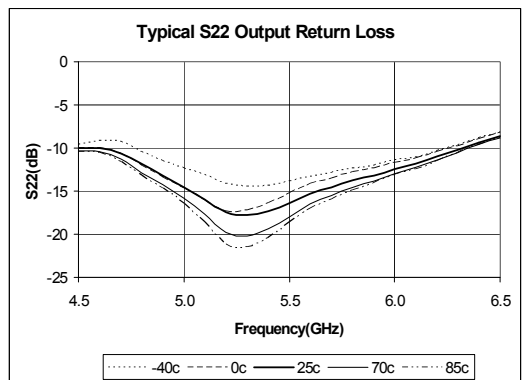
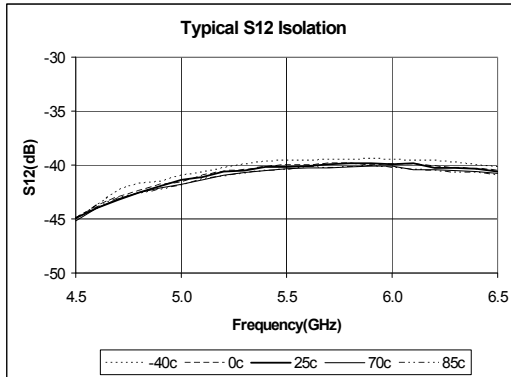
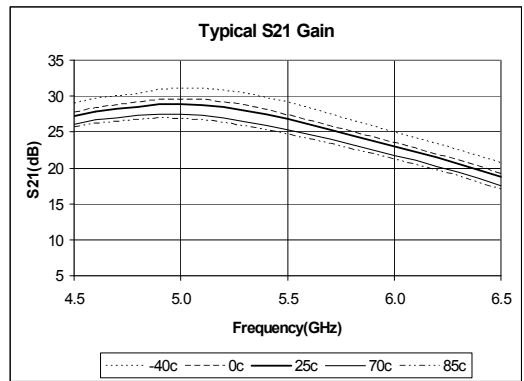
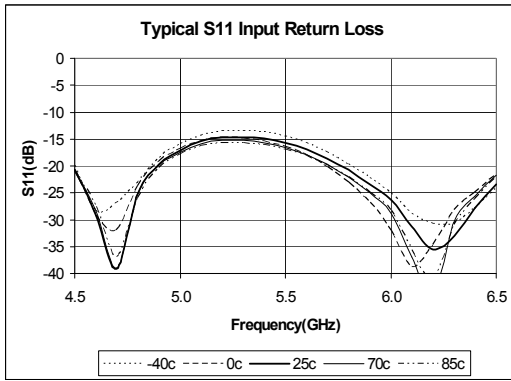

## 4.9 - 5.9 GHz Evaluation Board Data (Vcc = 3.3V, Iq = 165mA)

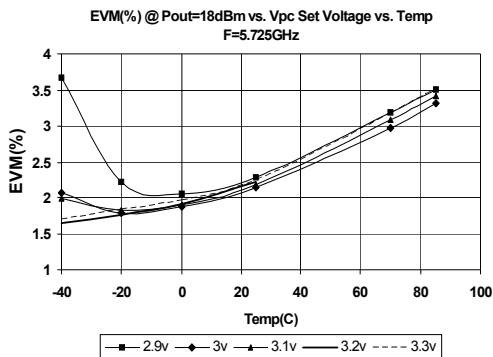
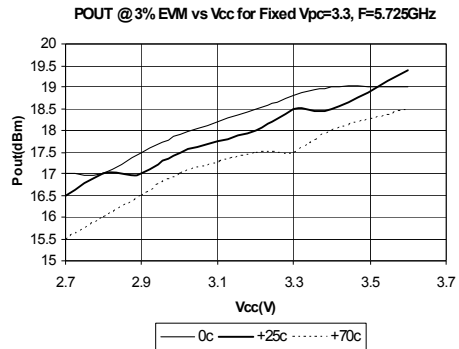
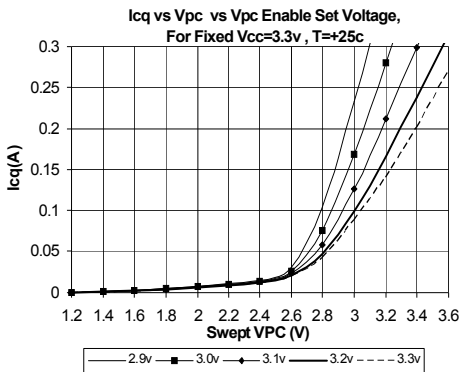
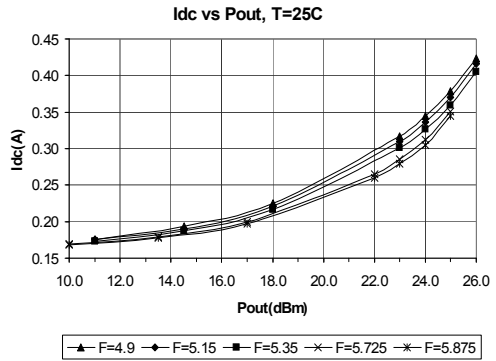
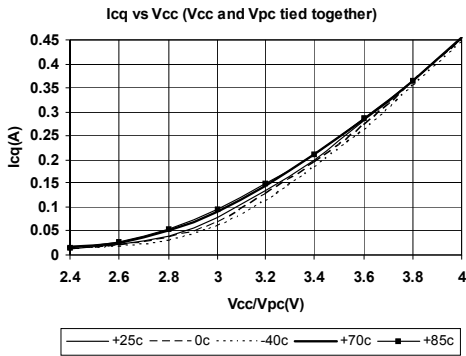

Intentionally left blank

**4.9 - 5.9 GHz Evaluation Board Data (Vcc = Vpc = 3.3V, Iq = 165mA)**

802.11a EVM, OFDM, 54Mb/s, 64QAM

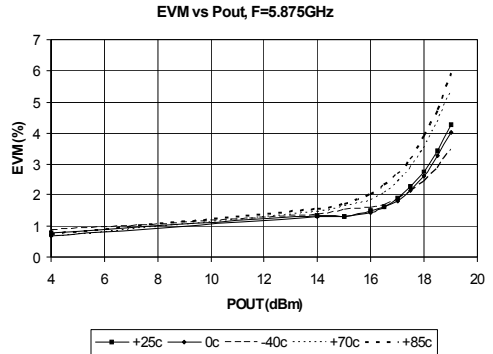
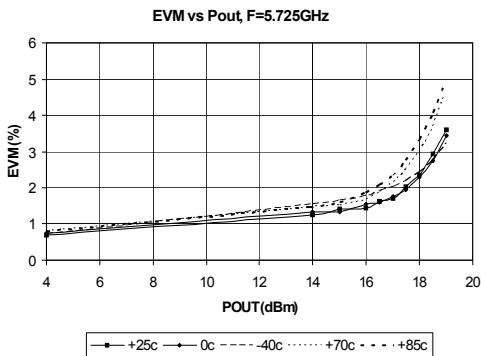
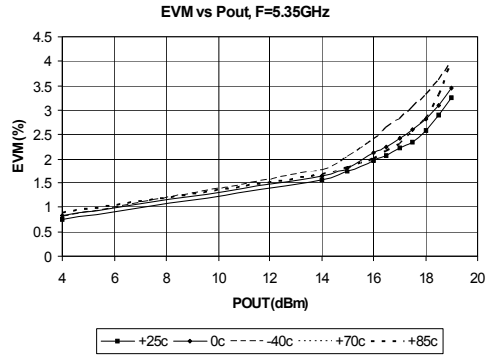
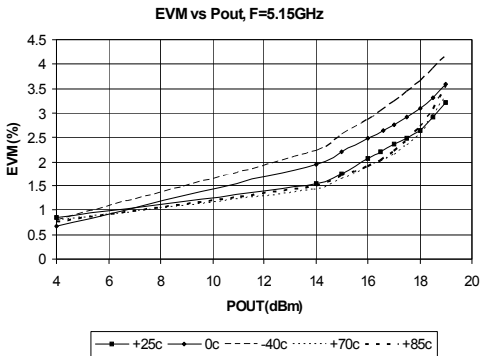
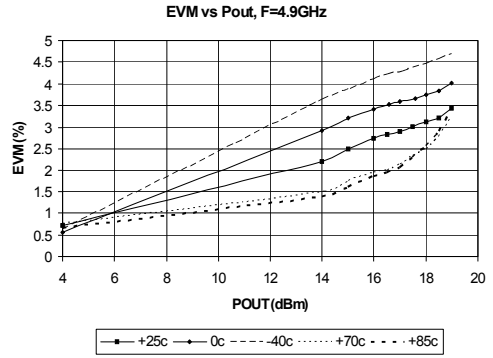
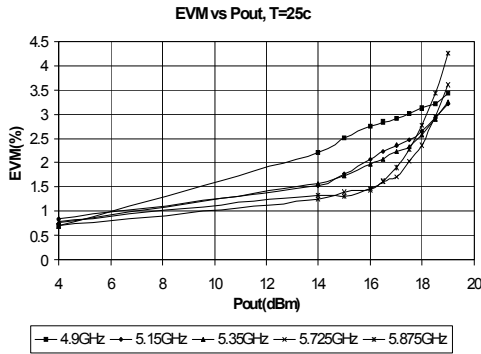

## 4.9 - 5.9 GHz Evaluation Board Data (Vcc = Vpc = 3.3V, Iq = 165mA)

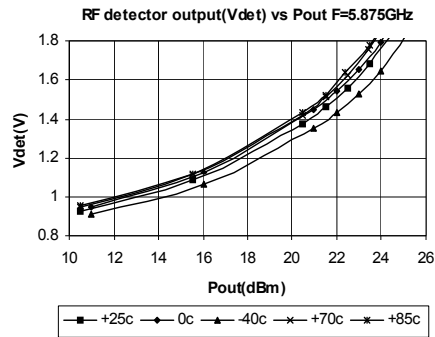
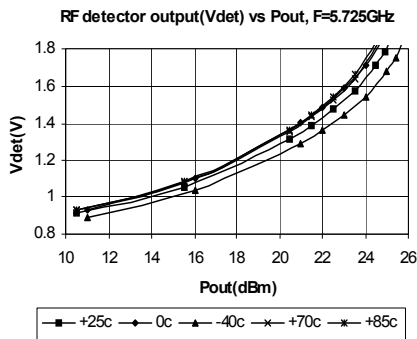
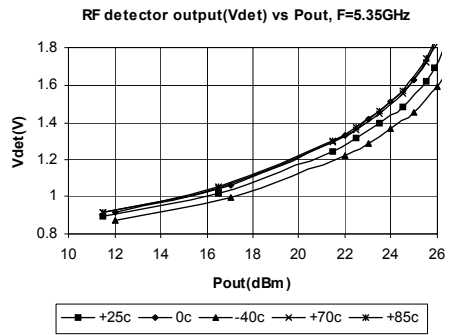
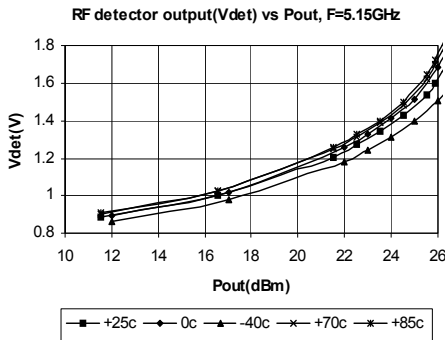
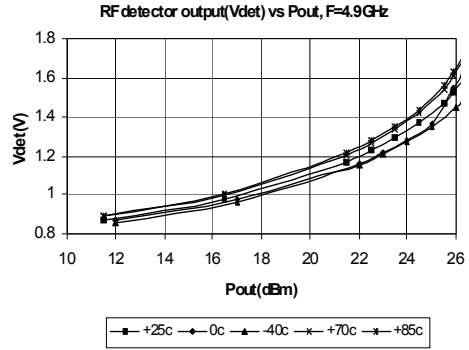
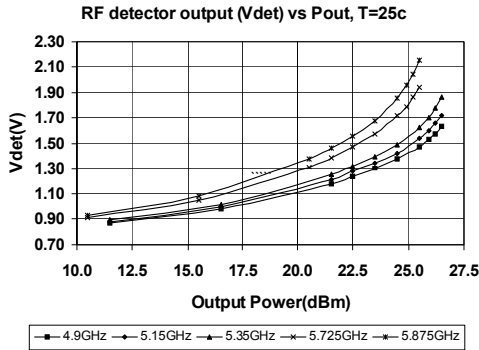

Pin	Function	Description
<b>1, 4, 9, 12, 13</b>	<b>N/C</b>	Pins are not used. May be grounded, left open, or connected to adjacent pin.
<b>5</b>	<b>VPC1</b>	VPC1 is the bias control pin for the stage 1 active bias circuit. An external series resistor is required for proper setting of bias levels. Refer to the evaluation board schematic for resistor value. To prevent potential damage, do not apply voltage to this pin that is +1V greater than voltage applied to pin 16 (Vbias) unless Vpc supply current capability is less than 10mA.
<b>6</b>	<b>VPC2</b>	VPC2 is the bias control pin for the stage 2 active bias circuit. An external series resistor is required for proper setting of bias levels. Refer to the evaluation board schematic for resistor value. To prevent potential damage, do not apply voltage to this pin that is +1V greater than voltage applied to pin 16 (Vbias) unless Vpc supply current capability is less than 10mA.
<b>7</b>	<b>VPC3</b>	VPC3 is the control pin for the stage 3 active bias circuits. An external series resistor is required for proper setting of bias levels. Refer to the evaluation board schematic for resistor value. To prevent potential damage, do not apply voltage to this pin that is +1V greater than voltage applied to pin 16 (Vbias) unless Vpc supply current capability is less than 10mA.
<b>8</b>	<b>Vdet</b>	Output power detector voltage. Load with 10K to 100K $\Omega$ to ground for best performance.
<b>2, 3</b>	<b>RFIN</b>	RF input pins. This is DC grounded internal to the IC. Do not apply voltage to this pin. All three pins must be used for proper operation.
<b>10, 11</b>	<b>RFOUT</b>	RF output pin. This is also another connection to the 3rd stage collector
<b>14</b>	<b>VC3</b>	3rd stage collector bias pin. Apply 3.0V to 3.6V to this pin.
<b>15</b>	<b>VC2</b>	2nd stage collector bias pin. Apply 3.0V to 3.6V to this pin.
<b>16</b>	<b>VC1,Vbias</b>	1st stage collector bias pin and active bias network VCC. Apply 3.0V to 3.6V to this pin.
<b>EPAD</b>	<b>Gnd</b>	Exposed area on the bottom side of the package needs to be soldered to the ground plane of the board for optimum thermal and RF performance. Several vias should be located under the EPAD as shown in the recommended land pattern).

**Land Pattern and PCB Soldermask**

**Recommended Land Pattern (dimensions in mm[in]):**

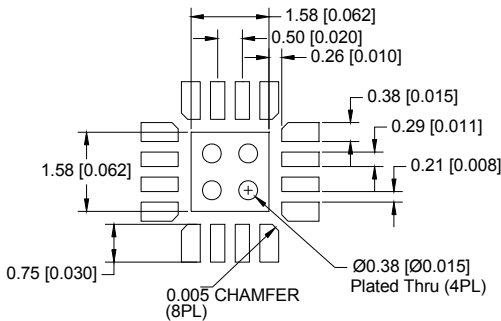

**Recommended PCB Soldermask (SMOBC) for Land Pattern(dimensions in mm[in]):**

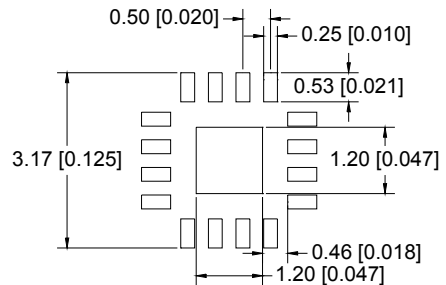

## Package Drawing

Dimensions in millimeters (inches)

Refer to drawing posted at [www.rfmd.com](http://www.rfmd.com) for tolerances.

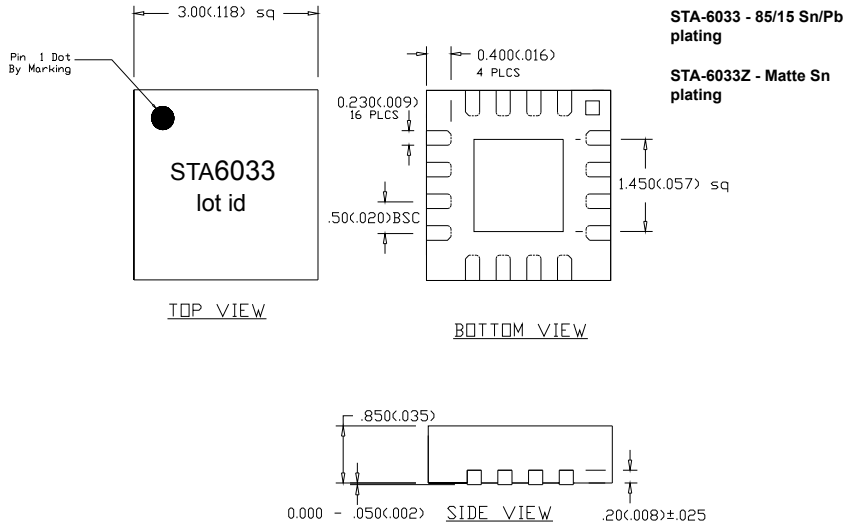

## Evaluation Board Schematic

### 4.9 - 5.9 GHz Evaluation Board Schematic For $V_{CC} = V_{PC} = V_{+} = 3.3V$ Supply

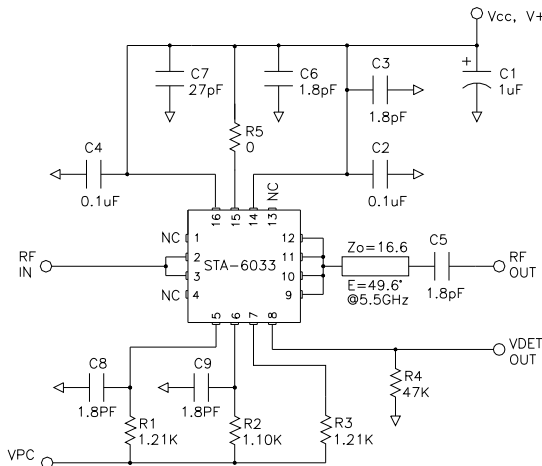

#### Notes:

R5 (0 ohm jumper) is required for parasitic inductance (~0.4nH).

R4 simulates external circuit loading to ground. Recommended load range is 47K-100K ohms.

Pins 1,4,9,12,13 are unwired (N/C) inside the package. Refer to page 2 for detailed pin descriptions. Some of these pins are wired to adjacent pins or grounded as shown in the application circuit. This is to maintain consistency with the evaluation board layout shown below. It is recommended to use this layout and wiring to achieve the specified performance.

To prevent potential damage, do not apply voltage to the Vpc pin that is +1V greater than voltage applied to pin 16 (Vbias/Vcc) unless Vpc supply current capability is less than 10 mA.

See table below for other Vpc logic level resistor values.

**Evaluation Board Layout**

**4.9 - 5.9 GHz Evaluation Board Layout For Vcc = Vpc = V+ = 3.3V Supply**

- Board material GETEK, 10mil thick, Dk=3.9, 2 oz. copper finish

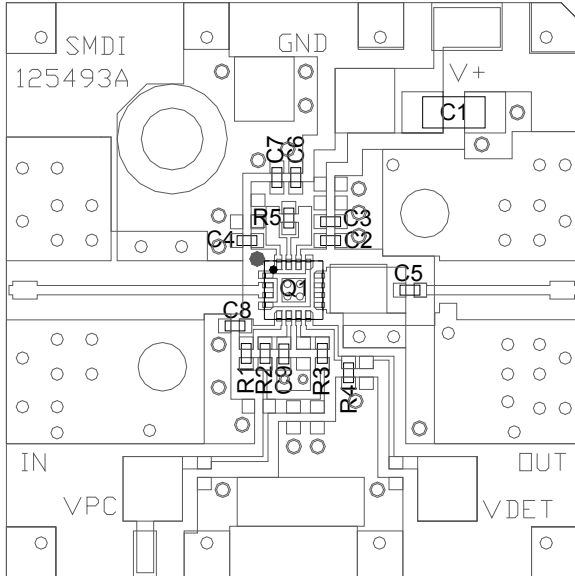

DESG	DESCRIPTION
Q1	STA-6033
R1	1.21K OHM, 1% 0402
R2	1.10K OHM, 1%, 0402
R3	1.21K OHM, 1% 0402
R4	47K OHM, 0402
R5	0 OHM, 0402
C1	1uF CERAMIC, 1206
C2,4	0.1uF CAP, 0402
C3,5,6,8,9	1.8pF CAP, 0402
C7	27pF CAP, 0402

Resistor Table for Vcc=3.3V  
(1% values are recommended)

VPC(V)	R1(ohm)	R2(ohm)	R3(ohm)
2.9	374	237	100
3.0	562	464	374
3.1	750	665	619
3.2	1K	887	909
3.3	1.21K	1.10K	1.21K



**Ordering Information**

Part Number	Reel Size	Devices/Reel
STA6033	13"	3000
STA6033Z	13"	3000
STA6033ZPCK-EVB1	Fully assembled evaluation board tuned for 4.9 to 5.9GHz and 5 piece loose samples	









## Looking for pricing, stock, or lifecycle information?

Click below to explore more details on WIN SOURCE:

-  [View STA-6033Z on WIN SOURCE](#)
-  [RF Micro Devices Information](#)

## Optimize Your Supply Chain with WIN SOURCE Solutions

-  Global Sourcing Solution
-  Obsolete Management
-  Cost Control Management
-  Shortage Management
-  Alternative Solution
-  Excess Inventory Management