



**THE DATASHEET OF
ST16C450CP40-F**



September 2003

GENERAL DESCRIPTION

The ST16C450 is a universal asynchronous receiver and transmitter. The ST16C450 is an improved version of the NS16450 UART with higher operating speed and lower access time. A programmable baud rate generator is provided to select transmit and receive clock rates from 50 Bps to 1.5 Mbps.

The ST16C450 on board status registers provides the error conditions, type and status of the transfer operation being performed. Included is complete MODEM control capability, and a processor interrupt system that may be software tailored to the user's requirements. The ST16C450 provides internal loop-back capability for on board diagnostic testing.

The ST16C450 is available in 40 pin PDIP, 44 pin PLCC, and 48 pin TQFP packages. It is fabricated in an advanced CMOS process to achieve low drain power and high speed requirements.

PLCC Package

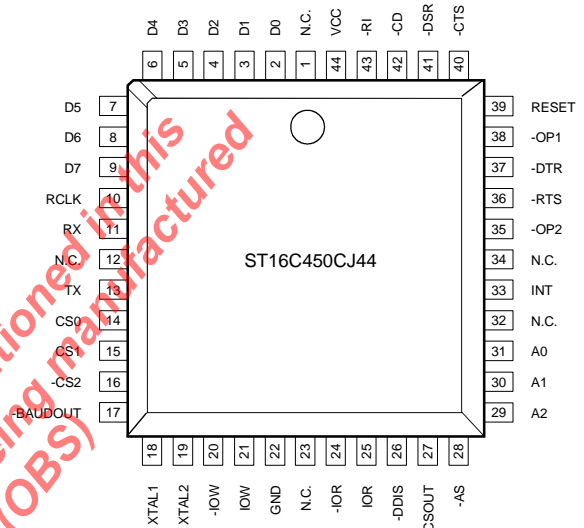

FEATURES

- Pin to pin and functionally compatible to the Industry Standard 16450
- 2.97 to 5.5 volt operation
- 1.5 Mbps transmit/receive operation (24MHz)
- Programmable word lengths (5, 6, 7, 8)
- Even, odd, force, or no parity generation and detection
- Independent transmit and receive control
- Standard modem interface
- Low operating current (1.2mA typ.)

ORDERING INFORMATION

Part number	Package	Operating temperature	Device Status
ST16C450CP40	40-Lead PDIP	0° C to + 70° C	Active. See the ST16C450CQ48 for new designs.
ST16C450CJ44	44-Lead PLCC	0° C to + 70° C	Active
ST16C450CQ48	48-Lead TQFP	0° C to + 70° C	Active
ST16C450IP40	40-Lead PDIP	-40° C to + 85° C	Active. See the ST16C450IQ48 for new designs.
ST16C450IJ44	44-Lead PLCC	-40° C to + 85° C	Active
ST16C450IQ48	48-Lead TQFP	-40° C to + 85° C	Active

Rev. 4.20

Figure 1, PACKAGE DESCRIPTION, ST16C450

48 Pin TQFP Package

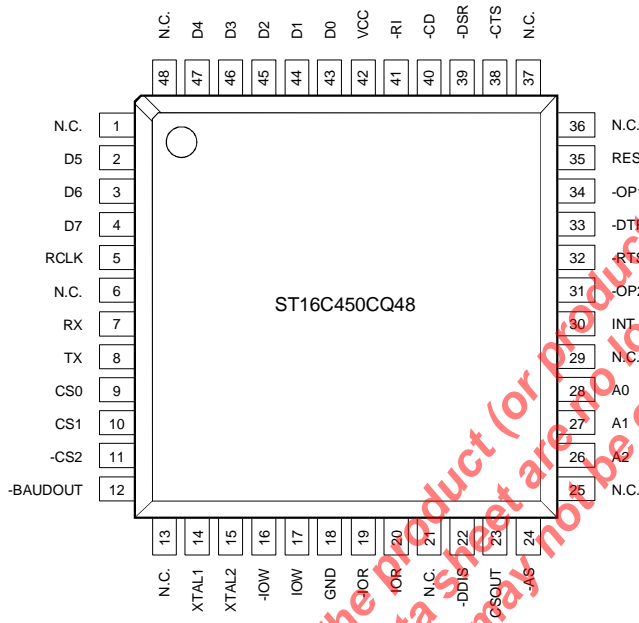

40 Pin DIP Package

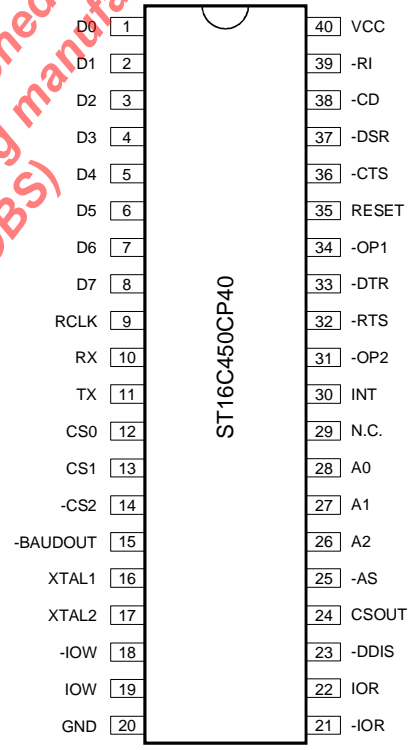

The Product (or Products) mentioned in this data sheet are no longer being manufactured and may no longer be ordered (OBS)

Figure 2, BLOCK DIAGRAM

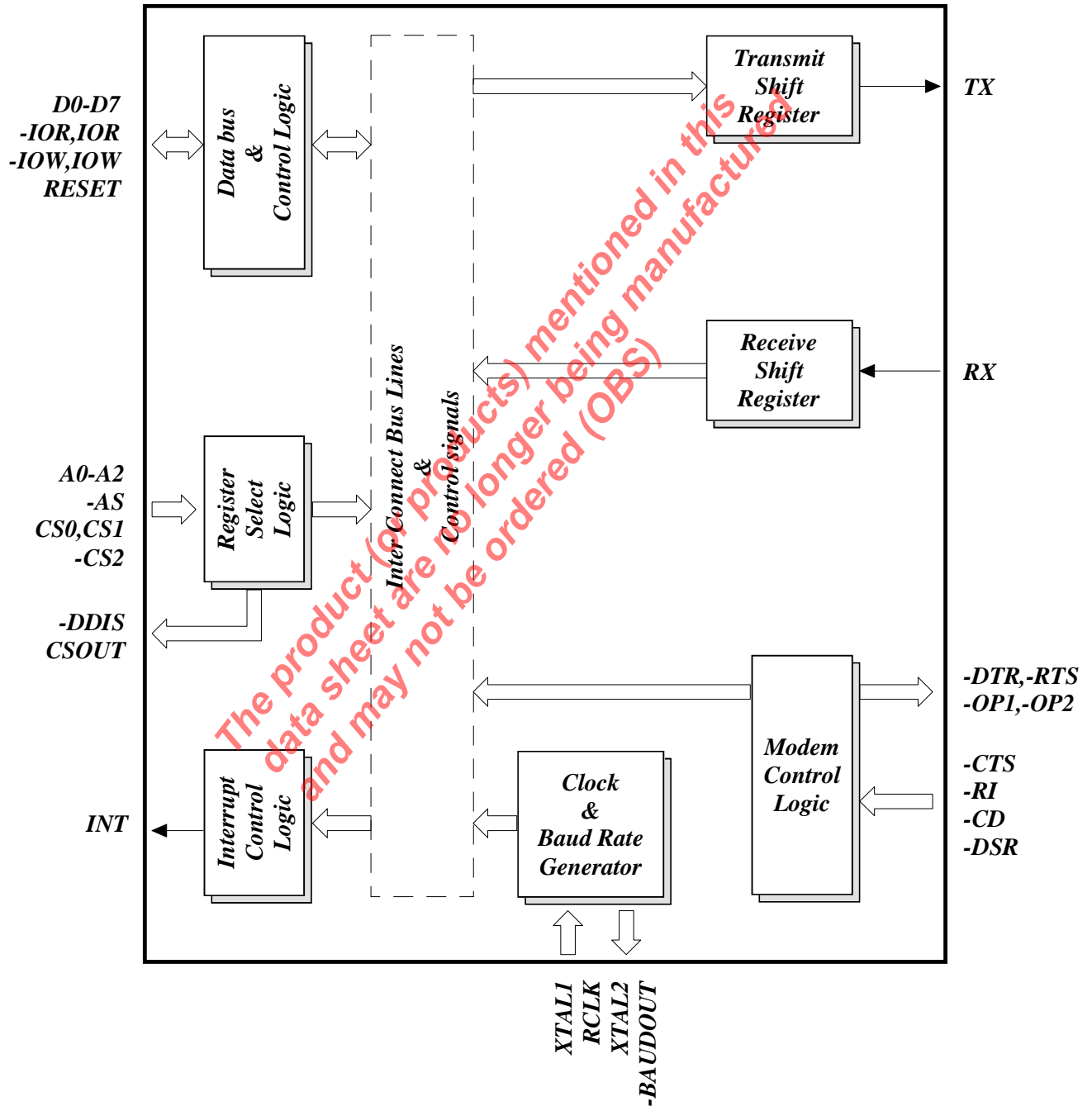

SYMBOL DESCRIPTION

Symbol	Pin			Signal type	Pin Description
	40	44	48		
A0	28	31	28	I	Address-0 Select Bit Internal registers address selection.
A1	27	30	27	I	Address-1 Select Bit Internal registers address selection.
A2	26	29	26	I	Address-2 Select Bit Internal registers address selection.
IOR	22	25	20	I	Read data strobe. Its function is the same as -IOR (see -IOR), except it is active high. Either an active -IOR or IOR is required to transfer data from 16C450 to CPU during a read operation.
CS0	12	14	9	I	Chip Select-0. Logical 1 on this pin provides the chip select-0 function.
CS1	13	15	10	I	Chip Select-1. Logical 1 on this pin provides the chip select-1 function.
-CS2	14	16	11	I	Chip Select -2. Logical 0 on this pin provides the chip select-2 function.
IOW	19	21	17	I	Write data strobe. Its function is the same as -IOW (see -IOW), but it acts as an active high input signal. Either -IOW or IOW is required to transfer data from the CPU to ST16C450 during a write operation.
-AS	25	28	24	I	Address Strobe. A logic 0 transition on -AS latches the state of the chip selects and the register select bits, A0-A2. This input is used when address and chip selects are not stable for the duration of a read or write operation, i.e., a microprocessor that needs to de-multiplex the address and data bits. If not required, the -AS input can be permanently tied to a logic 0 (it is edge triggered).
D0-D7	1-8	2-9	43-47 2-4	I/O	Data Bus (Bi-directional) - These pins are the eight bit, tri-state data bus for transferring information to or from the controlling CPU. D0 is the least significant bit and the first data bit in a transmit or receive serial data stream.
GND	20	22	18	Pwr	Signal and Power Ground.

SYMBOL DESCRIPTION

Symbol	Pin			Signal type	Pin Description
	40	44	48		
-IOR	21	24	19	I	Read data strobe (active low strobe). A logic 0 on this pin transfers the contents of the ST16C450 data bus to the CPU.
-IOW	18	20	16	I	Write data strobe (active low strobe). A logic 0 on this pin transfers the contents of the CPU data bus to the addressed internal register.
INT	30	33	30	O	Interrupt Request (active high). Interrupts are enabled in the interrupt enable register (IER), and when an interrupt condition exists. Interrupt conditions include: receiver errors, available receiver buffer data, transmit buffer empty, or when a modem status flag is detected.
CSOUT	24	27	23	O	Chip select out. A high on this pin indicates that the ST16C450 has been enabled by the chip select pin.
-BAUDOUT	15	17	12	O	Baud Rate Generator Output. This pin provides the 16X clock of the selected data rate from the baud rate generator. The RCLK pin must be connected externally to -BAUDOUT when the receiver is operating at the same data rate.
-DDIS	23	26	22	O	Drive Disable. This pin goes to a logic 0 when the external CPU is reading data from the ST16C450. This signal can be used to disable external transceivers or other logic functions.
-OP1	34	38	34	O	Output-1 (User Defined) - See bit-2 of modem control register (MCR bit-2).
RESET	35	39	35	I	Reset. (active high) - A logic 1 on this pin will reset the internal registers and all the outputs. The UART transmitter output and the receiver input will be disabled during reset time. (See ST16C450 External Reset Conditions for initialization details.)
RCLK	9	10	5	I	Receive Clock Input. This pin is used as external 16X clock input to the receiver section. External connection to -Baudout pin is required in order to utilize the internal baud rate generator.

SYMBOL DESCRIPTION

Symbol	Pin			Signal type	Pin Description
	40	44	48		
-OP2	31	35	31	O	Output-2 (User Defined). This pin provides the user a general purpose output. See bit-3 modem control register (MCR bit-3).
VCC	40	44	42	Pwr	Power Supply Input.
XTAL1	16	18	14	I	Crystal or External Clock Input - Functions as a crystal input or as an external clock input. A crystal can be connected between this pin and XTAL2 to form an internal oscillator circuit. An external 1 MW resistor is required between the XTAL1 and XTAL2 pins (see figure 3). Alternatively, an external clock can be connected to this pin to provide custom data rates (Programming Baud Rate Generator section).
XTAL2	17	19	15	O	Output of the Crystal Oscillator or Buffered Clock - (See also XTAL1). Crystal oscillator output or buffered clock output.
-CD	38	42	40	I	Carrier Detect (active low) - A logic 0 on this pin indicates that a carrier has been detected by the modem.
-CTS	36	40	38	I	Clear to Send (active low) - A logic 0 on the -CTS pin indicates the modem or data set is ready to accept transmit data from the ST16C450. Status can be tested by reading MSR bit-4. This pin has no effect on the UART's transmit or receive operation.
-DSR	37	41	39	I	Data Set Ready (active low) - A logic 0 on this pin indicates the modem or data set is powered-on and is ready for data exchange with the UART. This pin has no effect on the UART's transmit or receive operation.
-DTR	33	37	33	O	Data Terminal Ready (active low) - A logic 0 on this pin indicates that the ST16C450 is powered-on and ready. This pin can be controlled via the modem control register. Writing a logic 1 to MCR bit-0 will set the -DTR output to logic 0, enabling the modem. This pin will be a logic 1 after writing a logic 0 to MCR bit-0, or after a reset. This pin has no effect on the UART's transmit or receive operation.

SYMBOL DESCRIPTION

Symbol	Pin			Signal type	Pin Description
	40	44	48		
-RI	39	43	41	I	Ring Indicator (active low) - A logic 0 on this pin indicates the modem has received a ringing signal from the telephone line. A logic 1 transition on this input pin will generate an interrupt.
-RTS	32	36	32	O	Request to Send (active low) - A logic 0 on the -RTS pin indicates the transmitter has data ready and waiting to send. Writing a logic 1 in the modem control register (MCR bit-1) will set this pin to a logic 0 indicating data is available. After a reset this pin will be set to a logic 1. This pin has no effect on the UART's transmit or receive operation.
RX	10	11	7	I	Receive Data - This pin provides the serial receive data input to the ST16C450. The RX signal will be a logic 1 during reset, idle (no data). During the local loop-back mode, the RX input pin is disabled and TX data is internally connected to the UART RX input, internally, see figure 12.
TX	11	13	8	O	Transmit Data - This pin provides the serial transmit data from the ST16C450, the TX signal will be a logic 1 during reset, idle (no data). During the local loop-back mode, the TX input pin is disabled and TX data is internally connected to the UART RX Input, see figure 12.

GENERAL DESCRIPTION

The ST16C450 provides serial asynchronous receive data synchronization, parallel-to-serial and serial-to-parallel data conversions for both the transmitter and receiver sections. These functions are necessary for converting the serial data stream into parallel data that is required with digital data systems. Synchronization for the serial data stream is accomplished by adding start and stops bits to the transmit data to form a data character (character orientated protocol). Data integrity is insured by attaching a parity bit to the data character. The parity bit is checked by the receiver for any transmission bit errors. The electronic circuitry to

provide all these functions is fairly complex especially when manufactured on a single integrated silicon chip. The ST16C450 represents such an integration with greatly enhanced features. The ST16C450 is fabricated with an advanced CMOS process. The ST16C450 is designed to work with high speed modems and shared network environments.

The ST16C450 is capable of operation to 1.5Mbps with a 24 MHz crystal or external clock input. With a crystal of 14.7464 MHz and through a software option, the user can select data rates up to 460.8Kbps or 921.6Kbps.

FUNCTIONAL DESCRIPTIONS

Internal Registers

The ST16C450 provides 11 internal registers for monitoring and control. These registers are shown in Table 2 below. These registers function as data holding registers (THR/RHR), interrupt status and control registers (IER/ISR), line status and control registers, (LCR/LSR), modem status and control registers (MCR/MSR), programmable data rate (clock) control registers (DLL/DLM), and a user assessable scratchpad register (SPR).

Table 2, INTERNAL REGISTER DECODE

A2	A1	A0	READ MODE	WRITE MODE
General Register Set (THR/RHR, IER/ISR, MCR/MSR, LCR/LSR, SPR):				
0	0	0	Receive Holding Register	Transmit Holding Register
0	0	1		Interrupt Enable Register
0	1	0	Interrupt Status Register	
0	1	1		Line Control Register
1	0	0		Modem Control Register
1	0	1	Line Status Register	
1	1	0	Modem Status Register	
1	1	1	Scratchpad Register	Scratchpad Register
Baud Rate Register Set (DLL/DLM): Note *3				
0	0	0	LSB of Divisor Latch	LSB of Divisor Latch
0	0	1	MSB of Divisor Latch	MSB of Divisor Latch

Note *3: These registers are accessible only when LCR bit-7 is set to a logic 1.

Programmable Baud Rate Generator

The ST16C450 supports high speed modem technologies that have increased input data rates by employing data compression schemes. For example a 33.6Kbps modem that employs data compression may require a 115.2Kbps input data rate. A 128.0Kbps ISDN modem that supports data compression may need an input data rate of 460.8Kbps. The ST16C450 can support a standard data rate of 921.6Kbps.

The programmable Baud Rate Generator is capable of accepting an input clock up to 24 MHz, as required for supporting a 1.5Mbps data rate. The ST16C450 can be configured for internal or external clock operation. For internal clock oscillator operation, an industry standard microprocessor crystal (parallel resonant/ 22-33 pF load) is connected externally between the XTAL1 and XTAL2 pins, with an external 1 MΩ resistor across it.

Alternatively, an external clock can be connected to the XTAL1 pin to clock the internal baud rate generator for standard or custom rates. See figure 3 for crystal oscillator connection.

The generator divides the input 16X clock by any divisor from 1 to $2^{16} - 1$. The ST16C450 divides the basic crystal or external clock by 16. The frequency of the -BAUDOUT output pin is exactly 16X (16 times) of the selected baud rate (-BAUDOUT = 16 x Baud Rate). Customized Baud Rates can be achieved by selecting the proper divisor values for the MSB and LSB sections of baud rate generator.

Programming the Baud Rate Generator Registers DLM (MSB) and DLL (LSB) provides a user capability for selecting the desired final baud rate. The example in Table 3 below.

Table 3, BAUD RATE GENERATOR PROGRAMMING TABLE (1.8432 MHz CLOCK):

Output Baud Rate	User 16 x Clock Divisor (Decimal)	User 16 x Clock Divisor (HEX)	DLM Program Value (HEX)	DLL Program Value (HEX)
50	2304	900	09	00
75	1536	600	06	00
150	768	300	03	00
300	384	180	01	80
600	192	C0	00	C0
1200	96	60	00	60
2400	48	30	00	30
4800	24	18	00	18
7200	16	10	00	10
9600	12	0C	00	0C
19.2k	6	06	00	06
38.4k	3	03	00	03
57.6k	2	02	00	02
115.2k	1	01	00	01

Figure 3, EXTERNAL CRYSTAL OSCILLATOR CONNECTION

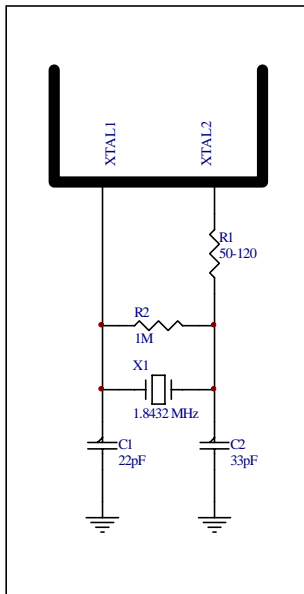

associated interface pins, and instead are connected together internally (See Figure 4). The -CTS, -DSR, -CD, and -RI are disconnected from their normal modem control inputs pins, and instead are connected internally to -DTR, -RTS, -OP1 and -OP2. Loop-back test data is entered into the transmit holding register via the user data bus interface, D0-D7. The transmit UART serializes the data and passes the serial data to the receive UART via the internal loop-back connection. The receive UART converts the serial data back into parallel data that is then made available at the user data interface, D0-D7. The user optionally compares the received data to the initial transmitted data for verifying error free operation of the UART TX/RX circuits.

In this mode, the receiver and transmitter interrupts are fully operational. The Modem Control Interrupts are also operational. However, the interrupts can only be read using lower four bits of the Modem Control Register (MCR bits 0-3) instead of the four Modem Status Register bits 4-7. The interrupts are still controlled by the IER.

The product (or products) mentioned in this data sheet are no longer being manufactured and may not be ordered.

Loopback Mode

The internal loop-back capability allows onboard diagnostics. In the loop-back mode the normal modem interface pins are disconnected and reconfigured for loop-back internally. In this mode MSR bits 4-7 are also disconnected. However, MCR register bits 0-3 can be used for controlling loop-back diagnostic testing. In the loop-back mode -OP1 and -OP2 in the MCR register (bits 0-1) control the modem -RI and -CD inputs respectively. MCR signals -DTR and -RTS (bits 0-1) are used to control the modem -CTS and -DSR inputs respectively. The transmitter output (TX) and the receiver input (RX) are disconnected from their

Figure 4, INTERNAL LOOPBACK MODE DIAGRAM

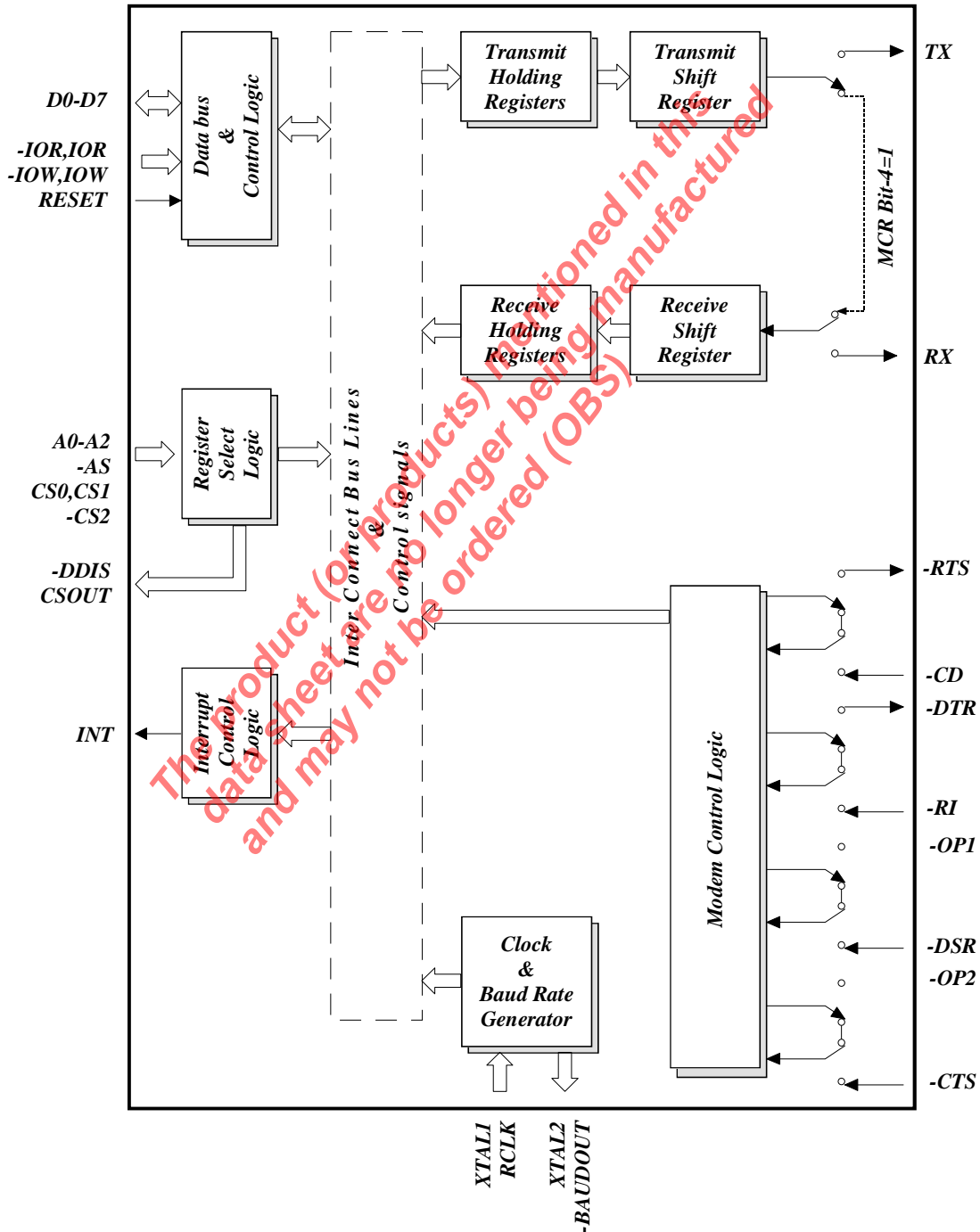

REGISTER FUNCTIONAL DESCRIPTIONS

The following table delineates the assigned bit functions for the twelve ST16C450 internal registers. The assigned bit functions are more fully defined in the following paragraphs.

Table 4, ST16C450 INTERNAL REGISTERS

A2	A1	A0	Register [Default] Note *5	BIT-7	BIT-6	BIT-5	BIT-4	BIT-3	BIT-2	BIT-1	BIT-0
General Register Set											
0	0	0	RHR [XX]	bit-7	bit-6	bit-5	bit-4	bit-3	bit-2	bit-1	bit-0
0	0	0	THR [XX]	bit-7	bit-6	bit-5	bit-4	bit-3	bit-2	bit-1	bit-0
0	0	1	IER [00]	0	0	0	0	modem status interrupt	receive line status interrupt	transmit holding register	receive holding register
0	1	0	ISR [01]	0	0	0	0	INT priority bit-2	INT priority bit-1	INT priority bit-0	INT status
0	1	1	LCR [00]	divisor latch enable	set break	set parity	even parity	parity enable	stop bits	word length bit-1	word length bit-0
1	0	0	MCR [00]	0	0	0	loop back	-OP2	-OP1	-RTS	-DTR
1	0	1	LSR [60]	0	trans. empty	trans. holding empty	break interrupt	framing error	parity error	overrun error	receive data ready
1	1	0	MSR [X0]	CD	RI	DSR	CTS	delta -CD	delta -RI	delta -DSR	delta -CTS
1	1	1	SPR [FF]	bit-7	bit-6	bit-5	bit-4	bit-3	bit-2	bit-1	bit-0
Special Register Set: Note *3											
0	0	0	DLL [XX]	bit-7	bit-6	bit-5	bit-4	bit-3	bit-2	bit-1	bit-0
0	0	1	DLM [XX]	bit-15	bit-14	bit-13	bit-12	bit-11	bit-10	bit-9	bit-8

Note *3: The Special register set is accessible only when LCR bit-7 is set to a logic 1.

Note *5: The value represents the register's initialized HEX value. An "X" signifies a 4-bit un-initialized nibble.

Transmit and Receive Holding Register

The serial transmitter section consists of an 8-bit Transmit Hold Register (THR) and Transmit Shift Register (TSR). The status of the THR is provided in the Line Status Register (LSR). Writing to the THR transfers the contents of the data bus (D7-D0) to the THR, providing that the THR or TSR is empty. The THR empty flag in the LSR register will be set to a logic 1 when the transmitter is empty or when data is transferred to the TSR. Note that a write operation can be performed when the transmit holding register empty flag is set.

The serial receive section also contains an 8-bit Receive Holding Register, RHR. Receive data is removed from the ST16C450 and receive by reading the RHR register. The receive section provides a mechanism to prevent false starts. On the falling edge of a start or false start bit, an internal receiver counter starts counting clocks at 16x clock rate. After 7 1/2 clocks the start bit time should be shifted to the center of the start bit. At this time the start bit is sampled and if it is still a logic 0 it is validated. Evaluating the start bit in this manner prevents the receiver from assembling a false character. Receiver status codes will be posted in the LSR.

Interrupt Enable Register (IER)

The Interrupt Enable Register (IER) masks the interrupts from receiver ready, transmitter empty, line status and modem status registers. These interrupts would normally be seen on the ST16C450 INT output pin.

IER BIT-0:

Logic 0 = Disable the receiver ready interrupt. (normal default condition)

Logic 1 = Enable the receiver ready interrupt.

IER BIT-1:

Logic 0 = Disable the transmitter empty interrupt. (normal default condition)

Logic 1 = Enable the transmitter empty interrupt.

IER BIT-2:

Logic 0 = Disable the receiver line status interrupt. (normal default condition)

Logic 1 = Enable the receiver line status interrupt.

IER BIT-3:

Logic 0 = Disable the modem status register interrupt. (normal default condition)

Logic 1 = Enable the modem status register interrupt.

IER BIT 4-7: Not used and set to "0".

Interrupt Status Register (ISR)

The ST16C450 provides four levels of prioritized interrupts to minimize external software interaction. The Interrupt Status Register (ISR) provides the user with four interrupt status bits. Performing a read cycle on the ISR will provide the user with the highest pending interrupt level to be serviced. No other interrupts are acknowledged until the pending interrupt is serviced. Whenever the interrupt status register is read, the interrupt status is cleared. However it should be noted that only the current pending interrupt is cleared by the read. A lower level interrupt may be seen after rereading the interrupt status bits. The Interrupt Source Table 5 (below) shows the data values (bit 0-3) for the four prioritized interrupt levels and the interrupt sources associated with each of these interrupt levels:

Table 5, INTERRUPT SOURCE TABLE

Priority Level	[ISR]				Source of the interrupt
	Bit-3	Bit-2	Bit-1	Bit-0	
1	0	1	1	0	LSR (Receiver Line Status Register)
2	0	1	0	0	RXRDY (Received Data Ready)
3	0	0	1	0	TXRDY (Transmitter Holding Register Empty)
4	0	0	0	0	MSR (Modem Status Register)

ISR BIT-0:

Logic 0 = An interrupt is pending and the ISR contents may be used as a pointer to the appropriate interrupt service routine.

Logic 1 = No interrupt pending. (normal default condition)

ISR BIT 1-3: (logic 0 or cleared is the default condition)

These bits indicate the source for a pending interrupt at interrupt priority levels 1, 2, and 3 (See Interrupt Source Table).

ISR BIT 4-7: Not used and set to "0".

Line Control Register (LCR)

The Line Control Register is used to specify the asynchronous data communication format. The word length, the number of stop bits, and the parity are selected by writing the appropriate bits in this register.

LCR BIT 0-1: (logic 0 or cleared is the default condition)

These two bits specify the word length to be transmitted or received.

BIT-1	BIT-0	Word length
0	0	5
0	1	6
1	0	7
1	1	8

LCR BIT-2: (logic 0 or cleared is the default condition)

The length of stop bit is specified by this bit in conjunction with the programmed word length.

BIT-2	Word length	Stop bit length (Bit time(s))
0	5,6,7,8	1
1	5	1-1/2
1	6,7,8	2

LCR BIT-3:

Parity or no parity can be selected via this bit.

Logic 0 = No parity (normal default condition)

Logic 1 = A parity bit is generated during the transmission, receiver checks the data and parity for transmission errors.

LCR BIT-4:

If the parity bit is enabled with LCR bit-3 set to a logic 1, LCR BIT-4 selects the even or odd parity format.

Logic 0 = ODD Parity is generated by forcing an odd number of logic 1's in the transmitted data. The receiver must be programmed to check the same format. (normal default condition)

Logic 1 = EVEN Parity is generated by forcing an even the number of logic 1's in the transmitted. The receiver must be programmed to check the same format.

LCR BIT-5:

If the parity bit is enabled, LCR BIT-5 selects the forced parity format.

LCR BIT-5 = logic 0, parity is not forced (normal default condition)

LCR BIT-5 = logic 1 and LCR BIT-4 = logic 0, parity bit is forced to a logical 1 for the transmit and receive data.

LCR BIT-5 = logic 1 and LCR BIT-4 = logic 1, parity bit is forced to a logical 0 for the transmit and receive data.

LCR Bit-5	LCR Bit-4	LCR Bit-3	Parity selection
X	X	0	No parity
0	0	1	Odd parity
0	1	1	Even parity
1	0	1	Force parity "1"
1	1	1	Forced parity "0"

LCR BIT-6:

When enabled the Break control bit causes a break condition to be transmitted (the TX output is forced to a logic 0 state). This condition exists until disabled by setting LCR bit-6 to a logic 0.

Logic 0 = No TX break condition. (normal default condition)

Logic 1 = Forces the transmitter output (TX) to a logic 0 for alerting the remote receiver to a line break condition.

LCR BIT-7:

The internal baud rate counter latch and Enhance Feature mode enable.

Logic 0 = Divisor latch disabled. (normal default condition)

Logic 1 = Divisor latch and enhanced feature register enabled.

Modem Control Register (MCR)

This register controls the interface with the modem or a peripheral device.

MCR BIT-0:

Logic 0 = Force -DTR output to a logic 1. (normal default condition)

Logic 1 = Force -DTR output to a logic 0.

MCR BIT-1:

Logic 0 = Force -RTS output to a logic 1. (normal default condition)

Logic 1 = Force -RTS output to a logic 0.

MCR BIT-2:

Logic 0 = Set -OP1 output to a logic 1. (normal default condition)

Logic 1 = Set -OP1 output to a logic 0.

MCR BIT-3:

Logic 0 = Set -OP2 output to a logic 1. (normal default condition)

Logic 1 = Set -OP2 output to a logic 0.

MCR BIT-4:

Logic 0 = Disable loop-back mode. (normal default condition)

Logic 1 = Enable local loop-back mode (diagnostics).

MCR BIT 5-7: Not used and set to "0".

Line Status Register (LSR)

This register provides the status of data transfers between the ST16C450 and the CPU.

LSR BIT-0:

Logic 0 = No data in receive holding register. (normal default condition)

Logic 1 = Data has been received and is saved in the receive holding register.

LSR BIT-1:

Logic 0 = No overrun error. (normal default condition)

Logic 1 = Overrun error. A data overrun error occurred in the receive shift register. This happens when additional data arrives while the RHR is full. In this case the previous data in the shift register is overwritten. Note that under this condition the data byte in the receive shift register is not transfer into the RHR, therefore the data in the RHR is not corrupted by the error.

LSR BIT-2:

Logic 0 = No parity error (normal default condition)

Logic 1 = Parity error. The receive character does not have correct parity information and is suspect.

LSR BIT-3:

Logic 0 = No framing error (normal default condition).
Logic 1 = Framing error. The receive character did not have a valid stop bit(s).

LSR BIT-4:

Logic 0 = No break condition (normal default condition)
Logic 1 = The receiver received a break signal.

LSR BIT-5:

This bit indicates that the ST16C450 is ready to accept new characters for transmission. This bit causes the ST16C450 to issue an interrupt to the CPU when the transmit holding register is empty and the interrupt enable is set.

Logic 0 = Transmit holding register is not empty. (normal default condition)

Logic 1 = Transmit holding register is empty. When this bit is a logic 1, the CPU can load a new characters into the Transmit Holding Register for transmission.

LSR BIT-6:

Logic 0 = Transmitter holding and shift registers are full.

Logic 1 = Transmitter holding and shift registers are empty.

LSR BIT-7: Not used and set to "0".

Modem Status Register (MSR)

This register provides the current state of the control interface signals from the modem, or other peripheral device that the ST16C450 is connected to. Four bits of this register are used to indicate the changed information. These bits are set to a logic 1 whenever a control input from the modem changes state. These bits are set to a logic 0 whenever the CPU reads this register.

MSR BIT-0:

Logic 0 = No -CTS Change (normal default condition)
Logic 1 = The -CTS input to the ST16C450 has changed state since the last time it was read. A modem Status Interrupt will be generated.

MSR BIT-1:

Logic 0 = No -DSR Change (normal default condition)
Logic 1 = The -DSR input to the ST16C450 has changed state since the last time it was read. A modem Status Interrupt will be generated.

MSR BIT-2:

Logic 0 = No -RI Change (normal default condition)
Logic 1 = The -RI input to the ST16C450 has changed from a logic 0 to a logic 1. A modem Status Interrupt will be generated.

MSR BIT-3:

Logic 0 = No -CD Change (normal default condition)
Logic 1 = Indicates that the -CD input to the has changed state since the last time it was read. A modem Status Interrupt will be generated.

MSR BIT-4:

CTS (active high, logical 1). Normally this bit is the compliment of the -CTS input. In the loop-back mode, this bit is equivalent to the RTS bit in the MCR register.

MSR BIT-5:

DSR (active high, logical 1). Normally this bit is the compliment of the -DSR input. In the loop-back mode, this bit is equivalent to the DTR bit in the MCR register.

MSR BIT-6:

RI (active high, logical 1). Normally this bit is the compliment of the -RI input. In the loop-back mode this bit is equivalent to the OP1 bit in the MCR register.

MSR BIT-7:

CD (active high, logical 1). Normally this bit is the compliment of the -CD input. In the loop-back mode this bit is equivalent to the OP2 bit in the MCR register.

Scratchpad Register (SPR)

The ST16C450 provides a temporary data register to store 8 bits of user information.

ST16C450 EXTERNAL RESET CONDITIONS

REGISTERS	RESET STATE
IER ISR	IER BITS 0-7 = logic 0 ISR BIT-0=1, ISR BITS 1-7 = logic 0
LCR, MCR LSR	BITS 0-7 = logic 0 LSR BITS 0-4 = logic 0, LSR BITS 5-6 = logic 1 LSR, BIT 7 = logic 0
MSR	MSR BITS 0-3 = logic 0, MSR BITS 4-7 = logic levels of the input signals

SIGNALS	RESET STATE
TX	Logic 1
-OP1	Logic 1
-OP2	Logic 1
-RTS	Logic 1
-DTR	Logic 1
CSOUT	Logic 0
INT	Logic 0

The product (or products) mentioned in this data sheet are no longer being manufactured and may not be ordered (OBS)

AC ELECTRICAL CHARACTERISTICS

$T_A=0^\circ - 70^\circ\text{C}$ ($-40^\circ - +85^\circ\text{C}$ for Industrial grade packages), $V_{CC}=3.3 - 5.0\text{ V} \pm 10\%$ unless otherwise specified.

Symbol	Parameter	Limits 3.3		Limits 5.0		Units	Conditions
		Min	Max	Min	Max		
T_{1w}, T_{2w}	Clock pulse duration	17		17		ns	
T_{3w}	Oscillator/Clock frequency		8		24	MHz	
T_{4w}	Address strobe width	35		25		ns	
T_{5s}	Address setup time	5		0		ns	
T_{5h}	Address hold time	5		5		ns	
T_{6s}	Address setup time	5		0		ns	
T_{6h}	Chip select hold time	0		0		ns	
T_{7d}	-IOR delay from chip select	10		10		ns	Note 1:
T_{7w}	-IOR strobe width	35		25		ns	
T_{7h}	Chip select hold time from -IOR	0		0		ns	Note 1:
T_{8d}	-IOR delay from address	10		10		ns	Note 1:
T_{9d}	Read cycle delay	40		30		ns	
T_{10d}	CSOUT delay from chip select		15		10	ns	100 pF load
T_{11d}	-IOR to -DDIS delay		15		10	ns	100 pF load
T_{12d}	Delay from -IOR to data		35		25	ns	
T_{12h}	Data disable time		25		15	ns	
T_{13d}	-IOW delay from chip select	10		10		ns	Note 1:
T_{13w}	-IOW strobe width	40		25		ns	
T_{13h}	Chip select hold time from -IOW	0		0		ns	
T_{14d}	-IOW delay from address	10		10		ns	Note 1:
T_{15d}	Write cycle delay	40		30		ns	
T_{16s}	Data setup time	20		15		ns	
T_{16h}	Data hold time	5		5		ns	
T_{17d}	Delay from -IOW to output		50		40	ns	100 pF load
T_{18d}	Delay to set interrupt from MODEM input		40		35	ns	100 pF load
T_{19d}	Delay to reset interrupt from -IOR		40		35	ns	100 pF load
T_{20d}	Delay from stop to set interrupt		1		1	Rclk	
T_{21d}	Delay from -IOR to reset interrupt		45		40	ns	100 pF load
T_{22d}	Delay from stop to interrupt		45		40	ns	
T_{23d}	Delay from initial INT reset to transmit start	8	24	8	24	Rclk	
T_{24d}	Delay from -IOW to reset interrupt		45		40	ns	
T_R	Reset pulse width	40		40		ns	
N	Baud rate divisor	1	$2^{16}-1$	1	$2^{16}-1$	Rclk	

Note 1: Applicable only when -AS is tied low.

ABSOLUTE MAXIMUM RATINGS

Supply range	7 Volts
Voltage at any pin	GND - 0.3 V to VCC +0.3 V
Operating temperature	-40° C to +85° C
Storage temperature	-65° C to 150° C
Package dissipation	500 mW

DC ELECTRICAL CHARACTERISTICS

$T_A=0^\circ - 70^\circ\text{C}$ ($-40^\circ - +85^\circ\text{C}$ for Industrial grade packages), $V_{CC}=3.3 - 5.0\text{ V} \pm 10\%$ unless otherwise specified.

Symbol	Parameter	Limits 3.3		Limits 5.0		Units	Conditions
		Min	Max	Min	Max		
V_{ILCK}	Clock input low level	-0.3	0.6	-0.5	0.6	V	
V_{IHCK}	Clock input high level	2.4	VCC	3.0	VCC	V	
V_{IL}	Input low level	-0.3	0.8	-0.5	0.8	V	
V_{IH}	Input high level	2.0		2.2	VCC	V	
V_{OL}	Output low level on all outputs				0.4	V	$I_{OL} = 5\text{ mA}$
V_{OL}	Output low level on all outputs		0.4			V	$I_{OL} = 4\text{ mA}$
V_{OH}	Output high level			2.4		V	$I_{OH} = -5\text{ mA}$
V_{OH}	Output high level	2.0				V	$I_{OH} = -1\text{ mA}$
I_{IL}	Input leakage		± 10		± 10	μA	
I_{CL}	Clock leakage		± 10		± 10	μA	
I_{CC}	Avg power supply current		1.3		3	mA	
C_P	Input capacitance		5		5	pF	

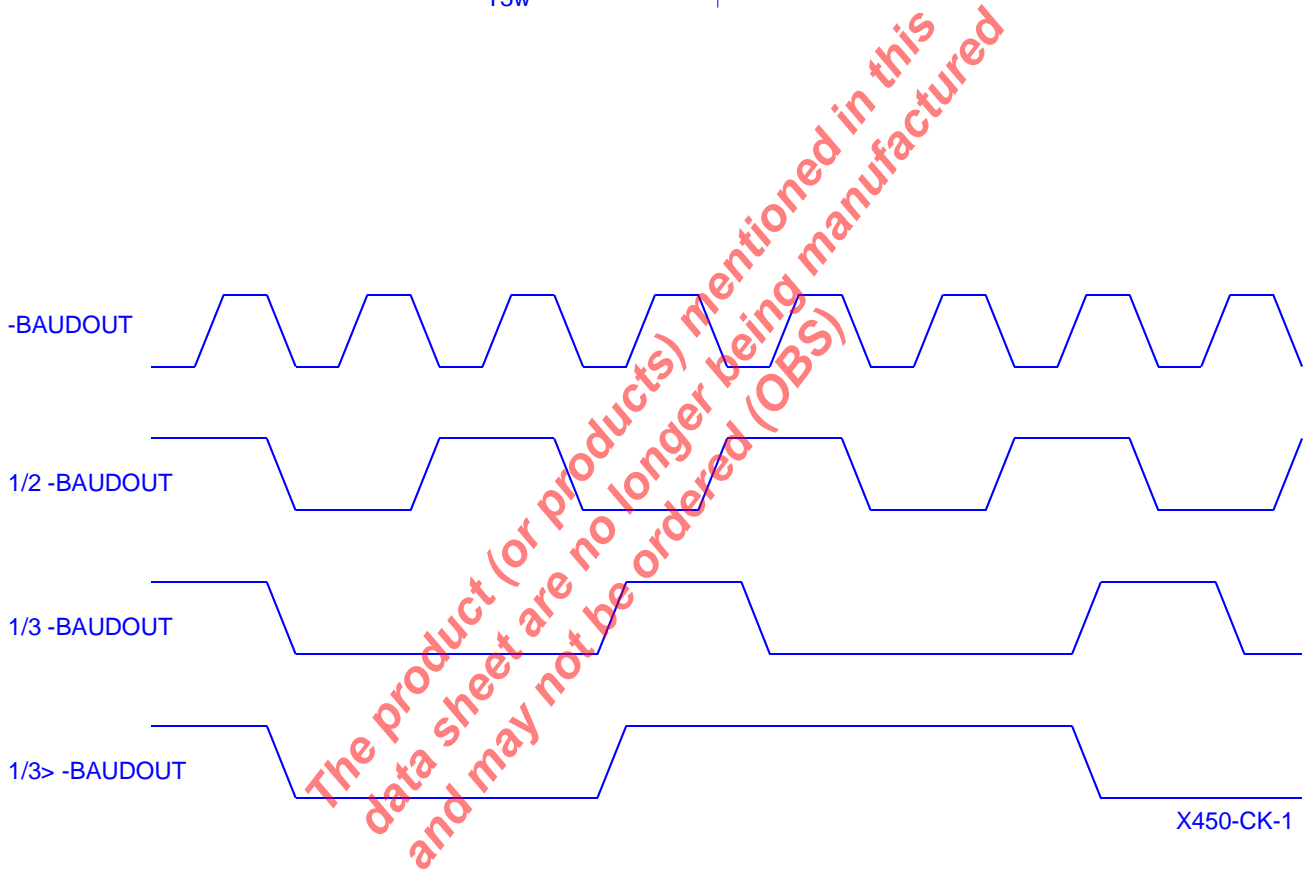
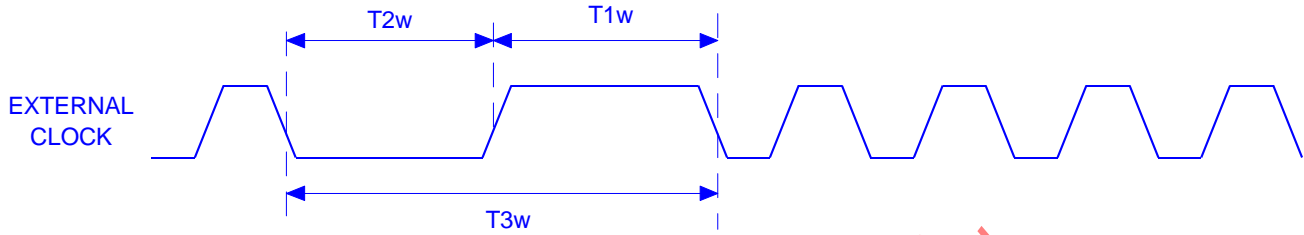

X450-CK-1

Clock timing

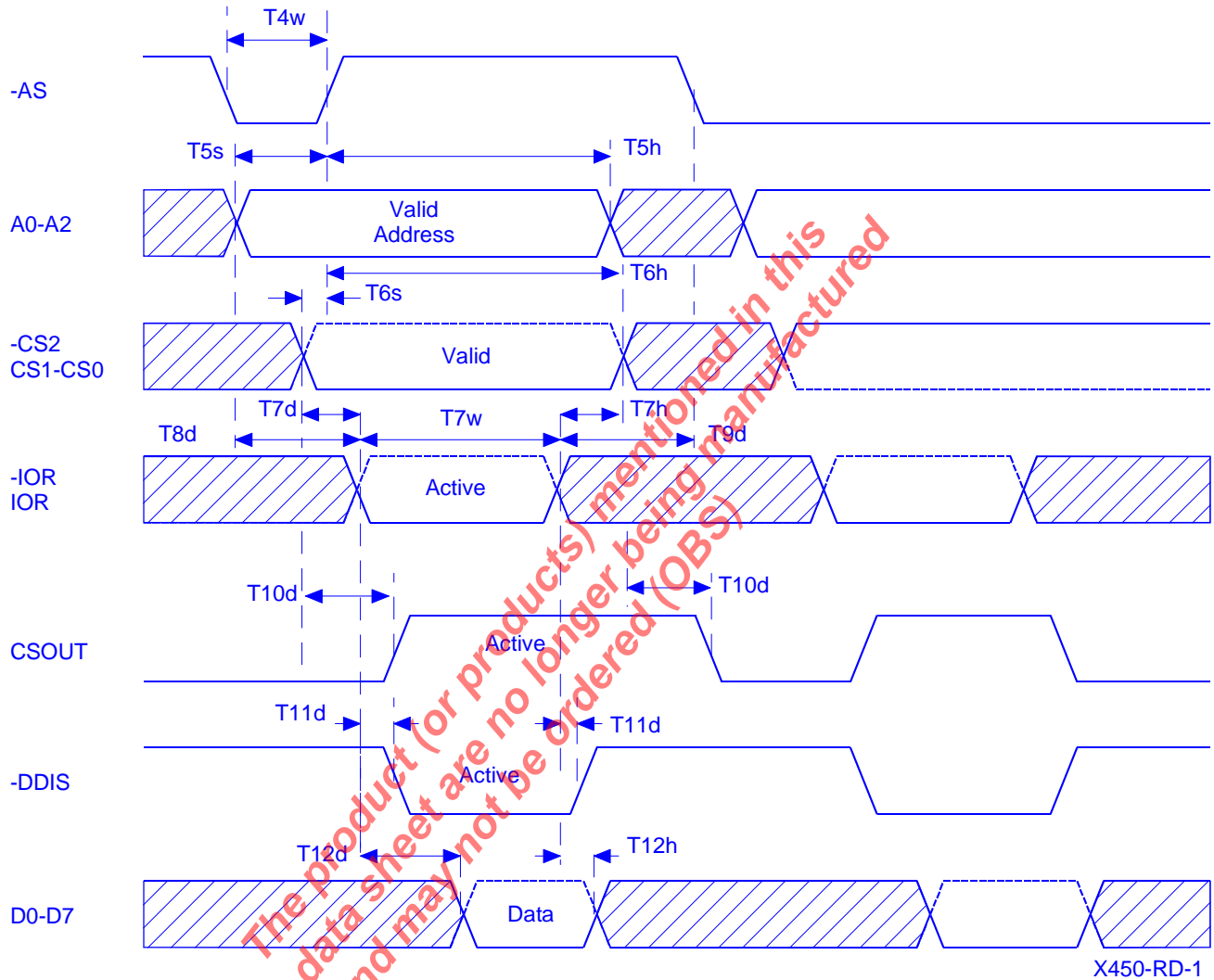

General read timing

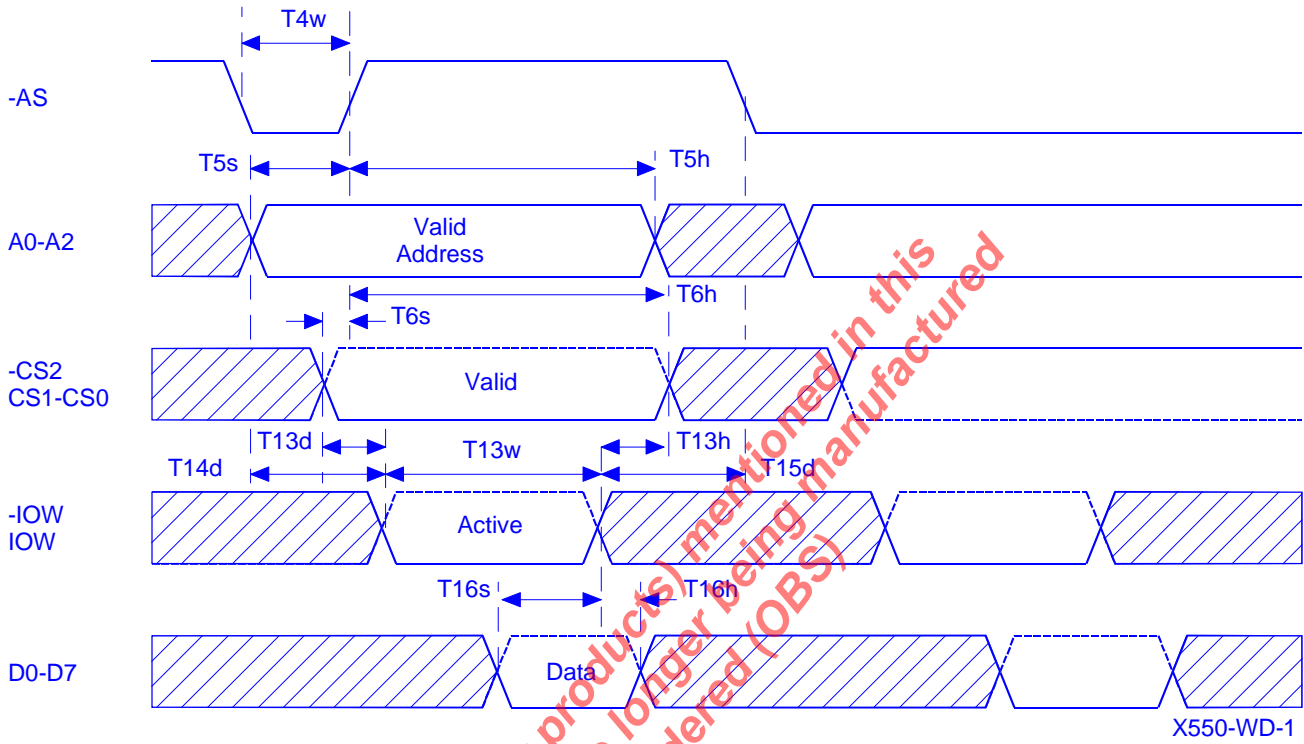

General write timing

The product (or products) mentioned in this data sheet are no longer being manufactured and may not be ordered (OBS)

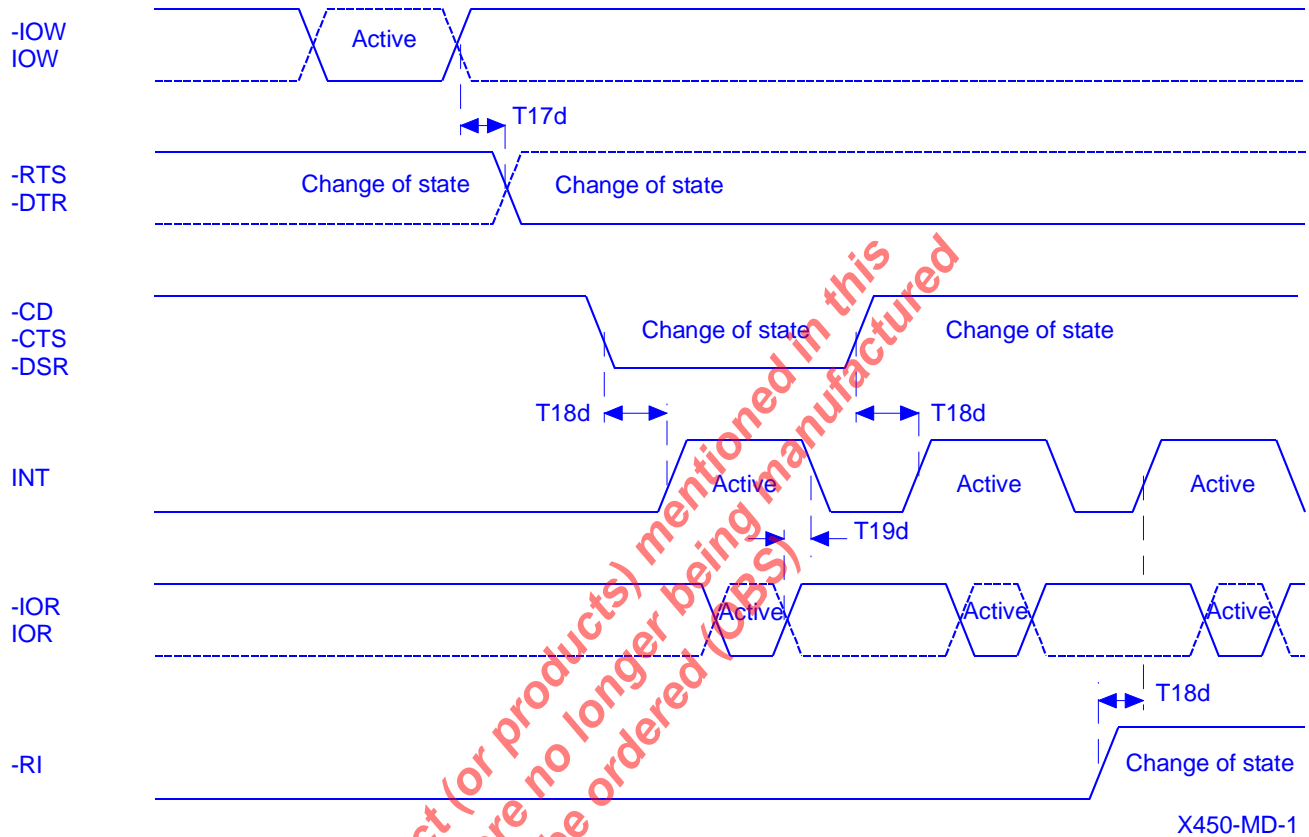

The product (or products) mentioned in this data sheet are no longer being manufactured and may not be ordered (OBS)

Modem input/output timing

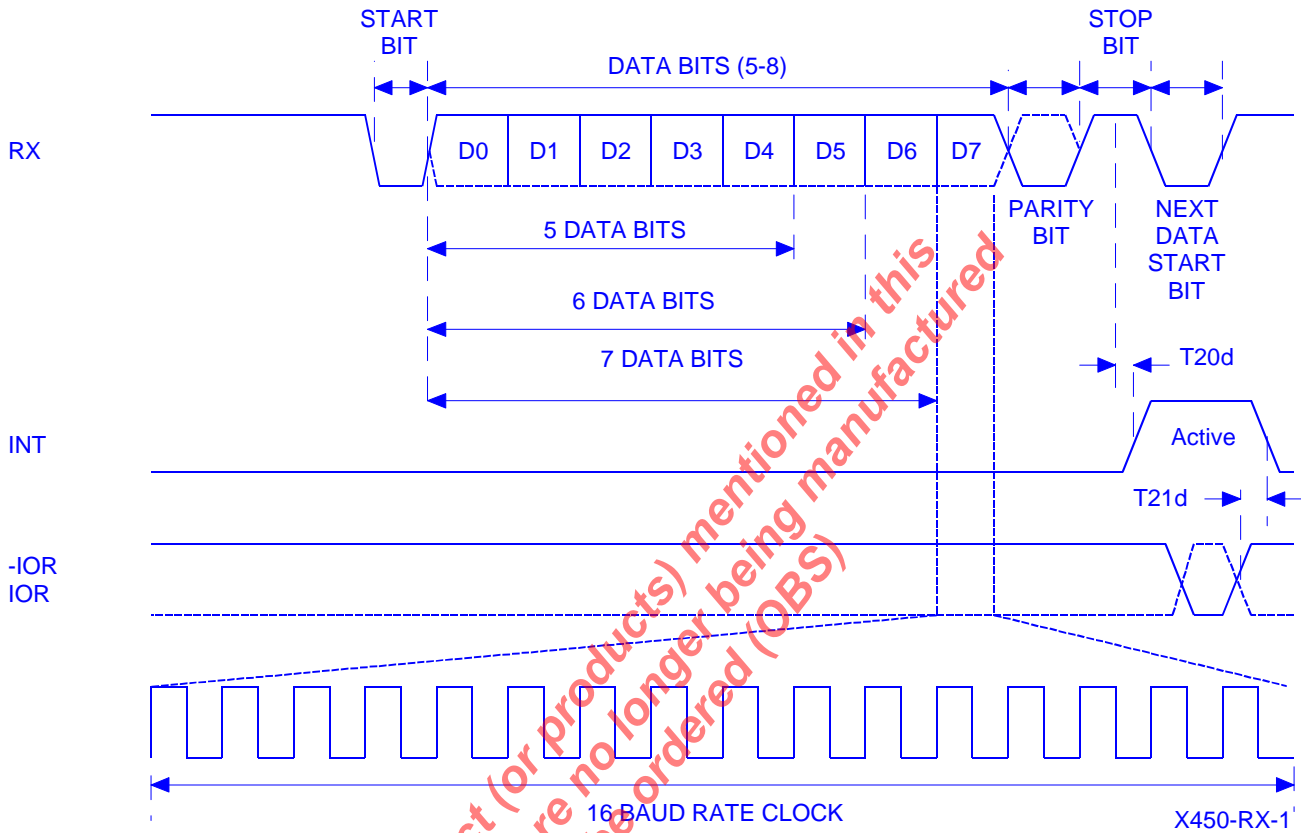

The product (or products) mentioned in this data sheet are no longer being manufactured and may not be ordered (OBS)

Receive timing

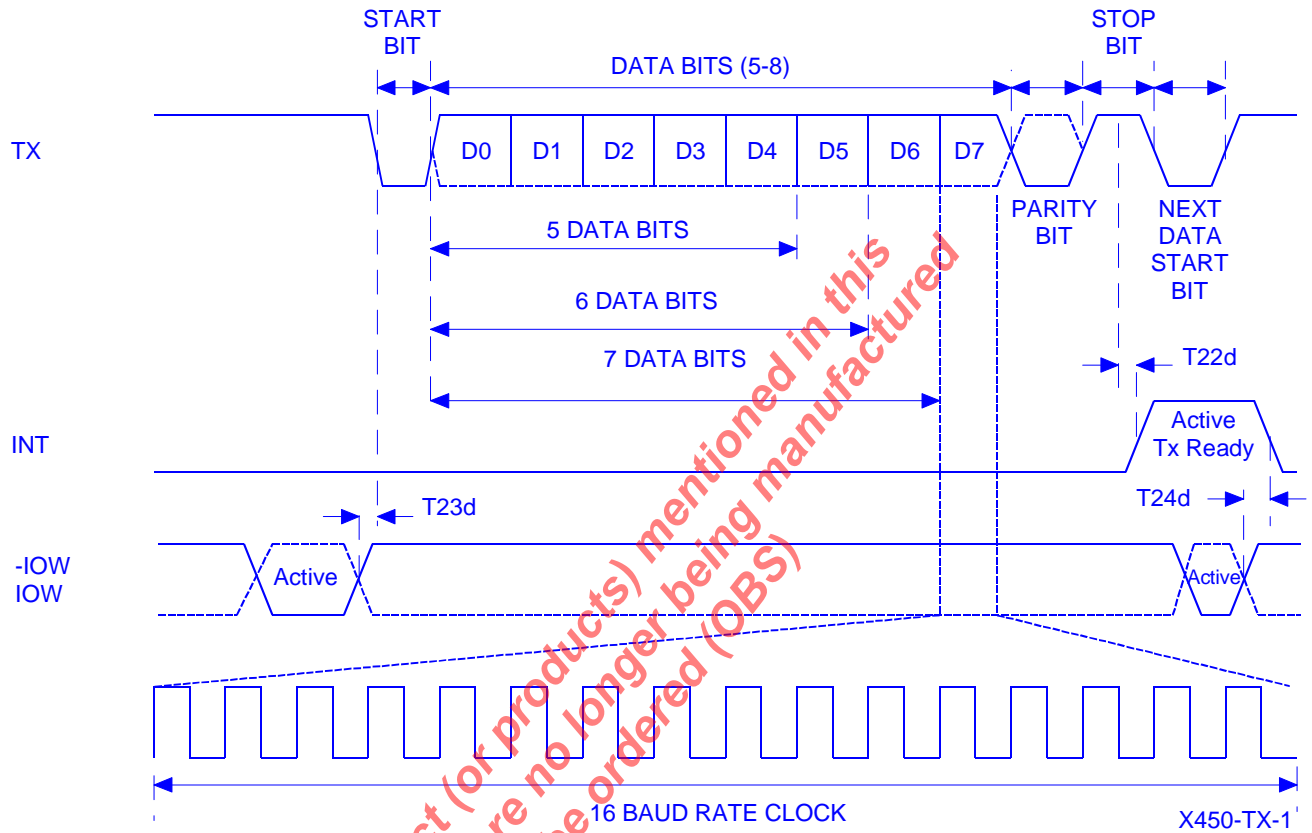

Transmit timing

The product (or products) mentioned in this data sheet are no longer being manufactured and may not be ordered (OBS)

PACKAGE OUTLINE DRAWING

44LEAD PLASTIC LEADED CHIP CARRIER
(PLCC)

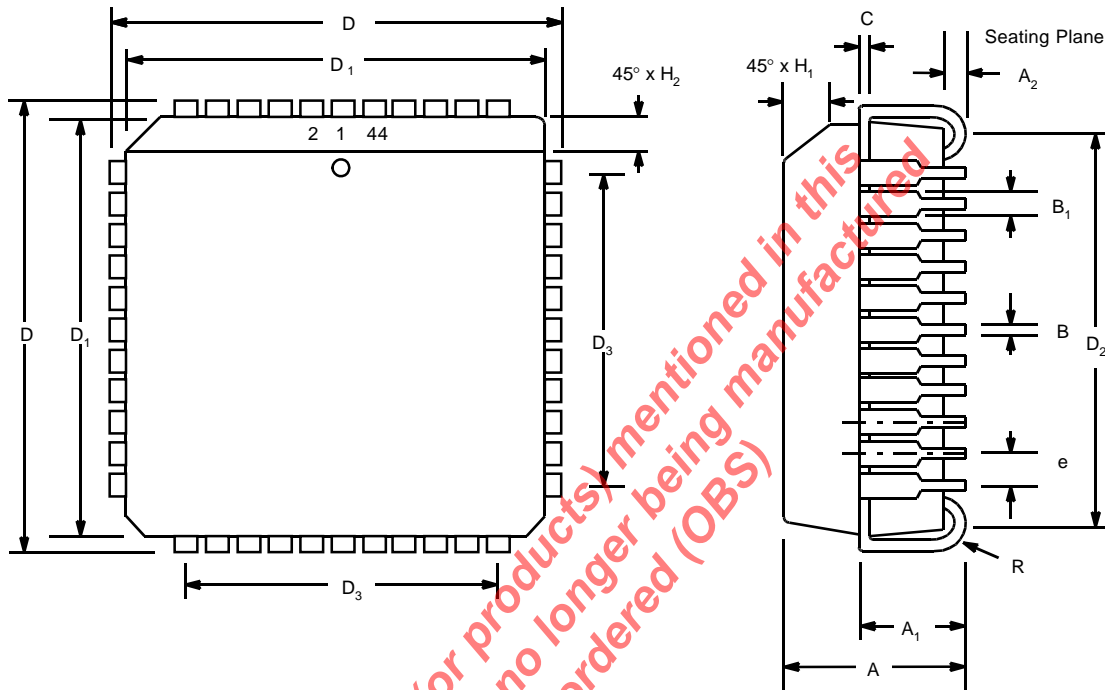

Note: The control dimension is the inch column

SYMBOL	INCHES		MILLIMETERS	
	MIN	MAX	MIN	MAX
A	0.165	0.180	4.19	4.57
A ₁	0.090	0.120	2.29	3.05
A ₂	0.020	-----	0.51	-----
B	0.013	0.021	0.33	0.53
B ₁	0.026	0.032	0.66	0.81
C	0.008	0.013	0.19	0.32
D	0.685	0.695	17.40	17.65
D ₁	0.650	0.656	16.51	16.66
D ₂	0.590	0.630	14.99	16.00
D ₃	0.500 typ		12.70 typ	
e	0.50 BSC		1.27BSC	
H ₁	0.042	0.056	1.07	1.42
H ₂	0.042	0.048	1.07	1.22
R	0.025	0.045	0.64	1.14

PACKAGE OUTLINE DRAWING

**48 LEAD THIN QUAD FLAT PACK
(TQFP)**

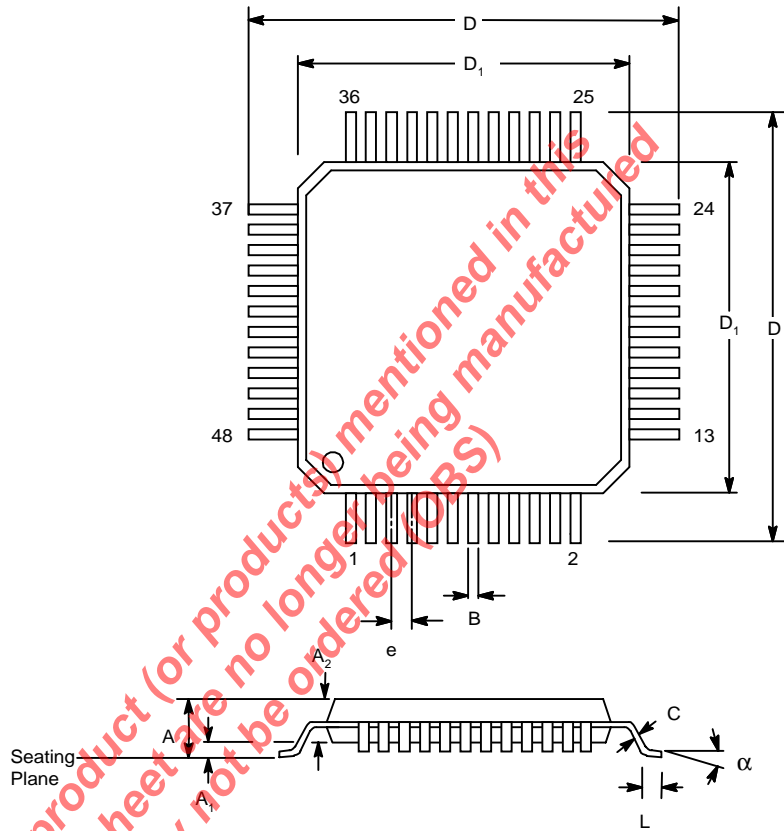

The product (or product) mentioned in this data sheet is no longer being manufactured (DS)

Note: The control dimension is the millimeter column

SYMBOL	INCHES		MILLIMETERS	
	MIN	MAX	MIN	MAX
A	0.039	0.047	1.00	1.20
A ₁	0.002	0.006	0.05	0.15
A ₂	0.037	0.041	0.95	1.05
B	0.007	0.011	0.17	0.27
C	0.004	0.008	0.09	0.20
D	0.346	0.362	8.80	9.20
D ₁	0.272	0.280	6.90	7.10
e	0.20 BSC		0.50BSC	
L	0.018	0.030	0.45	0.75
α	0°	7°	0°	7°

EXPLANATION OF DATA SHEET REVISIONS:

FROM	TO	CHANGES	DATE
4.10	4.20	Added revision history. Added Device Status to front page.	Sept 2003

NOTICE

EXAR Corporation reserves the right to make changes to the products contained in this publication in order to improve design, performance or reliability. EXAR Corporation assumes no responsibility for the use of any circuits described herein, conveys no license under any patent or other right, and makes no representation that the circuits are free of patent infringement. Charts and schedules contained here in are only for illustration purposes and may vary depending upon a user's specific application. While the information in this publication has been carefully checked; no responsibility, however, is assumed for inaccuracies.

EXAR Corporation does not recommend the use of any of its products in life support applications where the failure of the product can reasonably be expected to cause failure of the life support system or to significantly affect its safety or effectiveness. Products are not authorized for use in such applications unless EXAR Corporation receives, in writing, assurances to its satisfaction that: (a) the risk of injury or damage has been minimized; (b) the user assumes all such risks; (c) potential liability of EXAR Corporation is adequately protected under the circumstances.

Copyright 2003 EXAR Corporation
Datasheet September 2003

Send your UART technical inquiry with technical details to hotline: uarttechsupport@exar.com

Reproduction, in part or whole, without prior written consent of EXAR Corporation is prohibited.

Looking for pricing, stock, or lifecycle information?

Click below to explore more details on WIN SOURCE:

 [View ST16C450CP40-F on WIN SOURCE](#)

 [Exar Corporation](#) Information

Optimize Your Supply Chain with WIN SOURCE Solutions

-  Global Sourcing Solution
-  Obsolete Management
-  Cost Control Management
-  Shortage Management
-  Alternative Solution
-  Excess Inventory Management