



**THE DATASHEET OF
SPH1642HT5H-1**



WIDE BANDWIDTH, LOW NOISE, PRECISION TOP PORT SISONIC™ MICROPHONE



The SPH1642HT5H-1 is a miniature, high-performance, low power, matched sensitivity top port silicon microphone. Using Knowles' proven high performance SiSonic™ MEMS technology, the SPH1642HT5H-1 consists of an acoustic sensor, a low noise input buffer, and an output amplifier. These devices are suitable for applications such as cellphones, smart phones, laptop computers, sensors, digital still cameras, portable music recorders, and other portable electronic devices where excellent wideband audio performance and RF immunity are required.

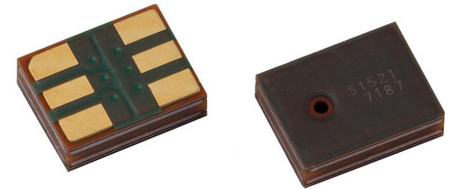

PRODUCT FEATURES

- Matched Sensitivity
- LGA Package
- Flat Frequency Response
- Low Current
- MaxRF Protection
- Top Port
- Ultra-Stable Performance
- Standard SMD Reflow
- Omnidirectional

TYPICAL APPLICATIONS

- Portable electronics
- Cellphones
- Laptop Computers
- Tablets
- Digital Still Cameras
- Portable Music Recorders

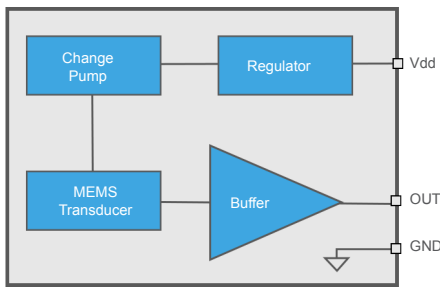

ABSOLUTE MAXIMUM RATINGS

Table 1: Absolute Maximum Ratings

Parameter	Absolute Maximum Rating	Units
Vdd to Ground	-0.3, +5.0	V
Out to Ground	-0.3, Vdd+0.3	V
Input Current to any pin	±5	mA
Storage Temperature	-40 to +100	°C
Operating Temperature	-30 to +100	°C

Stresses exceeding these "Absolute Maximum Ratings" may cause permanent damage to the device. These are stress ratings only. Functional operation at these or any other conditions beyond those indicated under "Acoustic & Electrical Specifications" is not implied. Exposure beyond those indicated under "Acoustic & Electrical Specifications" for extended periods may affect device reliability.



ACOUSTIC & ELECTRICAL SPECIFICATIONS¹

Table 2: General Microphone Specifications

Test Conditions: 23 ±2°C, 55±20% R.H., Vdd=1.8V, no load, unless otherwise indicated

Parameter	Symbol	Conditions	Min	Typ	Max	Units
Supply Voltage	Vdd		1.5	-	3.6	V
Supply Current	Idd	Vdd = 3.6V	-	132	185	µA
		Vdd = 1.8V	-	117	130	
Sensitivity	S	94 dB SPL @ 1 kHz	-39	-38	-37	dBV/Pa
Signal to Noise Ratio	SNR	94 dB SPL @ 1 kHz, A-weighted	-	65	-	dB(A)
Total Harmonic Distortion	THD	94 dB SPL @ 1 kHz, S = Typ, Rload > 2kΩ	-	0.25	-	%
		1% THD @ 1 kHz Vdd = 1.8v, S = Typ, Rload > 2kΩ	-	107	-	dB SPL
Acoustic Overload Point	AOP	10% THD @ 1 kHz, Vdd = 1.8v, S = Typ, Rload > 2kΩ	-	124	-	dB SPL
Low Frequency Rolloff	LFRO	-3dB relative to 1kHz	-	55	-	Hz
Power Supply Rejection Ratio	PSRR	200 mVpp sinewave @ 1kHz, Vdd = 1.8 v	-	77	-	dB
Power Supply Rejection	PSR+N	200 mVpp 7/8 duty cycle rectangular wave @ 217 Hz, Vdd = 1.8V, A-weighted	-	-102	-	dBV(A)
DC Output		Vdd = 1.8V	-	1.30	-	V
Output Impedance		@ 1 kHz	-		500	Ω
Sensitivity Drop		Vdd(min) ≤ Vdd ≤ Vdd(max)	-	-	±0.25	dB
Directivity			Omnidirectional			
Polarity		Increasing sound pressure	Increasing output voltage			

¹ Sensitivity and Supply Current are 100% tested.

APPLICATION NOTES

Figure 1: Typical Application Circuit

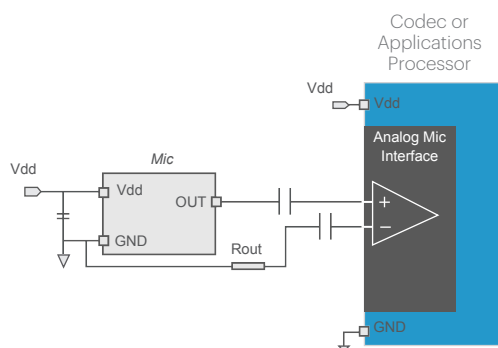

NOTES:

All Ground pins must be connected to ground.

Capacitors near the microphone should not contain Class 2 dielectrics due to their piezoelectric effects.

Detailed information on acoustic, mechanical, and system integration can be found in the latest SiSonic™ Design Guide application note.

PERFORMANCE CURVES

Test Conditions: Vdd=1.8V, no load, unless otherwise indicated

Figure 2: Typical Free Field Response Normalized to 1 kHz

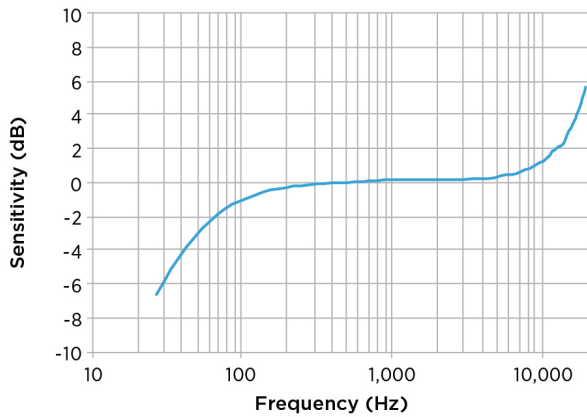

Figure 3: Typical PSRR vs Frequency

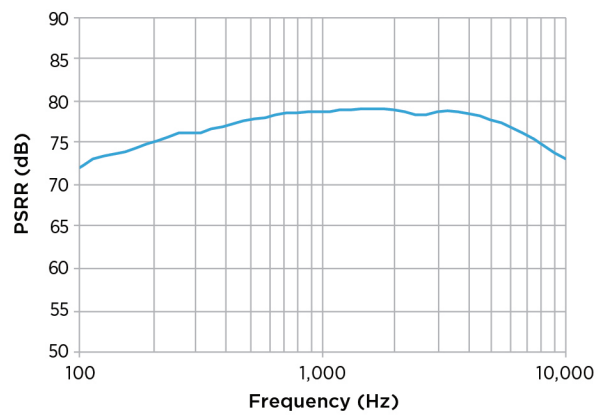

Figure 4: Typical THD vs SPL

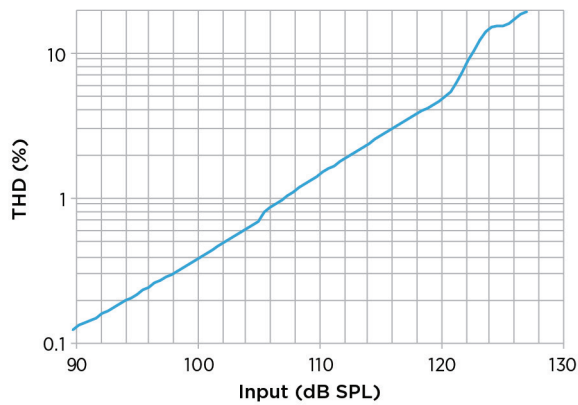

Figure 5: Typical Idd vs Vdd

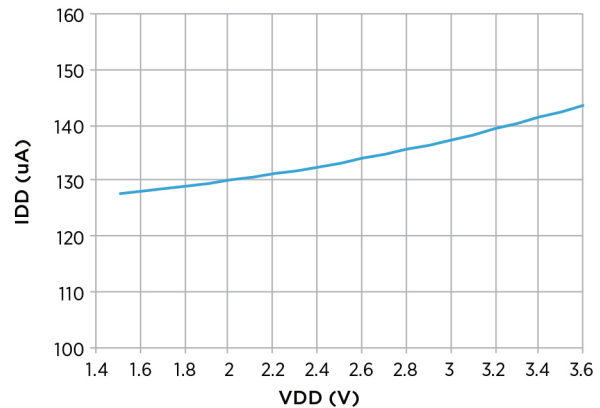

Figure 6: THD vs Frequency

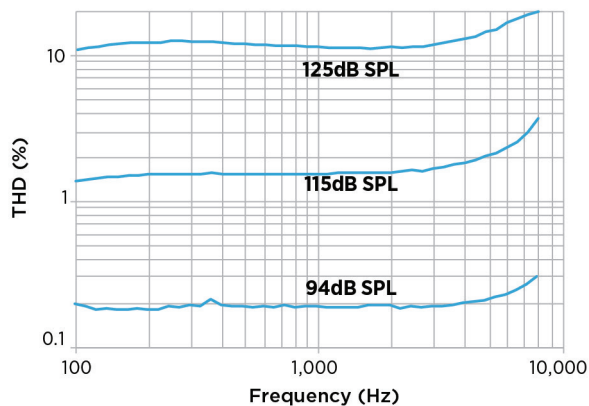
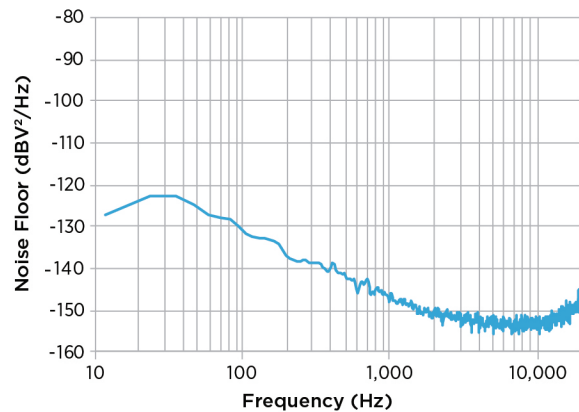
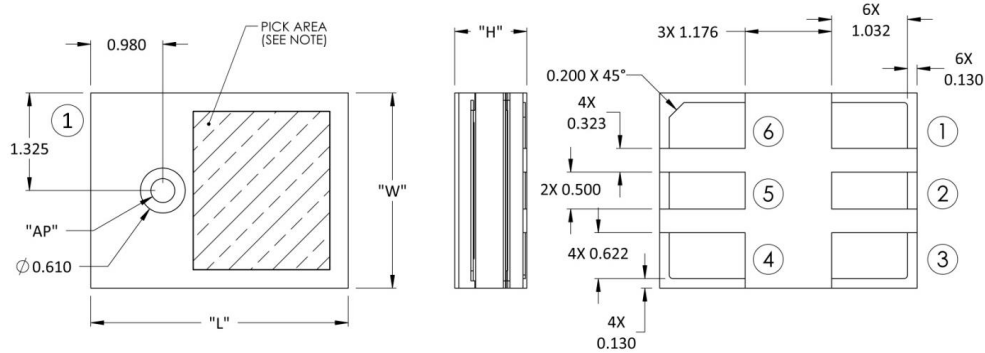

Figure 7: Noise Floor Power Spectral Density



MECHANICAL SPECIFICATIONS



Item	Dimension	Tolerance
Length (L)	3.50	±0.10
Width (W)	2.65	±0.10
Height (H)	1.00	±0.10
Acoustic Port (AP)	0.325	±0.10

Pin #	Pin Name	Type	Description
1	GROUND	Power	Ground
2	GROUND	Power	Ground
3	GROUND	Power	Ground
4	OUTPUT	Signal	Output Signal
5	TEST PIN (Knowles Internal Use)	N/A	Connect to Ground
6	Vdd	Power	Power Supply

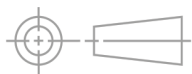

NOTES:

Pick Area only extends to 0.25 mm of any edge or hole unless otherwise specified.

Dimensions are in millimeters unless otherwise specified. Tolerance is ±0.15mm unless otherwise specified.

Detailed information on AP size considerations can be found in the latest SiSonic™ Design Guide application note.

Further optimizations based on application should be performed.

Example Land Pattern

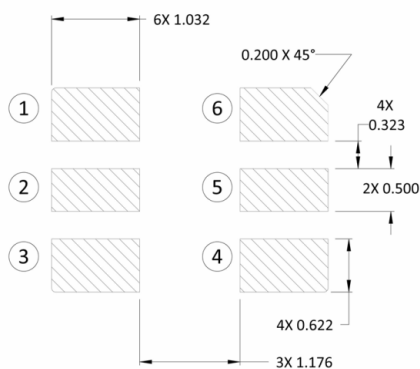

Example Solder Stencil Pattern

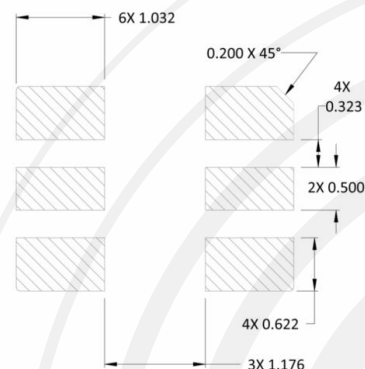

PACKAGING & MARKING DETAIL

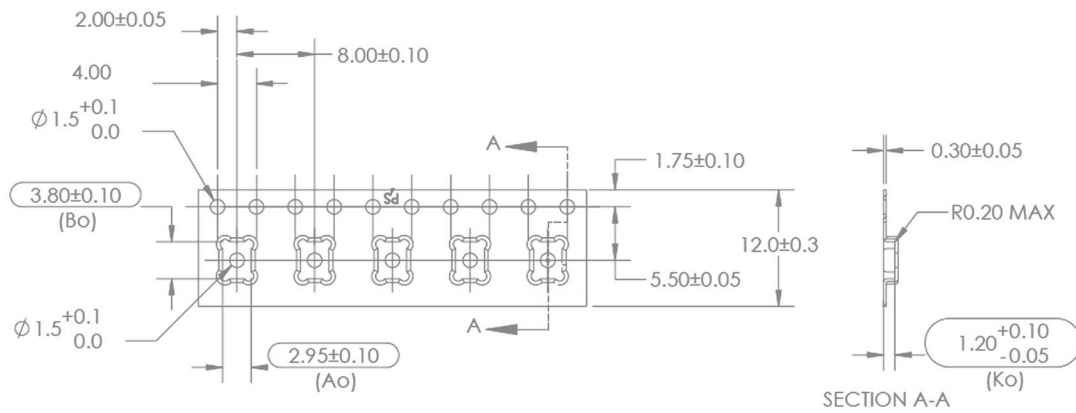

Model Number	Suffix	Reel Diameter	Quantity Per Reel
SPH1642HT5H-1	-8	13"	5,900

"o": orientation mark

Alpha Character A:

- "S": Knowles SiSonic™ Production
- "E": Knowles Engineering Samples
- "P": Knowles Prototype Samples

"JIN -NUMBER":

Unique Job Identification Number for product traceability

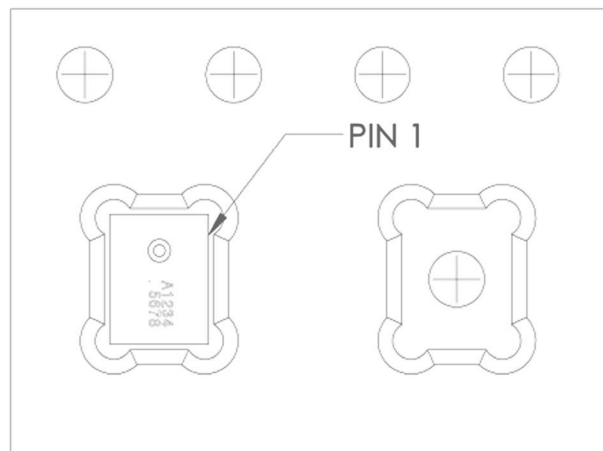

NOTES:

Dimensions are in millimeters unless otherwise specified.

Vacuum pickup only in the pick area indicated in Mechanical Specifications.

Tape & reel per EIA-481.

Labels applied directly to reel and external package.

Shelf life: Twelve (12) months when devices are to be stored in factory supplied, unopened ESD moisture sensitive bag under maximum environmental conditions of 30°C, 70% R.H.

RECOMMENDED REFLOW PROFILE

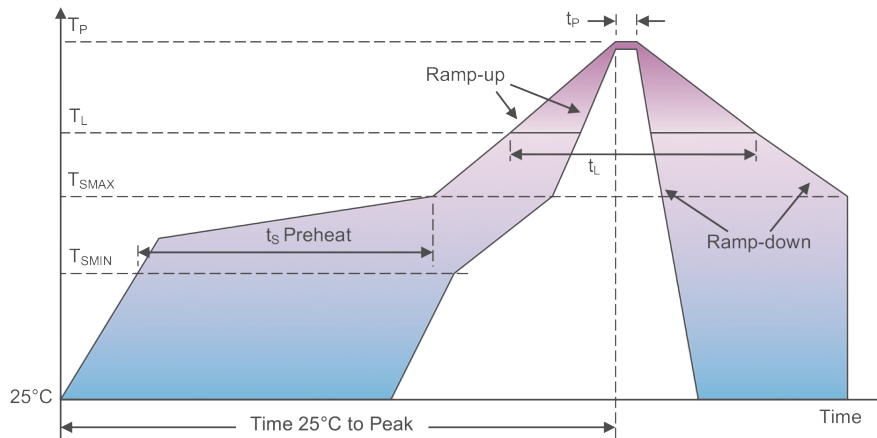

Profile Feature	Pb-Free
Average Ramp-up rate (T_{SMAX} to T_p)	3°C/second max.
Preheat <ul style="list-style-type: none"> • Temperature Min (T_{SMIN}) • Temperature Max (T_{SMAX}) • Time (T_{SMIN} to T_{SMAX}) (t_s) 	150°C 200°C 60-180 seconds
Time maintained above: <ul style="list-style-type: none"> • Temperature (TL) • Time (tL) 	217°C 60-150 seconds
Peak Temperature (TP)	260°C
Time within 5°C of actual Peak Temperature (tP)	20-40 seconds
Ramp-down rate (TP to TSMAX)	6°C/second max
Time 25°C to Peak Temperature	8 minutes max

NOTES:

Based on IPC/JDEC J-STD-020 Revision C.

All temperatures refer to topside of the package, measured on the package body surface.

ADDITIONAL NOTES:

- MSL (moisture sensitivity level) Class 1.
- Maximum of 3 reflow cycles is recommended.
- In order to minimize device damage:
 - Do not board wash or clean after the reflow process.
 - Do not brush board with or without solvents after the reflow process.
 - Do not directly expose to ultrasonic processing, welding, or cleaning.
 - Do not insert any object in port hole of device at any time.
 - Do not apply over 30 psi of air pressure into the port hole.
 - Do not pull a vacuum over port hole of the microphone.
 - Do not apply a vacuum when repacking into sealed bags at a rate faster than 0.5 atm/sec.

MATERIALS STATEMENT

Meets the requirements of the European RoHS directive 2011/65/EC as amended.

Meets the requirements of the industry standard IEC 61249-2-21:2003 for halogenated substances and Knowles Green Materials Standards Policy section on Halogen-Free.

Ozone depleting substances are not used in the product or the processes used to make the product, including compounds listed in Annex A, B, and C of the "Montreal Protocol on Substances That Deplete the Ozone Layer."

RELIABILITY SPECIFICATIONS

Test	Description
Reflow	5 reflow cycles with peak temperature of +260°C
High Temperature Storage	+105°C environment for 1,000 hours (IEC 68-2-2 Test Ba)
Low Temperature Storage	-40°C environment for 1,000 hours (IEC 68-2-1 Test Aa)
High Temperature Bias	+105°C environment while under bias for 1,000 hours (IEC 68-2-2 Test Ba)
Low Temperature Bias	-40°C environment while under bias for 1,000 hours (IEC 68-2-1 Test Aa)
Temperature/Humidity Bias	+85°C/85% R.H. environment while under bias for 1,000 hours (JESD22-A101A-B)
Thermal Shock	100 cycles of air-air thermal shock from -40°C to +125°C with 15 minute soaks (IEC 68-2-4)
Vibration	12 minutes in each X, Y, Z axis from 20 to 2,000 Hz with peak acceleration of 20 G (MIL 883E, Method 2007.2,A)
Mechanical Shock	3 pulses of 10,000 G in each of the X, Y, and Z directions (IEC 68-2-27 Test Ea)
ESD-HBM	3 discharges of ±2kV direct contact to I/O pins (MIL 883E, Method 3015.7)
ESD-HBM (LID/GND)	3 discharges of ±8kV direct contact to lid while unit is grounded (MIL 883E, Method 3015.7)
ESD-MM	3 discharges of ±200V direct contact to IO pins (ESD STM5.2)

NOTES:

Microphones must meet all acoustic and electrical specifications before and after reliability testing.

After 3 reflow cycles, the sensitivity of the microphones shall not deviate more than 1 dB from its initial value.

SPECIFICATION REVISIONS

Revision	Specification Changes	Date
A	Initial Release ECR#15-181	5/21/15
B	Changed THD to 0.25% ECR#15-129	7/21/2015
C	Changed microphone photograph ECR#16-1240	10/27/2016
D	Update Pin description ECR #17-1656	5/15/17
E	Update Temperature range ECR#17-2010	11/13/17

Information contained herein is subject to change without notice. It may be used by a party at their own discretion and risk. We do not guarantee any results or assume any liability in connection with its use. This publication is not to be taken as a license to operate under any existing patents.

Looking for pricing, stock, or lifecycle information?

Click below to explore more details on WIN SOURCE:

 [View SPH1642HT5H-1 on WIN SOURCE](#)

 [Knowles](#) Information

Optimize Your Supply Chain with WIN SOURCE Solutions

-  Global Sourcing Solution
-  Obsolete Management
-  Cost Control Management
-  Shortage Management
-  Alternative Solution
-  Excess Inventory Management