



**THE DATASHEET OF
SN74LVC2T45DCTTG4**



SN74LVC2T45 Dual-Bit Dual-Supply Bus Transceiver

With Configurable Voltage Translation

1 Features

- Fully configurable dual-rail design allows each port to operate over the full 1.65-V to 5.5-V power-supply range
- V_{CC} isolation feature – if either V_{CC} input is at GND, both ports are in the high-impedance state
- DIR input circuit referenced to V_{CCA}
- Low power consumption, 4- μ A maximum I_{CC}
- Available in the Texas Instruments NanoFree™ package
- ± 24 -mA output drive at 3.3 V
- I_{off} supports Partial-Power-Down mode operation
- Maximum data rates:
 - 420 Mbps (3.3-V to 5-V translation)
 - 210 Mbps (translate to 3.3 V)
 - 140 Mbps (translate to 2.5 V)
 - 75 Mbps (translate to 1.8 V)
- Latch-up performance exceeds 100 mA per JESD 78, Class II
- ESD protection exceeds JESD 22
 - 4000-V Human-Body Model (A114-A)
 - 200-V Machine Model (A115-A)
 - 1000-V Charged-Device Model (C101)

2 Applications

- Personal electronic
- Industrial
- Enterprise
- Telecom

3 Description

This dual-bit noninverting bus transceiver uses two separate configurable power-supply rails. The A port is designed to track V_{CCA} . V_{CCA} accepts any supply voltage from 1.65 V to 5.5 V. The B port is designed to track V_{CCB} . V_{CCB} accepts any supply voltage from 1.65 V to 5.5 V. This allows for universal low-voltage bidirectional translation between any of the 1.8-V, 2.5-V, 3.3-V, and 5-V voltage nodes.

The SN74LVC2T45 is designed for asynchronous communication between two data buses. The logic levels of the direction-control (DIR) input activate either the B-port outputs or the A-port outputs. The device transmits data from the A bus to the B bus when the B-port outputs are activated, and from the B bus to the A bus when the A-port outputs are activated. The input circuitry on both A and B ports are always active and must have a logic HIGH or LOW level applied to prevent excess I_{CC} and I_{CCZ} .

The SN74LVC2T45 is designed so that V_{CCA} supplies the DIR input circuit. This device is fully specified for partial-power-down applications using I_{off} . The I_{off} circuitry disables the outputs, preventing damaging current backflow through the device when it is powered down.

The V_{CC} isolation feature ensures that if either V_{CC} input is at GND, both ports are in the high-impedance state.

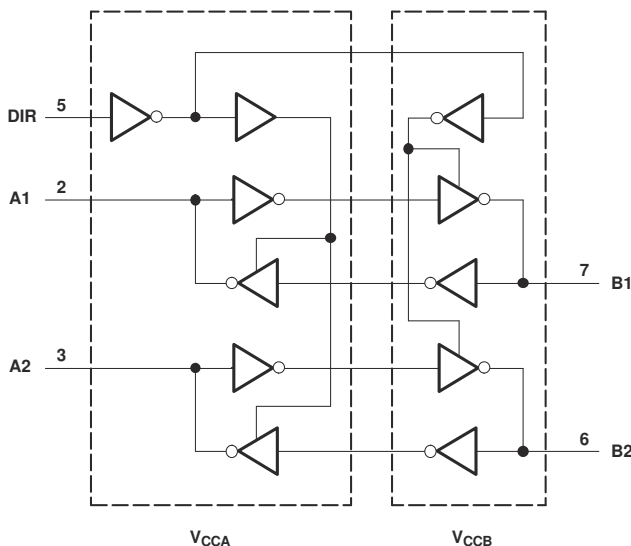

Functional Block Diagram

Package Information⁽¹⁾

PART NUMBER	PACKAGE	BODY SIZE (NOM)
SN74LVC2T45	DCT (SM8, 8)	2.95 mm × 2.80 mm
	DCU (VSSOP, 8)	2.30 mm × 2.00 mm
	YZP (DSBGA, 8)	1.89 mm × 0.89 mm

- (1) For all available packages, see the orderable addendum at the end of the data sheet.



Table of Contents

1 Features	1	8.2 Functional Block Diagram.....	14
2 Applications	1	8.3 Feature Description.....	14
3 Description	1	8.4 Device Functional Modes.....	15
4 Revision History	2	9 Application and Implementation	16
5 Pin Configuration and Functions	3	9.1 Application Information.....	16
6 Specifications	4	9.2 Typical Applications.....	16
6.1 Absolute Maximum Ratings.....	4	10 Power Supply Recommendations	20
6.2 ESD Ratings.....	4	10.1 Power-Up Considerations.....	20
6.3 Recommended Operating Conditions.....	4	11 Layout	21
6.4 Thermal Information.....	5	11.1 Layout Guidelines.....	21
6.5 Electrical Characteristics.....	6	11.2 Layout Example.....	21
6.6 Switching Characteristics: $V_{CCA} = 1.8\text{ V} \pm 0.15\text{ V}$	7	12 Device and Documentation Support	22
6.7 Switching Characteristics: $V_{CCA} = 2.5\text{ V} \pm 0.2\text{ V}$	7	12.1 Documentation Support.....	22
6.8 Switching Characteristics: $V_{CCA} = 3.3\text{ V} \pm 0.3\text{ V}$	8	12.2 Receiving Notification of Documentation Updates..	22
6.9 Switching Characteristics: $V_{CCA} = 5\text{ V} \pm 0.5\text{ V}$	8	12.3 Support Resources.....	22
6.10 Operating Characteristics.....	9	12.4 Trademarks.....	22
6.11 Typical Characteristics.....	10	12.5 Electrostatic Discharge Caution.....	22
7 Parameter Measurement Information	13	12.6 Glossary.....	22
8 Detailed Description	14	13 Mechanical, Packaging, and Orderable Information	22
8.1 Overview.....	14		

4 Revision History

NOTE: Page numbers for previous revisions may differ from page numbers in the current version.

Changes from Revision L (October 2022) to Revision M (October 2022)	Page
• Changed the T_A operating free-air temperature back to 85°C	4
Changes from Revision K (June 2017) to Revision L (October 2022)	Page
• Updated the numbering format for tables, figures, and cross-references throughout the document.....	1
• Updated the thermals in the <i>Thermal Information</i> section.....	5
• Extended the minimum specifications for lower delays in the <i>Switching Characteristics</i> sections.....	7
Changes from Revision J (October 2014) to Revision K (June 2017)	Page
• Changed data sheet title.....	1
• Added Junction temperature, T_J in <i>Absolute Maximum Ratings</i>	4
Changes from Revision I (March 2007) to Revision J (October 2014)	Page
• Added <i>Pin Configuration and Functions</i> section, <i>ESD Ratings</i> table, <i>Feature Description</i> section, <i>Device Functional Modes</i> , <i>Application and Implementation</i> section, <i>Power Supply Recommendations</i> section, <i>Layout</i> section, <i>Device and Documentation Support</i> section, and <i>Mechanical, Packaging, and Orderable Information</i> section	1

5 Pin Configuration and Functions

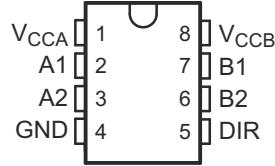

Figure 5-1. DCT or DCU Package, 8-Pin SM8 or VSSOP (Top View)

Table 5-1. Pin Functions: DCT, DCU

PIN		TYPE ⁽¹⁾	DESCRIPTION
NAME	NO.		
V _{CCA}	1	P	A-port supply voltage. $1.65\text{ V} \leq V_{CCA} \leq 5.5\text{ V}$
A1	2	I/O	Input/output A1. Referenced to V _{CCA}
A2	3	I/O	Input/output A2. Referenced to V _{CCA}
GND	4	G	Ground
DIR	5	I	Direction control signal
B2	6	I/O	Input/output B2. Referenced to V _{CCB}
B1	7	I/O	Input/output B1. Referenced to V _{CCB}
V _{CCB}	8	P	B-port supply voltage. $1.65\text{ V} \leq V_{CCB} \leq 5.5\text{ V}$

(1) I = input, O = output, P = power, G = ground

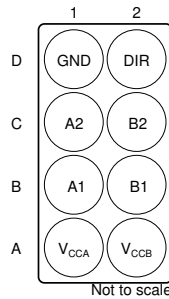

Figure 5-2. YZP Package, 8-Pin DSGBA (Bottom View)

Table 5-2. Pin Functions: YZP

PIN		TYPE ⁽¹⁾	DESCRIPTION
NO.	NAME		
A1	V _{CCA}	P	A-port supply voltage. $1.65\text{ V} \leq V_{CCA} \leq 5.5\text{ V}$
A2	V _{CCB}	P	B-port supply voltage. $1.65\text{ V} \leq V_{CCB} \leq 5.5\text{ V}$
B1	A1	I/O	Input/output A1. Referenced to V _{CCA}
B2	B1	I/O	Input/output B1. Referenced to V _{CCB}
C1	A2	I/O	Input/output A2. Referenced to V _{CCA}
C2	B2	I/O	Input/output B2. Referenced to V _{CCB}
D1	GND	G	Ground
D2	DIR	I	Direction control signal

(1) I = input, O = output, P = power, G = ground

6 Specifications

6.1 Absolute Maximum Ratings

over operating free-air temperature range (unless otherwise noted)⁽¹⁾

			MIN	MAX	UNIT
V _{CCA}	Supply voltage		-0.5	6.5	V
V _{CBB}					
V _I	Input voltage ⁽²⁾		-0.5	6.5	V
V _O	Voltage range applied to any output in the high-impedance or power-off state ⁽²⁾		-0.5	6.5	V
V _O	Voltage range applied to any output in the high or low state ^{(2) (3)}	A port	-0.5	V _{CCA} + 0.5	V
		B port	-0.5	V _{CBB} + 0.5	
I _{IK}	Input clamp current	V _I < 0	-50		mA
I _{OK}	Output clamp current	V _O < 0	-50		mA
I _O	Continuous output current		-50	50	mA
	Continuous current through V _{CC} or GND		-100	100	
T _J	Junction temperature			150	°C
T _{stg}	Storage temperature		-65	150	°C

- (1) Stresses beyond those listed under *Absolute Maximum Ratings* may cause permanent damage to the device. These are stress ratings only, which do not imply functional operation of the device at these or any other conditions beyond those indicated under *Recommended Operating Conditions*. Exposure to absolute-maximum-rated conditions for extended periods may affect device reliability.
- (2) The input and output negative-voltage ratings may be exceeded if the input and output clamp-current ratings are observed.
- (3) The value of V_{CC} is provided in the recommended operating conditions table.

6.2 ESD Ratings

			VALUE	UNIT
V _(ESD)	Electrostatic discharge	Human body model (HBM), per ANSI/ESDA/JEDEC JS-001 ⁽¹⁾	±4000	V
		Charged device model (CDM), per ANSI/ESDA/JEDEC JS-002 ⁽²⁾	±1000	

- (1) JEDEC document JEP155 states that 500-V HBM allows safe manufacturing with a standard ESD control process.
- (2) JEDEC document JEP157 states that 250-V CDM allows safe manufacturing with a standard ESD control process.

6.3 Recommended Operating Conditions

over operating free-air temperature range (unless otherwise noted)^{(1) (2) (3)}

			V _{CCI}	V _{CCO}	MIN	MAX	UNIT
V _{CCA}	Supply voltage				1.65	5.5	V
V _{CBB}					1.65	5.5	
V _{IH}	High-level input voltage	Data inputs ⁽⁴⁾	1.65 V to 1.95 V		V _{CCI} × 0.65		V
			2.3 V to 2.7 V		1.7		
			3 V to 3.6 V		2		
			4.5 V to 5.5 V		V _{CCI} × 0.7		
V _{IL}	Low-level input voltage	Data inputs ⁽⁴⁾	1.65 V to 1.95 V		V _{CCI} × 0.35		V
			2.3 V to 2.7 V		0.7		
			3 V to 3.6 V		0.8		
			4.5 V to 5.5 V		V _{CCI} × 0.3		
V _{IH}	High-level input voltage	DIR (referenced to V _{CCA}) ⁽⁵⁾	1.65 V to 1.95 V		V _{CCA} × 0.65		V
			2.3 V to 2.7 V		1.7		
			3 V to 3.6 V		2		
			4.5 V to 5.5 V		V _{CCA} × 0.7		

6.3 Recommended Operating Conditions (continued)

over operating free-air temperature range (unless otherwise noted)^{(1) (2) (3)}

		V _{CCI}	V _{CCO}	MIN	MAX	UNIT
V _{IL}	Low-level input voltage	DIR (referenced to V _{CCA}) ⁽⁵⁾	1.65 V to 1.95 V		V _{CCA} × 0.35	V
			2.3 V to 2.7 V		0.7	
			3 V to 3.6 V		0.8	
			4.5 V to 5.5 V		V _{CCA} × 0.3	
V _I	Input voltage			0	5.5	V
V _O	Output voltage			0	V _{CCO}	V
I _{OH}	High-level output current		1.65 V to 1.95 V		–4	mA
			2.3 V to 2.7 V		–8	
			3 V to 3.6 V		–24	
			4.5 V to 5.5 V		–32	
I _{OL}	Low-level output current		1.65 V to 1.95 V		4	mA
			2.3 V to 2.7 V		8	
			3 V to 3.6 V		24	
			4.5 V to 5.5 V		32	
Δt/Δv	Input transition rise or fall rate	Data inputs	1.65 V to 1.95 V		20	ns/V
			2.3 V to 2.7 V		20	
			3 V to 3.6 V		10	
			4.5 V to 5.5 V		5	
		Control input	1.65 V to 5.5 V		5	
T _A	Operating free-air temperature			–40	85	°C

- (1) V_{CCI} is the V_{CC} associated with the input port.
- (2) V_{CCO} is the V_{CC} associated with the output port.
- (3) All unused data inputs of the device must be held at V_{CCI} or GND to ensure proper device operation. See [Implications of Slow or Floating CMOS Inputs](#), SCBA004.
- (4) For V_{CCI} values not specified in the data sheet, V_{IH} min = V_{CCI} × 0.7 V, V_{IL} max = V_{CCI} × 0.3 V.
- (5) For V_{CCI} values not specified in the data sheet, V_{IH} min = V_{CCA} × 0.7 V, V_{IL} max = V_{CCA} × 0.3 V.

6.4 Thermal Information

THERMAL METRIC ⁽¹⁾		SN74LVC2T45			UNIT
		DCU	DCT	YZP	
		8 PINS			
R _{θJA}	Junction-to-ambient thermal resistance	246.4	195.3	105.8	°C/W
R _{θJC(top)}	Junction-to-case (top) thermal resistance	95.4	106	1.6	°C/W
R _{θJB}	Junction-to-board thermal resistance	157.8	110.8	10.8	°C/W
Ψ _{JT}	Junction-to-top characterization parameter	37	38.3	3.1	°C/W
Ψ _{JB}	Junction-to-board characterization parameter	156.9	109.3	10.8	°C/W

- (1) For more information about traditional and new thermal metrics, see the [Semiconductor and IC Package Thermal Metrics](#) application report.

6.5 Electrical Characteristics

over recommended operating free-air temperature range (unless otherwise noted)^{(1) (2)}

PARAMETER	TEST CONDITIONS		V _{CCA}	V _{CCB}	T _A = 25°C			–40°C to +85°C		UNIT	
					MIN	TYP	MAX	MIN	MAX		
V _{OH}		V _I = V _{IH}	I _{OH} = –100 μA	1.65 V to 4.5 V	1.65 V to 4.5 V				V _{CCO} – 0.1	V	
			I _{OH} = –4 mA	1.65 V	1.65 V			1.2			
			I _{OH} = –8 mA	2.3 V	2.3 V			1.9			
			I _{OH} = –24 mA	3 V	3 V			2.4			
			I _{OH} = –32 mA	4.5 V	4.5 V			3.8			
V _{OL}		V _I = V _{IL}	I _{OL} = 100 μA	1.65 V to 4.5 V	1.65 V to 4.5 V				0.1	V	
			I _{OL} = 4 mA	1.65 V	1.65 V			0.45			
			I _{OL} = 8 mA	2.3 V	2.3 V			0.3			
			I _{OL} = 24 mA	3 V	3 V			0.55			
			I _{OL} = 32 mA	4.5 V	4.5 V			0.55			
I _I	DIR	V _I = V _{CCA} or GND	1.65 V to 5.5 V	1.65 V to 5.5 V				±1	±2	μA	
I _{off}	A port	V _I or V _O = 0 to 5.5 V	0 V	0 to 5.5 V				±1	±2	μA	
	B port		0 to 5.5 V	0 V			±1	±2			
I _{OZ}	A or B port	V _O = V _{CCO} or GND	1.65 V to 5.5 V	1.65 V to 5.5 V				±1	±2	μA	
I _{CCA}		V _I = V _{CCI} or GND, I _O = 0	1.65 V to 5.5 V	1.65 V to 5.5 V					3	μA	
			5 V	0 V				2			
			0 V	5 V				–2			
I _{CCB}		V _I = V _{CCI} or GND, I _O = 0	1.65 V to 5.5 V	1.65 V to 5.5 V					3	μA	
			5 V	0 V				–2			
			0 V	5 V				2			
I _{CCA} + I _{CCB} (see Table 10-1)		V _I = V _{CCI} or GND, I _O = 0	1.65 V to 5.5 V	1.65 V to 5.5 V					4	μA	
ΔI _{CCA}	A port	One A port at V _{CCA} – 0.6 V, DIR at V _{CCA} , B port = open	3 V to 5.5 V	3 V to 5.5 V						50	μA
	DIR										
ΔI _{CCB}	B port	One B port at V _{CCB} – 0.6 V, DIR at GND, A port = open	3 V to 5.5 V	3 V to 5.5 V						50	μA
C _I	DIR	V _I = V _{CCA} or GND	3.3 V	3.3 V			2.5				pF
C _{io}	A or B port	V _O = V _{CCA/B} or GND	3.3 V	3.3 V			6				pF

(1) V_{CCO} is the V_{CC} associated with the output port.

(2) V_{CCI} is the V_{CC} associated with the input port.

6.6 Switching Characteristics: $V_{CCA} = 1.8\text{ V} \pm 0.15\text{ V}$

over recommended operating free-air temperature range, $V_{CCA} = 1.8\text{ V} \pm 0.15\text{ V}$ (unless otherwise noted) (see [Figure 7-1](#))

PARAMETER	FROM (INPUT)	TO (OUTPUT)	$V_{CCB} = 1.8\text{ V} \pm 0.15\text{ V}$		$V_{CCB} = 2.5\text{ V} \pm 0.2\text{ V}$		$V_{CCB} = 3.3\text{ V} \pm 0.3\text{ V}$		$V_{CCB} = 5\text{ V} \pm 0.5\text{ V}$		UNIT
			MIN	MAX	MIN	MAX	MIN	MAX	MIN	MAX	
t_{PLH}	A	B	3	17.7	2.2	10.3	1.7	8.3	1.4	7.2	ns
t_{PHL}			2.8	14.3	2.2	8.5	1.8	7.1	1.7	7	
t_{PLH}	B	A	3	17.7	2.3	16	2.1	15.5	1.9	15.1	ns
t_{PHL}			2.8	14.3	2.1	12.9	2	12.6	1.8	12.2	
t_{PHZ}	DIR	A	5.5	30.9	5.5	30.5	5.5	30.5	5.5	29.3	ns
t_{PLZ}			4.3	19.7	4.2	19.6	4.1	19.5	4	19.4	
t_{PHZ}	DIR	B	6	27.9	5	14.9	5	11.3	4.1	8.6	ns
t_{PLZ}			5	19.5	3.9	12.6	4.3	9.7	2.1	7.1	
$t_{PZH}^{(1)}$	DIR	A	37.2		28.6		25.2		22.2		ns
$t_{PZL}^{(1)}$			42.2		27.8		23.9		20.8		
$t_{PZH}^{(1)}$	DIR	B	37.4		29.9		27.8		26.6		ns
$t_{PZL}^{(1)}$			45.2		39		37.6		36.3		

(1) The enable time is a calculated value, derived using the formula shown in the [Enable Times](#) section.

6.7 Switching Characteristics: $V_{CCA} = 2.5\text{ V} \pm 0.2\text{ V}$

over recommended operating free-air temperature range, $V_{CCA} = 2.5\text{ V} \pm 0.2\text{ V}$ (unless otherwise noted) (see [Figure 7-1](#))

PARAMETER	FROM (INPUT)	TO (OUTPUT)	$V_{CCB} = 1.8\text{ V} \pm 0.15\text{ V}$		$V_{CCB} = 2.5\text{ V} \pm 0.2\text{ V}$		$V_{CCB} = 3.3\text{ V} \pm 0.3\text{ V}$		$V_{CCB} = 5\text{ V} \pm 0.5\text{ V}$		UNIT
			MIN	MAX	MIN	MAX	MIN	MAX	MIN	MAX	
t_{PLH}	A	B	2.3	16	1.5	8.5	1.3	6.4	1.1	5.1	ns
t_{PHL}			2.1	12.9	1.4	7.5	1.3	5.4	0.9	4.6	
t_{PLH}	B	A	2.2	10.3	1.5	8.5	1.4	8	1	7.5	ns
t_{PHL}			2.2	8.5	1.4	7.5	1.3	7	0.9	6.2	
t_{PHZ}	DIR	A	4.2	17.1	4.2	16.8	4.1	16.8	4.1	16.5	ns
t_{PLZ}			3.2	12.6	3.2	12.5	3.2	12.3	3	12.3	
t_{PHZ}	DIR	B	6	27.9	4.7	13.9	4.7	10.5	3.5	7.6	ns
t_{PLZ}			4.2	18.9	3.6	11.2	3.6	8.9	1.4	6.2	
$t_{PZH}^{(1)}$	DIR	A	29.2		19.7		16.9		13.7		ns
$t_{PZL}^{(1)}$			36.4		21.4		17.5		13.8		
$t_{PZH}^{(1)}$	DIR	B	28.6		21		18.7		17.4		ns
$t_{PZL}^{(1)}$			30		24.3		22.2		21.1		

(1) The enable time is a calculated value, derived using the formula shown in the [Enable Times](#) section.

6.8 Switching Characteristics: $V_{CCA} = 3.3\text{ V} \pm 0.3\text{ V}$

over recommended operating free-air temperature range, $V_{CCA} = 3.3\text{ V} \pm 0.3\text{ V}$ (unless otherwise noted) (see [Figure 7-1](#))

PARAMETER	FROM (INPUT)	TO (OUTPUT)	$V_{CCB} = 1.8\text{ V} \pm 0.15\text{ V}$		$V_{CCB} = 2.5\text{ V} \pm 0.2\text{ V}$		$V_{CCB} = 3.3\text{ V} \pm 0.3\text{ V}$		$V_{CCB} = 5\text{ V} \pm 0.5\text{ V}$		UNIT
			MIN	MAX	MIN	MAX	MIN	MAX	MIN	MAX	
t_{PLH}	A	B	2.1	15.5	1.4	8	0.7	5.6	0.7	4.4	ns
t_{PHL}			2	12.6	1.3	7	0.8	5	0.7	4	
t_{PLH}	B	A	1.7	8.3	1.3	6.4	0.7	5.8	0.6	5.4	ns
t_{PHL}			1.8	7.1	1.3	5.4	0.8	5	0.7	4.5	
t_{PHZ}	DIR	A	4.5	10.9	4.5	10.8	4.4	10.8	4.4	10.4	ns
t_{PLZ}			3.4	8.4	3.7	8.4	3.9	8.1	3.3	7.8	
t_{PHZ}	DIR	B	5.7	27.3	4.7	13.7	4.7	10.4	2.9	7.4	ns
t_{PLZ}			4.5	17.7	3.5	11.3	4.3	8.3	1	5.6	
$t_{PZH}^{(1)}$	DIR	A	26		17.7		14.1		11		ns
$t_{PZL}^{(1)}$			34.4		19.1		15.4		11.9		
$t_{PZH}^{(1)}$	DIR	B	23.9		16.4		13.9		12.2		ns
$t_{PZL}^{(1)}$			23.5		17.8		15.8		14.4		

(1) The enable time is a calculated value, derived using the formula shown in the [Enable Times](#) section.

6.9 Switching Characteristics: $V_{CCA} = 5\text{ V} \pm 0.5\text{ V}$

over recommended operating free-air temperature range, $V_{CCA} = 5\text{ V} \pm 0.5\text{ V}$ (unless otherwise noted) (see [Figure 7-1](#))

PARAMETER	FROM (INPUT)	TO (OUTPUT)	$V_{CCB} = 1.8\text{ V} \pm 0.15\text{ V}$		$V_{CCB} = 2.5\text{ V} \pm 0.2\text{ V}$		$V_{CCB} = 3.3\text{ V} \pm 0.3\text{ V}$		$V_{CCB} = 5\text{ V} \pm 0.5\text{ V}$		UNIT
			MIN	MAX	MIN	MAX	MIN	MAX	MIN	MAX	
t_{PLH}	A	B	1.9	15.1	1	7.5	0.6	5.4	0.5	3.9	ns
t_{PHL}			1.8	12.2	0.9	6.2	0.7	4.5	0.5	3.5	
t_{PLH}	B	A	1.4	7.2	1	5.1	0.7	4.4	0.5	3.9	ns
t_{PHL}			1.7	7	0.9	4.6	0.7	4	0.5	3.5	
t_{PHZ}	DIR	A	2.9	8.2	2.9	7.9	2.8	7.9	2.2	7.8	ns
t_{PLZ}			1.4	6.9	1.3	6.7	0.7	6.7	0.7	6.6	
t_{PHZ}	DIR	B	5.8	26.1	4.4	13.9	4.4	10.1	1.3	7.3	ns
t_{PLZ}			4.7	16.9	3.3	11	4	7.7	1	5.6	
$t_{PZH}^{(1)}$	DIR	A	24.1		16.1		12.1		9.5		ns
$t_{PZL}^{(1)}$			33.1		18.5		14.1		10.8		
$t_{PZH}^{(1)}$	DIR	B	22		14.2		12.1		10.5		ns
$t_{PZL}^{(1)}$			20.4		14.1		12.4		11.3		

(1) The enable time is a calculated value, derived using the formula shown in the [Enable Times](#) section.

6.10 Operating Characteristics

 $T_A = 25^\circ\text{C}$

PARAMETER		TEST CONDITIONS	$V_{CCA} =$ $V_{CCB} = 1.8\text{ V}$	$V_{CCA} =$ $V_{CCB} = 2.5\text{ V}$	$V_{CCA} =$ $V_{CCB} = 3.3\text{ V}$	$V_{CCA} =$ $V_{CCB} = 5\text{ V}$	UNIT
			TYP	TYP	TYP	TYP	
C_{pdA} ⁽¹⁾	A-port input, B-port output	$C_L = 0\text{ pF}$, $f = 10\text{ MHz}$, $t_r = t_f = 1\text{ ns}$	3	4	4	4	pF
	B-port input, A-port output		18	19	20	21	
C_{pdB} ⁽¹⁾	A-port input, B-port output	$C_L = 0\text{ pF}$, $f = 10\text{ MHz}$, $t_r = t_f = 1\text{ ns}$	18	19	20	21	pF
	B-port input, A-port output		3	4	4	4	

(1) Power dissipation capacitance per transceiver.

6.11 Typical Characteristics

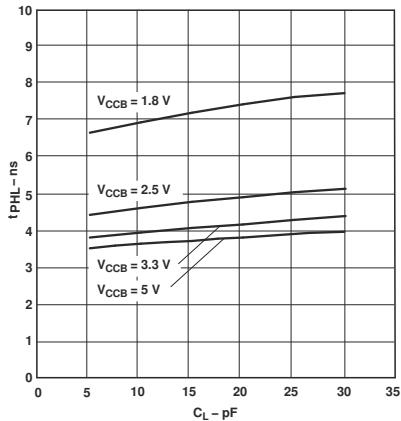

Figure 6-1. Typical Propagation Delay of High-to-Low (A to B) vs Load Capacitance $T_A = 25^\circ\text{C}$, $V_{CCA} = 1.8\text{ V}$

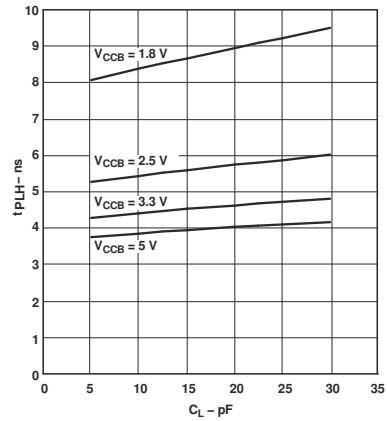

Figure 6-2. Typical Propagation Delay of Low-to-High (A to B) vs Load Capacitance $T_A = 25^\circ\text{C}$, $V_{CCA} = 1.8\text{ V}$

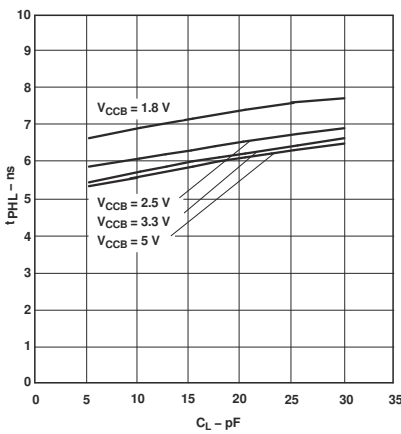

Figure 6-3. Typical Propagation Delay of High-to-Low (B to A) vs Load Capacitance $T_A = 25^\circ\text{C}$, $V_{CCA} = 1.8\text{ V}$

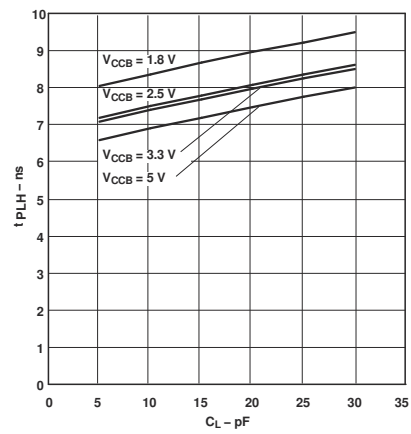

Figure 6-4. Typical Propagation Delay of Low-to-High (B to A) vs Load Capacitance $T_A = 25^\circ\text{C}$, $V_{CCA} = 1.8\text{ V}$

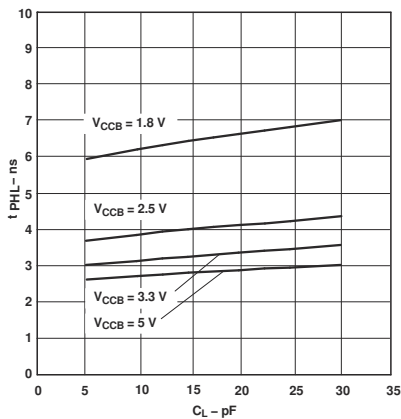

Figure 6-5. Typical Propagation Delay of High-to-Low (A to B) vs Load Capacitance $T_A = 25^\circ\text{C}$, $V_{CCA} = 2.5\text{ V}$

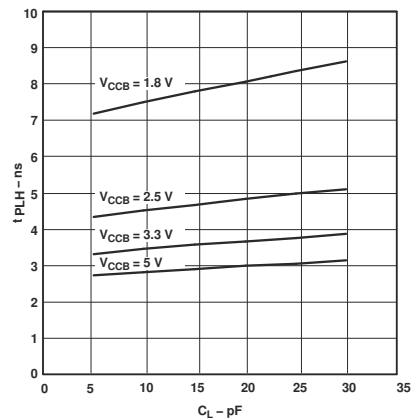

Figure 6-6. Typical Propagation Delay of Low-to-High (A to B) vs Load Capacitance $T_A = 25^\circ\text{C}$, $V_{CCA} = 2.5\text{ V}$

6.11 Typical Characteristics (continued)

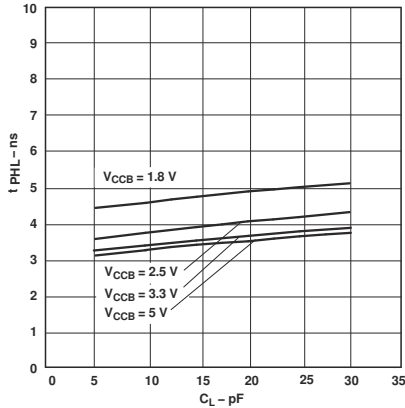

Figure 6-7. Typical Propagation Delay of High-to-Low (B to A) vs Load Capacitance $T_A = 25^\circ\text{C}$, $V_{CCA} = 2.5\text{ V}$

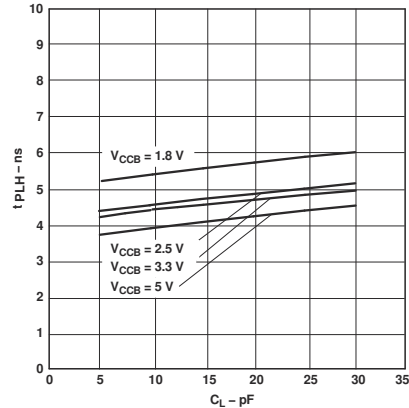

Figure 6-8. Typical Propagation Delay of Low-to-High (B to A) vs Load Capacitance $T_A = 25^\circ\text{C}$, $V_{CCA} = 2.5\text{ V}$

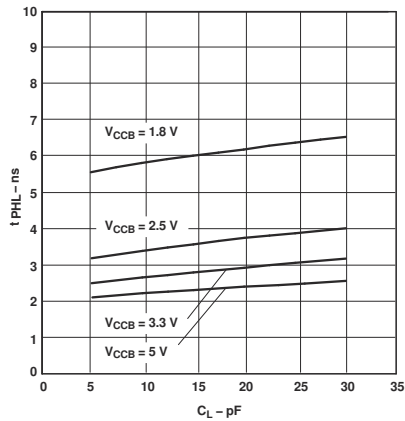

Figure 6-9. Typical Propagation Delay of High-to-Low (A to B) vs Load Capacitance $T_A = 25^\circ\text{C}$, $V_{CCA} = 3.3\text{ V}$

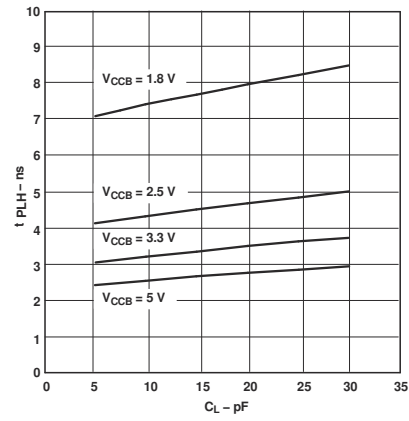

Figure 6-10. Typical Propagation Delay of Low-to-High (A to B) vs Load Capacitance $T_A = 25^\circ\text{C}$, $V_{CCA} = 3.3\text{ V}$

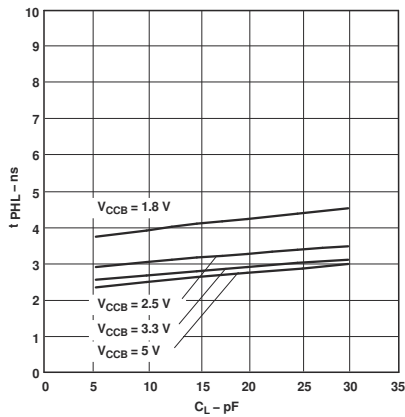

Figure 6-11. Typical Propagation Delay of High-to-Low (B to A) vs Load Capacitance $T_A = 25^\circ\text{C}$, $V_{CCA} = 3.3\text{ V}$

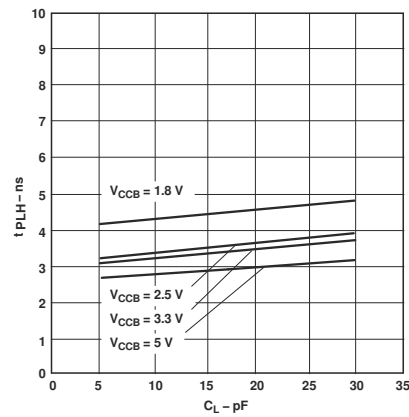

Figure 6-12. Typical Propagation Delay of Low-to-High (B to A) vs Load Capacitance $T_A = 25^\circ\text{C}$, $V_{CCA} = 3.3\text{ V}$

6.11 Typical Characteristics (continued)

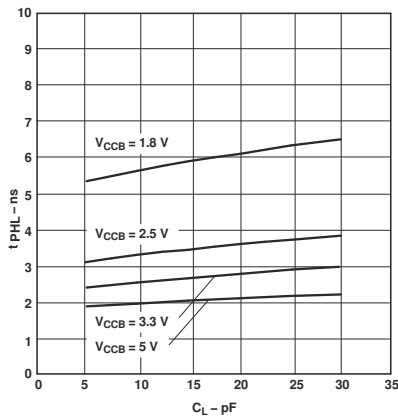

Figure 6-13. Typical Propagation Delay of High-to-Low (A to B) vs Load Capacitance $T_A = 25^\circ\text{C}$, $V_{CCA} = 5\text{ V}$

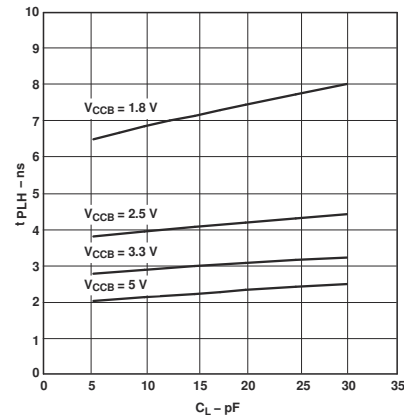

Figure 6-14. Typical Propagation Delay of Low-to-High (A to B) vs Load Capacitance $T_A = 25^\circ\text{C}$, $V_{CCA} = 5\text{ V}$

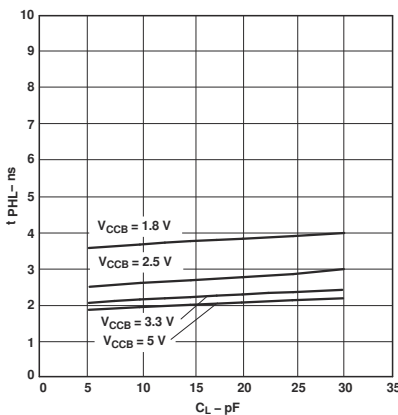

Figure 6-15. Typical Propagation Delay of High-to-Low (B to A) vs Load Capacitance $T_A = 25^\circ\text{C}$, $V_{CCA} = 5\text{ V}$

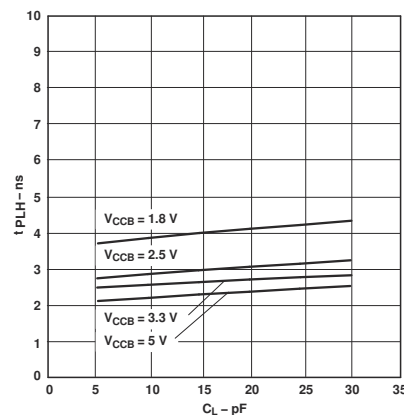
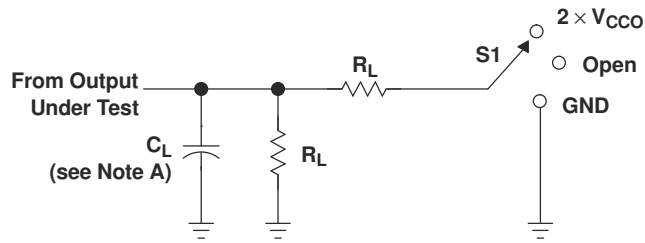

Figure 6-16. Typical Propagation Delay of Low-to-High (B to A) vs Load Capacitance $T_A = 25^\circ\text{C}$, $V_{CCA} = 5\text{ V}$

7 Parameter Measurement Information



LOAD CIRCUIT

V_{CCO}	C_L	R_L	V_{TP}
$1.8\text{ V} \pm 0.15\text{ V}$	15 pF	2 k Ω	0.15 V
$2.5\text{ V} \pm 0.2\text{ V}$	15 pF	2 k Ω	0.15 V
$3.3\text{ V} \pm 0.3\text{ V}$	15 pF	2 k Ω	0.3 V
$5\text{ V} \pm 0.5\text{ V}$	15 pF	2 k Ω	0.3 V

TEST	S1
t_{pd}	Open
t_{PLZ}/t_{PZL}	$2 \times V_{CCO}$
t_{PHZ}/t_{PZH}	GND

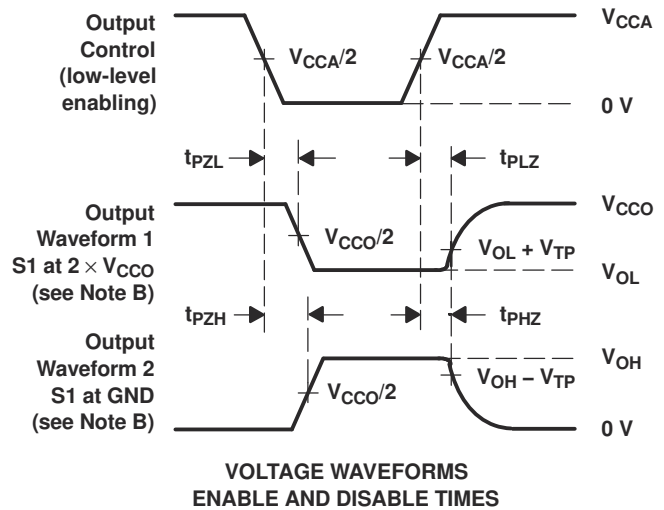
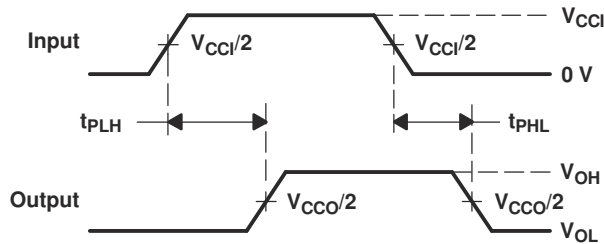
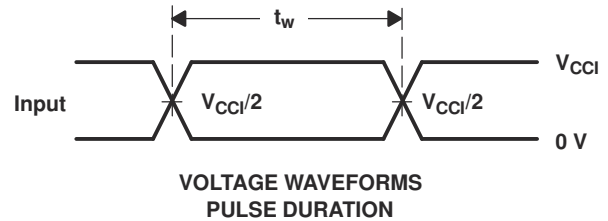

- NOTES: A. C_L includes probe and jig capacitance.
 B. Waveform 1 is for an output with internal conditions such that the output is low, except when disabled by the output control. Waveform 2 is for an output with internal conditions such that the output is high, except when disabled by the output control.
 C. All input pulses are supplied by generators having the following characteristics: $PRR \leq 10\text{ MHz}$, $Z_O = 50\ \Omega$, $dv/dt \geq 1\text{ V/ns}$.
 D. The outputs are measured one at a time, with one transition per measurement.
 E. t_{PLZ} and t_{PHZ} are the same as t_{dis} .
 F. t_{PZL} and t_{PZH} are the same as t_{en} .
 G. t_{PLH} and t_{PHL} are the same as t_{pd} .
 H. V_{CCI} is the V_{CC} associated with the input port.
 I. V_{CCO} is the V_{CC} associated with the output port.
 J. All parameters and waveforms are not applicable to all devices.

Figure 7-1. Load Circuit and Voltage Waveforms

8 Detailed Description

8.1 Overview

The SN74LVC2T45 is a dual-bit, dual-supply noninverting voltage level translation device. V_{CCA} supports pin Ax and the direction control pin, and V_{CCB} supports pin Bx. The A port is able to accept I/O voltages ranging from 1.65 V to 5.5 V, while the B port can accept I/O voltages from 1.65 V to 5.5 V. The high on DIR allows data transmission from A to B and a low on DIR allows data transmission from B to A.

8.2 Functional Block Diagram

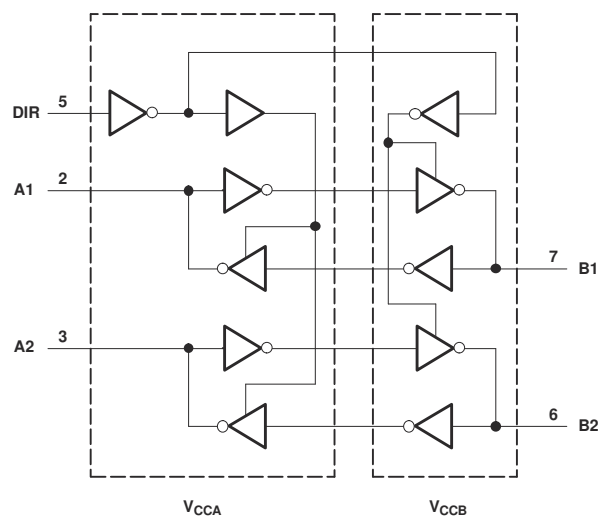

Figure 8-1. Logic Diagram (Positive Logic)

8.3 Feature Description

8.3.1 Fully Configurable Dual-Rail Design Allows Each Port to Operate Over the Full 1.65-V to 5.5-V Power-Supply Range

Both V_{CCA} and V_{CCB} can be supplied at any voltage between 1.65 V and 5.5 V making the device suitable for translating between any of the voltage nodes (1.8-V, 2.5-V, 3.3-V, and 5-V).

8.3.2 Support High-Speed Translation

SN74LVC2T45 can support high data rate applications. The translated signal data rate can be up to 420 Mbps when signal is translated from 3.3 V to 5 V.

8.3.3 I_{off} Supports Partial-Power-Down Mode Operation

I_{off} will prevent backflow current by disabling I/O output circuits when the device is in Partial-Power-Down mode. The inputs and outputs for this device enter a high-impedance state when the device is powered down, inhibiting current backflow into the device. The maximum leakage into or out of any input or output pin on the device is specified by I_{off} in the *Electrical Characteristics*.

8.3.4 Balanced High-Drive CMOS Push-Pull Outputs

A balanced output allows the device to sink and source similar currents. The high drive capability of this device creates fast edges into light loads so impedance matching and load conditions should be considered to prevent ringing. Additionally, the outputs of this device are capable of driving larger currents than the device can sustain without being damaged. Two outputs can be connected together for a stronger output drive strength. The electrical and thermal limits defined in the [Absolute Maximum Ratings](#) must be followed at all times.

8.3.5 V_{CC} Isolation

The I/O's of both ports will enter a high-impedance state when either of the supplies are at GND, while the other supply is still connected to the device. The maximum leakage into or out of any input or output pin on the device is specified by I_{off} in the *Electrical Characteristics*.

8.4 Device Functional Modes

Table 8-1 lists the functional modes of the SN74LVC2T45 device.

Table 8-1. Function Table (Each Transceiver)⁽¹⁾

INPUT DIR	OPERATION
L	B data to A bus
H	A data to B bus

(1) Input circuits of the data I/Os always are active.

9 Application and Implementation

Note

Information in the following applications sections is not part of the TI component specification, and TI does not warrant its accuracy or completeness. TI's customers are responsible for determining suitability of components for their purposes, as well as validating and testing their design implementation to confirm system functionality.

9.1 Application Information

The SN74LVC2T45 device can be used in level-translation applications for interfacing devices or systems operating at different interface voltages with one another. The maximum data rate can be up to 420 Mbps when the device translates signal from 3.3 V to 5 V. It is recommended to tie all unused I/Os to GND. The device should not have any floating I/Os when changing translation direction.

9.2 Typical Applications

9.2.1 Unidirectional Logic Level-Shifting Application

Figure 9-1 shows an example of the SN74LVC2T45 being used in a unidirectional logic level-shifting application.

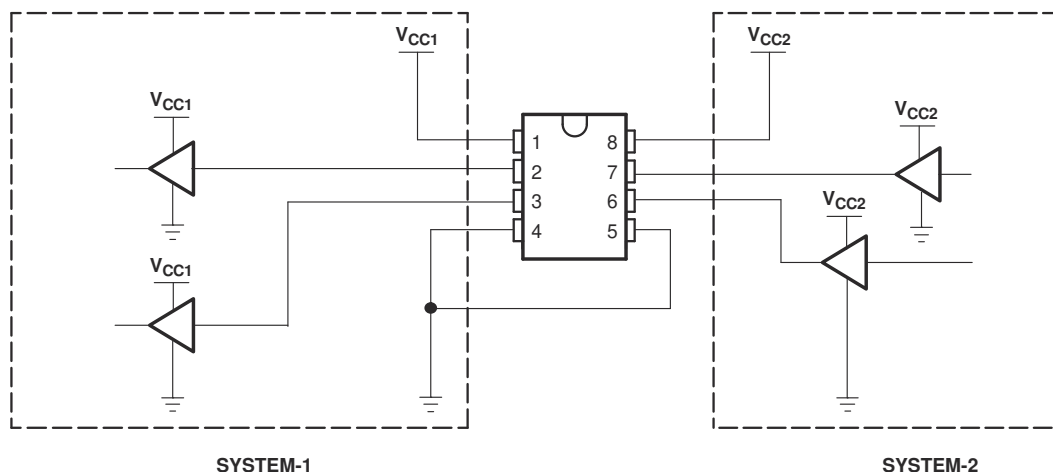

Figure 9-1. Unidirectional Logic Level-Shifting Application

9.2.1.1 Design Requirements

Table 9-1 lists the pins and pin descriptions of the SN74LVC2T45 connections with SYSTEM-1 and SYSTEM-2.

Table 9-1. SN74LVC2T45 Pin Connections With SYSTEM-1 and SYSTEM-2

PIN	NAME	FUNCTION	DESCRIPTION
1	V _{CCA}	V _{CC1}	SYSTEM-1 supply voltage (1.65 V to 5.5 V)
2	A1	OUT1	Output level depends on V _{CC1} voltage.
3	A2	OUT2	Output level depends on V _{CC1} voltage.
4	GND	GND	Device GND
5	DIR	DIR	GND (low level) determines B-port to A-port direction.
6	B2	IN2	Input threshold value depends on V _{CC2} voltage.
7	B1	IN1	Input threshold value depends on V _{CC2} voltage.
8	V _{CCB}	V _{CC2}	SYSTEM-2 supply voltage (1.65 V to 5.5 V)

For this design example, use the parameters listed in Table 9-2.

Table 9-2. Design Parameters

DESIGN PARAMETER	EXAMPLE VALUE
Input voltage range	1.65 V to 5.5 V
Output voltage range	1.65 V to 5.5 V

9.2.1.2 Detailed Design Procedure

To begin the design process, determine the following:

- Input voltage range
 - Use the supply voltage of the device that is driving the SN74LVC2T45 device to determine the input voltage range. For a valid logic high, the value must exceed the V_{IH} of the input port. For a valid logic low, the value must be less than the V_{IL} of the input port.
- Output voltage range
 - Use the supply voltage of the device that the SN74LVC2T45 device is driving to determine the output voltage range.

9.2.1.3 Application Curve

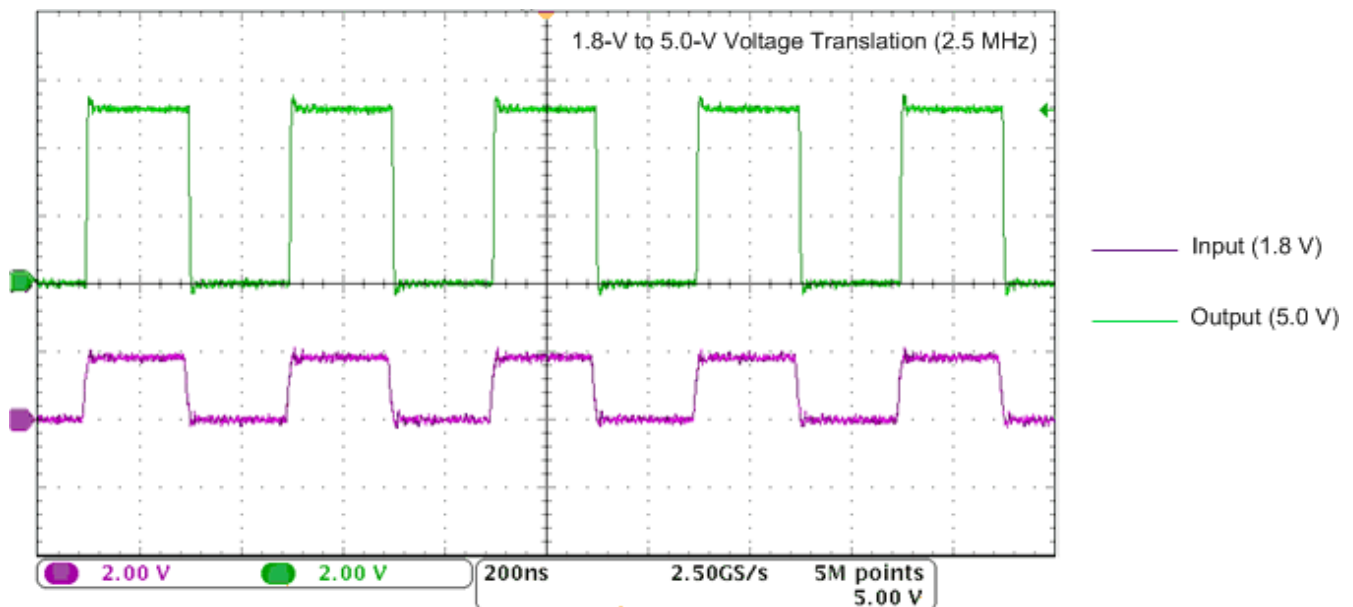

9.2.2 Bidirectional Logic Level-Shifting Application

Figure 9-2 shows the SN74LVC2T45 being used in a bidirectional logic level-shifting application. Because the SN74LVC2T45 does not have an output-enable (OE) pin, the system designer should take precautions to avoid bus contention between SYSTEM-1 and SYSTEM-2 when changing directions.

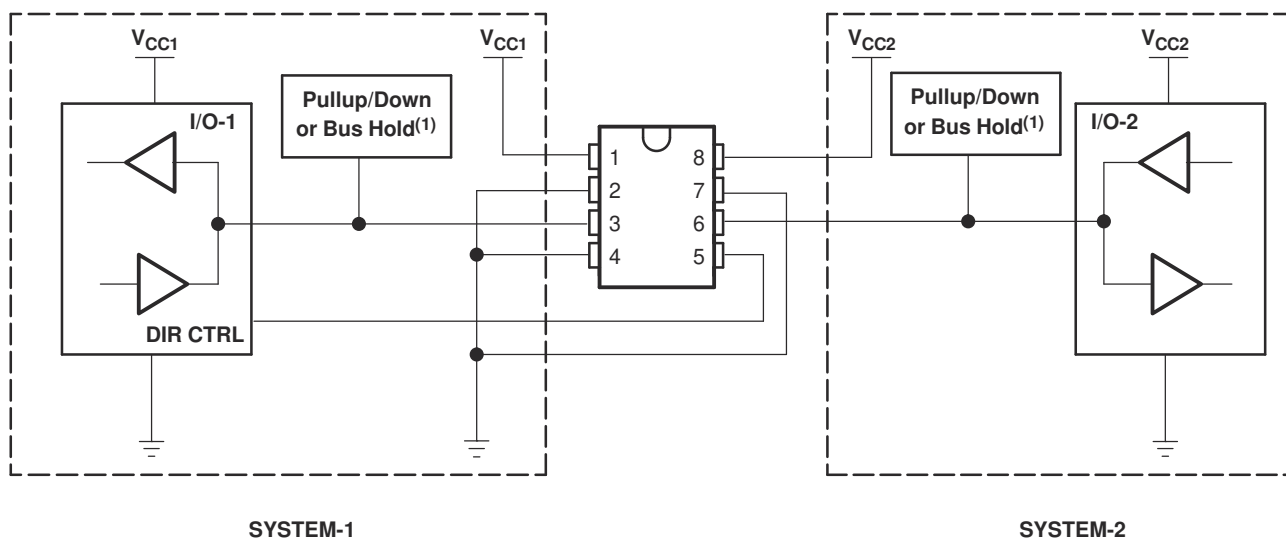

Figure 9-2. Bidirectional Logic Level-Shifting Application

9.2.2.1 Design Requirements

Refer to [Section 9.2.1](#).

9.2.2.2 Detailed Design Procedure

[Table 9-3](#) provides data transmission from SYSTEM-1 to SYSTEM-2 and then from SYSTEM-2 to SYSTEM-1.

Table 9-3. Data Transmission Sequence

STATE	DIR CTRL	I/O-1	I/O-2	DESCRIPTION
1	H	Out	In	SYSTEM-1 data to SYSTEM-2
2	H	Hi-Z	Hi-Z	SYSTEM-2 is getting ready to send data to SYSTEM-1. I/O-1 and I/O-2 are disabled. The bus-line state depends on pullup or pulldown. ⁽¹⁾
3	L	Hi-Z	Hi-Z	DIR bit is flipped. I/O-1 and I/O-2 still are disabled. The bus-line state depends on pullup or pulldown. ⁽¹⁾
4	L	In	Out	SYSTEM-2 data to SYSTEM-1

(1) SYSTEM-1 and SYSTEM-2 must use the same conditions, that is, both pullup or both pulldown.

9.2.2.2.1 Enable Times

Calculate the enable times for the SN74LVC2T45 using the following formulas:

- $t_{pZH}(\text{DIR to A}) = t_{pLZ}(\text{DIR to B}) + t_{pLH}(\text{B to A})$
- $t_{pZL}(\text{DIR to A}) = t_{pHZ}(\text{DIR to B}) + t_{pHL}(\text{B to A})$
- $t_{pZH}(\text{DIR to B}) = t_{pLZ}(\text{DIR to A}) + t_{pLH}(\text{A to B})$
- $t_{pZL}(\text{DIR to B}) = t_{pHZ}(\text{DIR to A}) + t_{pHL}(\text{A to B})$

In a bidirectional application, these enable times provide the maximum delay from the time the DIR bit is switched until an output is expected. For example, if the SN74LVC2T45 initially is transmitting from A to B, then the DIR bit is switched; the B port of the device must be disabled before presenting it with an input. After the B port has been disabled, an input signal applied to it appears on the corresponding A port after the specified propagation delay.

9.2.2.3 Application Curve

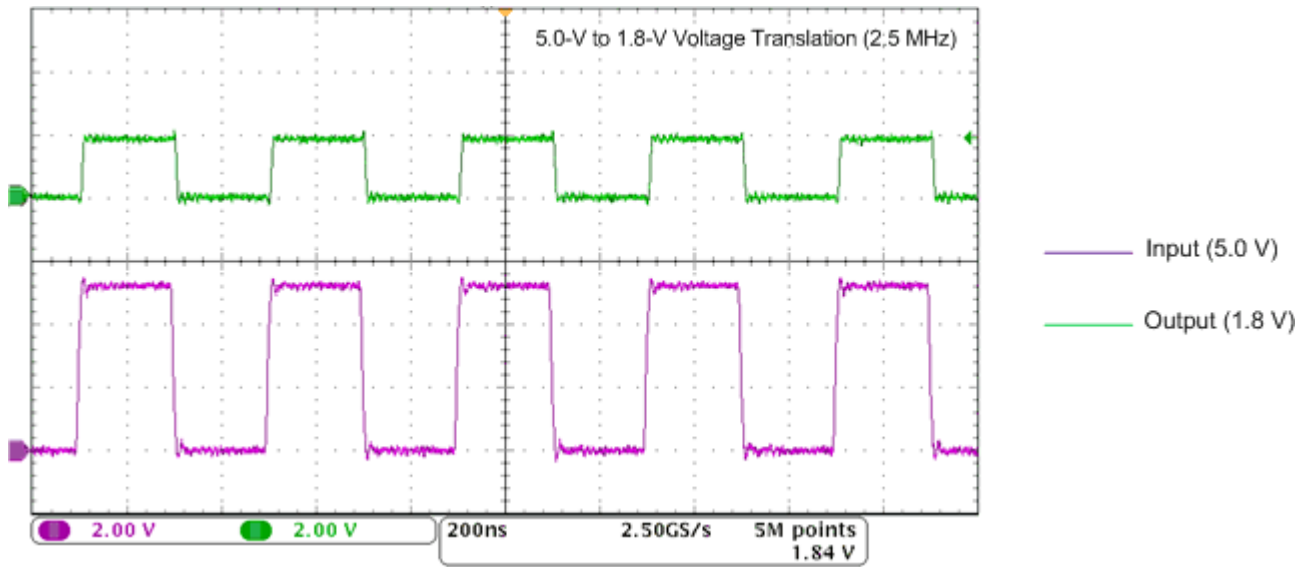

10 Power Supply Recommendations

10.1 Power-Up Considerations

A proper power-up sequence with inputs held at ground should be followed as listed:

1. Connect ground before any supply voltage is applied.
2. Power up V_{CCA} .
3. V_{CCB} can be ramped up along with or after V_{CCA} .

The power supply can be any voltage between the minimum and maximum supply voltage rating located in the [Recommended Operating Conditions](#). The recommendation is to first power-up the input supply rail to help avoid internal floating while the output supply rail ramps up. However, both power-supply rails can be ramped up simultaneously.

Each V_{CC} pin must have a good bypass capacitor to prevent power disturbance. For devices with a single supply, 0.1 μF is recommended. If there are multiple V_{CC} pins, 0.01 μF or 0.022 μF is recommended for each power pin. It is acceptable to parallel multiple bypass capacitors to reject different frequencies of noise. 0.1- μF and 1- μF capacitors are commonly used in parallel. The bypass capacitor must be installed as close to the power pin as possible for best results.

Table 10-1. Typical Total Static Power Consumption ($I_{CCA} + I_{CCB}$)

V_{CCB}	V_{CCA}					UNIT
	0 V	1.8 V	2.5 V	3.3 V	5 V	
0 V	0	< 1	< 1	< 1	< 1	μA
1.8 V	< 1	< 2	< 2	< 2	2	
2.5 V	< 1	< 2	< 2	< 2	< 2	
3.3 V	< 1	< 2	< 2	< 2	< 2	
5 V	< 1	2	< 2	< 2	< 2	

11 Layout

11.1 Layout Guidelines

It is recommended to follow common printed-circuit board layout guidelines to ensure reliability of the device, such as the following:

- Use bypass capacitors on the power supplies.
- Use short trace lengths to avoid excessive loading.
- Place pads on the signal paths for loading capacitors or pullup resistors to help adjust rise and fall times of signals depending on the system requirements.

11.2 Layout Example

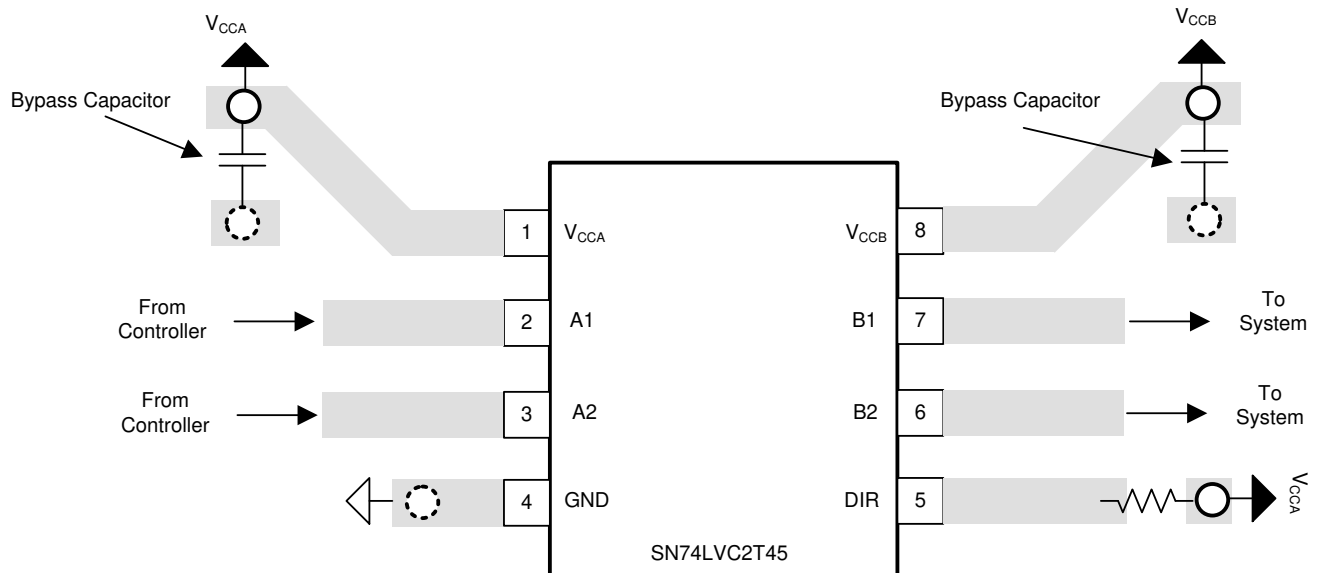
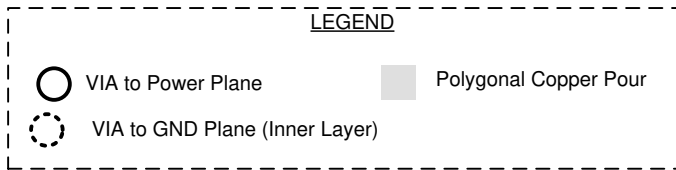

Figure 11-1. SN74LVC2T45 Layout Example

12 Device and Documentation Support

12.1 Documentation Support

12.1.1 Related Documentation

For related documentation, see the following:

- Texas Instruments, [Implications of Slow or Floating CMOS Inputs application note](#)
- Texas Instruments, [Designing with SN74LVCXT245 and SN74LVCHXT245 Family of Direction controlled voltage translators application note](#)

12.2 Receiving Notification of Documentation Updates

To receive notification of documentation updates, navigate to the device product folder on ti.com. Click on *Subscribe to updates* to register and receive a weekly digest of any product information that has changed. For change details, review the revision history included in any revised document.

12.3 Support Resources

TI E2E™ [support forums](#) are an engineer's go-to source for fast, verified answers and design help — straight from the experts. Search existing answers or ask your own question to get the quick design help you need.

Linked content is provided "AS IS" by the respective contributors. They do not constitute TI specifications and do not necessarily reflect TI's views; see TI's [Terms of Use](#).

12.4 Trademarks

NanoFree™ is a trademark of Texas Instruments.

TI E2E™ is a trademark of Texas Instruments.

All trademarks are the property of their respective owners.

12.5 Electrostatic Discharge Caution



This integrated circuit can be damaged by ESD. Texas Instruments recommends that all integrated circuits be handled with appropriate precautions. Failure to observe proper handling and installation procedures can cause damage.

ESD damage can range from subtle performance degradation to complete device failure. Precision integrated circuits may be more susceptible to damage because very small parametric changes could cause the device not to meet its published specifications.

12.6 Glossary

[TI Glossary](#) This glossary lists and explains terms, acronyms, and definitions.

13 Mechanical, Packaging, and Orderable Information

The following pages include mechanical, packaging, and orderable information. This information is the most current data available for the designated devices. This data is subject to change without notice and revision of this document. For browser-based versions of this data sheet, refer to the left-hand navigation.

PACKAGING INFORMATION

Orderable Device	Status (1)	Package Type	Package Drawing	Pins	Package Qty	Eco Plan (2)	Lead finish/ Ball material (6)	MSL Peak Temp (3)	Op Temp (°C)	Device Marking (4/5)	Samples
SN74LVC2T45DCTR	ACTIVE	SM8	DCT	8	3000	RoHS & Green	SN	Level-1-260C-UNLIM	-40 to 85	CT2 (R, Z)	Samples
SN74LVC2T45DCTRE4	ACTIVE	SM8	DCT	8	3000	RoHS & Green	SN	Level-1-260C-UNLIM	-40 to 85	CT2 (R, Z)	Samples
SN74LVC2T45DCTT	ACTIVE	SM8	DCT	8	250	RoHS & Green	SN	Level-1-260C-UNLIM	-40 to 85	CT2 (R, Z)	Samples
SN74LVC2T45DCTTG4	ACTIVE	SM8	DCT	8	250	RoHS & Green	SN	Level-1-260C-UNLIM	-40 to 85	CT2 (R, Z)	Samples
SN74LVC2T45DCUR	ACTIVE	VSSOP	DCU	8	3000	RoHS & Green	SN	Level-1-260C-UNLIM	-40 to 85	(CT2J, CT2Q, CT2R, T2) CZ	Samples
SN74LVC2T45DCURE4	ACTIVE	VSSOP	DCU	8	3000	RoHS & Green	NIPDAU	Level-1-260C-UNLIM	-40 to 85	CT2R	Samples
SN74LVC2T45DCURG4	ACTIVE	VSSOP	DCU	8	3000	RoHS & Green	NIPDAU	Level-1-260C-UNLIM	-40 to 85	CT2R	Samples
SN74LVC2T45DCUT	ACTIVE	VSSOP	DCU	8	250	RoHS & Green	SN	Level-1-260C-UNLIM	-40 to 85	(CT2J, CT2Q, CT2R, T2) CZ	Samples
SN74LVC2T45DCUTG4	ACTIVE	VSSOP	DCU	8	250	RoHS & Green	NIPDAU	Level-1-260C-UNLIM	-40 to 85	CT2R	Samples
SN74LVC2T45YZPR	ACTIVE	DSBGA	YZP	8	3000	RoHS & Green	SAC396 SNAGCU	Level-1-260C-UNLIM	-40 to 85	(TB, TB7, TBN)	Samples

(1) The marketing status values are defined as follows:

ACTIVE: Product device recommended for new designs.

LIFEBUY: TI has announced that the device will be discontinued, and a lifetime-buy period is in effect.

NRND: Not recommended for new designs. Device is in production to support existing customers, but TI does not recommend using this part in a new design.

PREVIEW: Device has been announced but is not in production. Samples may or may not be available.

OBSOLETE: TI has discontinued the production of the device.

(2) **RoHS:** TI defines "RoHS" to mean semiconductor products that are compliant with the current EU RoHS requirements for all 10 RoHS substances, including the requirement that RoHS substance do not exceed 0.1% by weight in homogeneous materials. Where designed to be soldered at high temperatures, "RoHS" products are suitable for use in specified lead-free processes. TI may reference these types of products as "Pb-Free".

RoHS Exempt: TI defines "RoHS Exempt" to mean products that contain lead but are compliant with EU RoHS pursuant to a specific EU RoHS exemption.

Green: TI defines "Green" to mean the content of Chlorine (Cl) and Bromine (Br) based flame retardants meet JS709B low halogen requirements of <=1000ppm threshold. Antimony trioxide based flame retardants must also meet the <=1000ppm threshold requirement.

- (3) MSL, Peak Temp. - The Moisture Sensitivity Level rating according to the JEDEC industry standard classifications, and peak solder temperature.
- (4) There may be additional marking, which relates to the logo, the lot trace code information, or the environmental category on the device.
- (5) Multiple Device Markings will be inside parentheses. Only one Device Marking contained in parentheses and separated by a "~" will appear on a device. If a line is indented then it is a continuation of the previous line and the two combined represent the entire Device Marking for that device.
- (6) Lead finish/Ball material - Orderable Devices may have multiple material finish options. Finish options are separated by a vertical ruled line. Lead finish/Ball material values may wrap to two lines if the finish value exceeds the maximum column width.

Important Information and Disclaimer:The information provided on this page represents TI's knowledge and belief as of the date that it is provided. TI bases its knowledge and belief on information provided by third parties, and makes no representation or warranty as to the accuracy of such information. Efforts are underway to better integrate information from third parties. TI has taken and continues to take reasonable steps to provide representative and accurate information but may not have conducted destructive testing or chemical analysis on incoming materials and chemicals. TI and TI suppliers consider certain information to be proprietary, and thus CAS numbers and other limited information may not be available for release.

In no event shall TI's liability arising out of such information exceed the total purchase price of the TI part(s) at issue in this document sold by TI to Customer on an annual basis.

OTHER QUALIFIED VERSIONS OF SN74LVC2T45 :

- Automotive : [SN74LVC2T45-Q1](#)
- Enhanced Product : [SN74LVC2T45-EP](#)

NOTE: Qualified Version Definitions:

- Automotive - Q100 devices qualified for high-reliability automotive applications targeting zero defects
- Enhanced Product - Supports Defense, Aerospace and Medical Applications

TAPE AND REEL INFORMATION

QUADRANT ASSIGNMENTS FOR PIN 1 ORIENTATION IN TAPE

*All dimensions are nominal

Device	Package Type	Package Drawing	Pins	SPQ	Reel Diameter (mm)	Reel Width W1 (mm)	A0 (mm)	B0 (mm)	K0 (mm)	P1 (mm)	W (mm)	Pin1 Quadrant
SN74LVC2T45DCTR	SM8	DCT	8	3000	180.0	12.4	3.15	4.35	1.55	4.0	12.0	Q3
SN74LVC2T45DCTT	SM8	DCT	8	250	180.0	12.4	3.15	4.35	1.55	4.0	12.0	Q3
SN74LVC2T45DCUR	VSSOP	DCU	8	3000	178.0	9.0	2.25	3.35	1.05	4.0	8.0	Q3
SN74LVC2T45DCURG4	VSSOP	DCU	8	3000	178.0	9.0	2.25	3.35	1.05	4.0	8.0	Q3
SN74LVC2T45DCUT	VSSOP	DCU	8	250	178.0	9.0	2.25	3.35	1.05	4.0	8.0	Q3
SN74LVC2T45DCUTG4	VSSOP	DCU	8	250	180.0	8.4	2.25	3.35	1.05	4.0	8.0	Q3
SN74LVC2T45YZPR	DSBGA	YZP	8	3000	180.0	8.4	1.02	2.02	0.63	4.0	8.0	Q1

TAPE AND REEL BOX DIMENSIONS



*All dimensions are nominal

Device	Package Type	Package Drawing	Pins	SPQ	Length (mm)	Width (mm)	Height (mm)
SN74LVC2T45DCTR	SM8	DCT	8	3000	190.0	190.0	30.0
SN74LVC2T45DCTT	SM8	DCT	8	250	190.0	190.0	30.0
SN74LVC2T45DCUR	VSSOP	DCU	8	3000	180.0	180.0	18.0
SN74LVC2T45DCURG4	VSSOP	DCU	8	3000	180.0	180.0	18.0
SN74LVC2T45DCUT	VSSOP	DCU	8	250	180.0	180.0	18.0
SN74LVC2T45DCUTG4	VSSOP	DCU	8	250	202.0	201.0	28.0
SN74LVC2T45YZPR	DSBGA	YZP	8	3000	182.0	182.0	20.0

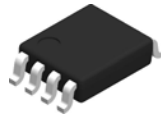

4225266/A 09/2014

NOTES:

1. All linear dimensions are in millimeters. Any dimensions in parenthesis are for reference only. Dimensioning and tolerancing per ASME Y14.5M.
2. This drawing is subject to change without notice.
3. This dimension does not include mold flash, protrusions, or gate burrs. Mold flash, protrusions, or gate burrs shall not exceed 0.15 mm per side.
4. Reference JEDEC registration MO-187 variation CA.

EXAMPLE BOARD LAYOUT

DCU0008A

VSSOP - 0.9 mm max height

SMALL OUTLINE PACKAGE

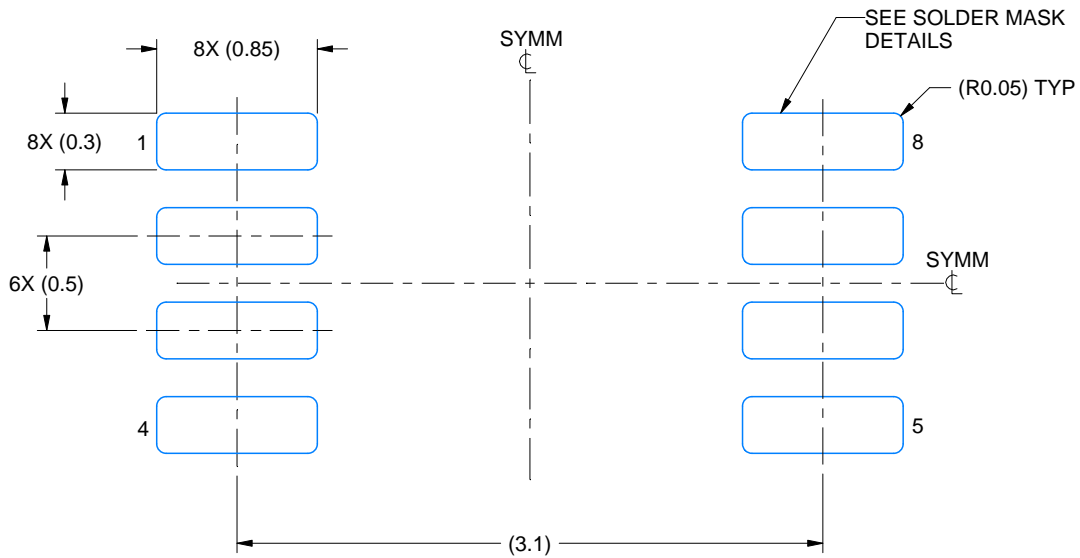

LAND PATTERN EXAMPLE
EXPOSED METAL SHOWN
SCALE: 25X

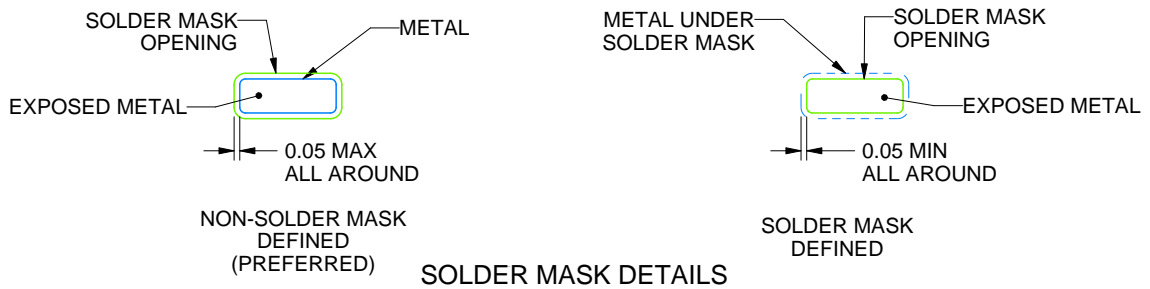

4225266/A 09/2014

NOTES: (continued)

- 5. Publication IPC-7351 may have alternate designs.
- 6. Solder mask tolerances between and around signal pads can vary based on board fabrication site.

EXAMPLE STENCIL DESIGN

DCU0008A

VSSOP - 0.9 mm max height

SMALL OUTLINE PACKAGE

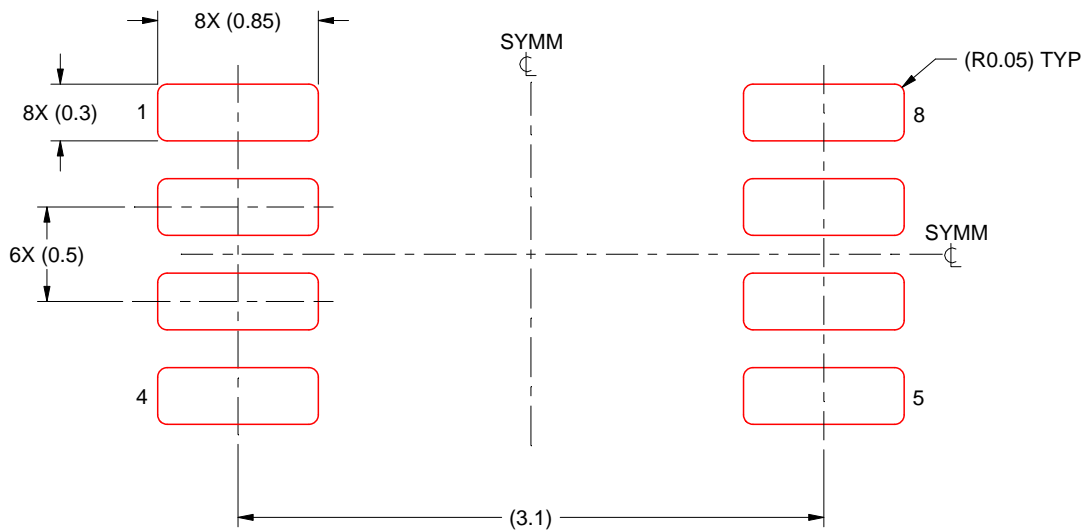

SOLDER PASTE EXAMPLE
BASED ON 0.125 mm THICK STENCIL
SCALE: 25X

4225266/A 09/2014

NOTES: (continued)

7. Laser cutting apertures with trapezoidal walls and rounded corners may offer better paste release. IPC-7525 may have alternate design recommendations.
8. Board assembly site may have different recommendations for stencil design.

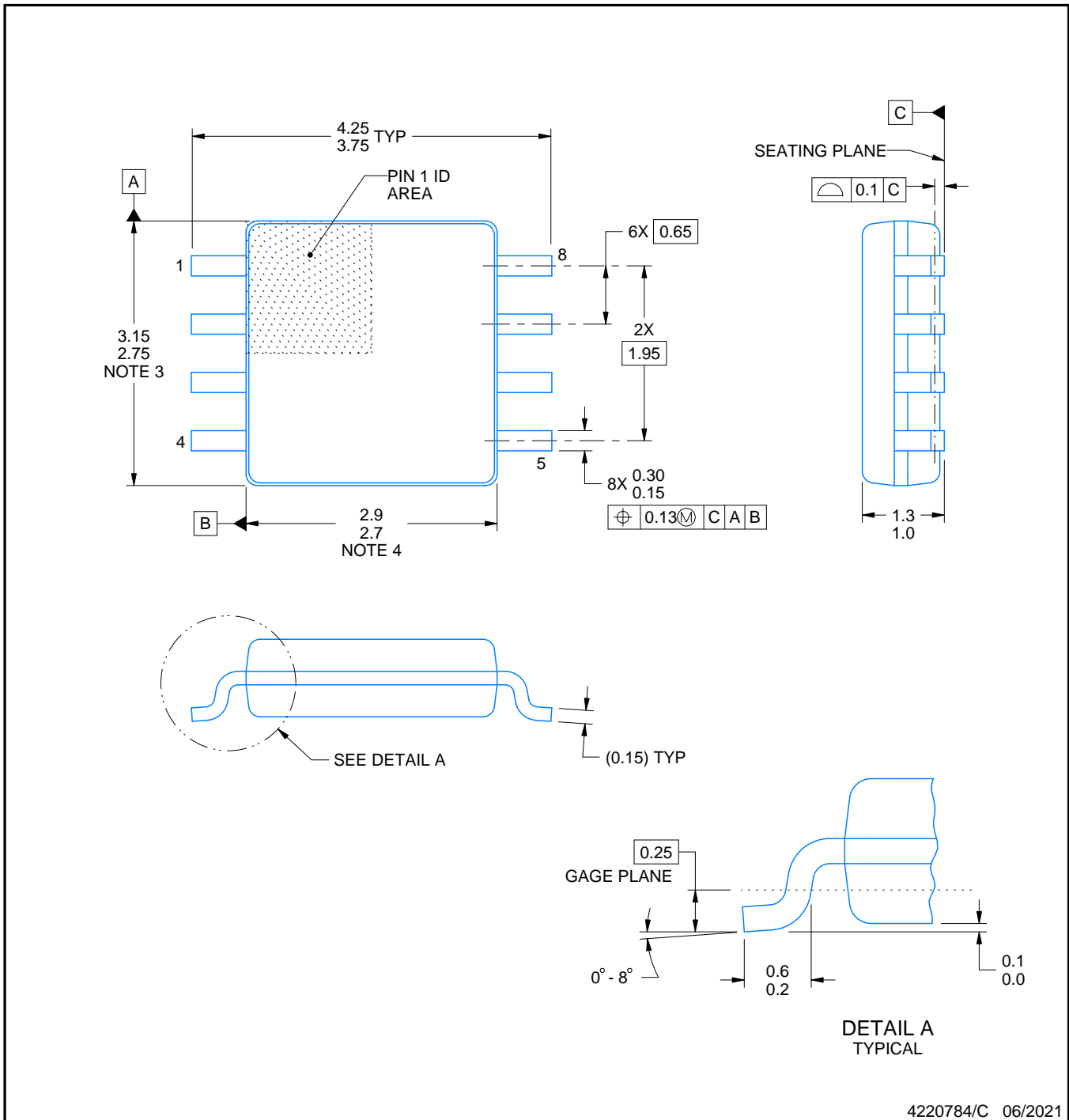
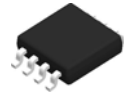

4220784/C 06/2021

NOTES:

1. All linear dimensions are in millimeters. Dimensions in parenthesis are for reference only. Dimensioning and tolerancing per ASME Y14.5M.
2. This drawing is subject to change without notice.
3. This dimension does not include mold flash, protrusions, or gate burrs. Mold flash, protrusions, or gate burrs shall not exceed 0.15 mm per side.
4. This dimension does not include interlead flash. Interlead flash shall not exceed 0.25 mm per side.

EXAMPLE BOARD LAYOUT

DCT0008A

SSOP - 1.3 mm max height

SMALL OUTLINE PACKAGE

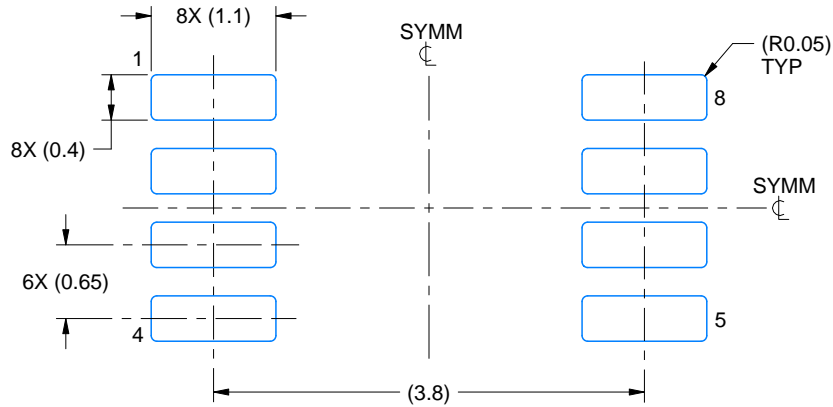

LAND PATTERN EXAMPLE
EXPOSED METAL SHOWN
SCALE:15X

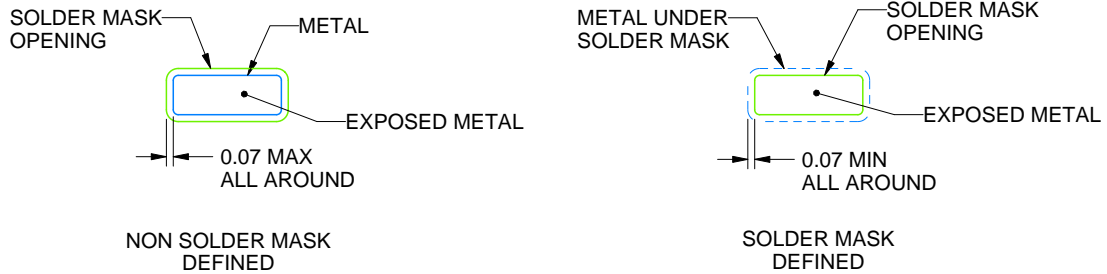

SOLDER MASK DETAILS

4220784/C 06/2021

NOTES: (continued)

5. Publication IPC-7351 may have alternate designs.
6. Solder mask tolerances between and around signal pads can vary based on board fabrication site.

EXAMPLE STENCIL DESIGN

DCT0008A

SSOP - 1.3 mm max height

SMALL OUTLINE PACKAGE

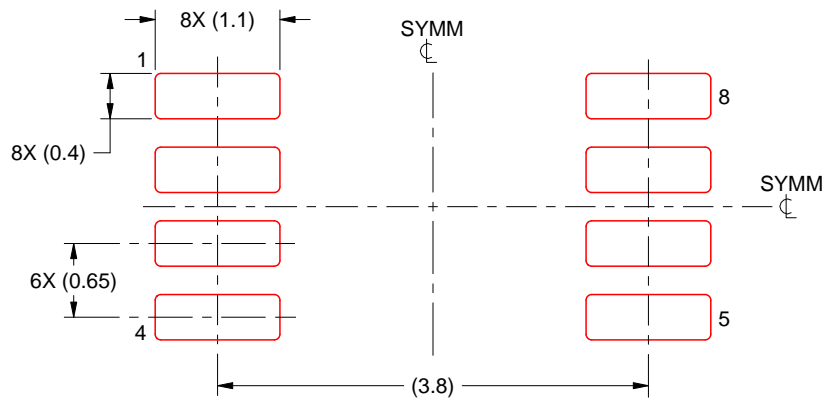

SOLDER PASTE EXAMPLE
BASED ON 0.125 mm THICK STENCIL
SCALE:15X

4220784/C 06/2021

NOTES: (continued)

7. Laser cutting apertures with trapezoidal walls and rounded corners may offer better paste release. IPC-7525 may have alternate design recommendations.
8. Board assembly site may have different recommendations for stencil design.

YZP0008

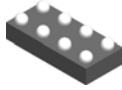

PACKAGE OUTLINE

DSBGA - 0.5 mm max height

DIE SIZE BALL GRID ARRAY

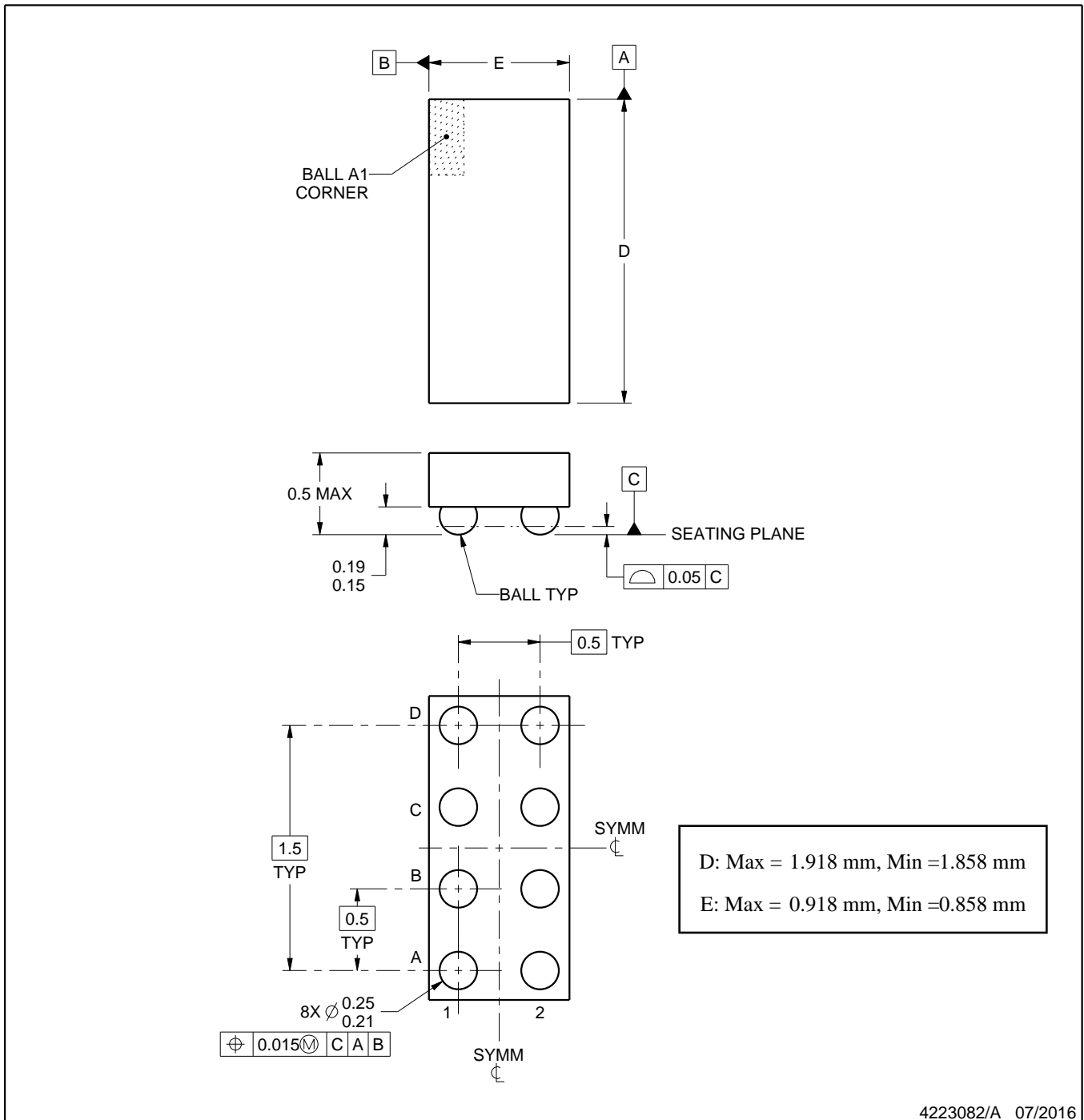

4223082/A 07/2016

NOTES:

1. All linear dimensions are in millimeters. Any dimensions in parenthesis are for reference only. Dimensioning and tolerancing per ASME Y14.5M.
2. This drawing is subject to change without notice.

EXAMPLE BOARD LAYOUT

YZP0008

DSBGA - 0.5 mm max height

DIE SIZE BALL GRID ARRAY

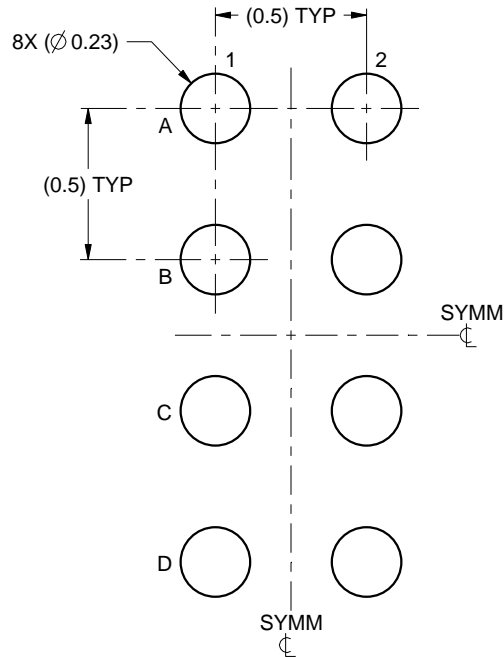

LAND PATTERN EXAMPLE
SCALE:40X

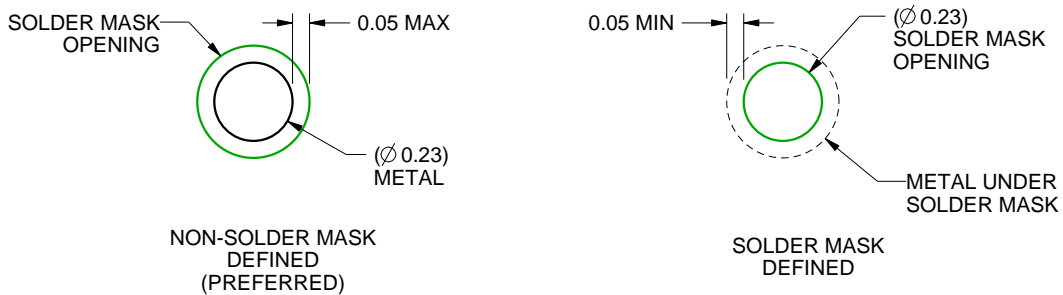

SOLDER MASK DETAILS
NOT TO SCALE

4223082/A 07/2016

NOTES: (continued)

3. Final dimensions may vary due to manufacturing tolerance considerations and also routing constraints. For more information, see Texas Instruments literature number SNVA009 (www.ti.com/lit/snva009).

EXAMPLE STENCIL DESIGN

YZP0008

DSBGA - 0.5 mm max height

DIE SIZE BALL GRID ARRAY

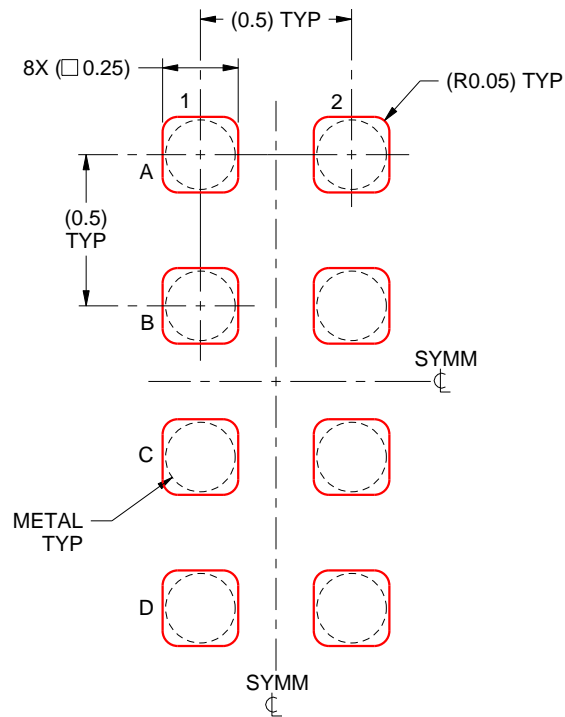

SOLDER PASTE EXAMPLE
BASED ON 0.1 mm THICK STENCIL
SCALE:40X

4223082/A 07/2016

NOTES: (continued)

4. Laser cutting apertures with trapezoidal walls and rounded corners may offer better paste release.

IMPORTANT NOTICE AND DISCLAIMER

TI PROVIDES TECHNICAL AND RELIABILITY DATA (INCLUDING DATA SHEETS), DESIGN RESOURCES (INCLUDING REFERENCE DESIGNS), APPLICATION OR OTHER DESIGN ADVICE, WEB TOOLS, SAFETY INFORMATION, AND OTHER RESOURCES "AS IS" AND WITH ALL FAULTS, AND DISCLAIMS ALL WARRANTIES, EXPRESS AND IMPLIED, INCLUDING WITHOUT LIMITATION ANY IMPLIED WARRANTIES OF MERCHANTABILITY, FITNESS FOR A PARTICULAR PURPOSE OR NON-INFRINGEMENT OF THIRD PARTY INTELLECTUAL PROPERTY RIGHTS.

These resources are intended for skilled developers designing with TI products. You are solely responsible for (1) selecting the appropriate TI products for your application, (2) designing, validating and testing your application, and (3) ensuring your application meets applicable standards, and any other safety, security, regulatory or other requirements.

These resources are subject to change without notice. TI grants you permission to use these resources only for development of an application that uses the TI products described in the resource. Other reproduction and display of these resources is prohibited. No license is granted to any other TI intellectual property right or to any third party intellectual property right. TI disclaims responsibility for, and you will fully indemnify TI and its representatives against, any claims, damages, costs, losses, and liabilities arising out of your use of these resources.

TI's products are provided subject to [TI's Terms of Sale](#) or other applicable terms available either on [ti.com](https://www.ti.com) or provided in conjunction with such TI products. TI's provision of these resources does not expand or otherwise alter TI's applicable warranties or warranty disclaimers for TI products.

TI objects to and rejects any additional or different terms you may have proposed.

Mailing Address: Texas Instruments, Post Office Box 655303, Dallas, Texas 75265
Copyright © 2024, Texas Instruments Incorporated

Looking for pricing, stock, or lifecycle information?

Click below to explore more details on WIN SOURCE:

 [View SN74LVC2T45DCTTG4 on WIN SOURCE](#)

 [Texas Instruments](#) Information

Optimize Your Supply Chain with WIN SOURCE Solutions

-  Global Sourcing Solution
-  Obsolete Management
-  Cost Control Management
-  Shortage Management
-  Alternative Solution
-  Excess Inventory Management