



**THE DATASHEET OF
SN65CML100EVM**





1.5-Gbps LVDS/LVPECL/CML-TO-CML TRANSLATOR/REPEATER

FEATURES

- Provides Level Translation From LVDS or LVPECL to CML, Repeating From CML to CML
- Signaling Rates⁽¹⁾ up to 1.5 Gbps
- CML Compatible Output Directly Drives Devices With 3.3-V, 2.5-V, or 1.8-V Supplies
- Total Jitter < 70 ps
- Low 100 ps (Max) Part-To-Part Skew
- Wide Common-Mode Receiver Capability Allows Direct Coupling of Input Signals
- 25 mV of Receiver Input Threshold Hysteresis Over 0-V to 4-V Common-Mode Range
- Propagation Delay Times, 800 ps Maximum
- 3.3-V Supply Operation
- Available in SOIC and MSOP Packages

APPLICATIONS

- Level Translation
- 622-MHz Central Office Clock Distribution
- High-Speed Network Routing
- Wireless Basestations
- Low Jitter Clock Repeater⁽¹⁾

(1) The signaling rate of a line is the number of voltage transitions that are made per second expressed in the units bps (bits per second).

FUNCTIONAL DIAGRAM

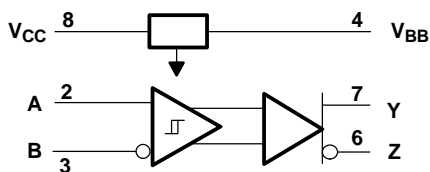

DESCRIPTION

This high-speed translator/repeater is designed for signaling rates up to 1.5 Gbps to support various high-speed network routing applications. The driver output is compatible with current-mode logic (CML) levels, and directly drives 50-Ω or 25-Ω loads connected to 1.8-V, 2.5-V, or 3.3-V nominal supplies. The capability for direct connection to the loads may eliminate the need for coupling capacitors. The receiver input is compatible with LVDS (TIA/EIA-644), LVPECL, and CML signaling levels. The receiver tolerates a wide common-mode voltage range, and may also be directly coupled to the signal source. The internal data path from input to output is fully differential for low noise generation and low pulse-width distortion.

The V_{BB} pin is an internally generated voltage supply to allow operation with a single-ended LVPECL input. For single-ended LVPECL input operation, the unused differential input is connected to V_{BB} as a switching reference voltage. When used, decouple V_{BB} with a 0.01-μF capacitor and limit the current sourcing or sinking to 400 μA. When not used, V_{BB} should be left open.

This device is characterized for operation from -40°C to 85°C.

EYE PATTERN

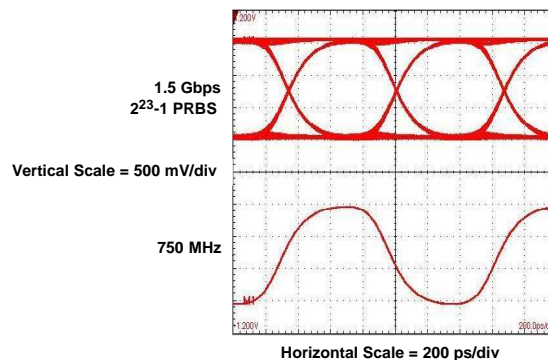

$V_{CC} = 3.3\text{ V}$, $T_A = 25^\circ\text{C}$, $|V_{ID}| = 200\text{ mV}$, $V_{IC} = 1.2\text{ V}$, $V_{TT} = 3.3\text{ V}$, $R_T = 50\ \Omega$



Please be aware that an important notice concerning availability, standard warranty, and use in critical applications of Texas Instruments semiconductor products and disclaimers thereto appears at the end of this data sheet.



These devices have limited built-in ESD protection. The leads should be shorted together or the device placed in conductive foam during storage or handling to prevent electrostatic damage to the MOS gates.

ORDERING INFORMATION

PART NUMBER	PART MARKING	PACKAGE	STATUS
SN65CML100D	CML100	SOIC	Production
SN65CML100DGK	NWB	MSOP	Production

ABSOLUTE MAXIMUM RATINGS

over operating free-air temperature range unless otherwise noted⁽¹⁾

		UNIT	
V_{CC}	Supply voltage range ⁽²⁾	–0.5 V to 4 V	
I_{BB}	Sink/source	±0.5 mA	
	Voltage range, (A, B, Y, Z)	0 V to 4.3 V	
Electrostatic discharge	Human Body Model ⁽³⁾	A, B, Y, Z, and GND	±5 kV
		All pins	±2 kV
	Charged-Device Model ⁽⁴⁾	All pins	±1500 V
	Continuous power dissipation	See Dissipation Rating Table	
T_{stg}	Storage temperature range	–65°C to 150°C	
	Lead temperature 1,6 mm (1/16 inch) from case for 10 seconds	260°C	

- (1) Stresses beyond those listed under *absolute maximum ratings* may cause permanent damage to the device. These are stress ratings only, and functional operation of the device at these or any other conditions beyond those indicated under *recommended operating conditions* is not implied. Exposure to absolute-maximum-rated conditions for extended periods may affect device reliability.
- (2) All voltage values, except differential I/O bus voltages, are with respect to network ground terminal.
- (3) Tested in accordance with JEDEC Standard 22, Test Method A114-A.7.
- (4) Tested in accordance with JEDEC Standard 22, Test Method C101.

RECOMMENDED OPERATING CONDITIONS

		MIN	NOM	MAX	UNIT		
V_{CC}	Supply voltage	3	3.3	3.6	V		
V_{TT}	Terminator supply voltage	3.3-V nominal supply at terminator		3	3.3	3.6	V
		2.5-V nominal supply at terminator		2.375	2.5	2.625	
		1.8-V nominal supply at terminator		1.7		1.9	V
$ V_{ID} $	Magnitude of differential input voltage	0.1		1	V		
	Input voltage (any combination of common-mode or input signals)	0		4	V		
V_{BB}	Output current			400	μA		
T_A	Operating free-air temperature	–40		85	°C		

PACKAGE DISSIPATION RATINGS

PACKAGE	$T_A \leq 25^\circ\text{C}$ POWER RATING	DERATING FACTOR ⁽¹⁾ ABOVE $T_A = 25^\circ\text{C}$	$T_A = 85^\circ\text{C}$ POWER RATING
DGK	425 mW	3.4 mW/°C	221 mW
D	725 mW	5.8 mW/°C	377 mW

- (1) This is the inverse of the junction-to-ambient thermal resistance when board-mounted and with no air flow.

DEVICE CHARACTERISTICS

PARAMETER		MIN	NOM	MAX	UNIT
I_{CC}	Supply current, device only		9	12	mA
V_{BB}	Switching reference voltage ⁽¹⁾	1890	1950	2010	mV

(1) V_{BB} parameter varies 1:1 with V_{CC}

INPUT ELECTRICAL CHARACTERISTICS

over recommended operating conditions (unless otherwise noted)

PARAMETER		TEST CONDITIONS		MIN	TYP ⁽¹⁾	MAX	UNIT
V_{IT+}	Positive-going differential input voltage threshold	See Figure 1 and Table 1				100	mV
V_{IT-}	Negative-going differential input voltage threshold			-100			
$V_{ID(HYS)}$	Differential input voltage hysteresis, $V_{IT+} - V_{IT-}$					25	mV
I_I	Input current (A or B inputs)	$V_I = 0$ V or 2.4 V, Second input at 1.2 V		-20			μ A
		$V_I = 4$ V, Second input at 1.2 V				33	
$I_{I(OFF)}$	Power off input current (A or B inputs)	$V_{CC} = 1.5$ V, $V_I = 0$ V or 2.4 V, Second input at 1.2 V		-20			μ A
		$V_{CC} = 1.5$ V, $V_I = 4$ V, Second input at 1.2 V				33	
I_{IO}	Input offset current ($ I_{IA} - I_{IB} $)	$V_{IA} = V_{IB}$, $0 \leq V_{IA} \leq 4$ V		-6			μ A
C_i	Differential input capacitance	$V_I = 0.4 \sin(4E6\pi t) + 0.5$ V				3	pF
		$V_{CC} = 0$ V				3	

(1) All typical values are at 25°C and with a 3.3-V supply.

OUTPUT ELECTRICAL CHARACTERISTICS

over recommended operating conditions (unless otherwise noted)

PARAMETER		TEST CONDITIONS		MIN	TYP ⁽¹⁾	MAX	UNIT
V_{OH}	Output high voltage ⁽²⁾	$R_T = 50 \Omega$, $V_{TT} = 3$ V to 3.6 V or $V_{TT} = 2.5$ V $\pm 5\%$, See Figure 2	$V_{TT} - 60$	$V_{TT} - 10$	V_{TT}		mV
V_{OL}	Output low voltage ⁽²⁾		$V_{TT} - 1100$	$V_{TT} - 800$	$V_{TT} - 640$		mV
$ V_{OD} $	Differential output voltage magnitude		640	780	1000		mV
V_{OH}	Output high voltage ⁽³⁾	$R_T = 25 \Omega$, $V_{TT} = 3$ V to 3.6 V or $V_{TT} = 2.5$ V $\pm 5\%$, See Figure 2	$V_{TT} - 60$	$V_{TT} - 10$	V_{TT}		mV
V_{OL}	Output low voltage ⁽³⁾		$V_{TT} - 550$	$V_{TT} - 400$	$V_{TT} - 320$		mV
$ V_{OD} $	Differential output voltage magnitude		320	390	500		mV
V_{OH}	Output high voltage ⁽²⁾	$R_T = 50 \Omega$, $V_{TT} = 1.8$ V $\pm 5\%$, See Figure 2	$V_{TT} - 170$	$V_{TT} - 10$	V_{TT}		mV
V_{OL}	Output low voltage ⁽²⁾		$V_{TT} - 1100$	$V_{TT} - 800$	$V_{TT} - 640$		mV
$ V_{OD} $	Differential output voltage magnitude		570	780	1000		mV
V_{OH}	Output high voltage ⁽³⁾	$R_T = 25 \Omega$, $V_{TT} = 1.8$ V $\pm 5\%$, See Figure 2	$V_{TT} - 85$	$V_{TT} - 10$	V_{TT}		mV
V_{OL}	Output low voltage ⁽³⁾		$V_{TT} - 500$	$V_{TT} - 400$	$V_{TT} - 320$		mV
$ V_{OD} $	Differential output voltage magnitude		285	390	500		mV
C_o	Differential output capacitance	$V_I = 0.4 \sin(4E6\pi t) + 0.5$ V				3	pF
		$V_{CC} = 0$ V				3	

(1) All typical values are at 25°C and with a 3.3-V supply.

(2) Outputs are terminated through 50- Ω resistors to V_{TT} ; CML level specifications are referenced to V_{TT} and tracks 1:1 with variation of V_{TT} .

(3) Outputs are terminated through 25- Ω resistors to V_{TT} ; CML level specifications are referenced to V_{TT} and tracks 1:1 with variation of V_{TT} .

SWITCHING CHARACTERISTICS

over recommended operating conditions (unless otherwise noted)

PARAMETER		TEST CONDITIONS	MIN	NOM ⁽¹⁾	MAX	UNIT
t_{PLH}	Propagation delay time, low-to-high-level output	$R_T = 50 \Omega$ or $R_T = 25 \Omega$, See Figure 4	250		800	ps
t_{PHL}	Propagation delay time, high-to-low-level output		250		800	ps
t_r	Differential output signal rise time (20%–80%)				300	ps
t_f	Differential output signal fall time (20%–80%)				300	ps
$t_{sk(p)}$	Pulse skew ($ t_{PHL} - t_{PLH} $) ⁽²⁾			0	50	ps
$t_{sk(pp)}$	Part-to-part skew ⁽³⁾	$V_{ID} = 0.2 V$			100	ps
$t_{jit(per)}$	Period jitter, rms (1 standard deviation) ⁽⁴⁾	750 MHz clock input ⁽⁵⁾		1	5	ps
$t_{jit(cc)}$	Cycle-to-cycle jitter (peak) ⁽⁴⁾	750 MHz clock input ⁽⁶⁾		8	27	ps
$t_{jit(pp)}$	Peak-to-peak jitter ⁽⁴⁾	1.5 Gbps 2 ²³ -1 PRBS input ⁽⁷⁾		30	70	ps
$t_{jit(det)}$	Deterministic jitter, peak-to-peak ⁽⁴⁾	1.5 Gbps 2 ⁷ -1 PRBS input ⁽⁸⁾		25	65	ps

- (1) All typical values are at 25°C and with a 3.3-V supply.
- (2) $t_{sk(p)}$ is the magnitude of the time difference between the t_{PLH} and t_{PHL} .
- (3) $t_{sk(pp)}$ is the magnitude of the difference in propagation delay times between any specified terminals of two devices when both devices operate with the same supply voltages, at the same temperature, and have identical packages and test circuits.
- (4) Jitter parameters are ensured by design and characterization. Measurements are made with a Tektronix TDS6604 oscilloscope running Tektronix TDSJIT3 software. Agilent E4862B stimulus system jitter 2 ps $t_{jit(per)}$, 16 ps $t_{jit(cc)}$, 25 ps $t_{jit(pp)}$, and 10 ps $t_{jit(det)}$ has been subtracted from the values.
- (5) $V_{ID} = 200 mV$, 50% duty cycle, $V_{IC} = 1.2 V$, $t_r = t_f \leq 25 ns$ (20% to 80%), measured over 1000 samples.
- (6) $V_{ID} = 200 mV$, 50% duty cycle, $V_{IC} = 1.2 V$, $t_r = t_f \leq 25 ns$ (20% to 80%).
- (7) $V_{ID} = 200 mV$, $V_{IC} = 1.2 V$, $t_r = t_f \leq 0.25 ns$ (20% to 80%), measured over 100k samples.
- (8) $V_{ID} = 200 mV$, $V_{IC} = 1.2 V$, $t_r = t_f \leq 0.25 ns$ (20% to 80%). Deterministic jitter is sum of pattern dependent jitter and pulse width distortion.

PARAMETER MEASUREMENT INFORMATION

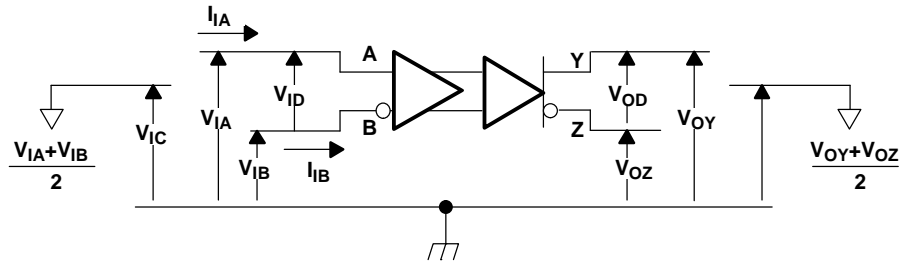

Figure 1. Voltage and Current Definitions

Table 1. Maximum Receiver Input Voltage Threshold

APPLIED VOLTAGES		RESULTING DIFFERENTIAL INPUT VOLTAGE	RESULTING COMMON-MODE INPUT VOLTAGE	OUTPUT ⁽¹⁾
V _{IA}	V _{IB}	V _{ID}	V _{IC}	
1.25 V	1.15 V	100 mV	1.2 V	H
1.15 V	1.25 V	-100 mV	1.2 V	L
4.0 V	3.9 V	100 mV	3.95 V	H
3.9 V	4.0 V	-100 mV	3.95 V	L
0.1 V	0.0 V	100 mV	0.5 V	H
0.0 V	0.1 V	-100 mV	0.5 V	L
1.7 V	0.7 V	1000 mV	1.2 V	H
0.7 V	1.7 V	-1000 mV	1.2 V	L
4.0 V	3.0 V	1000 mV	3.5 V	H
3.0 V	4.0 V	-1000 mV	3.5 V	L
1.0 V	0.0 V	1000 mV	0.5 V	H
0.0 V	1.0 V	-1000 mV	0.5 V	L

(1) H = high level, L = low level

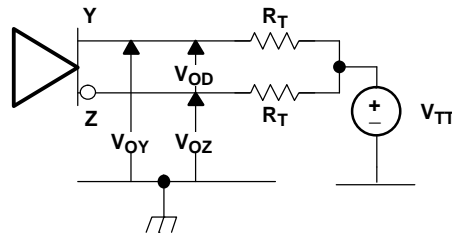

Figure 2. Output Voltage Test Circuit

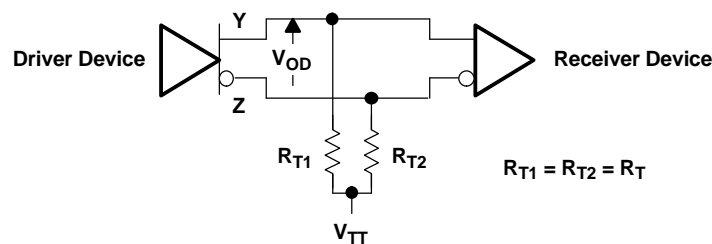
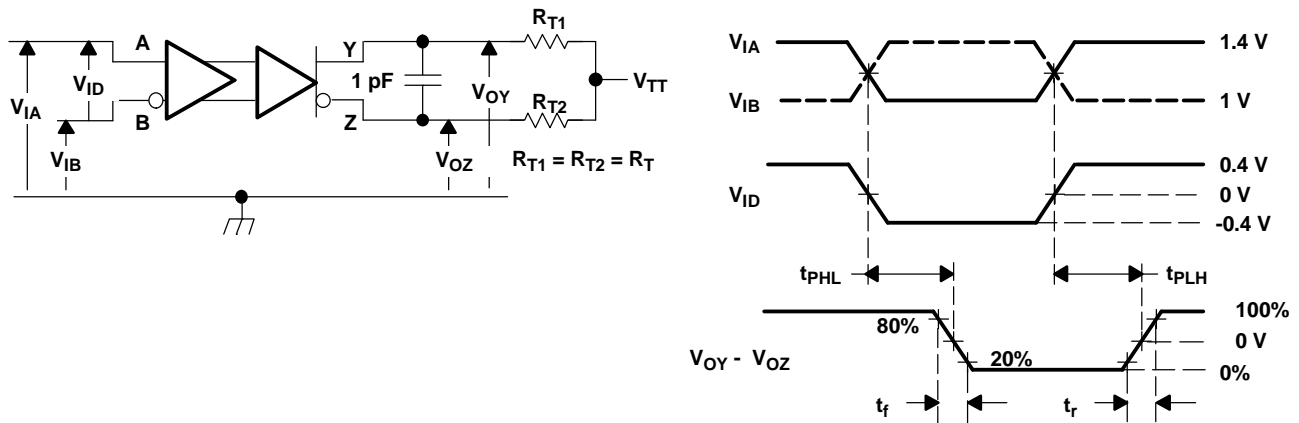

Figure 3. Typical Termination for Output Driver



NOTE: All input pulses are supplied by a generator having the following characteristics: t_r or $t_f \leq 0.25$ ns, pulse repetition rate (PRR) = 50 Mpps, pulse width = 10 ± 0.2 ns. C_L includes instrumentation and fixture capacitance within 0,06 mm of the D.U.T. Measurement equipment provides a bandwidth of 5 GHz minimum.

Figure 4. Timing Test Circuit and Waveforms

PIN ASSIGNMENTS

D AND DGK PACKAGE
(TOP VIEW)

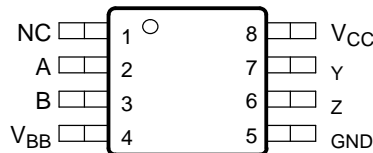

Table 2. PIN DESCRIPTIONS

PIN	FUNCTION
A, B	Differential inputs
Y, Z	Differential outputs
V_{BB}	Reference voltage output
V_{CC}	Power supply
GND	Ground
NC	No connect

Table 3. FUNCTION TABLE

DIFFERENTIAL INPUT	OUTPUTS ⁽¹⁾	
$V_{ID} = V_A - V_B$	Y	Z
$V_{ID} \geq 100$ mV	H	L
-100 mV < V_{ID} < 100 mV	?	?
$V_{ID} \leq -100$ mV	L	H
Open	?	?

(1) H = high level, L = low level, ? = intermediate

EQUIVALENT INPUT AND OUTPUT SCHEMATIC DIAGRAMS

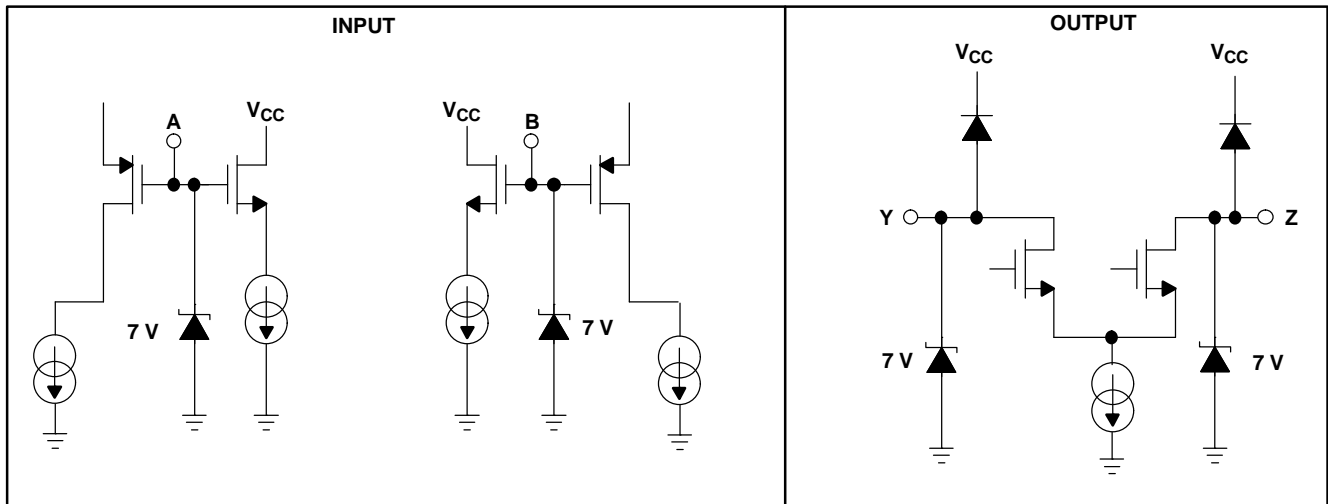

TYPICAL CHARACTERISTICS

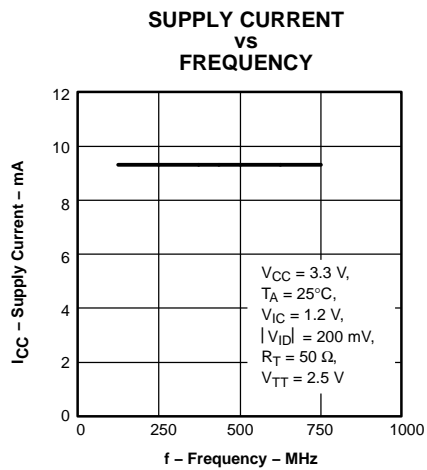

Figure 5.

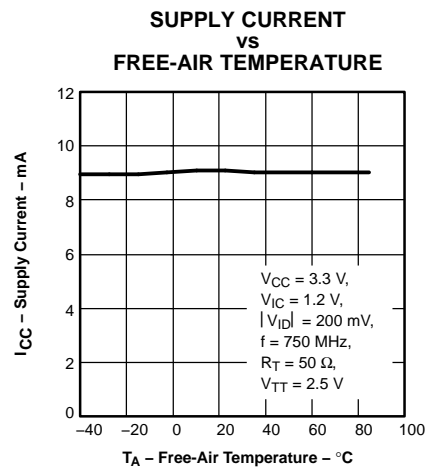

Figure 6.

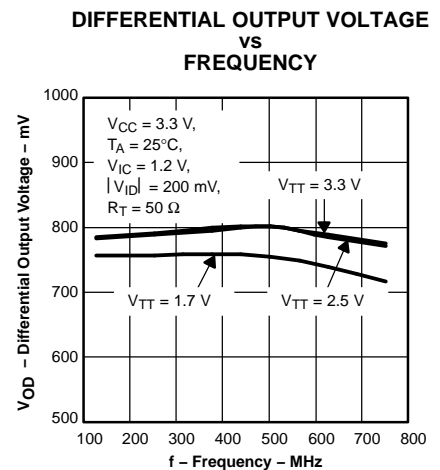

Figure 7.

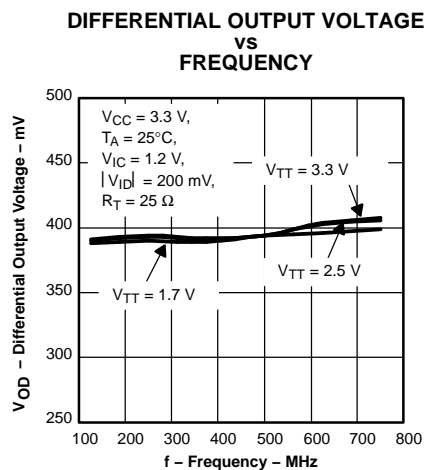

Figure 8.

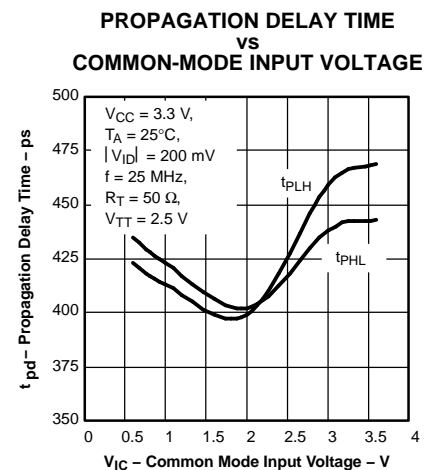

Figure 9.

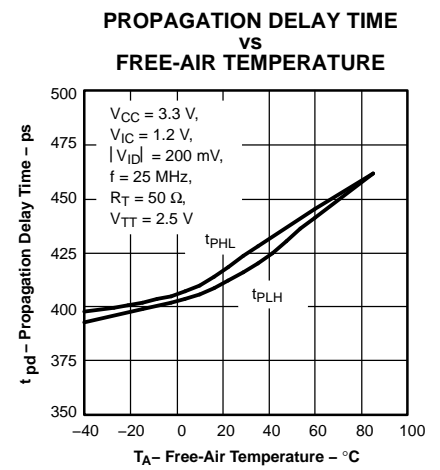

Figure 10.

TYPICAL CHARACTERISTICS (continued)

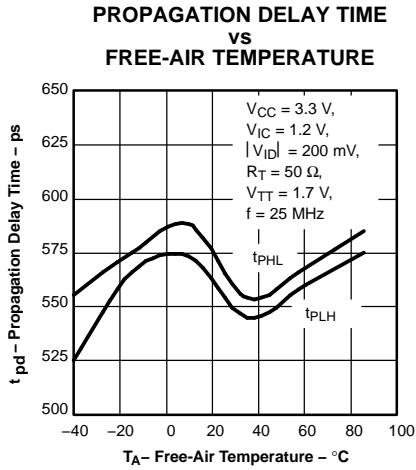

Figure 11.

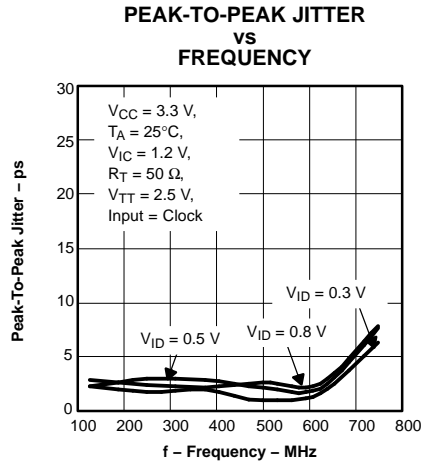

Figure 12.

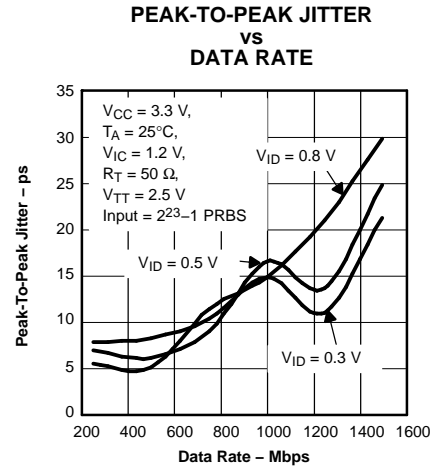

Figure 13.

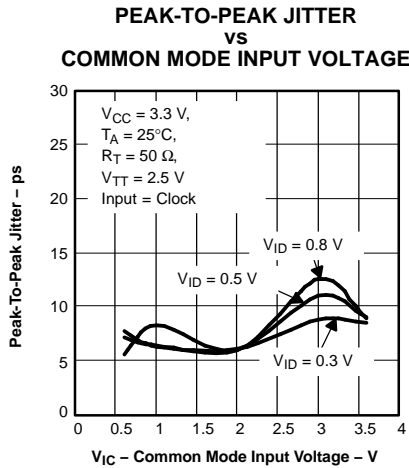

Figure 14.

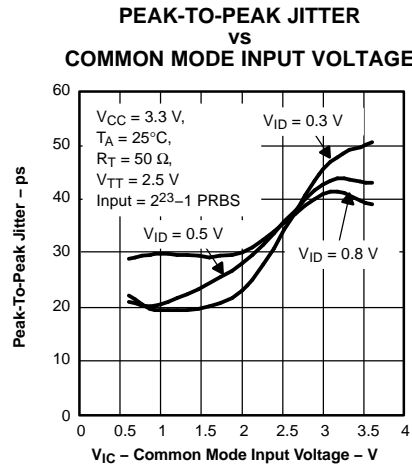

Figure 15.

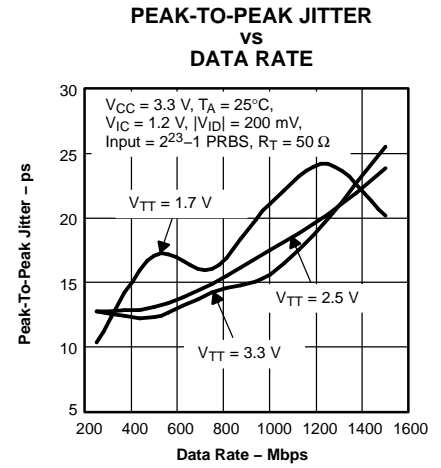

Figure 16.

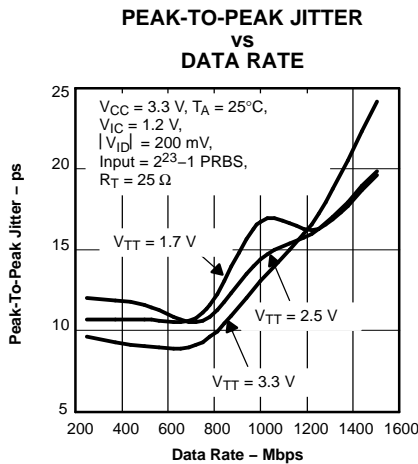

Figure 17.

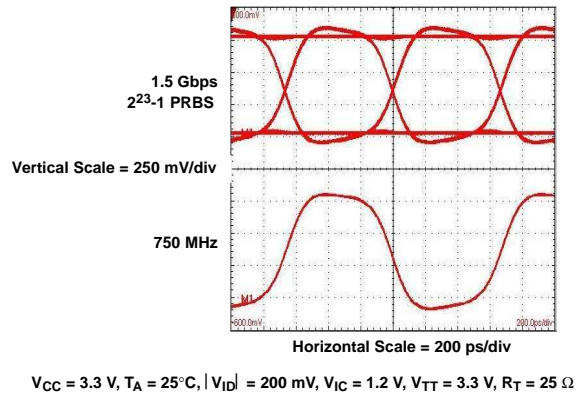

Figure 18.

TYPICAL CHARACTERISTICS (continued)

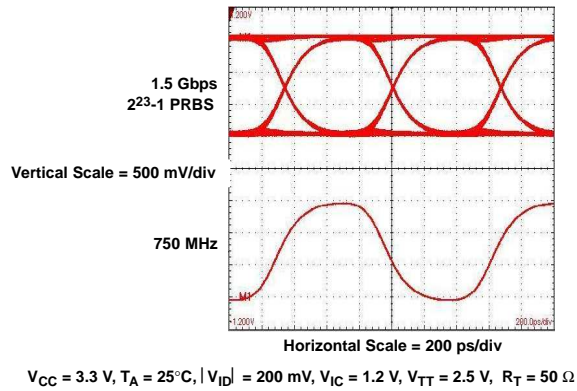

Figure 19.

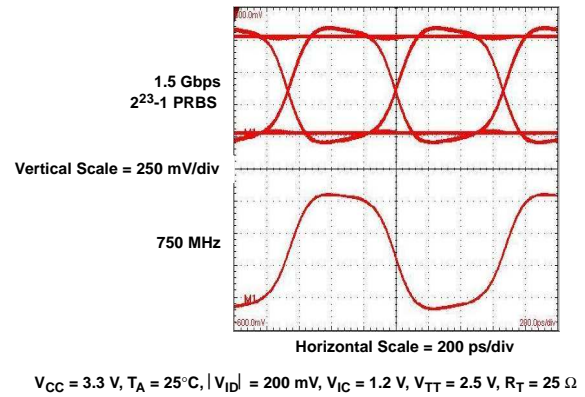

Figure 20.

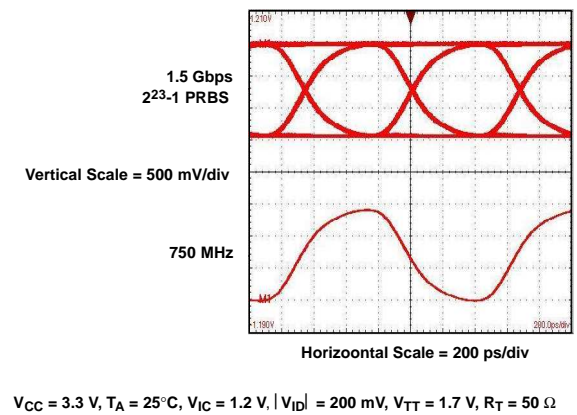

Figure 21.

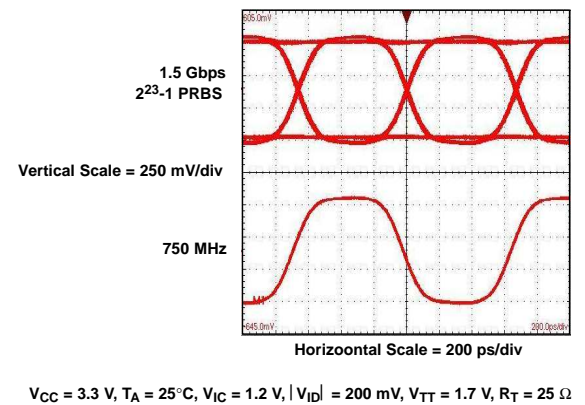

Figure 22.

TYPICAL CHARACTERISTICS (continued)

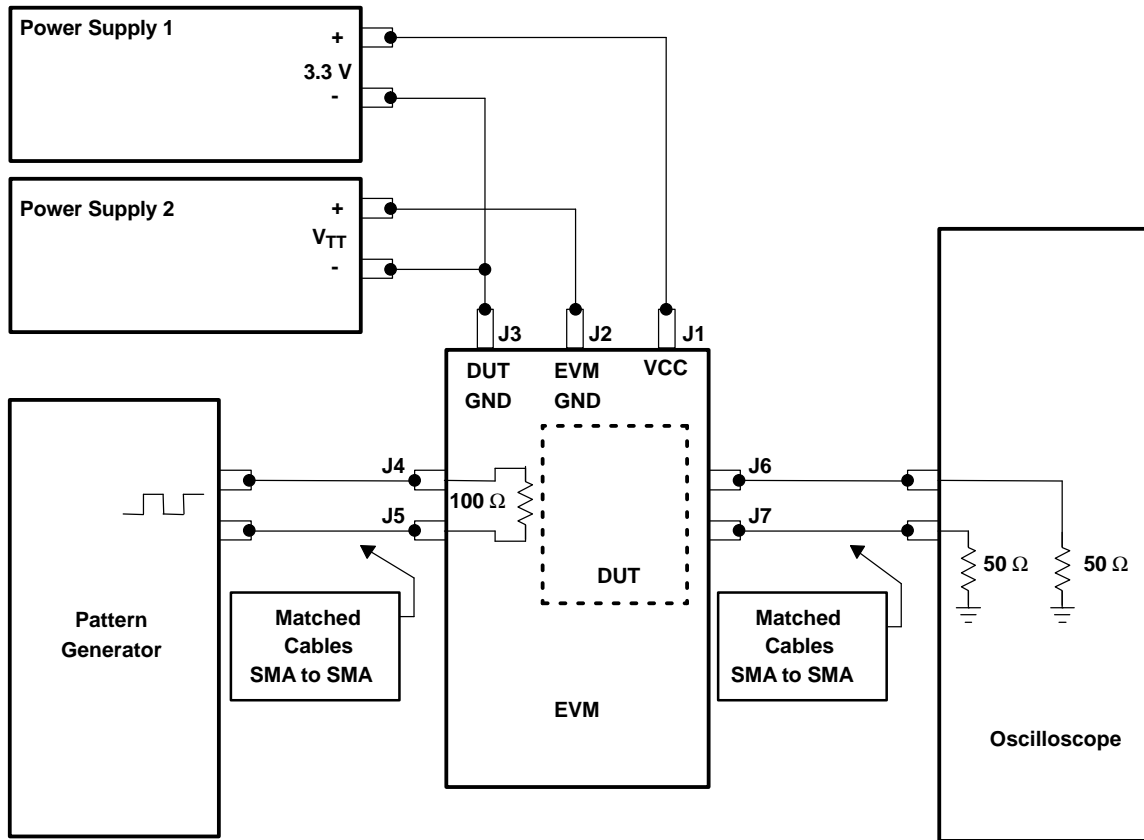

Figure 23. Jitter Setup Connections for SN65CML100

APPLICATION INFORMATION

For single-ended input conditions, the unused differential input is connected to V_{BB} as a switching reference voltage. When V_{BB} is used, decouple V_{BB} via a 0.01- μF capacitor and limit the current sourcing or sinking to 0.4 mA. When not used, V_{BB} should be left open.

TYPICAL APPLICATION CIRCUITS (ECL, PECL, LVDS, etc.)

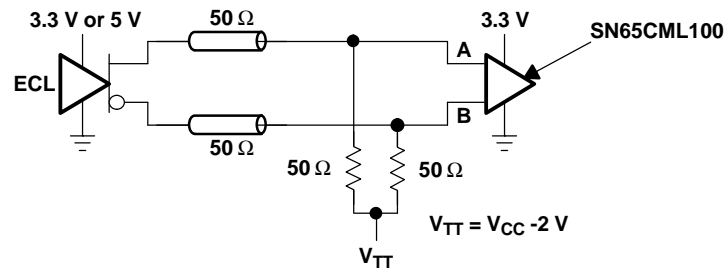

Figure 24. Low-Voltage Positive Emitter-Coupled Logic (LVPECL)

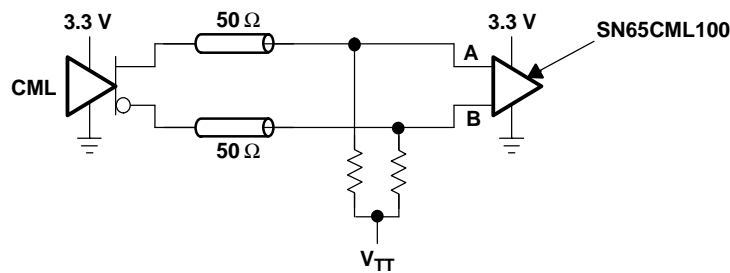

Figure 25. Current-Mode Logic (CML)

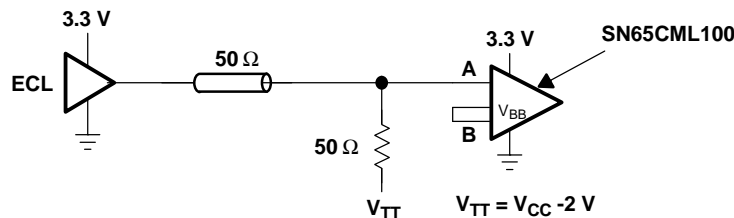

Figure 26. Single-Ended (LVPECL)

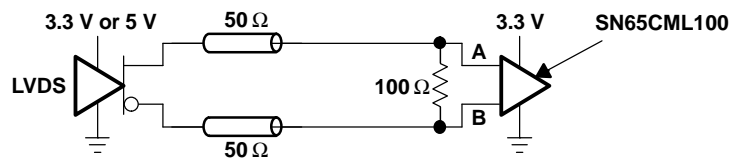

Figure 27. Low-Voltage Differential Signaling (LVDS)

PACKAGING INFORMATION

Orderable Device	Status (1)	Package Type	Package Drawing	Pins	Package Qty	Eco Plan (2)	Lead finish/ Ball material (6)	MSL Peak Temp (3)	Op Temp (°C)	Device Marking (4/5)	Samples
SN65CML100D	ACTIVE	SOIC	D	8	75	RoHS & Green	NIPDAU	Level-1-260C-UNLIM	-40 to 85	CML100	Samples
SN65CML100DGK	ACTIVE	VSSOP	DGK	8	80	RoHS & Green	NIPDAU	Level-1-260C-UNLIM	-40 to 85	NWB	Samples
SN65CML100DGKG4	ACTIVE	VSSOP	DGK	8	80	RoHS & Green	NIPDAU	Level-1-260C-UNLIM	-40 to 85	NWB	Samples
SN65CML100DGKR	ACTIVE	VSSOP	DGK	8	2500	RoHS & Green	NIPDAU	Level-1-260C-UNLIM	-40 to 85	NWB	Samples
SN65CML100DR	ACTIVE	SOIC	D	8	2500	RoHS & Green	NIPDAU	Level-1-260C-UNLIM	-40 to 85	CML100	Samples

(1) The marketing status values are defined as follows:

ACTIVE: Product device recommended for new designs.

LIFEBUY: TI has announced that the device will be discontinued, and a lifetime-buy period is in effect.

NRND: Not recommended for new designs. Device is in production to support existing customers, but TI does not recommend using this part in a new design.

PREVIEW: Device has been announced but is not in production. Samples may or may not be available.

OBSELETE: TI has discontinued the production of the device.

(2) **RoHS:** TI defines "RoHS" to mean semiconductor products that are compliant with the current EU RoHS requirements for all 10 RoHS substances, including the requirement that RoHS substance do not exceed 0.1% by weight in homogeneous materials. Where designed to be soldered at high temperatures, "RoHS" products are suitable for use in specified lead-free processes. TI may reference these types of products as "Pb-Free".

RoHS Exempt: TI defines "RoHS Exempt" to mean products that contain lead but are compliant with EU RoHS pursuant to a specific EU RoHS exemption.

Green: TI defines "Green" to mean the content of Chlorine (Cl) and Bromine (Br) based flame retardants meet JS709B low halogen requirements of <=1000ppm threshold. Antimony trioxide based flame retardants must also meet the <=1000ppm threshold requirement.

(3) MSL, Peak Temp. - The Moisture Sensitivity Level rating according to the JEDEC industry standard classifications, and peak solder temperature.

(4) There may be additional marking, which relates to the logo, the lot trace code information, or the environmental category on the device.

(5) Multiple Device Markings will be inside parentheses. Only one Device Marking contained in parentheses and separated by a "~" will appear on a device. If a line is indented then it is a continuation of the previous line and the two combined represent the entire Device Marking for that device.

(6) Lead finish/Ball material - Orderable Devices may have multiple material finish options. Finish options are separated by a vertical ruled line. Lead finish/Ball material values may wrap to two lines if the finish value exceeds the maximum column width.

Important Information and Disclaimer:The information provided on this page represents TI's knowledge and belief as of the date that it is provided. TI bases its knowledge and belief on information provided by third parties, and makes no representation or warranty as to the accuracy of such information. Efforts are underway to better integrate information from third parties. TI has taken and continues to take reasonable steps to provide representative and accurate information but may not have conducted destructive testing or chemical analysis on incoming materials and chemicals. TI and TI suppliers consider certain information to be proprietary, and thus CAS numbers and other limited information may not be available for release.

In no event shall TI's liability arising out of such information exceed the total purchase price of the TI part(s) at issue in this document sold by TI to Customer on an annual basis.

TAPE AND REEL INFORMATION

QUADRANT ASSIGNMENTS FOR PIN 1 ORIENTATION IN TAPE

*All dimensions are nominal

Device	Package Type	Package Drawing	Pins	SPQ	Reel Diameter (mm)	Reel Width W1 (mm)	A0 (mm)	B0 (mm)	K0 (mm)	P1 (mm)	W (mm)	Pin1 Quadrant
SN65CML100DGKR	VSSOP	DGK	8	2500	330.0	12.4	5.3	3.4	1.4	8.0	12.0	Q1
SN65CML100DR	SOIC	D	8	2500	330.0	12.4	6.4	5.2	2.1	8.0	12.0	Q1

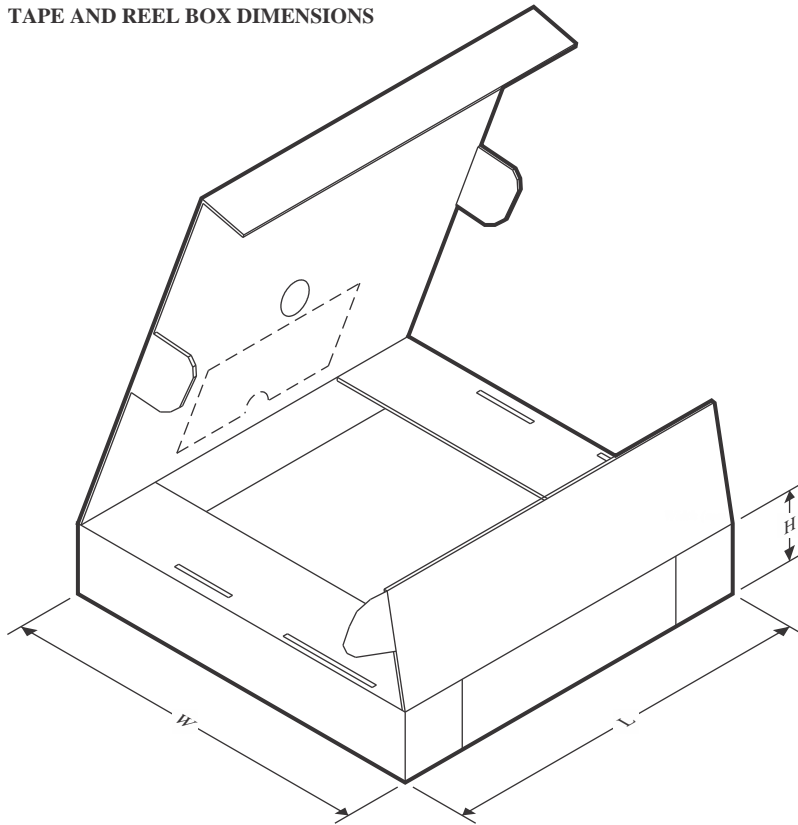
TAPE AND REEL BOX DIMENSIONS

*All dimensions are nominal

Device	Package Type	Package Drawing	Pins	SPQ	Length (mm)	Width (mm)	Height (mm)
SN65CML100DGKR	VSSOP	DGK	8	2500	358.0	335.0	35.0
SN65CML100DR	SOIC	D	8	2500	340.5	336.1	25.0

TUBE

*All dimensions are nominal

Device	Package Name	Package Type	Pins	SPQ	L (mm)	W (mm)	T (μm)	B (mm)
SN65CML100D	D	SOIC	8	75	505.46	6.76	3810	4
SN65CML100D	D	SOIC	8	75	507	8	3940	4.32

DGK0008A

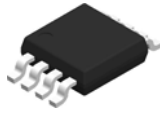

PACKAGE OUTLINE

VSSOP - 1.1 mm max height

SMALL OUTLINE PACKAGE

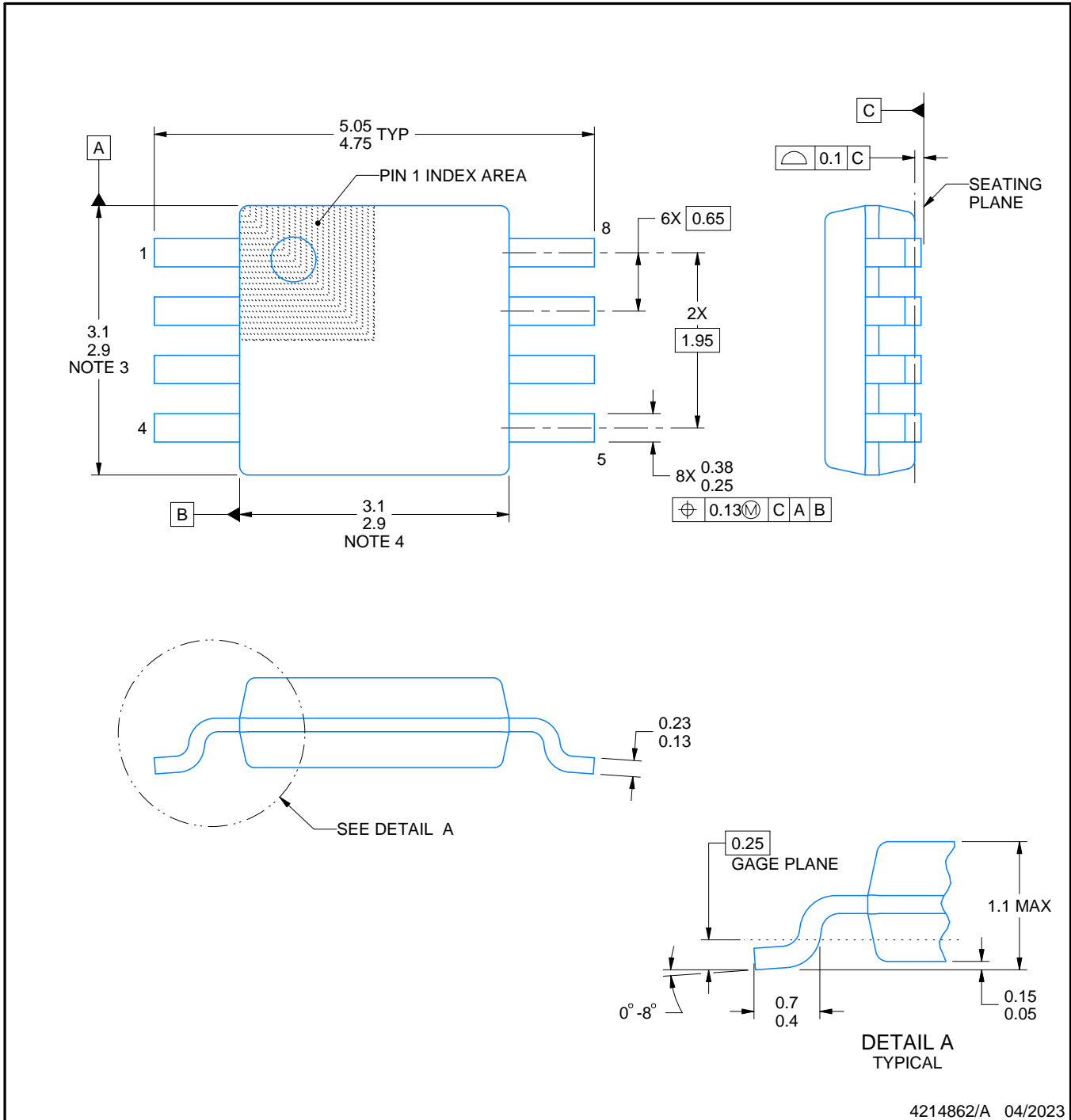

4214862/A 04/2023

NOTES:

PowerPAD is a trademark of Texas Instruments.

- All linear dimensions are in millimeters. Any dimensions in parenthesis are for reference only. Dimensioning and tolerancing per ASME Y14.5M.
- This drawing is subject to change without notice.
- This dimension does not include mold flash, protrusions, or gate burrs. Mold flash, protrusions, or gate burrs shall not exceed 0.15 mm per side.
- This dimension does not include interlead flash. Interlead flash shall not exceed 0.25 mm per side.
- Reference JEDEC registration MO-187.

EXAMPLE BOARD LAYOUT

DGK0008A

™ VSSOP - 1.1 mm max height

SMALL OUTLINE PACKAGE

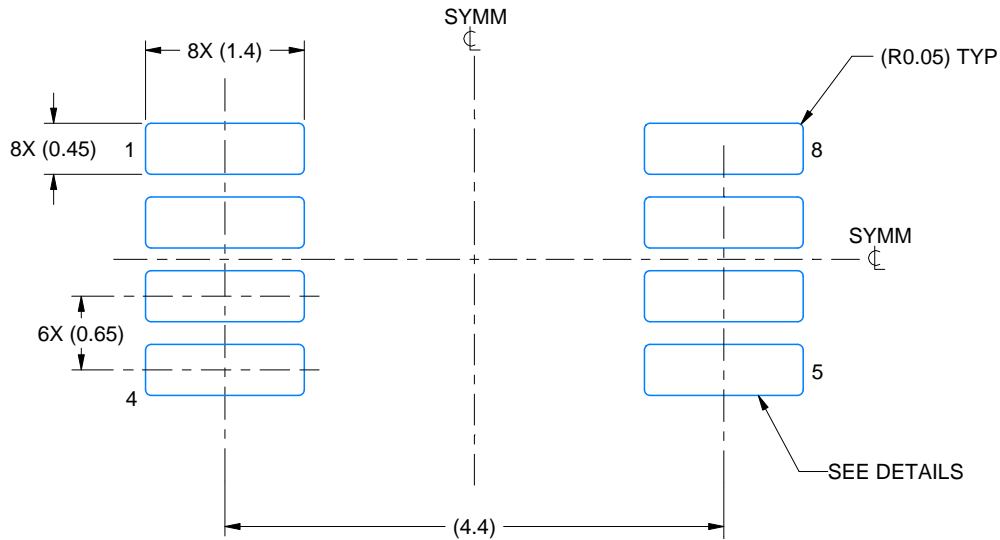

LAND PATTERN EXAMPLE
EXPOSED METAL SHOWN
SCALE: 15X

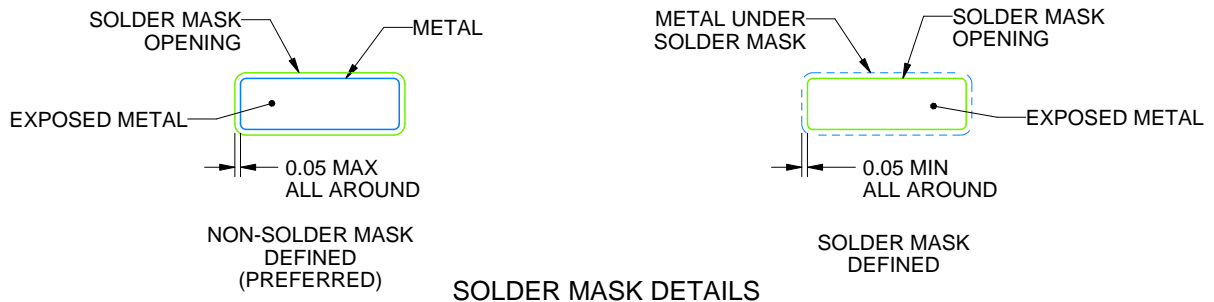

SOLDER MASK DETAILS

4214862/A 04/2023

NOTES: (continued)

6. Publication IPC-7351 may have alternate designs.
7. Solder mask tolerances between and around signal pads can vary based on board fabrication site.
8. Vias are optional depending on application, refer to device data sheet. If any vias are implemented, refer to their locations shown on this view. It is recommended that vias under paste be filled, plugged or tented.
9. Size of metal pad may vary due to creepage requirement.

EXAMPLE STENCIL DESIGN

DGK0008A

™ VSSOP - 1.1 mm max height

SMALL OUTLINE PACKAGE

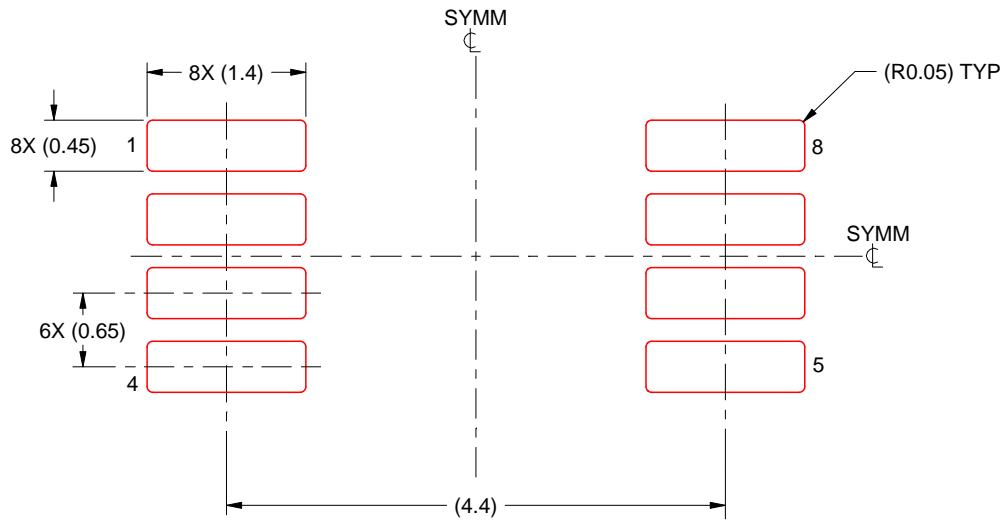

SOLDER PASTE EXAMPLE
SCALE: 15X

4214862/A 04/2023

NOTES: (continued)

11. Laser cutting apertures with trapezoidal walls and rounded corners may offer better paste release. IPC-7525 may have alternate design recommendations.
12. Board assembly site may have different recommendations for stencil design.



D0008A

PACKAGE OUTLINE

SOIC - 1.75 mm max height

SMALL OUTLINE INTEGRATED CIRCUIT



4214825/C 02/2019

NOTES:

- Linear dimensions are in inches [millimeters]. Dimensions in parenthesis are for reference only. Controlling dimensions are in inches. Dimensioning and tolerancing per ASME Y14.5M.
- This drawing is subject to change without notice.
- This dimension does not include mold flash, protrusions, or gate burrs. Mold flash, protrusions, or gate burrs shall not exceed $.006$ [0.15] per side.
- This dimension does not include interlead flash.
- Reference JEDEC registration MS-012, variation AA.

EXAMPLE BOARD LAYOUT

D0008A

SOIC - 1.75 mm max height

SMALL OUTLINE INTEGRATED CIRCUIT



LAND PATTERN EXAMPLE
 EXPOSED METAL SHOWN
 SCALE:8X



SOLDER MASK DETAILS

4214825/C 02/2019

NOTES: (continued)

- 6. Publication IPC-7351 may have alternate designs.
- 7. Solder mask tolerances between and around signal pads can vary based on board fabrication site.

EXAMPLE STENCIL DESIGN

D0008A

SOIC - 1.75 mm max height

SMALL OUTLINE INTEGRATED CIRCUIT



SOLDER PASTE EXAMPLE
BASED ON .005 INCH [0.125 MM] THICK STENCIL
SCALE:8X

4214825/C 02/2019

NOTES: (continued)

8. Laser cutting apertures with trapezoidal walls and rounded corners may offer better paste release. IPC-7525 may have alternate design recommendations.
9. Board assembly site may have different recommendations for stencil design.

IMPORTANT NOTICE AND DISCLAIMER

TI PROVIDES TECHNICAL AND RELIABILITY DATA (INCLUDING DATA SHEETS), DESIGN RESOURCES (INCLUDING REFERENCE DESIGNS), APPLICATION OR OTHER DESIGN ADVICE, WEB TOOLS, SAFETY INFORMATION, AND OTHER RESOURCES "AS IS" AND WITH ALL FAULTS, AND DISCLAIMS ALL WARRANTIES, EXPRESS AND IMPLIED, INCLUDING WITHOUT LIMITATION ANY IMPLIED WARRANTIES OF MERCHANTABILITY, FITNESS FOR A PARTICULAR PURPOSE OR NON-INFRINGEMENT OF THIRD PARTY INTELLECTUAL PROPERTY RIGHTS.

These resources are intended for skilled developers designing with TI products. You are solely responsible for (1) selecting the appropriate TI products for your application, (2) designing, validating and testing your application, and (3) ensuring your application meets applicable standards, and any other safety, security, regulatory or other requirements.

These resources are subject to change without notice. TI grants you permission to use these resources only for development of an application that uses the TI products described in the resource. Other reproduction and display of these resources is prohibited. No license is granted to any other TI intellectual property right or to any third party intellectual property right. TI disclaims responsibility for, and you will fully indemnify TI and its representatives against, any claims, damages, costs, losses, and liabilities arising out of your use of these resources.

TI's products are provided subject to [TI's Terms of Sale](#) or other applicable terms available either on [ti.com](https://www.ti.com) or provided in conjunction with such TI products. TI's provision of these resources does not expand or otherwise alter TI's applicable warranties or warranty disclaimers for TI products.

TI objects to and rejects any additional or different terms you may have proposed.

Mailing Address: Texas Instruments, Post Office Box 655303, Dallas, Texas 75265
Copyright © 2024, Texas Instruments Incorporated

Looking for pricing, stock, or lifecycle information?

Click below to explore more details on WIN SOURCE:

 [View SN65CML100EVM on WIN SOURCE](#)

 [Texas Instruments](#) Information

Optimize Your Supply Chain with WIN SOURCE Solutions

-  Global Sourcing Solution
-  Obsolete Management
-  Cost Control Management
-  Shortage Management
-  Alternative Solution
-  Excess Inventory Management