



**THE DATASHEET OF
RSN-5-100B**



RSN Series

DC Ammeter Shunts / Busbar Shunts

1 Amp - 500 Amp

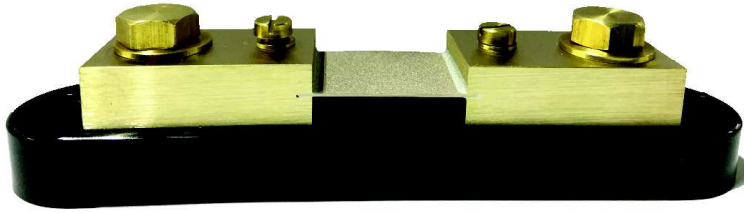
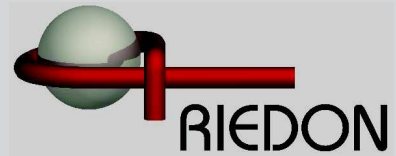

- 1 Amp to 500 Amp
- 0.1% Tolerance
- Manganin Resistive Element
- Calibration Certificate Available
- Common Application:
Power Supply
Power Converters
Current Measurements

SPECIFICATIONS				
Type	Rated Current (A)	Operating Current (A)	Resistance (mΩ) 50mV Output	Resistance (mΩ) 100mV Output
RSN-1	1	0.667	50	100
RSN-2	2	1.33	25	50
RSN-5	5	3.33	10	20
RSN-10	10	6.67	5.0	10
RSN-20	20	13.33	2.5	5.0
RSN-50	50	33.33	1.0	2.0
RSN-100	100	66.67	0.5	1.0
RSN-150	150	100	0.333	0.667
RSN-200	200	133.33	0.25	0.50
RSN-250	250	166.67	0.20	0.40
RSN-300	300	200	0.167	0.333
RSN-400	400	266.67	0.125	0.25
RSN-500	500	333.33	0.10	0.20

SPECIFICATIONS	
Rated Output	50mV, 100mV, Custom
Voltage Tolerance	±0.1%
Operating Temp.	30°C to 70°C
Storage Temp.	-55°C to 80°C
Materials	Resistance Element: Manganin Terminal Block RSN: Brass Base: Bakelite

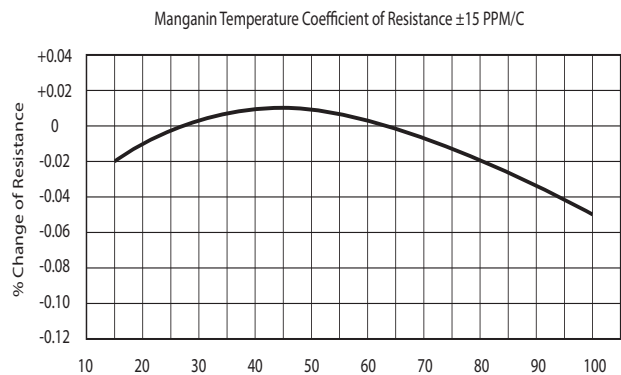

*Applies to resistance element only

Operating Current Derating: For continuous operation, it is recommended that shunts are not run at more than two thirds (2/3) the rated current under normal conditions per IEEE standards for DC instrument shunts. At ambient temperatures above 40°C, the current must be further derated to prevent damage.

RSN Series

DC Ammeter Shunts / Busbar Shunts

1 Amp - 500 Amp

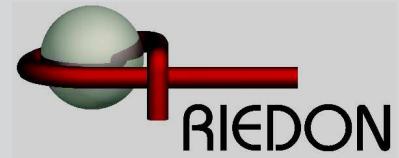

Dimensions (mm)

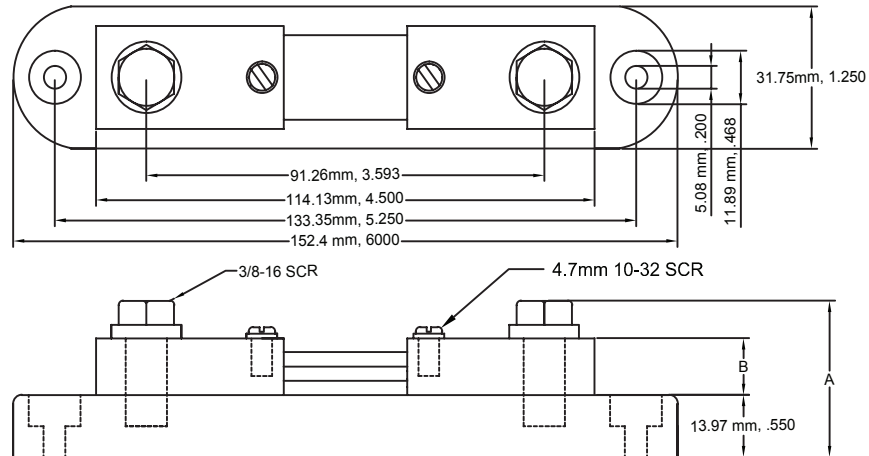

Type	50mV Output		Type	100mV Output	
	A	B		A	B
RSN-1-50	35.05	12.7	RSN-1-100	35.05	12.7
RSN-2-50	35.05	12.7	RSN-2-100	35.05	12.7
RSN-5-50	35.05	12.7	RSN-5-100	35.05	12.7
RSN-10-50	35.05	12.7	RSN-10-100	35.05	12.7
RSN-20-50	35.05	12.7	RSN-20-100	35.05	12.7
RSN-50-50	35.05	12.7	RSN-50-100	35.05	12.7
RSN-100-50	35.05	12.7	RSN-100-100	35.05	12.7
RSN-150-50	35.05	12.7	RSN-150-100	35.05	12.7
RSN-200-50	35.05	12.7	RSN-200-100	35.05	12.7
RSN-250-50	41.40	19.05	RSN-250-100	35.05	12.7
RSN-300-50	41.40	19.05	RSN-300-100	35.05	12.7
RSN-400-50	41.40	19.05	RSN-400-100	41.40	19.05
RSN-500-50	41.40	19.05	RSN-500-100	41.40	19.05

Ordering Information

Part Description: Part Type - Current - Voltage Output (mV)

Example: **RSN - 1 - 50**

RSN Series

DC Ammeter Shunts / Busbar Shunts

1 Amp - 500 Amp

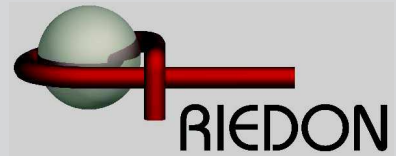

TECHNICAL NOTES

Mounting: Shunts should be mounted with manganin resistive blades in a vertical position in order to promote the free convectional flow of air. If vertical mounting is not practical, forced air cooling or adding heat sinks to the blocks can reduce the operating temperature. The manganin blades must never exceed +145°C, otherwise permanent resistance change may occur.

When current of 100A or greater is passing through the shunt, the major portion of heat generated is dissipated by conduction through the shunt terminal blocks into the connecting buss bar or cable. Therefore it is necessary to insure that good contact is made between the shunt terminal blocks and the conductor terminals and that the conductors have adequate cross section to keep the temperature of the shunt from exceeding 145°C (125°C recommended).

If the shunt is mounted in an enclosure, care must be taken to ensure adequate cooling. If the power density is greater than 1/4 watt per square inch of the enclosure surface for all enclosed devices, additional cooling must be supplied in the form of air vents or fans.

Shunts also must be installed in a way that protects them from thermal expansion forces produced from buss bar or short-circuit forces. Flexible wiring may be required in high pulse current, high vibration, or high temperature applications.

Where possible, all shunts should be mounted on the ground side of the circuit. For circuits above 750VDC, RS shunts **must** be mounted on the ground side due to the dielectric strength of the shunt base.

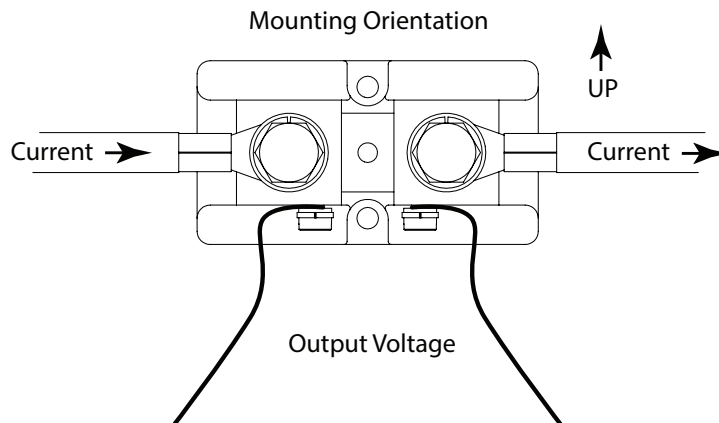

Operating Current Derating: For continuous operation, it is recommended that shunts are not run at more than two thirds (2/3) the rated current under normal conditions per IEEE standards for DC instrument shunts. At ambient temperatures above 40°C, the current must be further derated to prevent damage.

Pulse Operation: Shunts that do not need continuous operation and are only exposed to intermittent pulses can be operated at levels above their rated current for short periods of times. Pulses are limited to the maximum temperature of the blades not exceeding 145°C (125°C recommended). Many variables such as ambient temperature, cross section of the current carrying conductors, and pulse duration make calculating exact values difficult. Shunt size will need to be validated by customer for pulse current and duty cycle on a case by case basis.

Looking for pricing, stock, or lifecycle information?

Click below to explore more details on WIN SOURCE:

 [View RSN-5-100B on WIN SOURCE](#)

 [Riedon Information](#)

Optimize Your Supply Chain with WIN SOURCE Solutions

-  Global Sourcing Solution
-  Obsolete Management
-  Cost Control Management
-  Shortage Management
-  Alternative Solution
-  Excess Inventory Management